

**MIKE 21**  
**Boussinesq Wave Module**  
**Scientific Documentation**



**DHI A/S headquarters**

Agern Allé 5  
DK-2970 Hørsholm  
Denmark

+45 4516 9200 Telephone

[mike@dhigroup.com](mailto:mike@dhigroup.com)

[www.mikepoweredbydhi.com](http://www.mikepoweredbydhi.com)

Company Registration No.: DK36466871

## PLEASE NOTE

### **COPYRIGHT**

This document refers to proprietary computer software, which is protected by copyright. All rights are reserved. Copying or other reproduction of this manual or the related programmes is prohibited without prior written consent of DHI A/S (hereinafter referred to as "DHI"). For details please refer to your 'DHI Software Licence Agreement'.

### **LIMITED LIABILITY**

The liability of DHI is limited as specified in your DHI Software License Agreement:

In no event shall DHI or its representatives (agents and suppliers) be liable for any damages whatsoever including, without limitation, special, indirect, incidental or consequential damages or damages for loss of business profits or savings, business interruption, loss of business information or other pecuniary loss arising in connection with the Agreement, e.g. out of Licensee's use of or the inability to use the Software, even if DHI has been advised of the possibility of such damages.

This limitation shall apply to claims of personal injury to the extent permitted by law. Some jurisdictions do not allow the exclusion or limitation of liability for consequential, special, indirect, incidental damages and, accordingly, some portions of these limitations may not apply.

Notwithstanding the above, DHI's total liability (whether in contract, tort, including negligence, or otherwise) under or in connection with the Agreement shall in aggregate during the term not exceed the lesser of EUR 10.000 or the fees paid by Licensee under the Agreement during the 12 months' period previous to the event giving rise to a claim.

Licensee acknowledge that the liability limitations and exclusions set out in the Agreement reflect the allocation of risk negotiated and agreed by the parties and that DHI would not enter into the Agreement without these limitations and exclusions on its liability. These limitations and exclusions will apply notwithstanding any failure of essential purpose of any limited remedy.

# CONTENTS

## MIKE 21 Boussinesq Wave Module Scientific Documentation

<b>1</b>	<b>Introduction .....</b>	<b>1</b>
1.1	About this Guide.....	1
1.2	What does this Guide Contain? .....	1
<b>2</b>	<b>General Description.....</b>	<b>2</b>
2.1	2DH Boussinesq Wave Module .....	3
2.2	1DH Boussinesq Wave Module .....	5
<b>3</b>	<b>Basic Equations.....</b>	<b>8</b>
3.1	Basic Equations for the 2DH Boussinesq Wave Module .....	8
3.2	Basic Equations for the 1DH Boussinesq Wave Module .....	11
<b>4</b>	<b>Numerical Implementation.....</b>	<b>12</b>
4.1	2DH Boussinesq Wave Module .....	12
4.2	1DH Boussinesq Wave Module .....	13
<b>5</b>	<b>Verification.....</b>	<b>14</b>
5.1	2DH Boussinesq Wave Module .....	14
5.2	1DH Boussinesq Wave Module .....	15
<b>6</b>	<b>References.....</b>	<b>17</b>

# 1 Introduction

## 1.1 About this Guide

The purpose of this document is to provide the user with the scientific background of the Boussinesq Wave Modules included in MIKE 21 BW.

## 1.2 What does this Guide Contain?

The entries listed below are included in the present document as separate sections.

- General Description
- Basic Equations
- Numerical Implementation
- Verification

The papers enclosed in Chapter 6 aim at giving an in-depth description of the physical, mathematical and numerical background related to wave modelling using Boussinesq type equations.

## 2 General Description

The two modules included in MIKE 21 BW are based on the numerical solution of time domain formulations of Boussinesq type equations. The Boussinesq equations include nonlinearity as well as frequency dispersion. Basically, the frequency dispersion is introduced in the momentum equations by taking into account the effect that vertical accelerations have on the pressure distribution.

Both modules solve the Boussinesq type equations using a flux-formulation with improved linear dispersion characteristics. These enhanced Boussinesq type equations (originally derived by Madsen et al, 1991, and Madsen and Sørensen, 1992)<sup>1</sup> make the modules suitable for simulation of the propagation of directional wave trains travelling from deep to shallow water. The maximum depth to deep-water wave length is  $h/L_0 \approx 0.5$  (or  $kh \approx 3.1$ , where  $kh$  is the relative wave number). For the classical Boussinesq equations (e.g. Peregrine, 1967)<sup>2</sup> the maximum depth to deep-water wave length is  $h/L_0 \approx 0.22$  (or  $kh \approx 1.4$ ).

The model equations have been extended to take into account of wave breaking and moving shoreline as described in Madsen et al (1997a,b)<sup>3</sup> and Sørensen et al (1998, 2004)<sup>3</sup>.

The MIKE 21 BW version includes the two modules:

- 2DH Boussinesq wave module
- 1DH Boussinesq wave module

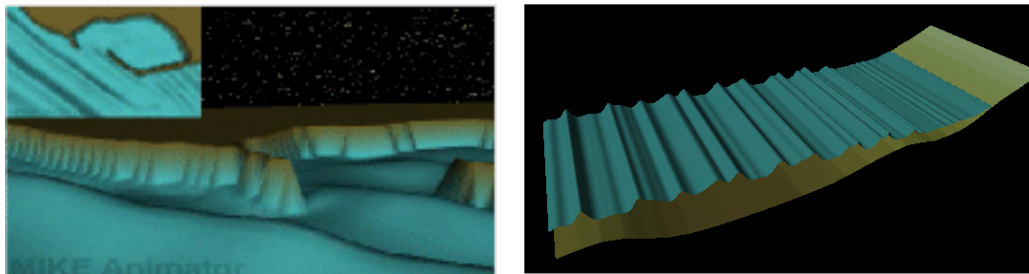

Figure 2.1 The MIKE 21 BW includes two wave modules. The 2DH module (left panel) is traditionally applied for calculation of wave disturbance in ports and harbours and coastal areas. The 1DH module (right panel) is selected for calculation of wave transformation from offshore to the beach for study of the surf zone and swash zone dynamics

<sup>1</sup> A copy of these papers is included in the MIKE installation

<sup>2</sup> Peregrine, D H (1967), Long waves on a beach. J.Fluid Mech., **27**, 4, 815-827

<sup>3</sup> A copy of these papers is included in the MIKE installation

## 2.1 2DH Boussinesq Wave Module

The 2DH module (two horizontal space co-ordinates) solves the enhanced Boussinesq equations by an implicit finite difference technique with variables defined on a space-staggered rectangular grid. The module is capable of reproducing the combined effects of most wave phenomena of interest in port, harbour and coastal engineering. These include:

- Shoaling
- Refraction
- Diffraction
- Wave Breaking
- Bottom Friction
- Moving Shoreline
- Partial Reflection and Transmission
- Non-linear Wave-Wave Interaction
- Frequency Spreading
- Directional Spreading

Phenomena, such as wave grouping, surf beats, generation of bound sub-harmonics and super-harmonics and near-resonant triad interactions, can also be modelled using MIKE 21 BW. Thus, details like the generation and release of low-frequency oscillations due to primary wave transformation are well described in the model. This is of significant important for harbour resonance, seiching and coastal processes.

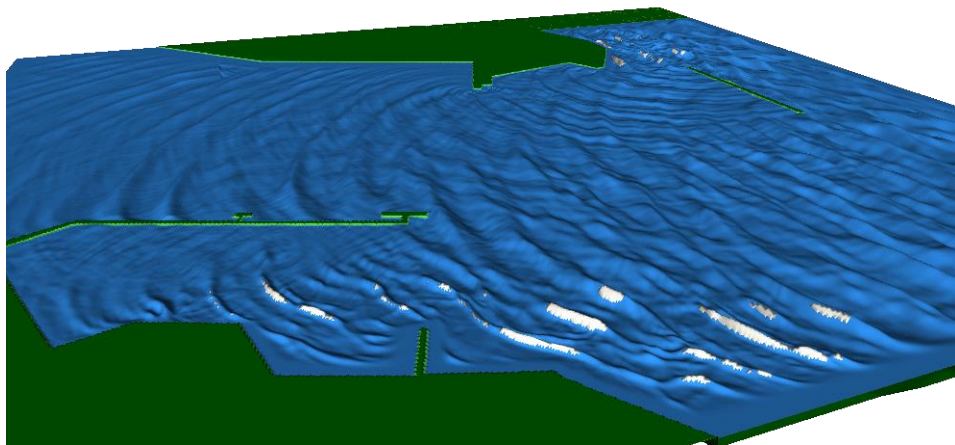

Figure 2.2 Simulation of wave propagation and agitation in a harbour area for an extreme wave event. The breaking waves (surface rollers) are shown in white. Output from the 2DH module including wave breaking

Wave breaking is implemented on basis of the surface roller concept for spilling breakers. The effect on the wave motion is modelled by introduction of additional convective terms, and the determination of the surface rollers is based on a geometric approach. The roller is considered a passive bulk of water isolated from the rest of the wave motion, while being transported with the wave celerity. The wave breaking is assumed initiated if the slope of the local water surface exceeds a certain angle, in which case the geometry of the surface roller is determined.

The incorporation of a moving shoreline is based on the following approach: the computation domain is extended artificially by replacing the solid beach by a permeable beach characterised by a very small porosity. Near the moving shoreline the water

surface will intersect with the seabed and continues into the porous beach. Hence the instantaneous position of the shoreline is simply determined by this intersection.

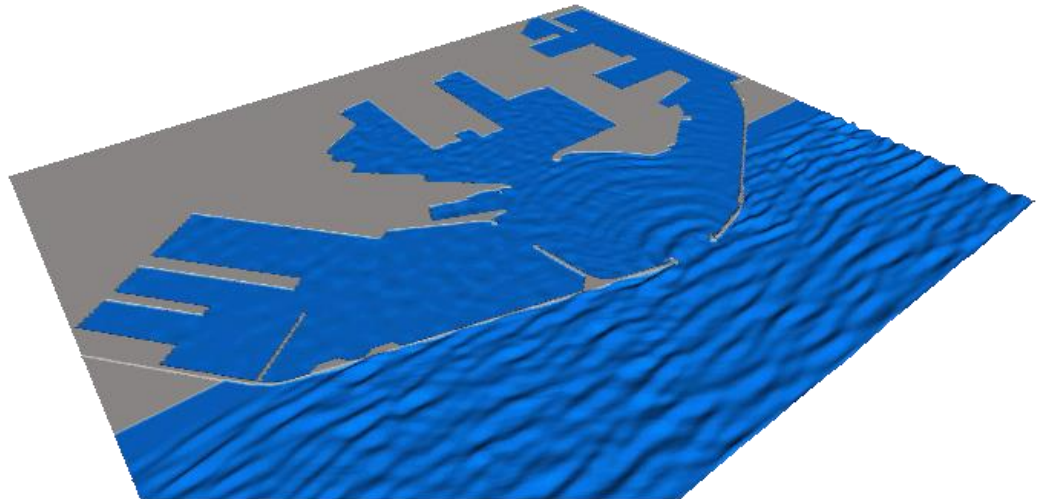

Figure 2.3 Example of deterministic output from the 2DH module. The figure shows the instantaneous surface elevation in Frederikshavn Harbour, Denmark. Output from 2DH module

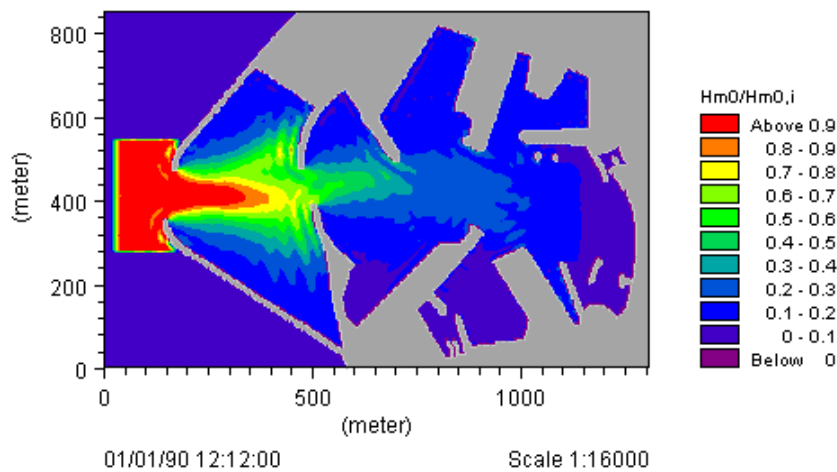

Figure 2.4 Example of wave disturbance output from the 2DH module of MIKE 21 BW. The figure shows the simulated wave disturbance coefficients in Rønne Harbour, Denmark

With inclusion of wave breaking and moving shoreline MIKE 21 BW is also an efficient tool for the study of many complicated coastal phenomena, e.g. wave induced-current patterns in areas with complex structures.



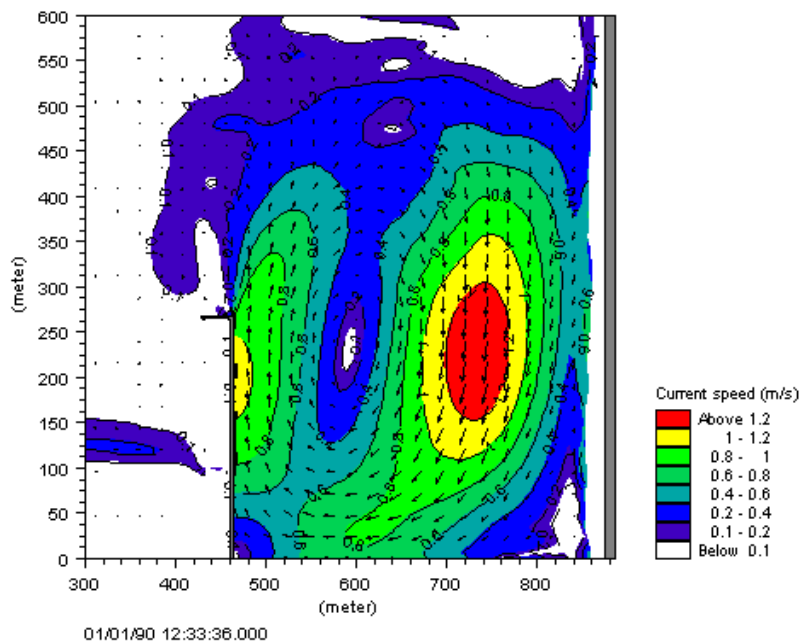
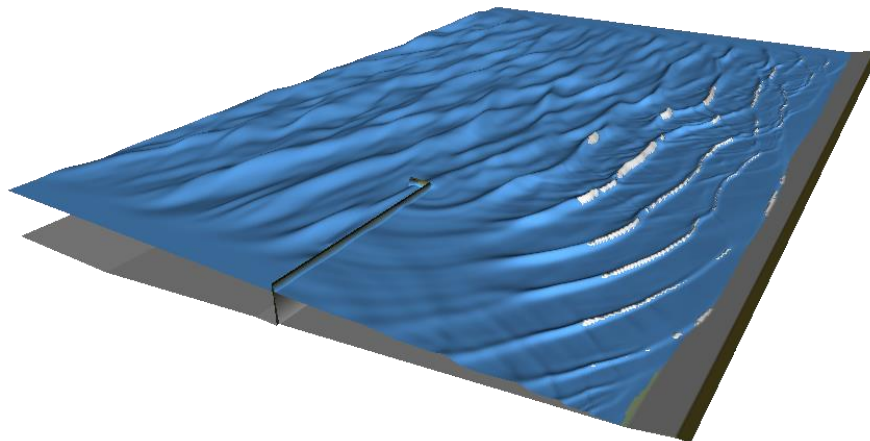

Figure 2.5 Wave transformation, wave breaking and run-up in vicinity of a detached breakwater parallel to the shoreline. The lower images show the associated circulation cell behind the breakwater. Output from the 2DH module

## 2.2 1DH Boussinesq Wave Module

The 1DH module solves the enhanced Boussinesq equations by a standard Galerkin finite element method with mixed interpolation for variables defined on a unstructured (or structured) grid. Surf zone dynamics and swash zone oscillations can be simulated for any coastal profile in this module.

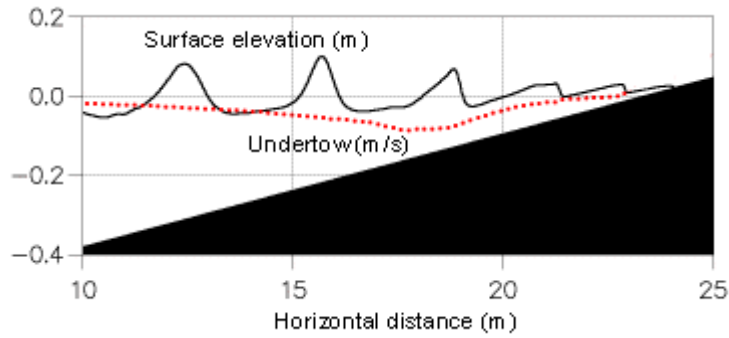

Figure 2.6 Example of output from the 1DH module of MIKE 21 BW. The panel shows the spatial variation of the surface elevation and the associated undertow in case of regular waves on a sloping beach

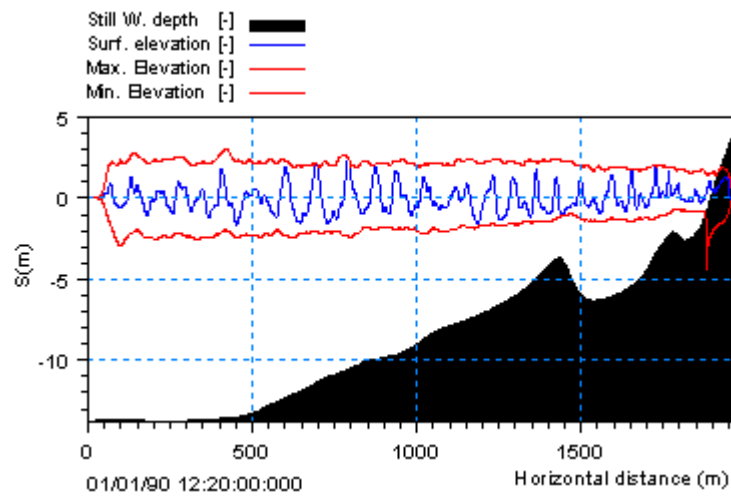

Figure 2.7 Example of deterministic output from the 1DH module of MIKE 21 BW. The figure shows the spatial variation of the surface elevation and the maximum and minimum elevation in case of irregular waves on a barred beach

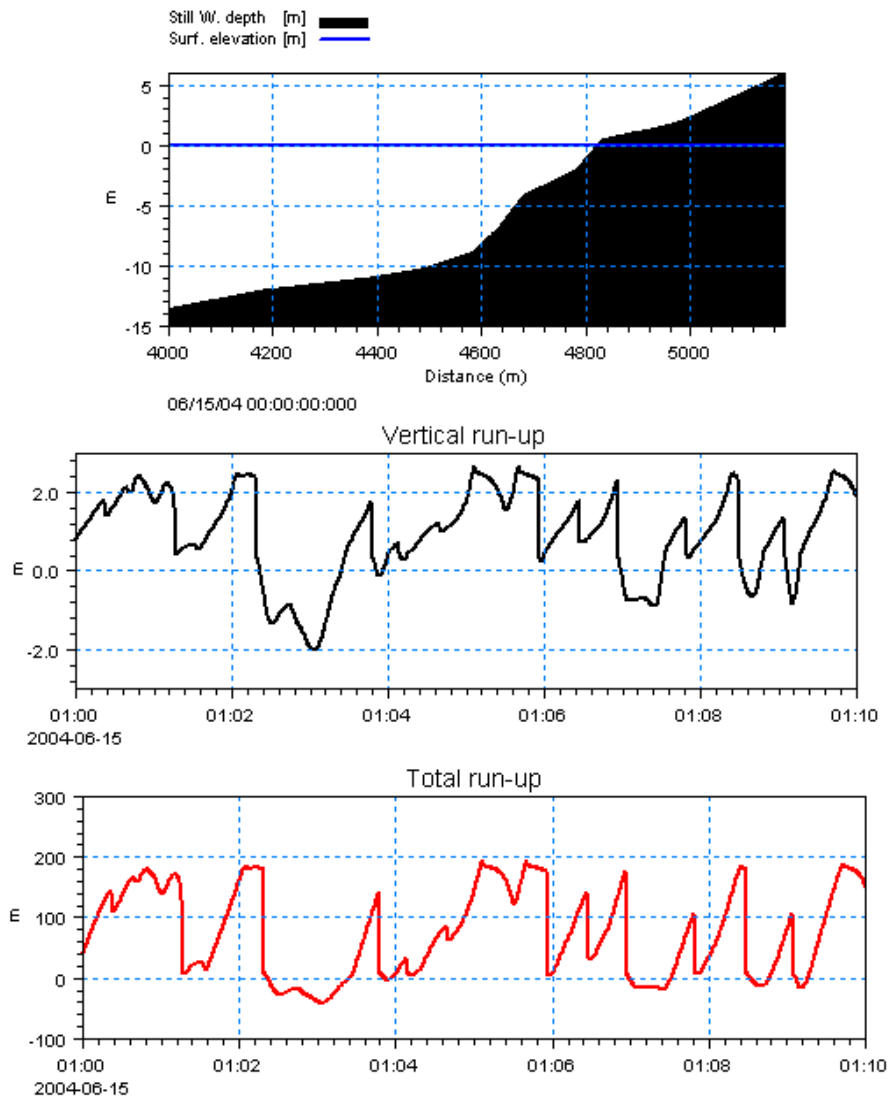

Figure 2.8 Example of moving shoreline output. Upper panel shows the coastal profile, middle the vertical run-up and lower panel the total run-up measured along the profile

### 3 Basic Equations

#### 3.1 Basic Equations for the 2DH Boussinesq Wave Module

The Boussinesq Wave Modules of MIKE 21 BW solve the enhanced Boussinesq equations expressed in one or two horizontal dimensions in terms of the free surface elevation,  $\xi$ , and the depth-integrated velocity-components,  $P$  and  $Q$ .

The Boussinesq equations read:

##### Continuity

$$n \frac{\partial \xi}{\partial t} + \frac{\partial P}{\partial x} + \frac{\partial Q}{\partial y} = 0$$

##### X-momentum

$$n \frac{\partial P}{\partial t} + \frac{\partial}{\partial x} \left( \frac{P^2}{h} \right) + \frac{\partial}{\partial y} \left( \frac{PQ}{h} \right) + \frac{\partial R_{xx}}{\partial x} + \frac{\partial R_{xy}}{\partial y} + F_x$$

$$n^2 gh \frac{\partial \xi}{\partial x} + n^2 P \left[ \alpha + \beta \frac{\sqrt{P^2 + Q^2}}{h} \right] + \frac{gP \sqrt{P^2 + Q^2}}{h^2 C^2} + n \Psi_1 = 0$$

##### Y-momentum

$$n \frac{\partial Q}{\partial t} + \frac{\partial}{\partial y} \left( \frac{Q^2}{h} \right) + \frac{\partial}{\partial x} \left( \frac{PQ}{h} \right) + \frac{\partial R_{yy}}{\partial y} + \frac{\partial R_{xy}}{\partial x} + F_y$$

$$n^2 gh \frac{\partial \xi}{\partial y} + n^2 Q \left[ \alpha + \beta \frac{\sqrt{P^2 + Q^2}}{h} \right] + \frac{gQ \sqrt{P^2 + Q^2}}{h^2 C^2} + n \Psi_2 = 0$$

where the Boussinesq dispersion terms  $\Psi_1$  and  $\Psi_2$  are defined by

$$\Psi_1 \equiv - \left( B + \frac{1}{3} \right) d^2 (P_{xxt} + Q_{xyt}) - nBg d^3 (\xi_{xxx} + \xi_{xyy})$$

$$- dd_x \left( \frac{1}{3} P_{xt} + \frac{1}{6} Q_{yt} + nBgd (2 \xi_{xx} + \xi_{yy}) \right)$$

$$- dd_y \left( \frac{1}{6} Q_{xt} + nBgd \xi_{xy} \right)$$

$$\begin{aligned} \Psi_2 \equiv & - \left( B + \frac{1}{3} \right) d^2 (Q_{yyt} + P_{xyt}) - nBg d^3 (\xi_{yyy} + \xi_{xxy}) \\ & - dd_y \left( \frac{1}{3} Q_{yt} + \frac{1}{6} P_{xt} + nBgd (2 \xi_{yy} + \xi_{xx}) \right) \\ & - dd_x \left( \frac{1}{6} P_{yt} + nBgd \xi_{xy} \right) \end{aligned}$$

Subscripts  $x$ ,  $y$  and  $t$  denote partial differentiation with respect to space and time, respectively.

### Symbol List

$P$	flux density in the x-direction, $m^3/s/m$
$Q$	flux density in the y-direction, $m^3/s/m$
$B$	Boussinesq dispersion factor
$F_x$	Horizontal stress term in x-direction
$F_y$	Horizontal stress term in y-direction
$x, y$	Cartesian co-ordinates, m
$t$	time, s
$h$	total water depth ( $=d+\xi$ ), m
$d$	still water depth, m
$g$	gravitational acceleration ( $= 9.81 \text{ m/s}^2$ )
$n$	porosity
$C$	Chezy resistance number, $m^{0.5}/s$
$\alpha$	resistance coefficient for laminar flow in porous media
$\beta$	resistance coefficient for turbulent flow in porous media
$\xi$	water surface level above datum, m

The horizontal stress terms are described using a gradient-stress relation, which reads

$$\begin{aligned} F_x &= - \left( \frac{\partial}{\partial x} \left( \nu_t \frac{\partial P}{\partial x} \right) + \frac{\partial}{\partial y} \left( \nu_t \left( \frac{\partial P}{\partial y} + \frac{\partial Q}{\partial x} \right) \right) \right) \\ F_y &= - \left( \frac{\partial}{\partial y} \left( \nu_t \frac{\partial Q}{\partial y} \right) + \frac{\partial}{\partial x} \left( \nu_t \left( \frac{\partial Q}{\partial x} + \frac{\partial P}{\partial y} \right) \right) \right) \end{aligned}$$

where  $\nu_t$  is the horizontal eddy viscosity.

The terms denoted  $R_{xx}$ ,  $R_{xy}$  and  $R_{yy}$  account for the excess momentum originating from the non-uniform velocity distribution due to the presence of the roller and they are defined by

$$R_{xx} = \frac{\delta}{1 - \delta/d} \left( c_x - \frac{P}{d} \right)^2$$

$$R_{xy} = \frac{\delta}{1 - \delta/d} \left( c_x - \frac{P}{d} \right) \left( c_y - \frac{Q}{d} \right)$$

$$R_{yy} = \frac{\delta}{1 - \delta/d} \left( c_y - \frac{Q}{d} \right)^2$$

Here  $\delta = \delta(t, x, y)$  is the thickness of the surface roller and  $c_x$  and  $c_y$  are the components of the roller celerity. A detailed description of these quantities is given in Madsen et al (1997a) p. 258ff and more recently in Sørensen et al (2004) p. 182ff.

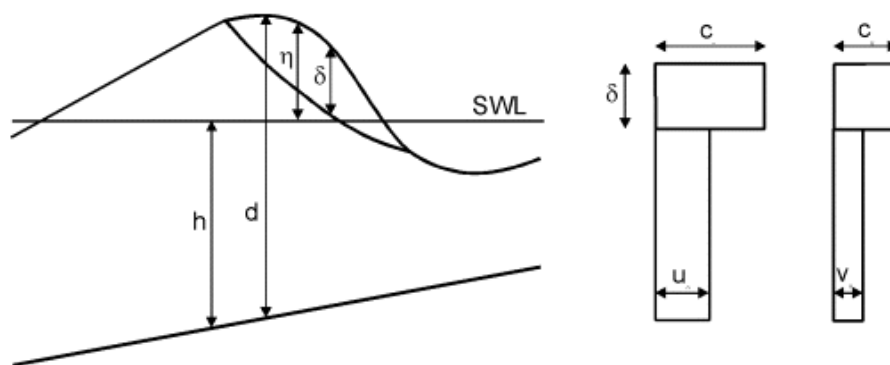

Figure 3.1 Surface roller concept: cross section of a breaking wave and assumed vertical profile of the horizontal particle velocity components

### On detection of roller celerity and direction

The roller celerity  $(c_x, c_y)$  is an essential parameter in surface roller model used in MIKE 21 BW. The formulation presented in Sørensen et al (2004) is used and is based on following approximation of the roller celerity:

$$(c_x, c_y) = (c \cdot \cos \theta, c \cdot \sin \theta)$$

$$c = f_v \sqrt{gh}$$

Using the roller celerity factor  $f_v = 1.0$ , we obtain the celerity determined by linear shallow water theory. This is often a rather good approximation just outside the surf zone, while  $f_v = 1.3$  (default in MIKE 21 BW), is more appropriate inside the surf zone (see discussion in Madsen et al, 1997a). The transition from  $f_v = 1.0$  to  $f_v = 1.3$  is modelled with an exponential time variation, see Sørensen et al (2004). The time constant applied is the same as the one for the variation of the breaking angle.

For the roller direction  $\theta$  two different types is available in MIKE 21 BW:

#### Type of roller celerity 1

The roller direction is determined interactively from the instantaneous wave field. The first procedure may sometime cause stability problems.

#### Type of roller celerity 3

The roller direction is set to a prescribed wave direction.

### 3.2 Basic Equations for the 1DH Boussinesq Wave Module

One of the main problems when solving Boussinesq type equations using finite element techniques is the presence of higher-order spatial derivatives. This problem is here handled by using an approach where the Boussinesq type equations are written in a lower order form by introducing a new auxiliary variable  $w$  and an auxiliary algebraic equation. The governing equations then have the following form:

$$n \frac{\partial \xi}{\partial t} + \frac{\partial P}{\partial x} = 0$$

$$n \frac{\partial P}{\partial t} + \frac{\partial}{\partial x} \left( \frac{P^2}{h} \right) + \frac{\partial R_{xx}}{\partial x} + n^2 gh \frac{\partial \xi}{\partial x} - n \left( B + \frac{1}{3} \right) d^2 \frac{\partial^3 P}{\partial x \partial x \partial t} +$$

$$- \frac{1}{3} d \frac{\partial d}{\partial x} \frac{\partial^2 P}{\partial x \partial t} - n^2 B g d^2 \frac{\partial w}{\partial x} + n^2 P \left[ \alpha + \beta \frac{|P|}{h} \right] + \frac{gP|P|}{h^2 C^2} = 0$$

$$w = \frac{\partial}{\partial x} \left( d \frac{\partial \xi}{\partial x} \right)$$

Note that these equations only contain terms with second order derivatives with respect to the spatial co-ordinates. Recasting these equations into a weak form using the standard Galerkin finite element method and applying the divergence theorem to the dispersive Boussinesq type terms, the equations can be written in a form which only requires the interpolation functions to be continuous, see Sørensen et al (2004).

## 4 Numerical Implementation

### 4.1 2DH Boussinesq Wave Module

The numerical method used is based on the same numerical scheme as in MIKE 21 Flow Model, which was introduced by Abbott et al (1973) and extended to short-wave modelling by Abbott et al (1978)<sup>4</sup>. Since then, this robust scheme has been under constant development, see Madsen et al (1991) and Madsen and Sørensen (1992).

The differential equations are spatially discretized on a rectangular, staggered grid as illustrated in Figure 4.1. Scalar quantities such as water surface elevation are defined in the grid nodes, whereas flux components are defined halfway between adjacent grid nodes in the respective directions. The finite-difference approximation of the spatial derivatives is a straightforward mid-centring, except for the convective terms, which are described in detail in Madsen and Sørensen (1992).

The integration in time is performed using a time-centred implicit scheme.

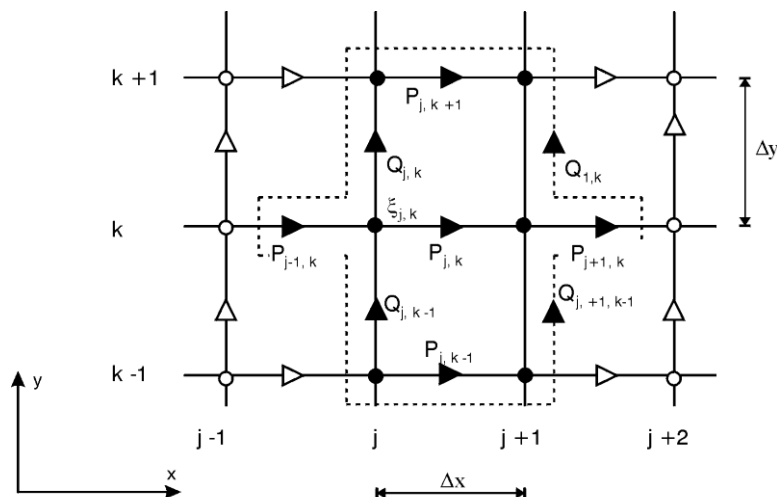

Figure 4.1 Staggered grid in x-y-space.

The applied algorithm is a non-iterative Alternating Direction Implicit (ADI) algorithm, using a ‘fractional step’ technique and ‘side-feeding’ (semi-linearisation of non-linear terms). The resulting tri-diagonal systems of equations are solved by the well know Double Sweep Algorithm.

The reader is referred to Chapter 6, where an in-depth description of the numerical formulation used in the 2DH wave module is given in various papers.

<sup>4</sup> Abbott, M B, Petersen, H M & Skovgaard, O (1978): On the Numerical Modelling of Short Waves in Shallow Water. J Hydr Res., 16, 3, 173-203. This paper is included in the DHI Software Installation



## 4.2 1DH Boussinesq Wave Module

Finite element solutions of the Boussinesq equations in primitive form can exhibit severe spurious modes especially when equal-order interpolation functions are applied for the fluxes and the surface elevation. To get stable and oscillation free solutions, mixed interpolation is used in the present version of the module. Elements with quadratic fluxes and linear surface elevation and auxiliary variable are applied.

The integration in time is performed using either an explicit three step Taylor-Galerkin scheme (default) or a predictor-corrector method (a 4th-order Adams-Bashforth-Moulton method, optional).

To obtain the auxiliary variable and the derivatives with respect to time of the fluxes and surface elevation, three set of linear equations have to be solved. For small problems, these systems can be solved using Gaussian elimination with sparse technique (default). However, for large systems more cost-efficient methods must be applied such as a Krylov subspace iterative method (e.g. GMRES) combined with an efficient preconditioner (e.g. an incomplete LU factorisation). Both methods have been implemented in the present version.

A detailed description of the numerical implementation can be found in Sørensen et al (2004).

In the present version supports both structured and unstructured meshes. An unstructured mesh gives the maximum degree of flexibility.

## 5 Verification

### 5.1 2DH Boussinesq Wave Module

The 2DH module has been verified against analytical and experimental data in Madsen et al (1991) and Madsen and Sørensen (1992).

Simulated results have also been compared to physical model results and field measurements in cases of complex harbour geometries. Reference is made to the reference section in the User Guide, which includes a number of papers on applications and practical aspects. Some of the references include comparisons with experimental and field measurements.

MIKE 21 BW has also been used to model seiching in an exposed harbour<sup>5</sup>, see Figure 5.1. Also physical model results were available. Both models showed occurrence of substantial low-frequency energy caused by non-linear interaction of the primary short wind-waves. The seiching was concentrated around frequencies corresponding to wave periods of 50-80s (natural fundamental mode) and 6-7 minutes (Helmholtz resonance mode). Comparison of results from the numerical and physical model was found to be excellent. This supports the use of MIKE 21 BW in determination of short as well as long wave disturbance in ports and harbours.

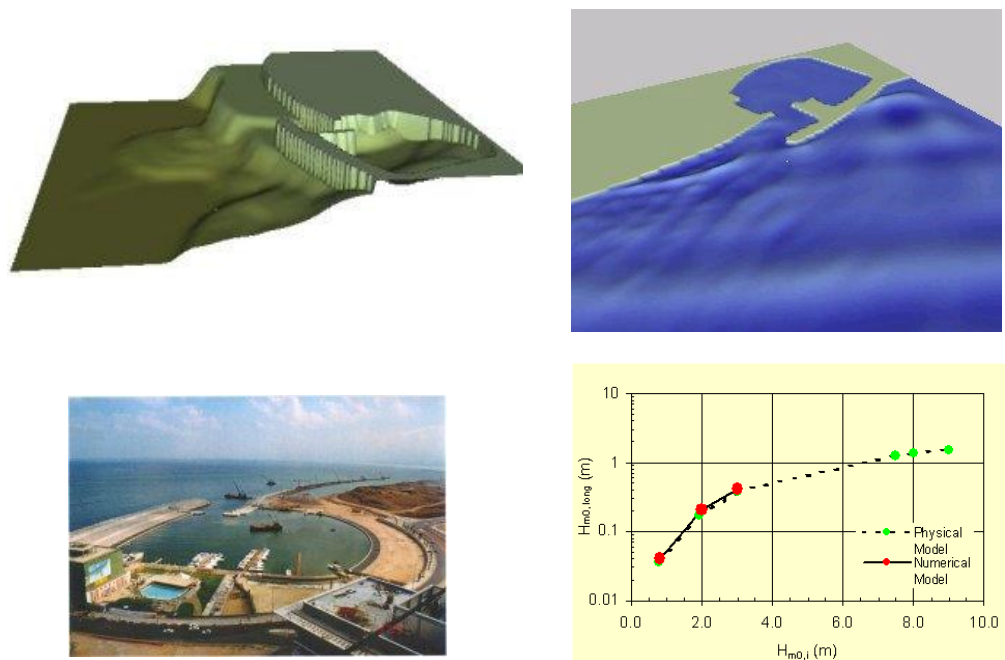

Figure 5.1 Verification of MIKE 21 BW 2DH module in case of seiching

<sup>5</sup> The comparison is presented in Kofoed-Hansen, H. Sloth P., Sørensen, O.R and Fuchs, J., 2001. Combined numerical and physical modelling of seiching in exposed new marina. In Proc. 27<sup>th</sup> International Conference of Coastal Engineering, 3600-3614.

## 5.2 1DH Boussinesq Wave Module

In order to verify the accuracy of the numerical approach, the results of the new model have been compared to both experimental data and to results obtained by using a Boussinesq model based on the finite difference method (Madsen et al, 1997a,b). The results are presented in Sørensen and Sørensen (2001)<sup>6</sup>.

In case of shoaling and breaking waves on a gently sloping beach Figure 5.2 shows the spatial variation of the crest and trough elevation as well as of the mean water level computed by the two numerical models. The agreement between the two numerical models is very good. Only in the inner breaking zone, a very small discrepancy can be seen, which is due to differences in the treatment of the convective terms. By comparison with the experimental data, it is clearly seen that the pronounced shoaling just before breaking is underestimated in both models, while the position of the breakpoint is well predicted.

The enhanced Boussinesq type equations provide very good linear shoaling characteristics for  $kh$  (wave number times depth) up to 3, but the transfer of energy to super-harmonics is generally underestimated.

A combination of these two effects results in an underestimation of the non-linear shoaling near the breaking point.

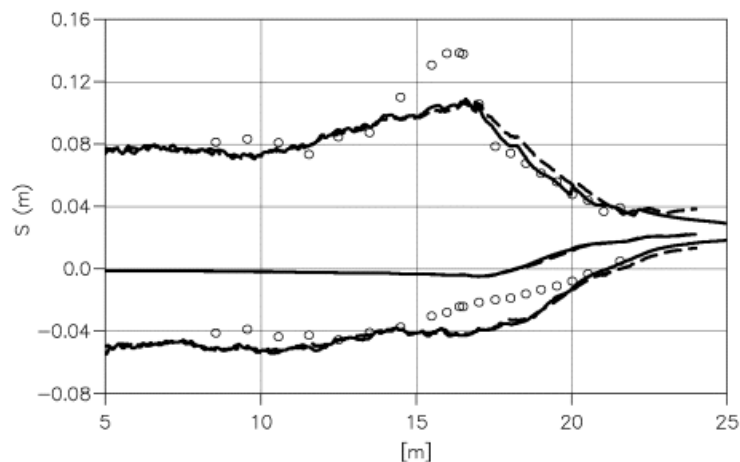

Figure 5.2 Spatial variation of the wave crest elevation, wave trough elevation and mean water level. (—) MIKE 21 BW 1DH; (- - -) Boussinesq model based on finite difference); (o) Experimental data by Ting and Kirby (1994). Figure taken from Sørensen and Sørensen (2001)

Figure 5.3 shows a comparison between numerical model results and experimental data in case of wave transformation on a coastal profile including a sill. The agreement between the model results and the experimental data is very good.

<sup>6</sup> Sørensen, O.R. and Sørensen, L.S. 2001. Boussinesq type modelling using unstructured finite element technique. In Proc. 27<sup>th</sup> Coastal Eng. Conf. 190-202

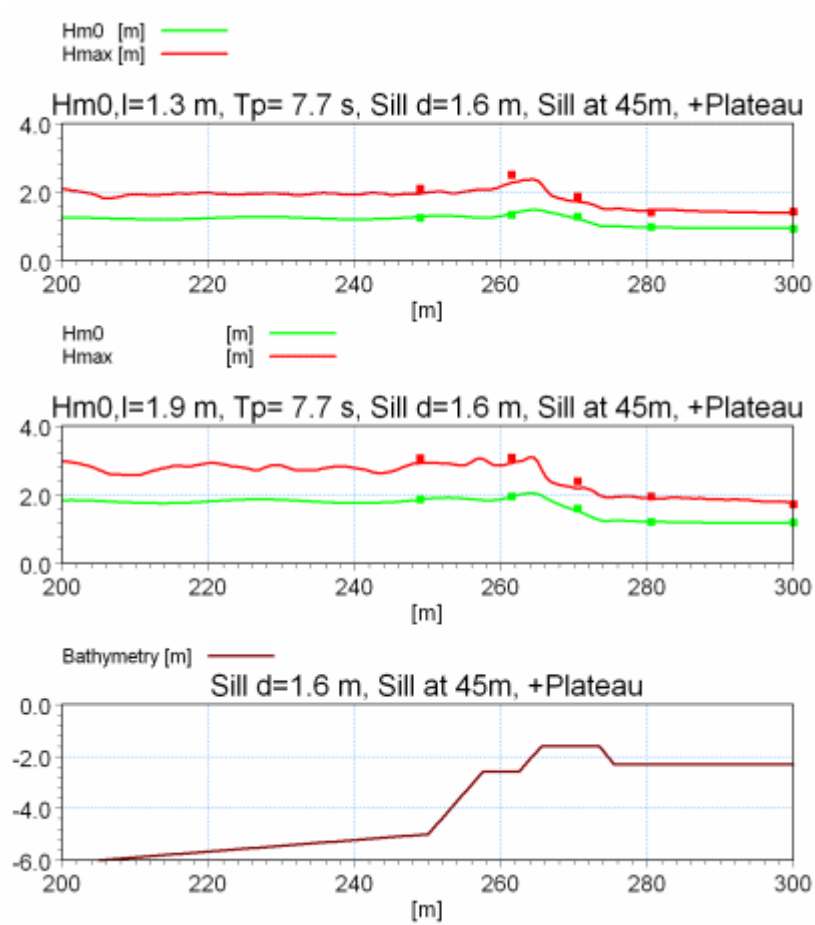

Figure 5.3 Spatial variation of the significant and maximum wave height on a coastal profile. Comparison between 1DH results and physical model data (circles and squares)

## 6 References

The present chapter aims at giving an in-depth description of physical, mathematical and numerical background related to Boussinesq wave modelling by inclusion of papers listed below. The papers are in the form of ready-to-read-and-print Adobe Acrobat Document (.pdf file).

- /1/ Sørensen, O.R., Schäffer, H.A. and Sørensen. L.S. (2004). "Boussinesq-type modelling using an unstructured finite element technique". *Coastal Eng.*, **50**, 181-198.
- /2/ Sørensen, O.R, Schäffer, H.A. and Madsen P.A. (1998). Surf zone dynamics simulated by a Boussinesq type model. Part III: Wave-induced horizontal nearshore circulations. *Coastal Eng.*, **33**, 155-176.
- /3/ Madsen, P.A., Sørensen, O.R. and Schäffer, H.A., 1997a. Surf zone dynamics simulated by a Boussinesq type model. Part I: Model description and cross-shore motion of regular waves. *Coastal Eng.*, **32**, 255-288.
- /4/ Madsen, P.A., Sørensen, O.R. and Schäffer, H.A., 1997b. Surf zone dynamics simulated by a Boussinesq type model. Part II: Surf beat and swash zone oscillations for wave groups and irregular waves. *Coastal Eng.*, **32**, 289-320.
- /5/ Madsen, P A. and Sørensen, O. R., 1992. A New Form of the Boussinesq Equations with Improved Linear Dispersion Characteristics, Part 2: A Slowly-varying Bathymetry. *Coastal Eng.*, **18**, 183-204.
- /6/ Madsen, P.A., Murray, R. and Sørensen, O. R., 1991. A New Form of the Boussinesq Equations with Improved Linear Dispersion Characteristics (Part 1). *Coastal Eng.*, **15**, 371-388.
- /7/ Madsen, P.A., 1983. Wave Reflection from a Vertical Permeable Wave Absorber. *Coastal Eng.*, **7**, 381-396.
- /8/ Abbott, M. B., Petersen, H. M. and Skovgaard, O., 1978. On the Numerical Modelling of Short Waves in Shallow Water. *J Hydr Res.*, **16**, 173-204.