

MIKE 3 Flow Model FM

Hydrodynamic Module

User Guide





PLEASE NOTE

COPYRIGHT

This document refers to proprietary computer software which is protected by copyright. All rights are reserved. Copying or other reproduction of this manual or the related programs is prohibited without prior written consent of DHI A/S (hereinafter referred to as "DHI"). For details please refer to your 'DHI Software Licence Agreement'.

LIMITED LIABILITY

The liability of DHI is limited as specified in your DHI Software Licence Agreement:

In no event shall DHI or its representatives (agents and suppliers) be liable for any damages whatsoever including, without limitation, special, indirect, incidental or consequential damages or damages for loss of business profits or savings, business interruption, loss of business information or other pecuniary loss arising in connection with the Agreement, e.g. out of Licensee's use of or the inability to use the Software, even if DHI has been advised of the possibility of such damages.

This limitation shall apply to claims of personal injury to the extent permitted by law. Some jurisdictions do not allow the exclusion or limitation of liability for consequential, special, indirect, incidental damages and, accordingly, some portions of these limitations may not apply.

Notwithstanding the above, DHI's total liability (whether in contract, tort, including negligence, or otherwise) under or in connection with the Agreement shall in aggregate during the term not exceed the lesser of EUR 10.000 or the fees paid by Licensee under the Agreement during the 12 months' period previous to the event giving rise to a claim.

Licensee acknowledge that the liability limitations and exclusions set out in the Agreement reflect the allocation of risk negotiated and agreed by the parties and that DHI would not enter into the Agreement without these limitations and exclusions on its liability. These limitations and exclusions will apply notwithstanding any failure of essential purpose of any limited remedy.





CONTENTS



1	About This Guide	9
1.1	Purpose	9
1.2	Assumed User Background	9
1.3	General Editor Layout	9
1.3.1	Navigation tree	9
1.3.2	Editor window	9
1.3.3	Validation window	10
1.4	Online Help	10
2	Introduction	11
2.1	Short Description	11
2.2	Application Areas	12
3	Getting Started	13
4	Examples	15
4.1	General	15
4.2	Wind Driven Circulation in an Enclosed Water Body	15
4.2.1	Purpose of the example	15
4.2.2	Defining the problem	15
4.2.3	Analytical solution	16
4.2.4	Presenting and evaluating the results	17
4.2.5	List of data and specification files	18
4.3	and material zones illustrated by the hyetograph in illustrated in Flow Modelling in the Sound, Denmark	19
4.3.1	Purpose of the example	19
5	BASIC PARAMETERS	21
5.1	Domain	21
5.1.1	Mesh and bathymetry	22
5.1.2	Domain specification	24
5.1.3	Vertical mesh	25
5.1.4	Boundary names	30
5.1.5	Material and infrastructure	30
5.2	Time	33
5.2.1	Remarks and hints	33
5.3	Module Selection	34
6	HYDRODYNAMIC MODULE	35
6.1	Basic Equations	35
6.2	Solution Technique	35
6.2.1	CFL number	36
6.2.2	Remarks and hints	37
6.3	Depth Correction	38
6.3.1	General description	38
6.4	Flood and Dry	39
6.4.1	General description	39
6.4.2	Recommended values	40
6.4.3	Remarks and hints	40



6.5	Density	40
6.5.1	Remarks and hints	41
6.6	Eddy Viscosity	41
6.6.1	Horizontal eddy viscosity	41
6.6.2	Vertical Eddy Viscosity	42
6.6.3	General description	43
6.6.4	Recommended values	44
6.6.5	Remarks and hints	45
6.7	Bed Resistance	45
6.7.1	General description	46
6.7.2	Recommended values	47
6.7.3	Remarks and hints	47
6.8	Coriolis Forcing	48
6.9	Wind Forcing	48
6.9.1	Wind friction	49
6.9.2	General description	49
6.9.3	Remarks and hints	50
6.10	Ice Coverage	50
6.11	Tidal Potential	52
6.11.1	Remarks and hints	53
6.12	Precipitation-Evaporation	53
6.13	Infiltration	54
6.13.1	Infiltration specification	54
6.13.2	General description	57
6.14	Wave Radiation	58
6.14.1	Recommendations	58
6.14.2	Remarks and hints	58
6.15	Sources	59
6.15.1	Source specification	59
6.15.2	Output	62
6.15.3	General description	62
6.16	Infrastructure	64
6.16.1	General description	65
6.17	Structures	65
6.17.1	Weirs	66
6.17.2	Culverts	70
6.17.3	Dikes	77
6.17.4	Gates	82
6.17.5	Piers	85
6.17.6	Turbines	88
6.17.7	Composite structures	91
6.17.8	Remarks and hints	93
6.18	Waves	94
6.19	Initial Conditions	97
6.20	Boundary Conditions	98
6.20.1	Boundary specification	99



6.20.2	General description	105
6.21	Temperature/Salinity Module	107
6.22	Turbulence Module	108
6.23	Decoupling	108
6.23.1	Decoupling output files	108
6.23.2	Remarks and hints	109
6.24	Outputs	109
6.24.1	Geographical view	109
6.24.2	Output specification	109
6.24.3	Output items	117
7	TEMPERATURE/SALINITY MODULE	121
7.1	Equation	121
7.2	Solution Technique	121
7.2.1	Remarks and hints	121
7.3	Dispersion	122
7.3.1	Dispersion specification	122
7.3.2	Recommended values	123
7.4	Heat Exchange	124
7.4.1	Specification	124
7.5	Precipitation-Evaporation	127
7.6	Infiltration	128
7.7	Sources	129
7.7.1	Source Specification	129
7.7.2	Remarks and hints	130
7.8	Initial Conditions	130
7.9	Boundary Conditions	131
7.9.1	Boundary specification	131
8	TURBULENCE MODULE	133
8.1	Equation	133
8.2	Solution Technique	134
8.2.1	Remarks and hints	134
8.3	Dispersion	135
8.4	Initial Conditions	135
8.4.1	Recommended values	136
8.5	Boundary Conditions	136
8.5.1	Boundary Specification	136
8.5.2	Recommended values	138
9	LIST OF REFERENCES	139
	Index	143



1 About This Guide

1.1 Purpose

The main purpose of this User Guide is to enable you to use, MIKE 3 Flow Model FM, Hydrodynamic Module, for applications of hydraulic phenomena in lakes, estuaries, bays, coastal areas and seas. The User Guide is complemented by the Online Help.

1.2 Assumed User Background

Although the hydrodynamic module has been designed carefully with emphasis on a logical and user-friendly interface, and although the User Guide and Online Help contains modelling procedures and a large amount of reference material, common sense is always needed in any practical application.

In this case, “common sense” means a background in coastal hydraulics and oceanography, which is sufficient for you to be able to check whether the results are reasonable or not. This User Guide is not intended as a substitute for a basic knowledge of the area in which you are working: Mathematical modelling of hydraulic phenomena.

It is assumed that you are familiar with the basic elements of MIKE Zero: File types and file editors, the Plot Composer, the MIKE Zero Toolbox, the Data Viewer and the Mesh Generator. The documentation for these can be found from the MIKE Zero Documentation Index.

1.3 General Editor Layout

The MIKE 3 Flow Model FM setup editor consists of three separate panes.

1.3.1 Navigation tree

To the left is a navigation tree, that shows the structure of the model setup file, and is used to navigate through the separate sections of the file. By selecting an item in this tree, the corresponding editor is shown in the central pane of the setup editor.

1.3.2 Editor window

The editor for the selected section is shown in the central pane. The content of this editor is specific for the selected section, and might contain several property pages.

For sections containing spatial data - e.g. sources, boundaries and output - a geographic view showing the location of the relevant items will be available.



The current navigation mode is selected in the bottom of this view, it can be zoomed in, zoomed out or recentered. A context menu is available from which the user can select to show the bathymetry or the mesh and to show the legend. From this context menu it is also possible to navigate to the previous and next zoom extent and to zoom to full extent. If the context menu is opened on an item - e.g. a source - it is also possible to jump to this item's editor.

Further options may be available in the context menu depending on the section being edited.

1.3.3 Validation window

The bottom pane of the editor shows possible validation errors, and is dynamically updated to reflect the current status of the setup specifications.

By double-clicking on an error in this window, the editor in which this error occurs will be selected.

1.4 Online Help

The Online Help can be activated in several ways, depending on the user's requirement:

- **F1-key seeking help on a specific activated dialog:**
To access the help associated with a specific dialog page, press the F1-key on the keyboard after opening the editor and activating the specific property page.
- **Open the On-line Help system for browsing manually after a specific help page:**
Open the On-line Help system by selecting "Help Topics" in the main menu bar.



2 Introduction

MIKE 3 Flow Model FM is a modelling system based on a flexible mesh approach. The modelling system has been developed for applications within oceanographic, coastal and estuarine environments.



Figure 2.1 Odense Estuary, Denmark. Computation mesh used in MIKE 3 Flow Model FM for studying hydrodynamics and ecosystem dynamics.

MIKE 3 Flow Model FM is composed of following modules:

- Hydrodynamic Module
- Transport Module
- MIKE ECO Lab/Oil Spill Module
- Particle Tracking Module
- Mud Transport Module
- Sand Transport Module

The Hydrodynamic Module is the basic computational component of the entire MIKE 3 Flow Model FM modelling system providing the hydrodynamic basis for the Transport Module, MIKE ECO Lab/Oil Spill Module, Mud Transport Module, Particle Tracking Module and Sand Transport Module.

2.1 Short Description

The Hydrodynamic Module is based on the numerical solution of the three-dimensional incompressible Reynolds averaged Navier-Stokes equations invoking the assumptions of Boussinesq. Both the full 3D Navier-Stokes equations and the 3D shallow water equations can be applied. The latter



invokes the hydrostatic pressure assumption. Thus, the model consists of continuity, momentum, temperature, salinity and density equations and is closed by a turbulent closure scheme. In the horizontal domain both Cartesian and spherical coordinates can be used. The free surface is taken into account using a sigma-coordinate transformation approach.

The spatial discretization of the governing equations in conserved form is performed using a cell-centered finite volume method. The spatial domain is discretized by subdivision of the continuum into non-overlapping element/cells. In the horizontal plane an unstructured grid is used while in the vertical domain a structured discretization is used. The elements can be prisms or bricks whose horizontal faces are triangles and quadrilateral elements, respectively.

For the time integration a semi-implicit approach is used where the horizontal terms are treated explicitly and the vertical terms are treated implicitly.

The interface convective fluxes are calculated using an approximate Riemann solver. This shock-capturing scheme enables robust and stable simulation of flows involving shocks or discontinuities such as bores and hydraulic jumps.

2.2 Application Areas

The application areas generally involve problems where flow and transport phenomena are important with emphasis on oceanographic, coastal and marine applications, where the flexibility inherited in the unstructured meshes can be utilized.

3 Getting Started

A comprehensive step-by-step training guide covering the MIKE 3 Flow Model FM is provided with the DHI Software installation. The example is related to the construction of a fixed link across Øresund, the sound between Denmark and Sweden, where one of the main constraints were that the environment of the Baltic Sea should remained unaffected by the link. The training guide (PDF-format) can be accessed from the MIKE 3 Documentation index:

MIKE 21 & MIKE 3 Flow Model FM, Hydrodynamic Module, Step-by-Step Training Guide

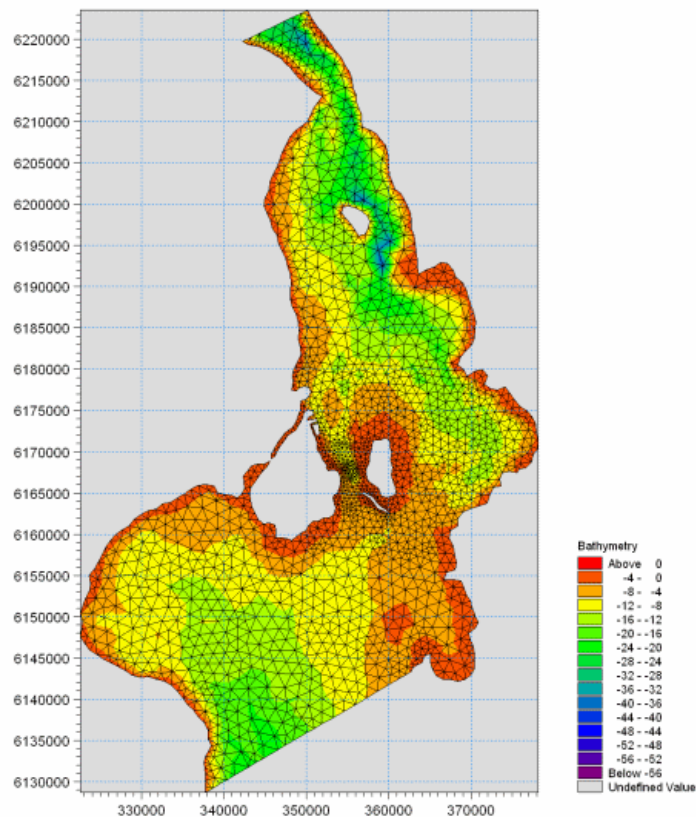

Figure 3.1 Computation mesh used in the MIKE 3 Flow Model FM step-by-step training guide

In addition to the Øresund training guide we have included an additional MIKE 3 Flow Model FM step-by-step-guide with focus on ecological modeling (by use of the ECO Lab Module) for Odense Estuary, Denmark. It is assumed that the reader is familiar with setting up a hydrodynamic model in



MIKE 3 Flow Model FM. The training guide (PDF-format) can be accessed from the MIKE 3 Documentation index:

MIKE 3 Flow Model FM, ECO Lab Module, Step-by-Step Training Guide



4 Examples

4.1 General

One of the best ways of learning how to use a modelling system such as MIKE 3 Flow Model FM is through practice. Therefore a number of examples are included which you can go through yourself and which you can modify, if you like, in order to see what happens if one or other parameter is changed.

The specification files for the examples are included with the installation of MIKE Zero. A directory is provided for each example. The directory names are as follows:

- Wind Set-up in a Rectangular Lake:
Examples\MIKE_3\FlowModel_FM\HD\Basin
- The Sound (Øresund), Denmark. From scratch to calibrated model:
Examples\MIKE_3\FlowModel_FM\HD\Oresund

4.2 Wind Driven Circulation in an Enclosed Water Body

4.2.1 Purpose of the example

This example has been chosen as a fairly simple one, so that it is possible to check the results analytically. For this example the shallow water equations are used.

The problem is to determine the wind set-up in a closed basin. The test conditions are:

- The basin is rectangular in shape with a length of 1250 m in the east/west direction, and a length of 100 m in the north/south direction. The basin has a uniform depth of 10 m.
- A westerly wind of 35 m/s is blowing.

4.2.2 Defining the problem

The main conditions defining the problem are:

- An unstructured mesh with 174 elements and 122 nodes is used. The mesh is shown in Figure 4.1. In the vertical domain 10 layers are used.
- The *time step* is selected as 1 second and the duration time of the simulation is 80 minutes (4800 time steps).
- The *horizontal eddy viscosity* type has been chosen to the Smagorinsky formulation and a constant value of 0.28.



- The *vertical eddy viscosity* type has been chosen to the k-ε formulation.
- The *bed resistance* type has been chosen to roughness height and a constant value of 0.05m is applied.
- The wind is specified as constant with wind speed 35 m/s and wind direction 270 °N.
- The length of *soft start interval* (warm-up period) for the wind has been chosen to 20 minutes (1200 seconds) to avoid chock effects.
- A constant *wind friction coefficient* of 0.002425 is applied.

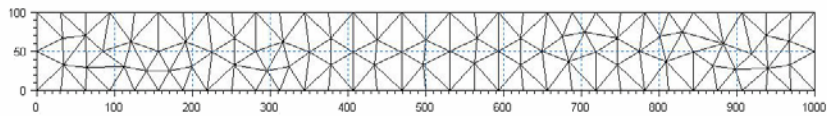

Figure 4.1 Mesh for the enclosed basin

4.2.3 Analytical solution

A steady wind blowing over an enclosed water body generates a circulation in the water body and a set-up of the water surface. Assuming a static equilibrium between the wind set-up and the wind shear stress, the wind set-up can be determined from a depth integrated balance of forces.

The wind induced surface stress, $\overline{\tau_w}$, is given by the following empirical relation

$$\overline{\tau_w} = \rho_a c_d |u_w| \overline{u_v} \quad (4.1)$$

where ρ_a is the density of air, c_d is the empirical drag coefficient of air, and $\overline{u_w} = (u_w, v_w)$ is the wind speed 10 m above the ground.

Assuming that the water depths are large compared to the wind set-up, the force balance can then be written as

$$g \rho_0 d \frac{\Delta h}{L} = \tau_w \quad (4.2)$$

where Δh is the wind set-up, d is the still water depth, L is length of lake, ρ_0 is density of water and g is the gravitational acceleration. Rearranging yields an expression for the set-up

$$\Delta h = \frac{\tau_w}{g \rho_0} \frac{L}{d} \quad (4.3)$$



The set-up will be associated with a wind driven circulation. A drift current with speed in the order of 4% of the wind speed is induced in the upper part of the water column and a compensating return current with speed approximately 1/3 of the drift current, is induced in the lower parts. The velocity profile, some distance from the basin ends, will approximately follow a logarithmic profile. The velocity profile can be given from a velocity defect law as

$$\frac{u}{U_{\tau}} = \frac{1}{\kappa} \left(1 + \ln \left(\frac{-z}{h} \right) \right) \quad (4.4)$$

where u is the velocity in level z , h is water depth, $\kappa = 0.41$ is the von Karman constant and $U_{\tau} = \max(U_{\tau s}, U_{\tau b})$. $U_{\tau s} = \sqrt{\tau_w / \rho_0}$ and $U_{\tau b} = \sqrt{\tau_b / \rho_0}$ are the friction velocities associated with the surface and bottom stresses.

The eddy viscosity derived from the log-law is calculated by

$$v_t = U_{\tau} \kappa h \frac{-z}{h} \left(1 - \left(\frac{-z}{h} \right) \right) \quad (4.5)$$

4.2.4 Presenting and evaluating the results

Time series for point data can be specified directly as model output or extracted from 2D and 3D data files using the MIKE Zero Data Viewer. Time series for line data can also be specified directly as model output.

Figure 4.2 shows the time series of surface elevation at two points at the west and east end of the basin.

Entering the parameters into eq. (4.3) and assuming that the model has reached a steady solution results in a set-up of 0.039 m. This corresponds closely to the final result shown in Figure 4.2.

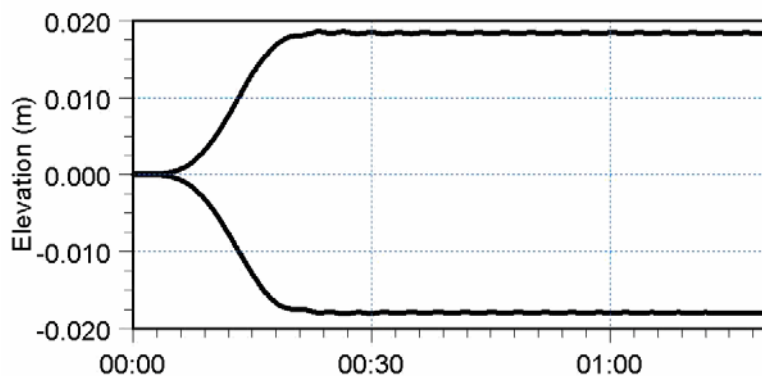

Figure 4.2 Surface elevation. Analytical estimate shows a set-up of 0.037 m.

Figure 4.3 shows velocity profile and the eddy viscosity profile at a vertical line in the centre of the basin (from (500, 50, -9.5) to (500, 50, -0.5)). For comparison is shown the analytical solution using the log law.

Note, that the solution given by Eq. (4.1) and Eq. (4.2) is only an approximation to the solution obtained using the $k-\epsilon$ model.

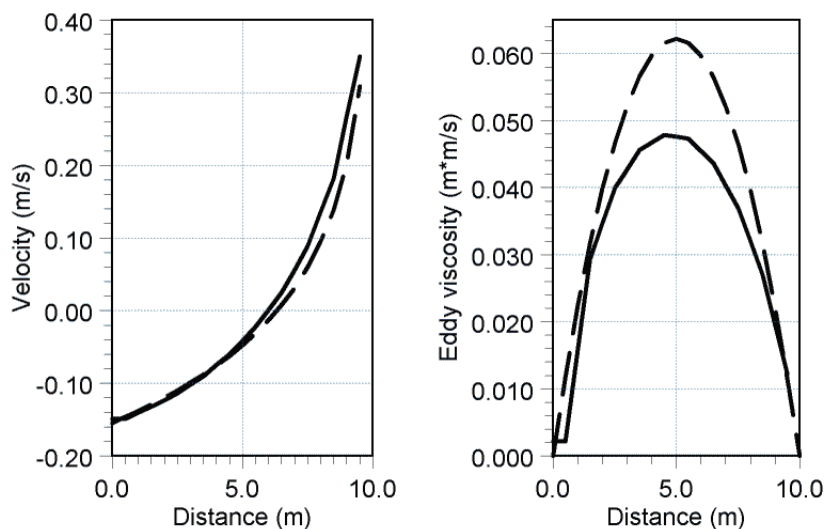

Figure 4.3 Vertical velocity profile and eddy-viscosity profile.
Full line: calculated values,
Stippled line: velocity profile eq. (4.4) and eddy viscosity profile eq. (4.5)

4.2.5 List of data and specification files

The following data files (included in the \HD\Basin folder) are supplied with MIKE 3 Flow Model FM:



File name: Basin.mesh

Description: Mesh-file including the mesh and bathymetry

File name: Basin.m3fm

Description: MIKE 3 Flow Model FM specification file

4.3 and material zones illustrated by the hyetograph in illustrated in **Flow Modelling in the Sound, Denmark**

4.3.1 Purpose of the example

The objectives of this example is to setup a MIKE 3 Flow Model FM for Øresund, Denmark, from scratch and to calibrate the model to a satisfactory level.

An easy to follow Step-by-step guide is provided in the default installation folder: Manuals\MIKE_3\FlowModel_FM\HD





5 BASIC PARAMETERS

5.1 Domain

The MIKE 3 Flow Model FM is based on flexible mesh approach. Providing MIKE 3 Flow Model FM with a suitable mesh is essential for obtaining reliable results from your model. Setting up the mesh includes selection of the appropriate area to be modelled, adequate resolution of the bathymetry, wave, wind and flow fields under consideration and definition of codes for open and closed boundaries. Furthermore, the resolution in the geographical space must also be selected with respect to stability considerations.

A layered mesh is used: In the horizontal domain an unstructured mesh is used while in the vertical domain a structured mesh is used (see Figure 5.1). The vertical mesh is based on either sigma-coordinates or combined sigma/z-level coordinates. For the hybrid sigma/z-level mesh sigma coordinates are used from the free surface to a specified depth and z-level coordinates are used below. The different types of vertical mesh are illustrated in Figure 5.2. The elements in the sigma domain and the z-level domain can be prisms or bricks (hexahedrals) whose horizontal faces are triangles and quadrilateral elements, respectively. The elements are perfectly vertical and all layers have identical topology.

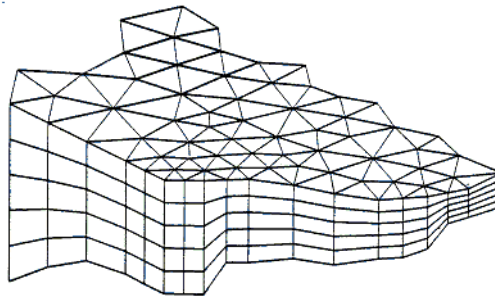

Figure 5.1 3D mesh using sigma coordinates

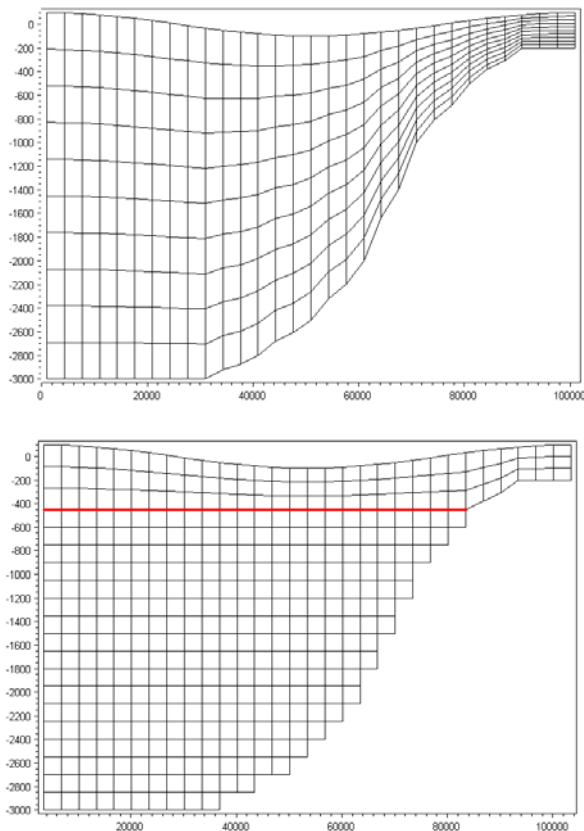

Figure 5.2 Illustrations of the different vertical grids. Upper: sigma mesh, Lower: combined sigma/z-level mesh with simple bathymetry adjustment. The red line shows the interface between the z-level domain and the sigma-level domain.

5.1.1 Mesh and bathymetry

The mesh and bathymetry can be specified either using a mesh file or a bathymetry data file.

Mesh file

You generate your mesh file in the MIKE Zero Mesh Generator, which is a tool for the generation and handling of unstructured meshes, including the definition and editing of boundaries.

The mesh file is an ASCII file including information of the map projection and of the geographical position and bathymetry (Bed elevation) for each node point in the mesh. The file also includes information of the node-connectivity in the mesh.



Bathymetry data file

You generate your bathymetry data file in the MIKE Zero Bathymetry Editor, which is a tool for the generation of structured meshes. An example with a step-by-step description of how to use the Bathymetry Editor for creating a bathymetry data file is included with the installation. Please find this example in your installation folder under Examples\MIKEZero\BatEdit.

The bathymetry data file is a dfs2 file which contains the bathymetry (Bed elevation) and the following geographical information of the computational domain

- The map projection
- The geographical position of the grid origin
- The grid orientation.

The grid orientation is defined as the angle between true north and the y-axis of the model measured clockwise. A mnemonic way of remembering this definition is by thinking of NYC, which normally means **New York City**, but which for our purpose means "from **N**orth to the **Y**-axis **C**lockwise", see Figure 5.3.

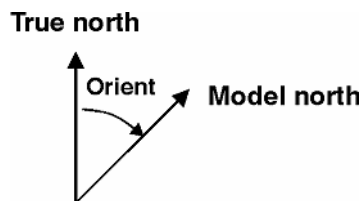

Figure 5.3 Definition of model orientation

The bathymetry data file also contains information of the true land value. True land value is the minimum value you have specified for land points when you prepared the bathymetry. All grid points with a depth value equal to or greater than the value you specify will be excluded from the computational domain. The value representing land is the fourth element in the custom block called M21_Misc which consists of 7 elements of type float. The computational mesh is shown in the graphical view.

The bathymetry data file does not contain any information of the boundaries. Therefore starting at the grid origin and going counter-clockwise a boundary code (2, 3, 4 ...) is set for each open boundary section of the grid. The boundary codes can be seen by clicking on the graphical view and select "Show mesh".

The bathymetry data file can also be converted to a mesh file using the MIKE Zero Mesh Converter Tool. This will allow you to edit the boundary codes using the MIKE Zero Data Viewer. Note, that a simulation using a mesh file will give different result than using the bathymetry data file directly due to the



difference in the determination of the bed elevation in the cell center (see Bed elevation).

Bed elevation

Using a mesh file for specification of the mesh and bathymetry, the bed elevation is given at the nodes (vertices) of the elements. The governing equations are solved using a cell-centred finite volume approach. Here the bed level is required at the cell center. This bed level is determined as the mean value of the node values.

Using a bathymetry data file for specification of the mesh and bathymetry, the bed elevation at the cell center of the elements is determined as the bed elevation specified in the input data file. The bed elevation at the nodes is determined as the area-weighted mean values of the bed elevation in the elements connected to the node and the weight factors are the areas of the connected elements.

5.1.2 Domain specification

Map projection

When the mesh is specified using a mesh file generated by the MIKE Zero Mesh Generator or the mesh is specified using a bathymetry data file generated by the MIKE Zero Bathymetry Editor the map projection is defined in the input data file and is only shown for reference in the user interface. If the map projection is **not** defined in the mesh file, you have to select the correct map projection corresponding to the data in the mesh file

Minimum depth cutoff

If the bathymetry level in an element is above the minimum depth cutoff value then the minimum depth cutoff value is replacing the actual bathymetry value in the computations. Please note that the minimum depth cutoff value may be negative as the bathymetry levels is often so in the mesh file.

If you also apply a Datum shift - the depth cutoff is relative to the corrected depths.

For instance - you have a mesh file with values between +2 and -20 meters. You then shift these to a different datum with a shift of +1 meters. Your corrected bathymetry now ranges between +1 and -21 m. You can then cutoff all depths above -2m, leaving the bathymetry used in the model to range between -2 and -21 m.

Datum shift

You can use any convenient datum for setting up the mesh of your model. This can be Chart Datum (CD), Lowest Astronomical Tide (LAT) or Mean Sea Level (MSL). The actual datum is unimportant.



What is important, however, is that for each simulation you must provide the model with the correct height of the model reference level relative to the datum used in the setup of your bathymetry. Specifying the datum shift does this. In this way it is possible to carry out simulations using a range of different water levels without having to alter the mesh file.

If you do not plan to apply different water levels in different simulations it is recommended that you set up your bathymetry with the datum that you plan use in the simulations, thus having a datum shift of 0 m.



Note: A datum shift of e.g. 2 m (-2 m) means the water depth is increased (decreased) by 2 m in all node points.

Mesh decomposition

To improve the performance of the numerical scheme when using only one subdomain in the simulation it is possible to include reordering of the mesh (renumbering of the element and node numbers). This can significantly speed up the computational time by optimizing the memory access. If reordering is included, the numbering of the elements and nodes in the log file and in the output dfsu files will be different compared to the numbering in the input mesh.

If the simulation is carried out using several subdomains, reordering is always performed at subdomain level, but here the numbering of the elements and nodes in the log file and in the output dfsu files will be the same as for the input mesh.



PLEASE NOTE:

When executing a flexible mesh model in decoupled mode the interpretation of the decoupled files depends on the numbering of the elements and nodes. Hence, if reordering is specified for a simulation using only one subdomain then the decouplings files can only be applied for a decoupled simulation using only one domain where reordering is also specified.

5.1.3 Vertical mesh

In the vertical domain a layered mesh is applied. Two different types of the mesh can be used:

- Sigma
- Combined sigma/z-level

Sigma

In the sigma domain the vertical distribution of the layers can be specified in three different ways:

- Equidistant



- Layer thickness
- Variable

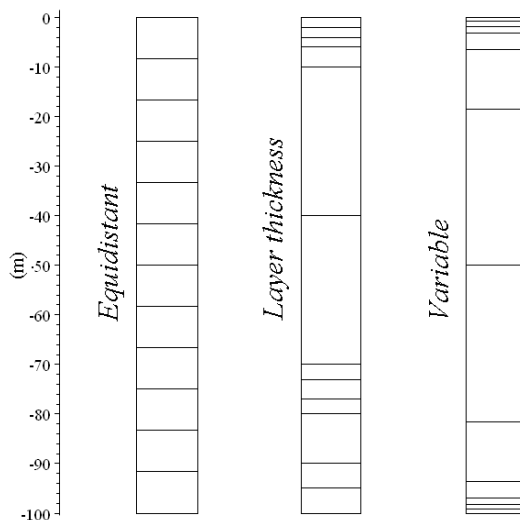

Figure 5.4 Examples of vertical distribution of layers for a water column 100 m deep. A number of 12 layers has been applied for all three options.
Left column: Equidistant distribution
Middle column: Layer thickness distribution
Right column: Variable distribution

For all three options you must specify the number of vertical layers (elements).

Selecting equidistant distribution, the layers are distributed equidistant across the water depth.

Selecting layer thickness distribution, the fraction of each layer's thickness across the water depth must be specified. Note that the sum of the values for the layer thickness must be equal to 1.

Selecting variable distribution, you must specify three vertical distribution parameters:

1. σ_c (σ_c)
 σ_c is a weighting factor between the equidistant distribution and the stretch distribution. The range is $0 < \sigma_c \leq 1$. The value 1 corresponds to equidistant distribution and 0 corresponds to stretched distribution. A small value of σ_c can result in linear instability.
2. θ (θ)
 θ is the surface control parameter. The range is $0 < \theta \leq 20$.



3. b is the bottom control parameter. The range is $0 \leq b \leq 1$.

The variable s -coordinates are obtained using a discrete formulation of the general vertical coordinate (s -coordinate) system proposed by Song and Haidvogel (1994).

If $\theta \ll 1$ and $b=0$ an equidistance vertical resolution is obtained. By increasing the value of θ , the highest resolution is achieved near the surface. If $\theta > 0$ and $b=1$ a high resolution is obtained both near the surface and near the bottom.

A detailed description of the equations behind the variable distribution can be found in the scientific documentation for MIKE 21 & MIKE 3 Flow Model FM, Hydrodynamic and Transport Module.

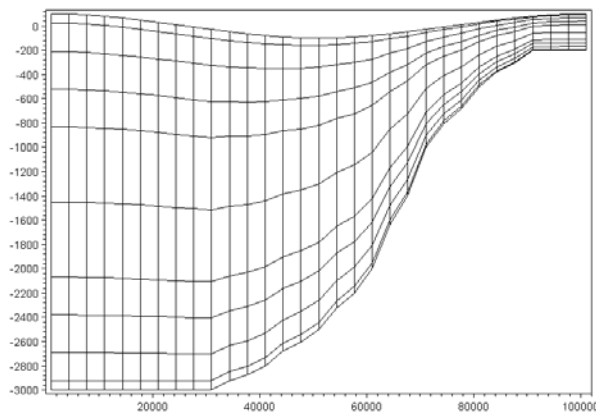

Figure 5.5 Example of vertical distribution using layer thickness distribution. Number of layers: 10, thickness of layers 1 to 10: 0.025,0.075,0.1,0.1,0.2,0.2,0.1,0.1,0.075,0.025

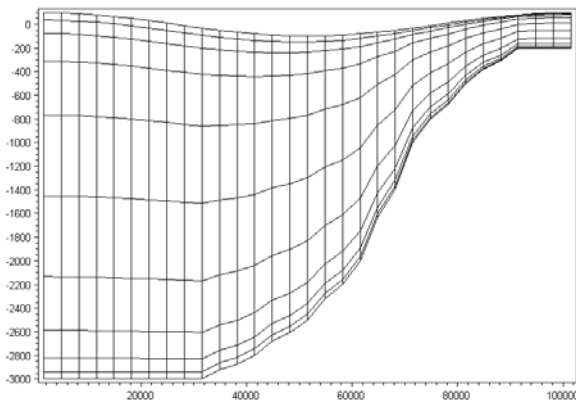

Figure 5.6 Example of vertical distribution using variable distribution. Number of layers: 10, $\sigma_c = 0.1$, $\theta = 5$, $b = 1$

Combined sigma/z-level

For the combined sigma/z-level mesh sigma coordinates are used from the free surface to a user specified level (sigma depth) and below that z-level coordinates are used.

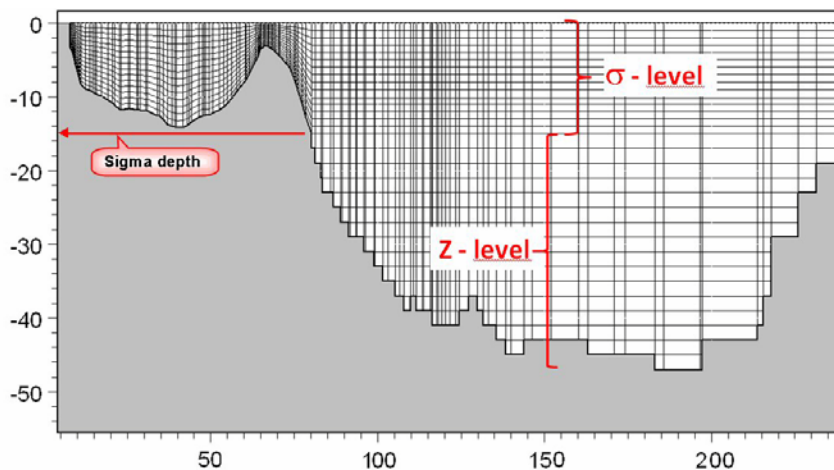

Figure 5.7 Example of vertical distribution using combined sigma/z-level

When flood and dry is included in the simulation, the flooding and drying (see Flood and Dry (p. 39)) is restricted to areas within the sigma domain. Therefore the sigma depth must be selected so that the minimum water level during the simulation does not become lower than sigma depth.

The specification of the mesh in the sigma domain is done as described in the previous section (see p. 25). In the z-level domain the vertical distribution of the layers can be specified in two different ways:



- Equidistant
- Layer thickness

For both options you must specify the number of vertical layers (elements) and the sigma depth.

Selecting Equidistant distribution the constant layer thickness must be specified.

Selecting Layer thickness distribution the thickness of each layer must be specified. Layer 1 correspond to the bottom layer, layer 2 correspond to the second layer from the bottom and so on.

The type of bathymetry adjustment can be specified in two ways:

- Simple adjustment
- Advanced adjustment

When selecting simple adjustment, the bottom depth is rounded to the nearest depth except when the bottom depth is below the minimum z-level. Here a bottom fitted approach is applied to take into account the correct depth.

When selecting advanced adjustment, a bottom fitted approach is applied in the whole z-level domain which allows the correct depth to be taken into account. Using the advanced adjustment you must also specify a minimum layer thickness. Normally, it can be specified as 1/100 of the constant layer thickness when the option Equidistant distribution is selected and correspondingly 1/100 of the minimum layer thickness when the option Layer thickness distribution is selected.

Depth correction

When combined sigma/z-level mesh is applied for the vertical discretization the correction bathymetry is limited. If “Simple adjustment” is selected for the bathymetry adjustment, depth correction and morphological changes due to sediment transport are not allowed. If “Advanced adjustment” is selected for the bathymetry adjustment only small corrections of the bathymetry are possible. The correction factor for the layer thickness is not allowed to be less than zero or larger than one except for the bottom cell.

A detailed description of the bottom fitted approach can be found in the scientific documentation for MIKE 21 & MIKE 3 Flow Model FM, Hydrodynamic and Transport Module.

Remarks and hints

Although, a bottom fitted approach can be applied in which the correct depth is taken into account, the flow at the bottom still needs to pass obstacles either sideways or upwards whenever encountered. Therefore smoothing of bathymetry may improve the results.



5.1.4 Boundary names

When the mesh is specified using a mesh file generated by the MIKE Zero Mesh Generator you have already defined a code value for the boundaries. Figure 5.8 shows the definition of codes in a simple application. In this case the three open boundaries have been detected from the mesh file specified in the domain dialog.

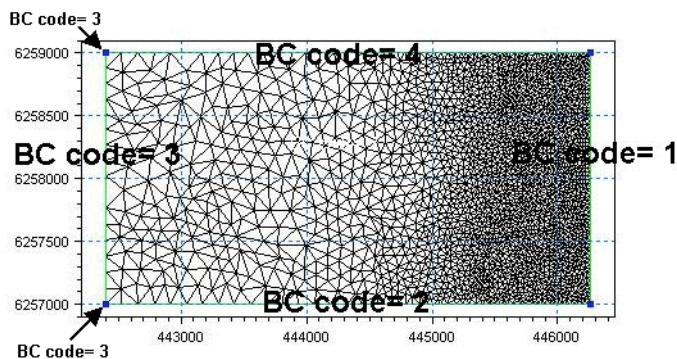

Figure 5.8 The definition of boundary codes in a mesh is made in the Mesh Generator

When the mesh is specified using a bathymetry data file generated by MIKE Zero Bathymetry Editor the boundary codes is defined as described on the Domain dialog.

In the main Boundary names dialog you can re-name the code values to more appropriate names, see Figure 5.9.

Boundary	Name
Code 3	Code 3
Code 2	Code 2
Code 4	Code 4



Boundary	Name
Code 3	West BC
Code 2	South BC
Code 4	North BC

Figure 5.9 Change of default code names (from the mesh file) to more appropriate names

5.1.5 Material and infrastructure

The domain can be divided into different zones. For inland flooding applications the zones are used to represent the land use/land cover, e.g. forest, shrubland/grass, wetlands, bare earth/gravel/rock, crops/pasture, rivers /lakes, buildings and roads. For marine application the zone information can be used to represent areas with different type of bed material.



There are three types of zones: Material zones and two type of infrastructure zones (Building zones and Road zones). The definition of zones must be specified separately for the three types of zones. Three types of file format can be used for defining the zones

- dfs file
- xyz file
- shape file

For the dfs file, the zones are defined by a map identifying the location of the different zones. Each zone is identified by an integer number larger than zero. If no zone is specified, the value should be zero. For the xyz file and the shape file, the zones are defined as the closed region within a number of polygons. If there are overlapping zones for the three types of zones the priority is: Building, road and material. Elements where no zone is specified are defined as part of a global zone (material) zone. If an element belongs to more than one polygon in the xyz file or the shape file, the information from the last polygon read from the file is applied.

The bathymetry should be given as natural ground level and for buildings and roads it is possible to specify a correction of the bathymetry.

In the material, building and road zone dialogs you can re-name the zone names to more appropriate names. In the building zone dialog, it is possible to specify if the building should be included or excluded from the calculation. If the buildings are excluded, the building elements will be treated as dry elements.

The zone information can be used to define the roughness (bed friction) and infiltration in the hydrodynamic calculations. For buildings and roads there is a special treatment of the flux across infrastructure faces. For more details see Infrastructure (p. 64).

Building zones

Using a dfs file, the height of a building is specified by the level of the top of the building. Using a xyz file or a shape file, the height of the buildings can be specified in two ways

- Height
- Level

If "Height" is selected, you must specify the height of the buildings as the distance from the natural ground level to the highest point of the building. The top level of the building is then calculated from the maximum ground level in the area of the building. If "Level" is selected, the height of the building is specified as the top level of the building.



The correction of the bathymetry to account for the height of the buildings can be specified in two ways

- Constant
- From file

If "Constant" is selected, you must specify the height or level as a constant value for each building zone.

Road zones

Using a dfs file, the offset bathymetry can be specified in two ways

- Constant
- From file

If "Constant" is selected, you must specify the offset as a constant value for each road zone. Using a xyz file or a shape file, the offset can only be specified as a constant value for each road zone.

Data

dfs file

You must prepare a data file containing an item with the zone numbers. For building zones, the file must also contain an item with height or level when "From file" is specified for the height format. For road zones the file must also contain an item with the offset when "From file" is specified for the offset format. The file must be a 2D unstructured data file (dfs1) or a 2D grid data file (dfs2). The area in the data file must cover the model area. For both a dfs1 file and a dfs2 file piecewise constant interpolation is used to map the data. The input data file must contain only a single time step.

xyz file

The data in the file must be formatted as ASCII text in five columns with the two first columns giving the x-and y-coordinates of the points. The third column represents connectivity. The connectivity column is used to define arcs. All points along an arc - except the last point - shall have a connectivity value of 1 and the last point shall have a connectivity value of 0. The fourth column contains the z-value at the point. Finally, the fifth column contains the zone number. The z-coordinates is only used when the xyz file is used to define building zones. Here the z-value must contain the height of the buildings or the level of the top of the buildings.

You must select the map projection (Long/Lat, UTM-32, etc.) in which you want to specify the horizontal location of the points.

shape file

The shape file format is a geospatial vector data format for geographic information system (GIS) software. To use a shape file to define zones, the shape



type must be either Polygon, PolygonZ or PolygonM. The zone numbers must be written as a field in the dbf-file. The zone numbers must be integers larger than 0 for each polygon. If the height or level of buildings are specified from file they must also be written as a field in the dbf-file. Any empty record value of a field will be read as 0. This means that all zone-values must be given and any building with an empty height or level record will have that height or level set to 0.

In the shape file selector you specify the map projection in which the data is given when you click on “Conversion”. If a .prj file is included in the shape file data, the projection is obtained from this file. If there is no .prj file available you need to specify the map projection.

5.2 Time

The period to be covered by the simulation is specified in this dialog. You have to specify the simulation start date, the overall number of time steps and the overall time step interval. The overall discrete time steps specified on this page are used to determine the frequency for which output can be obtained from the different modules and to synchronize the coupling between the different modules.

The simulation always starts with time step number 0 and the simulation start date is the historical data and time corresponding to time step 0. The simulation end date is presented for reference.

5.2.1 Remarks and hints

Each of the various modules in MIKE 3 Flow Model FM use an internal time step, see Figure 5.10.

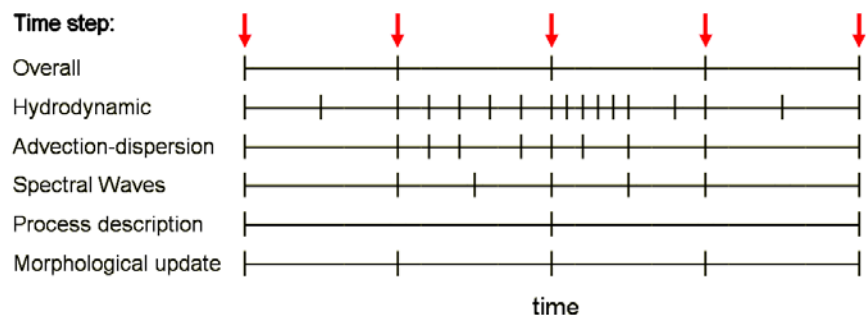

Figure 5.10 Overall time step related to internal time step

The time steps for the hydrodynamic calculations, the advection-dispersion calculations and the spectral waves calculations are dynamic and each determined to satisfy stability criterias.



All time steps within the simulation for the various modules are synchronized at the overall discrete time step. The time step for the hydrodynamic calculations is synchronized at the time step for the advection/dispersion calculations. For the Sand Transport module and the MIKE ECO Lab module the time step for updating the process description can be a multiple of the overall time step.

5.3 Module Selection

The MIKE 3 Flow Model FM comprises various modules, which you can select to be included in the simulation.

You can make your selection to explicitly include the following modules

- Transport
- MIKE ECO Lab / Oil Spill
- Mud Transport
- Particle Tracking
- Sand Transport

by ticking one, or more, of the check boxes.

The Hydrodynamic model is obligatory.



6 HYDRODYNAMIC MODULE

The hydrodynamic module calculates the resulting flow and distributions of salt, temperature, subject to a variety of forcing and boundary conditions. Baroclinic effect due to salt and temperature variations, and turbulence, are considered as subordinated to the HD module and are set up here.

6.1 Basic Equations

The flow is calculated using either the full 3D Navier-Stokes equations or the 3D shallow water equations, where the latter invokes a hydrostatic pressure assumption. For simulations where the non-hydrostatic pressure is essential for capturing the correct behavior of the flow, e.g. internal wave generation due to density variations, it is necessary to use the Navier-Stokes equations.

The simulation times will be longer when using the Navier-Stokes equations rather than the shallow water equations, since the calculation of the non-hydrostatic pressure in the Navier-Stokes equations requires solving a large, sparse, linear system of equations, which is a task that is computationally relative expensive.

For the Navier-Stokes equations it is only possible to use the higher-order scheme in time and space.

6.2 Solution Technique

The simulation time and accuracy can be controlled by specifying the order of the numerical schemes that are used in the numerical calculations. Both the scheme for time integration and for space discretization can be specified. You can select either a lower order scheme (first order) or a higher order scheme. The lower order scheme is faster, but less accurate. For more details on the numerical solution techniques, see the scientific documentation.

For the Navier-Stokes equations it is only possible to use the higher-order scheme in time and space.

The time integration of the flow equations and the transport (advection-dispersion) equations is performed using a semi-implicit scheme, where the horizontal terms are treated explicitly and the vertical terms are treated implicitly. Due to the stability restriction using an explicit scheme the time step interval must be selected so that the CFL number (p. 36) is less than 1. A variable time step interval is used in the calculation of both the flow equations and the transport equations determined so that the CFL number is less than a critical CFL number in all computational nodes. The CFL number for the transport equations is usually less restrictive than the CFL number for the flow equations. Hence, a larger time step interval is normally used for the



transport equations than the flow equations. To control the time step it is also possible for the user to specify a minimum time step and a maximum time step. The time step interval for the transport equations is synchronized to match the overall time step and the time step interval for the flow equations is synchronized to match the time step interval for the transport equations.

The flow equations are discretized using a finite volume method with a shock-capturing scheme where the interface fluxes are calculated using an approximate Riemann solver. For the Navier-Stokes equations the HLLC Riemann solver (Toro et al. (1994)) is applied while for the shallow water equations the Roe's scheme (Roe (1981)) is applied. The shock-capturing scheme enables robust and stable simulation of flows involving shocks or discontinuities such as bores and hydraulic jumps.

For the Navier-Stokes equations the type of Riemann solver can be specified in two ways

- No Riemann solver
- HLLC

Selecting the Riemann solver you have to specify the Riemann factor.

For fast varying flows with a coarse resolution the HLLC solver can be too diffusive.

The HLLC solver includes four stages. For two stages simple upwinding is applied for calculating the interface fluxes. For the two additional stages the energy dissipation is a function of the difference between the left and right Riemann states (flow variables). To be able to control the numerical dissipation a Riemann factor is applied to the calculated difference of the Riemann states. The factor should be ≥ 0 and ≤ 1 . The value 1 corresponds to the full HLLC solver.

For some applications the numerical solutions can be contaminated by divergence noise modes. This can be seen as checker-board oscillations in the horizontal velocity field. To constrain the noise an explicit filtering of the horizontal velocity field can be applied. For more details see the Scientific documentation. The user can specify the filtering factor, which for most applications should be in the range between 0.001 and 0.02.

6.2.1 CFL number

For the flow equations in Cartesian coordinates the Courant-Friedrich-Lévy (CFL) number is defined as

$$CFL_{HD} = (\sqrt{gh} + |u|) \frac{\Delta t}{\Delta x} + (\sqrt{gh} + |v|) \frac{\Delta t}{\Delta y} \quad (6.1)$$



where h is the total water depth, u and v are the velocity components in the x - and y -direction, respectively, g is the gravitational acceleration, Δx and Δy are a characteristic length scale in the x - and y -direction, respectively, for an element and Δt is the time step interval. The characteristic length scale, Δx and Δy , is approximated by the minimum edge length for each element and the water depth and the velocity component is evaluated at element center.

For the transport equations in Cartesian coordinates the CFL number is defined as

$$CFL_{AD} = |u| \frac{\Delta t}{\Delta x} + |v| \frac{\Delta t}{\Delta y} \quad (6.2)$$

6.2.2 Remarks and hints

If the important processes are dominated by convection (flow), then higher order space discretization should be chosen. If they are dominated by diffusion, the lower order space discretization can be sufficiently accurate. In general, the time integration method and space discretization method should be chosen alike.

Choosing the higher order scheme for time integration will increase the computing time by a factor of 2 compared to the lower order scheme. Choosing the higher order scheme for space discretization will increase the computing time by a factor of 1½ to 2. Choosing both as higher order will increase the computing time by a factor of 3-4. However, the higher order scheme will in general produce results that are significantly more accurate than the lower order scheme.

The stability of the numerical scheme should be secure if the CFL number less than 1. However, the calculation of the CFL number is only an estimate. Hence, stability problems can occur using this value. In these cases you can reduce the critical CFL number. Therefore the default value of the critical CFL number is set to 0.8. It must be in the range from 0 to 1. Alternatively, you can reduce the maximum time step interval. Note, that setting the minimum and maximum time step interval equal to the overall time step interval specified on the Time dialog (p. 33), the time integration will be performed with constant time step. In this case the time step interval should be selected so the the CFL number is smaller than 1.

For both the time integration of the flow equations and the transport equations, the total number of time steps in the calculation and the maximum and minimum time interval during the calculation are printed in the log-file for the simulation. The CFL number can be saved in an output file.



6.3 Depth Correction

It is possible to define a correction, Δz , to the defined mesh bathymetry to be included in the simulations.

This utility can be applied for e.g. a morphology hotstart where bed changes need to be accounted for in a continuation of a previous simulation or in tsunami modelling to simulate the bed level fluctuations during an earthquake.

If included in the simulation, a data file with the depth correction values must be specified.



Note: It is not possible to apply a time-varying depth correction map in a simulation where morphological update of the bed level is applied as well.

Data

The format of the bathymetry correction can be specified as

- Varying in space, constant in time
- Varying in space, varying in time

The file must be a 2D unstructured data file (dfsu) or a 2D grid data file (dfs2). The area in the data file must cover the model area. If a dfsu-file is used piecewise constant interpolation is used to map the data. If a dfs2-file is used, bilinear interpolation is used to map the data.

In case the bathymetry correction is defined as constant in time, the first time step in the bathymetry correction data file is applied as an initial condition in the simulation. In case the bathymetry correction is defined as varying in time, the bathymetry correction data must cover the complete simulation period.

6.3.1 General description

The corrected still water depth, $d_{corrected}$, is defined as

$$d_{corrected} = d_{initial} - \Delta z \quad (6.3)$$

where $d_{initial}$ is the initial water depth. A positive value for Δz will decrease the still water depth and a negative value will increase the still water depth.

At the initial time step the still water depth is corrected and the initial conditions for the surface elevation or water depth is satisfied. For the following time steps using time varying depth correction the still water depth is corrected and the surface elevation is corrected correspondingly to secure mass conservation.



6.4 Flood and Dry

The flood and dry can be specified in two different ways

- No flood and dry
- Flood and dry

If your model is located in an area where flooding and drying occur, you must enable the flood and dry facility by selecting "Flood and dry". In this case you have to specify a drying water depth and a wetting depth.

When the water depth is less than the wetting depth the problem is reformulated and only if the water depth is less than the drying depth the element/cell is removed from the simulation. The reformulation is made by setting the momentum fluxes to zero and only taking the mass fluxes into consideration.

If flooding and drying is not enabled, you should specify a minimum depth cut-off (see Section 5.1.2, Domain specification), which is less than zero. If the total water depth becomes less than zero a blow-up is detected and the simulation halted.

6.4.1 General description

The approach for treatment of the moving boundaries (flooding and drying fronts) problem is based on the work by Zhao et al. (1994) and Sleigh et al. (1998). When the depths are small the problem is reformulated and only when the depths are very small the elements/cells are removed from the calculation. The reformulation is made by setting the momentum fluxes to zero and only taking the mass fluxes into consideration.

The depth in each element/cell is monitored and the elements are classed as dry, partially dry or wet. Also the element faces are monitored to identify flooded boundaries.

- An element face is defined as flooded when the water depth at one side of face is less than a tolerance depth, h_{dry} , and the water depth at the other side of the face larger than a tolerance depth, h_{wet} .
- An element is dry if the water depth is less than a tolerance depth, h_{dry} , and no of the element faces are flooded boundaries. The element is removed from the calculation.
- An element is partially dry if the water depth is larger than h_{dry} and less than a tolerance depth, h_{wet} , or when the depth is less than the h_{dry} and one of the element faces is a flooded boundary. The momentum fluxes are set to zero and only the mass fluxes are calculated.
- An element is wet if the water depth is greater than h_{wet} . Both the mass fluxes and the momentum fluxes are calculated.



A non-physical flow across the face will be introduced for a flooded face when the surface elevation in the wet element on one side of the face is lower than the bed level in the partially wet element on the other side. To overcome this problem the face will be treated as a closed face.

In case the water depth become negative, the water depth is set to zero and the water is subtracted from the adjacent elements to maintain mass balance. When mass is subtracted from the adjacent elements the water depth at these elements may become negative. Therefore an iterative correction of the water depth is applied (max. 100 iterations).



Note: When an element is removed from the calculation, water is removed from the computational domain. However, the water depths at the elements, which are dried out, are saved and then reused when the element becomes flooded again.

6.4.2 Recommended values

The default values are: drying depth $h_{dry} = 0.005\text{m}$ and wetting depth $h_{wet} = 0.1\text{m}$. The wetting depth, h_{wet} , must be larger than the drying depth, h_{dry} .

In case of floodplain simulations the values for wetting depth and drying depth should be decreased in order to minimize the water balance error. A reduction factor in the order of up to 50 can be recommended.

6.4.3 Remarks and hints

For very small values of the tolerance depth, h_{wet} , unrealistic high flow velocities can occur in the simulation and give cause to stability problems.

6.5 Density

The density is assumed to be a function of salinity and temperature. If you select barotropic mode, both temperature and salinity (TS) will be constant and the density will not be updated during the simulation. When the density is considered to be a function of temperature and/or salinity (baroclinic mode), the transport equation for the temperature and/or salinity must be solved. The solution of these equations is automatically invoked and the density is updated from the TS fields.

The specification of the setup for the solution of additional transport equations is described in the Section 7 TEMPERATURE/SALINITY MODULE.

The density is calculated using UNESCO's standard equation of state for sea water. These relations are applicable for temperatures ranging from $-2.1\text{ }^{\circ}\text{C}$ to $40.0\text{ }^{\circ}\text{C}$ and salinities in the range from 0 to 45 PSU (Practical Salinity Unit).



The reference temperature and salinity can be used to improve the accuracy of the density calculation, as these are subtracted from the TS fields before the density calculation. If density is a function of temperature alone, the density is calculated using the actual temperature and the reference salinity, and vice versa for salinity.

6.5.1 Remarks and hints

If the density is included, the CPU time for the simulation is increased significantly as one or two additional transport equations are solved.

6.6 Eddy Viscosity

The decomposition of the prognostic variables into a mean quantity and a turbulent fluctuation leads to additional stress terms in the governing equations to account for the non-resolved processes both in time and space. By the adoption of the eddy viscosity concept these effects are expressed through the eddy viscosity and the gradient of the mean quantity. Thus the effective shear stresses in the momentum equations contain the laminar stresses and the Reynolds stresses (turbulence).

6.6.1 Horizontal eddy viscosity

The horizontal eddy viscosity can be specified in four different ways

- No eddy
- Constant eddy formulation
- Smagorinsky formulation
- k - ε formulation

Selecting the constant eddy formulation you must specify the eddy coefficient, and selecting Smagorinsky formulation you must specify the Smagorinsky coefficient.

Selecting the k - ε formulation the eddy viscosity is determined as function of the turbulent kinetic energy (TKE), k , and the dissipation of TKE, ε . The two additional transport equations must be solved for the TKE and the dissipation of TKE. The solution of these equations is automatically invoked. The specification of the setup for the solution of the additional transport is described in Section 8 TURBULENCE MODULE.

Data

The format of the eddy viscosity coefficient, or the Smagorinsky coefficient, can be specified as



- Constant (in domain)
- Varying in domain

For the case with values varying in domain the values vary in the horizontal domain only. The values are constant in the vertical domain.

For the case with values varying in domain you have to prepare a data file containing the eddy viscosity coefficient or the Smagorinsky coefficient before you set up the hydrodynamic simulation. The file must be a 2D unstructured data file (dfsu) or a 2D grid data file (dfs2). The area in the data file must cover the model area. If a dfsu-file is used piecewise constant interpolation is used to map the data. If a dfs2-file is used bilinear interpolation is used to map the data.

Eddy parameters

Using the Smagorinsky formulation you must specify a minimum and maximum value for the eddy viscosity.

6.6.2 Vertical Eddy Viscosity

The vertical eddy viscosity can be specified in four different ways

- No eddy
- Constant eddy formulation
- Log law formulation
- k - ε formulation

Selecting the constant eddy formulation you must specify the eddy coefficient, ν_t .

The log law formulation uses a parabolic eddy coefficient, scaled with local depth and bed and surface stresses.

Selecting the k - ε formulation the eddy viscosity is determined as function of the turbulent kinetic energy (TKE), k , and the dissipation of TKE, ε . The two additional transport equations must be solved for the TKE and the dissipation of TKE. The solution of these equations is automatically invoked. The specification of the setup for the solution of the additional transport is described in Section 8 TURBULENCE MODULE.

Data

Using the constant eddy formulation the eddy viscosity coefficient ν_t can be specified in two different ways

- Constant (in domain)



- Varying in domain

For the case with values varying in domain the values are constant in the vertical domain and only varying in the horizontal domain. You have to prepare a data file containing the eddy viscosity coefficient before you set up the hydrodynamic simulation. The file must be a 2D unstructured data file (dfs1) or a 2D grid data file (dfs2). The area in the data file must cover the model area. If a dfs1-file is used piecewise constant interpolation is used to map the data. If a dfs2-file is used bilinear interpolation is used to map the data.

Damping

When using the constant eddy formulation or the log-law formulation you can include a dependency on the vertical stratification by a Richardson number type damping. In that case you must specify the two coefficients a and b in the generalization of the Munk-Anderson formulation (see Section 6.6.3 General description).

Eddy parameters

Using the constant eddy or the log-law formulation you may specify a minimum and maximum value for the eddy viscosity.

6.6.3 General description

Smagorinsky formulation

Smagorinsky (1963) proposed to express sub-grid scale transports by an effective eddy viscosity related to a characteristic length scale. The sub-grid scale eddy viscosity in the horizontal direction is given by

$$\nu_t^h = c_s^2 l^2 \sqrt{2 S_{ij} S_{ij}} \quad (6.4)$$

where c_s is a constant, l is a characteristic length and the deformation rate is given by

$$S_{ij} = \frac{1}{2} \left(\frac{\partial u_i}{\partial x_j} + \frac{\partial u_j}{\partial x_i} \right) \quad (i, j = 1, 2) \quad (6.5)$$

For more details on this formulation, the reader is referred to Lilly (1967), Leonard (1974), Aupoix (1984), and Horiuti (1987).

Log law formulation

The vertical eddy viscosity derived from the log-law is calculated by

$$\nu_t^v = U_\tau h + \left(c_1 \frac{z+d}{h} + c_2 \left(\frac{z+d}{h} \right)^2 \right) \quad (6.6)$$



where $U_\tau = \max(U_{\tau s}, U_{\tau b})$, c_1 and c_2 are two constants, d is the still water depth and h is the total water depth. $U_{\tau s}$ and $U_{\tau b}$ are the friction velocities associated with the surface and bottom stresses, $c_1 = 0.41$ and $c_2 = -0.41$ gives the standard parabolic profile.

In applications with stratification the effects of buoyancy can be included explicitly. This is done through an introduction of Richardson number dependent damping of the eddy viscosity coefficient, when stable stratification occurs. The damping is a generalisation of the Munk-Anderson formulation (see Munk and Anderson, 1948)

$$v_t^v = v_t^*(1 + a Ri)^{-b} \quad (6.7)$$

where v_t^* is the undamped eddy viscosity and Ri is the local gradient Richardson number

$$Ri = -\frac{g}{\rho_0} \frac{\partial \rho}{\partial z} \left(\left(\frac{\partial u}{\partial z} \right)^2 + \left(\frac{\partial v}{\partial z} \right)^2 \right)^{-1} \quad (6.8)$$

$a = 10$ and $b = 0.5$ are empirical constants.

***k*- ε formulation**

The k - ε formulation can be used for both the horizontal eddy viscosity v_t^h , and the vertical eddy viscosity, v_t^v . Here it is assumed that $v_t = v_t^h = v_t^v$.

In the k - ε model the eddy-viscosity is derived from turbulence parameters k and ε using

$$v_t = c_\mu \frac{k^2}{\varepsilon} \quad (6.9)$$

where k is the turbulent kinetic energy per unit mass (TKE), ε is the dissipation of TKE and c_μ is an empirical constant.

6.6.4 Recommended values

The Smagorinsky coefficient, C_S , should be chosen in the interval of 0.25 to 1.0.

A minimum value for the eddy viscosity can be chosen to zero, but more useful is a value in the order of the molecular viscosity. When applying k - ε model, it is recommended you use minimum values, which are consistent with the expression for determination of the eddy viscosity, i.e. $k_{\min} = 1.0 \cdot 10^{-7} \text{ m}^2/\text{s}^2$ and $\varepsilon_{\min} = 5 \cdot 10^{-10} \text{ m}^2/\text{s}^3$, yielding $= 1.8 \cdot 10^{-6} \text{ m}^2/\text{s}$.



6.6.5 Remarks and hints

In the same way as for the bed resistance you can use the eddy coefficients to damp out numerical instability (see section 6.7 Bed Resistance). You should only use this as a last resort to your stability problem: The schematisation of the bathymetry and the boundary conditions are usually the primary causes for a blow-up.

When you use the Smagorinsky formulation of the turbulence the CPU time for a simulation is increased.

When you use the $k-\varepsilon$ model formulation of the turbulence the CPU time for the simulation is increased significantly as two transport equations are solved.

6.7 Bed Resistance

The bed resistance can be specified in four different ways

- No bed resistance
- Quadratic drag coefficient
- Roughness height
- Wave induced bed resistance

Selecting one of the middle options you must specify the quadratic drag coefficient and the roughness height, respectively. Selecting the last option you must specify the grain diameter, the relative density of the bed material and some wave induced bed resistance parameters.

If the user has selected either "Include material zones", "Include building zones" or "Include road zones" on the "Material" or "Infrastructure" tab, then you can specify the type of domain input

- Whole domain
- Zone map

Data

When no zone map is specified on the "Domain" page or "Whole domain" is selected for the type of domain input, the format of the drag coefficient, the roughness height, k_s , and the grain diameter, d_{50} , can be specified in one of three ways

- Constant (in time and domain)
- Constant in time, varying in domain
- Varying in time and domain



For the case with values varying in domain you have to prepare a data file containing the drag coefficient, the roughness height or the grain diameter before you set up the hydrodynamic simulation. The file must be a 2D unstructured data file (dfsu) or a 2D grid data file (dfs2). The area in the data file must cover the model area. If a dfsu-file is used piecewise constant interpolation is used to map the data. If a dfs2-file is used bilinear interpolation is used to map the data. If the data is varying in time the data must cover the complete simulation period. The time step of the input data file does not, however, have to be the same as the time step of the hydrodynamic simulation. A linear interpolation will be applied if the time steps differ.

When "Zone map" is specified for the type of domain input and the resistance type is specified as "Quadratic drag coefficient", "Roughness height" or "Wave induced bed resistance", you must specify a constant drag coefficient, roughness height or grain diameter for each zone in the domain.

Wave induced bed resistance

Using the wave induced bed resistance formulation you must specify some related parameters.

The type of calculation can be one of two:

- Parameterized
- Non-Parameterized

The applied wave height value can be restricted by the water depth. In case this option is enabled you need to specify the maximum value of the wave height/depth ratio.

You must also specify the Speed-up factor by which the bed resistance from the waves is recalculated. The default value is 1. Note that a value above 1 may lead to instabilities in the results.

6.7.1 General description

The bottom stress, $\overline{\tau_b}$, is determined by a quadratic friction law

$$\frac{\overline{\tau_b}}{\rho_0} = c_f \overline{u_b} |\overline{u_b}| \quad (6.10)$$

where c_f is the drag coefficient, $\overline{u_b}$ is the flow velocity above the bottom and ρ_0 is the density of the water.

For three-dimensional calculations $\overline{u_b}$ is the velocity at a distance Δz_b above the sea bed and the drag coefficient is determined by assuming a logarithmic



profile between the seabed and the point at the distance Δz_b above the seabed

$$c_f = \frac{1}{\left(\frac{1}{\kappa} \ln \left(\frac{\Delta z_b}{z_0}\right)\right)^2} \quad (6.11)$$

where $\kappa=0.4$ is the von Kármán constant and z_0 is the bed roughness length scale. When the boundary surface is rough, z_0 depends on the roughness height,

$$z_0 = mk_s \quad (6.12)$$

where m is approximately 1/30.

The wave induced bed resistance can be determined from

$$c_f = \left(\frac{U_{fc}}{u_b}\right)^2 \quad (6.13)$$

where U_{fc} is the friction velocity calculated by considering the conditions in the wave boundary layer. For a detailed description of the wave induced bed resistance see Fredsøe (1984) and Jones et. al (2014).

6.7.2 Recommended values

If you use Wave induced bed resistance the default value of the sediment density is 2.65, the default value of wave height/depth ratio is 0.85 and the default update value is 1.

The default value of roughness height is 0.05 m. Normally the roughness height lies in the range between 0.01 – 0.3 m.

By definition a small value of the roughness height correspond to low friction and vice versa.

6.7.3 Remarks and hints

If the boundary conditions at one of your boundaries are inaccurate and you therefore have stability problems (blow-ups) at this boundary, you can specify a small area along the boundary with a very high resistance in order to remove noise generated by the boundary. Manning numbers in the range 5 - 10 $m^{1/3}/s$ or roughness heights in the order of 1 m have been applied successfully. However, this method should only be used if it is impossible to



improve the boundary conditions. Furthermore, the simulation results in the area which high bed resistance should be used with caution.

6.8 Coriolis Forcing

The effect of the coriolis force can be included in three different ways

- No Coriolis force
- Constant in domain
- Varying in domain

If the constant in domain option is selected, the Coriolis force will be calculated using a constant specified reference latitude (in degrees).

If the varying in domain option is selected, the Coriolis force will be calculated based on the geographical information given in the mesh file.

6.9 Wind Forcing

It is possible to take into account the effect of the wind on the flow field. The format of the wind data can be specified as

- Constant. The wind is blowing from the same direction and with the same magnitude for the whole simulation period and over the entire model area.
- Varying in time and constant in domain. The magnitude and direction varies during the simulation period but is the same over the entire model area.
- Varying in time and domain. The magnitude and direction varies during the simulation period and over the model area.



NOTE: the directions are given in degrees and measured clockwise from true north to where the wind is blowing from.

Data

For the case with wind varying in time but constant in domain you have to prepare a data file containing the wind speed and direction (in degrees from true North) before you set up the hydrodynamic simulation. The data file must be a time series file (dfs0). This can be done by entering the data in an ASCII file using your normal editor and then reading this file into the standard data file format using the MIKE Zero Time Series Editor. The wind data must cover the complete simulation period. The time step of the wind input data file does not, however, have to be the same as the time step of the hydrodynamic simulation. A linear interpolation of the wind speed and wind direction will be applied if the time steps differ.



For the case with wind varying both in time and domain you have to prepare a data file containing the wind speed components and air pressure before you set up the hydrodynamic simulation. The file must be a 2D unstructured data file (dfs1) or a 2D grid data file (dfs2). This can be done by either using one of the two MIKE 21 wind generating programs (cyclone generated wind and pressure, or wind generated on the basis of digitised pressure fields). Or you can enter the data in an ASCII file using your normal editor and then reading this file into the standard data file format using the MIKE Zero Grid Series Editor. The area in the data file must cover the model area. If a dfs1-file is used, piecewise constant interpolation is used to map the data. If a dfs2-file is used, bilinear interpolation is used to map the data. The wind data must cover the complete simulation period. The time step of the wind input data file does not, however, have to be the same as the time step of the hydrodynamic simulation. A linear interpolation will be applied if the time steps differ.

Neutral pressure

For the case with wind varying in both time and domain, you have to specify a reference or neutral pressure level.

Soft start interval

You can specify a soft start interval during which the wind speed is increased from 0 to the specified wind speed in order to avoid shock waves being generated in the model. By default the soft start interval is zero (no soft start). The wind direction is not altered by the soft start.

6.9.1 Wind friction

The wind friction can be specified either as a constant or varying with the wind speed. In the latter case, the friction is linearly interpolated between two values based on the wind speed and if the wind speed is below the lower limit or above the upper limit the friction is given the value corresponding to that limit.

6.9.2 General description

You can include the effects of a wind blowing over the model area in the following way. The surface stress, $\overline{\tau_s}$, is determined by the wind speed above the water. The stress is given by the following empirical relation

$$\overline{\tau_s} = \rho_a c_d |u_w| \overline{u_w} \quad (6.14)$$

where ρ_a is the density of air, c_d is the empirical drag coefficient of air, and $\overline{u_w} = (u_w, v_w)$ is the wind speed 10 m above the sea surface.



Please notice that the direction of the wind is given in degrees blowing **from** (relative to true north (see Figure 6.1)).

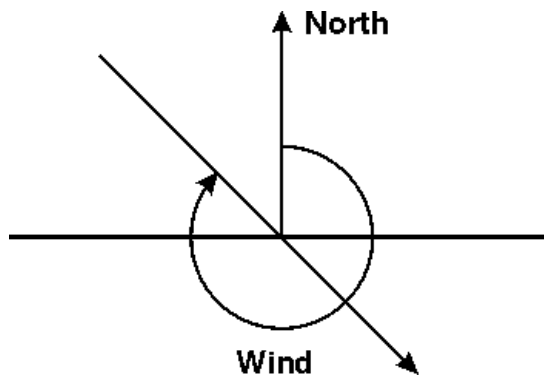

Figure 6.1 Definition of wind direction

The drag coefficient can either be a constant value or depend on the wind speed. The empirical formulae proposed by Wu (1980, 1994) is used for the parametrization of the drag coefficient.

$$c_d = \begin{cases} c_a & w_{10} < w_a \\ c_a + \frac{c_b - c_a}{w_b - w_a} \cdot (w_{10} - w_a) & w_a \leq w_{10} \leq w_b \\ c_b & w_{10} > w_b \end{cases} \quad (6.15)$$

where c_a , c_b , w_a and w_b are empirical factors and w_{10} is the wind speed 10 m above the sea surface.

The default values for the empirical factors are $c_a = 1.255 \cdot 10^{-3}$, $c_b = 2.425 \cdot 10^{-3}$, $w_a = 7$ m/s and $w_b = 25$ m/s. The value gives generally good results for open sea applications. Field measurements of the drag coefficient collected over lakes indicate that the drag coefficient is larger than open ocean data. For a detailed description of the drag coefficient see Geenaert and Plant (1990).

6.9.3 Remarks and hints

You can use the drag coefficient as a parameter in your model calibration.

6.10 Ice Coverage

It is possible to take into account the effects of ice coverage on the flow field. The ice coverage can be specified in four different ways

- No coverage



- Specified ice concentration
- Specified ice thickness
- Specified ice concentration and thickness

For the two cases where the ice concentration (the area coverage ratio of the ice) is specified the effect of the ice is taken into account in areas where the ice concentration becomes larger than a user-specified critical concentration (default value 0.9). For the case where only the ice thickness is specified the effect of the ice is taken into account in areas where the ice thickness is larger than zero.

When specifying ice thickness approximately 90% of the ice is submerged into the water. The precise value is found from $\rho_{\text{ice}}/\rho_{\text{water}}$, where $\rho_{\text{ice}}=917 \text{ kg/m}^3$ and ρ_{water} is the local water density. Note that the water level will be suppressed accordingly.

If included in the simulation, maps of the ice concentration and/or thickness must be specified.

In areas where the sea is covered by ice the wind stress is excluded that is the wind speed is set to zero. Additionally, the effect of the ice roughness on the flow field can be included. For this case you must specify the roughness height.

Ice coverage data

You have to prepare a data file containing the ice concentration and/or thickness before you set up the hydrodynamic simulation. The file must be a 2D unstructured data file (dfs1) or a 2D grid data file (dfs2). The data file must cover the model area. If a dfs1-file is used, piecewise constant interpolation is used to map the data and if a dfs2-file is used, bilinear interpolation is used. The data must cover the complete simulation period. The time step of the input data file does not, however, have to be the same as the time step of the hydrodynamic simulation. A linear interpolation will be applied if the time steps differ.

Critical concentration

In areas where the ice concentration becomes larger than the specified value of the critical concentration, the effect on the flow field is taken into account.

Roughness data

The format of the ice roughness height, k_s , can be specified as

- Constant (in domain)
- Varying in domain



For the case with values varying in domain you have to prepare a data file containing the drag coefficient or the roughness height before you set up the hydrodynamic simulation. The file must be a 2D unstructured data file (dfsu) or a 2D grid data file (dfs2). The data file must cover the model area. If a dfsu-file is used piecewise constant interpolation is used to map the data and if a dfs2-file is used bilinear interpolation is used.

6.11 Tidal Potential

The tidal potential is a force, generated by the variations in gravity due to the relative motion of the earth, the moon and the sun. The forcing acts throughout the computational domain. The forcing is considered as the sum of several harmonic terms, each representing a specific constituent, that are specified separately.

The format of the tidal potential data can be specified as

- Specified from dialog
- Specified from file

Data

The tidal potential is defined by the number of constituents that should be included and each constituent is described by a number of parameters, as shown in Table 6.1, where the parameters for the M_2 tidal constituent are shown as an example. The default is 11 constituents comprising M_2 , O_1 , S_2 , K_2 , N_2 , K_1 , P_1 , Q_1 , M_m , M_f and S_{sa} . There is no limit on the number of constituents that can be defined. The values for other constituents can be found in standard tidal books as for example (Pugh, 1987).

Table 6.1 Specification of the M_2 tidal constituent

Name	M_2	-	
Species	2	-	Semi-diurnal, $i_0=2$, Diurnal, $i_0=1$, Seasonal, $i_0=0$
Constituent	1	-	
Amplitude	0.242334	m	
Earthtide	0.693	-	Factor based on Love numbers
Period scaling	3600		Multiplies Period to obtain seconds
Period	12.42		Period of the constituent
Nodal no. 1	1.0	-	Nodal modulation factor
Nodal no. 2	-0.037	-	Nodal modulation factor
Nodal no. 3	-2.1	°	Nodal factor, angle
Argument 1	0	-	Doodson number, i_1

Table 6.1 Specification of the M_2 tidal constituent

Argument 2	0	-	Doodson number, i_2
Argument 3	0	-	Doodson number, i_3
Argument 4	0	-	Doodson number, i_4
Argument 5	0	-	Doodson number, i_5
Phase	0	°	Phase angle correction

6.11.1 Remarks and hints

The tidal potential is a weak force and is usually significant in deep enclosed water bodies only as e.g. Mediterranean Sea or Gulf of Mexico or in large scale models of e.g. the Pacific Ocean. In model setups with open boundaries, these usually dominates the flow.

6.12 Precipitation-Evaporation

In applications where the rain fall is important for the flow, you can include precipitation in your simulation. The precipitation can be included in three different ways

- No precipitation
- Specified precipitation
- Net precipitation

The net precipitation is the precipitation minus the evaporation. Thus evaporation corresponds to negative net precipitation. Selecting the No precipitation or the Specified precipitation option, evaporation can also be included separately in three different ways

- No evaporation
- Specified evaporation
- Computed evaporation

For the case with computed evaporation the evaporation rate is calculated as part of the latent heat flux. This option can only be selected if both density variations and heat exchange are included.

Selecting the specified precipitation (or net precipitation) option you must specify the precipitation rate. Selecting the specified evaporation option you must specify the evaporation rate.

Data

The format of the precipitation rate (or net precipitation rate) and evaporation rate can be specified as



- Constant (in time and domain)
- Varying in time, constant in domain
- Varying in time and domain

If specified precipitation/evaporation is selected the precipitation/evaporation rates must be positive. If net precipitation is selected and the precipitation rate is negative it will act as evaporation.

For the case with precipitation rate varying in time but constant in domain you have to prepare a data file containing the precipitation rate before you set up the hydrodynamic simulation. The data file must be a time series file (dfs0). The data must cover the complete simulation period. The time step of the input data file does not, however, have to be the same as the time step of the hydrodynamic simulation. A linear interpolation will be applied if the time steps differ.

For the case with precipitation rate varying both in time and domain you have to prepare a data file containing the precipitation rate before you set up the hydrodynamic simulation. The file must be a 2D unstructured data file (dfs1) or a 2D grid data file (dfs2). The area in the data file must cover the model area. If a dfs1-file is used piecewise constant interpolation is used to map the data. If a dfs2-file is used bilinear interpolation is used to map the data. The data must cover the complete simulation period. The time step of the input data file does not, however, have to be the same as the time step of the hydrodynamic simulation. A linear interpolation will be applied if the time steps differ.

For the case with evaporation rate varying in time but constant in domain and for the case with evaporation rate varying both in time and domain the data file needed must be prepared in the same way as described above for the precipitation input.

Soft start interval

You can specify a soft start interval during which the precipitation/evaporation rate is increased linearly from 0 to the specified values of the precipitation/evaporation rate. By default the soft start interval is zero (no soft start).

6.13 Infiltration

The effect of infiltration and leakage at the surface zone may be important in cases of flooding scenarios on otherwise dry land.

6.13.1 Infiltration specification

The effect of infiltration can be defined in one of three ways:

- No infiltration



- Net infiltration
- Constant infiltration with capacity

If the user has selected either "Include material zones" or "Include road zones" on the "Material" or "Infrastructure" tab, then you can specify the type of domain input

- Whole domain
- Zone map

When "Zone map" is specified for the type of domain input, it is possible to specify which formulation should be used

- Standard
- Flow dependent

For the standard formulation a constant infiltration rate is used and for the flow dependent formulation the infiltration rate is calculated as function of the water depth.

Net infiltration

When no zone map is specified on the "Domain" page or "Whole domain" is selected for the type of domain input, the net infiltration rate can be specified in two ways:

- Constant in time, varying in domain
- Varying in time and domain

When "Zone map" is specified for the type of domain input and standard formulation is selected you must specify infiltration rate for each zone in the domain.

When "zone map" is specified for the type of domain input and flow dependent formulation is selected you must for each zone specify a discrete curve for the infiltration rate as function of the water depth. The points are taken from the dialog or from a file. The file format is an ascii file with two space separated items for each of the points on separate lines. The first item is the depth and the second item is the infiltration rate. The list of water depth values must have increasing values. There must be at least two points on the curve. Given a water depth at an element in the domain the infiltration rate is calculated using linear interpolation. If the water depth is below the lower limit or above the upper limit, the infiltration is given the value corresponding to the limit.

Constant infiltration with capacity

Using constant infiltration with capacity you must specify the following five infiltration parameters



- Infiltration rate
- Porosity of infiltration zone
- Depth OR Level value describing the extent of the infiltration zone
- Leakage rate (specified as type infiltration)
- Initial water volume in Percentage of capacity (interval: 0-100 [%]) OR as a Water content (interval: 0-porosity[()])

You have to define if the infiltration rate extent should be specified as depth or level and if initial water volume in the infiltration zone should be specified as percentage of the capacity or water content.

When no zone map is specified on the "Domain" page or "Whole domain" is selected for the type of domain input, the infiltration can only be specified as:

- Constant in time, varying in domain

When "Zone map" is specified for the type of domain input and standard formulation is selected you must specify the five infiltration parameters for each zone in the domain.

When "Zone map" is specified for the type of domain input and flow dependent formulation is selected you must for each zone specify a discrete curve for the infiltration rate as function of the water depth. The points are taken from the dialog or from a file. The file format is an ascii file with two space separated items for each of the points on separate lines. The first item is the depth and the second item is the infiltration rate. The list of water depth values must have increasing values. There must be at least two points on the curve. Given a water depth at an element in the domain the infiltration rate is calculated using linear interpolation. If the water depth is below the lower limit or above the upper limit, the infiltration is given the value corresponding to the limit. In addition, you must specify the remaining four infiltration parameters for each zone.

Data

When "Whole domain" is specified for the type of domain input you have to prepare a data file containing the necessary item(s) before you set up the hydrodynamic simulation. The file must be a 2D unstructured data file (dfs1) or a 2D grid data file (dfs2). The area in the data file must cover the model area. If a dfs1-file is used piecewise constant interpolation is used to map the data. If a dfs2-file is used bilinear interpolation is used to map the data. In case the values are varying in time the data must cover the complete simulation period. The time step of the input data file does not, however, have to be the same as the time step of the hydrodynamic simulation. A linear interpolation will be applied if the time steps differ.



6.13.2 General description

The most direct way of including infiltration is to specify the net infiltration rate.

It is however also possible to calculate the net infiltration rate by a simplified model that describes the infiltration from the free surface zone to the unsaturated zone and the leakage from the unsaturated zone to the saturated zone. This way the model can e.g. account for a decreased storage capacity due to previous rainfall events.

The model assumes the following:

- The unsaturated zone is modelled as an infiltration zone with constant porosity over the full depth of the zone.
- The infiltrated volume from the free surface zone and to the unsaturated zone is based on a constant flow rate, $V_{\text{infiltration}} = Q_i \times \Delta t$, where Q_i is the prescribed infiltration rate.
- The leaked volume from the unsaturated zone and to the saturated zone is based on a constant flow rate, $V_{\text{leakage}} = Q_l \times \Delta t$, where Q_l is the prescribed leakage rate.

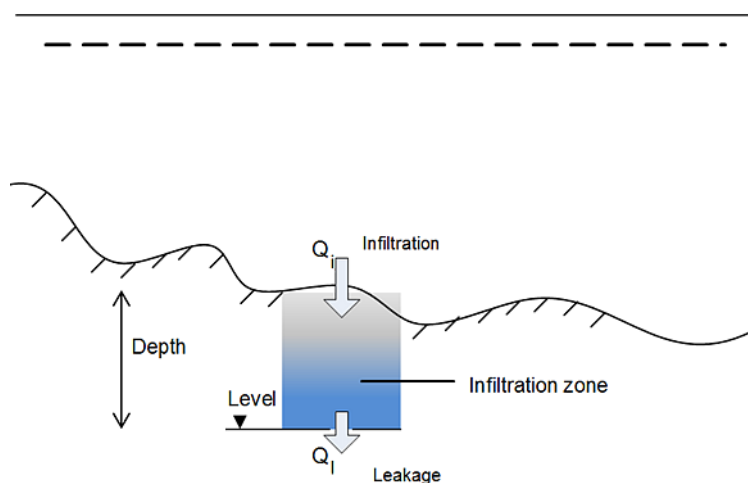

Figure 6.2 Definition of infiltration with storage and leakage:
In the case of net infiltration, $Q_{\text{infiltration}} = Q_{\text{leakage}}$, the model assumes an infinite storage volume in the infiltration zone.



NOTE: The infiltrated flow volume cannot exceed the amount of water available in the free surface water zone nor the difference between the water capacity of the infiltration zone and the actual amount of water stored there. It is possible that the infiltration flow completely drains the free surface zone from water and thus creates a dried-out point in the 2-dimensional horizontal flow calculations. In case the infiltration is described by Constant infiltration



with capacity it is also possible that the infiltration zone becomes fully saturated so infiltration cannot take place (in which case Q_i is set to 0).

6.14 Wave Radiation

The second order stresses due to breaking of short period waves can be included in the simulation. The radiation stresses act as driving forces for the mean flow and can be used to calculate wave induced flow.

If included in the simulation, a data file with the three components of the radiation stress divided by the density of the water, S_{xx} , S_{yy} and S_{xy} , must be specified.

The data file containing the wave radiation stresses can be generated by the wave models MIKE 21 SW.

Data

You have to prepare a data file containing the three components of the wave radiation stress divided by the density of water before you set up the hydrodynamic simulation. The file must be a 2D unstructured data file (dfsu) or a 2D grid data file (dfs2). The area in the data file must cover the model area. If a dfsu-file is used piecewise constant interpolation is used to map the data. If a dfs2-file is used bilinear interpolation is used to map the data. The data must cover the complete simulation period. The time step of the input data file does not, however, have to be the same as the time step of the hydrodynamic simulation. A linear interpolation will be applied if the time steps differ.

Soft start interval

You can specify a soft start interval during which the wave radiation stresses are increased linearly from 0 to the specified values of the radiation stresses in order to avoid shock waves being generated in the model. By default the soft start interval is zero (no soft start).

6.14.1 Recommendations

In order not to generate a “shock” in the computations it is recommended to apply these stresses in combination with a soft-start (warm-up) period.

6.14.2 Remarks and hints

Since the wave radiation stresses describe the average flow over one wave period, the stresses are connected to a certain water depth. Application of the wave radiation stresses in simulations with time varying water depths (e.g. tide and/or storm surges) is possible, but the error introduced by the changes in water depth should be considered.



If the “Flood and Dry” facility is applied, the user should be sure that the wave radiation stresses are well defined in all grid points which will be flooded during the simulation. In general, it is not recommended to use wave radiation stresses together with the “Flood and Dry” facility.

6.15 Sources

The effects of rivers, intakes and outlets from power plants, etc. can be included in the simulation using point sources.

Depending on the choice of property page you can see a geographic view or a list view of the sources.

There are two different methods for specification of the sources. In the list view you can create a new source by clicking on the "New source" button. By selecting a source in the source list and clicking on the "Delete source" you can remove this source. For each source you can specify the name of the source and whether the source should be active or not. The specification of detailed information for each source is made subsequently. From the list view page you can go to the dialog for specification by clicking on the “Go to ..” button or by selecting a source from the source list and clicking on the “Edit source” button.

In the geographic view it is also possible to create a new source by double-clicking a position on the map or by selecting "New source" from the context menu. The name of the source must then be specified and the geographical position of the source can be edited. The additional information for the source is made subsequently.

6.15.1 Source specification

Up to four types of sources can be selected

- Simple source
- Standard source
- Connected source
- Jet

Simple source

For the simple source option only the source contribution to the continuity equation is taken into account. For this option you have to specify only the magnitude of the source. If the magnitude of the source is positive, water is discharged into the ambient water and if the magnitude is negative water is discharged out of the ambient water.



Standard source

For the standard source option both the source contribution to the continuity equation and the momentum equations is taken into account. For this option you have to specify both the magnitude of the source and the velocity by which the water is discharged into the ambient water. Note that the contribution to the momentum equation is only taken into account when the magnitude of the source is positive (water is discharge into the ambient water). It is only possible to specify a contribution to the vertical momentum equation when the Navier-Stokes equations is used for calculating the flow.

Connected source

For the connected source option both the source contribution to the continuity equation and the momentum equations is taken into account. For this option you have to specify the number of the source which the source is connected to .The magnitude of the source is then obtained as the magnitude of the source specified for the connected source, but with opposite sign. You also have to specify the velocity by which the water is discharged into the ambient water. A connected source should be defined after the source it connects to. Note that the contribution to the momentum equation is only taken into account when the magnitude of the source is positive (water is discharge into the ambient water). It is only possible to specify a contribution to the vertical momentum equation when the Navier-Stokes equations is used for calculating the flow.

Jet

For the jet option you have to specify the magnitude of the source. The magnitude of the source has to be positive. If the magnitude is negative the source is treated as a simple source, where water is discharged out of the ambient water. In addition you have to specify the diameter of the jet, the horizontal angle (clockwise from true North) and vertical angle (relative to horizontal, with 90 degree indicating flow toward the surface) and the maximum travel distance of the jet. You can also specify if an upstream approach should be applied for determination of the ambient flow conditions, and in that case you need to specify the minimum upstream distance. For more details on jet source see General description (p. 62).



Note: For a MPI application the communication overhead in connection with jet sources is significant. The inclusion of a large number of jet sources in a simulation can therefore significantly increase the computational time.

Note: When running a simulation in decoupled mode the details of the jet source are not resolved and small deviation in the concentration field can be expected.

Location

You must select the map projection (Longitude/Latitude, UTM, etc.) in which you want to specify the horizontal location of the source point.



You must specify the horizontal coordinates and the vertical position. The vertical position can be specified in four different ways:

- Layer number
- Distance below surface
- Distance above bed
- z-coordinate

When layer number is selected you must specify the number of the layer in which the source should be placed. The layers are numbered 1 at the lowest layer and increasing upwards. In case of a combined sigma-z level mesh some of the bottom layers may be inactive, i.e. the bed layer number may be above 1, see Figure 6.3. In case a source is defined by a layer number which is below the active bed layer, the source will be applied into the active bed layer.

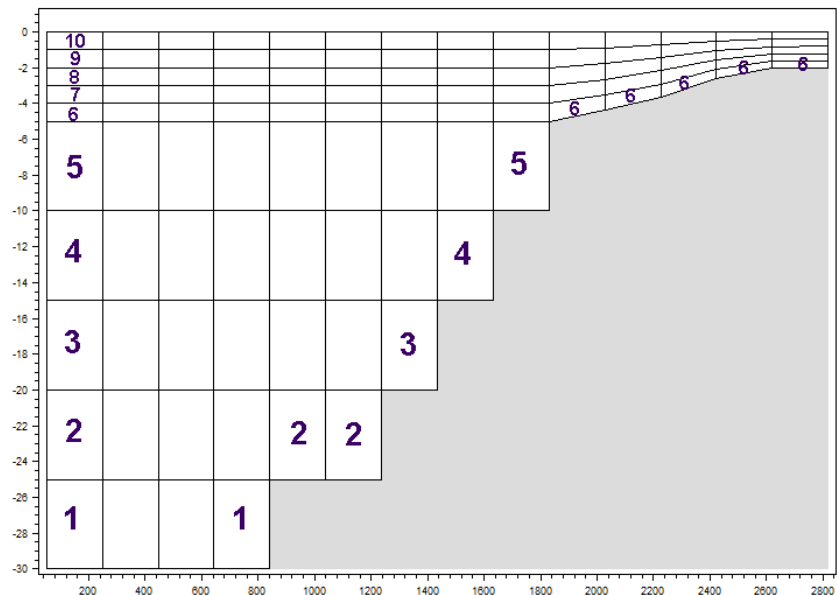

Figure 6.3 Example of layer numbers in source specification for combined sigma-z level mesh

When Distance below surface or Distance above bed is selected you must specify the distance. When z-coordinate is selected the z-coordinate of the source must be specified given in the coordinate system in which the bathymetry is defined and corrected corresponding to the datum shift specified on the domain page.



Data

The format of the source information can be specified as

- Constant in time
- Varying in time

For the case with source information varying in time you have to prepare a data file containing the source information (discharge and/or velocity components) before you set up the hydrodynamic simulation. The data file must be a time series data file (dfs0). The data must cover the complete simulation period. The time step of the input data file does not, however, have to be the same as the time step of the hydrodynamic simulation. A linear interpolation will be applied if the time steps differ.

6.15.2 Output

If output is included you must specify the name of the output file. The file will, for each jet source, contain information of the calculated jet.

The output file contains the following seven items for each jet source:

1. x end position - x-position when the jet/plume becomes passive
2. y end position - y-position when the jet/plume becomes passive
3. z end position - z-position when the jet/plume becomes passive
4. Characteristic width - diameter of the of the jet/plume when it becomes passive
5. Dilution factor - centerline dilution of a tracer or pollutant mass when the jet/plume becomes passive
6. Distance - the distance in horizontal plane from the initial jet/plume position to the end position.
7. Stop code - the stop code is an integer between 1 and 6 correspond to the six stop criteria listed in General description.

6.15.3 General description

The treatment of a jet/plume is based on dynamic coupling of near field integral jet model and the far field hydrodynamic model (MIKE 3 Flow Model FM).

The near field solution is determined using the integral jet model described by Jirka (2004). The jet model determines the steady state solution of the jet/plume by solving conservation equations for flux and momentum, salinity and temperature (if included) as well as the equations for the trajectory of the jet and the equation of state for the centerline density. The steady state solu-



tion at a certain point in time depends on the geometry of the jet efflux, the efflux characteristics (discharge, salinity, temperature) and the calculated ambient flow conditions (surface elevation, current conditions and stratification) from the far field model. The jet model employs an entrainment closure approach that distinguishes between the separate contributions of transverse shear and of azimuthal shear mechanisms. It further contains a quadratic law turbulent drag force mechanism as suggested by a number of recent detailed experimental investigations on the dynamics of transverse jets into cross-flow. When the jet becomes passive it has reached its final position and becomes part of the ambient flow.

The effect of the diluted jet/plume on the far field model is represented by introducing a number of entrainment sinks along the centerline of the predicted jet trajectory and by introducing a source at the final position of the jet trajectory. This approach was proposed by Choi and Lee (2007). For each section in the jet calculation the entrainment of water (the volume flux) is calculated and is then introduced as a sink in the corresponding element in the far field model. If advection-dispersion calculation of temperature and salinity, passive substances, for cohesive or non-cohesive sediment transport or for ecological modelling (MIKE ECO Lab) is included in the simulation the tracer mass flux for the sinks is computed as the volume flux times the local solute concentration. The discharge of water at the final position of the jet is determined as the sum of the total entrained amount of ambient water and the specified effluent discharge. The tracer mass flux at the release point is determined as the sum of the entrainment tracer fluxes and the effluent discharge times the effluent tracer concentration. This approach for representing the jet/plume in the far field model secures conservation of water and tracer mass. A distribution of the released material in the far field model at the final position of the jet is applied to get the right dilution in the far field model. Here a Gaussian distribution is used covering a circular plane corresponding to the final jet radius and perpendicular to the jet trajectory at the final position of the jet. If the jet reaches the surface/bottom level, a uniform distribution is applied covering a circular area over the bed/surface corresponding to the final jet radius.

The determination of the steady state jet solution and the corresponding sink and source information is performed at every hydrodynamic time step.

The ambient flow conditions can be determined either as the local flow conditions at the jet location or as the upstream ambient flow conditions. The upstream option can be used to avoid unrealistic feed-back between the jet solution and the ambient flow in cases with dominant advection effects on the released material from the ambient flow. For the upstream ambient flow condition, the conditions are obtained at a point defined by distance from the jet location in the upstream flow direction. The distance is the maximum of the characteristic length determined from the mesh and a user-specified minimum upstream distance. The characteristic length is here determined as 2.3 times the square root of the local element area at the initial release point. The upstream point for determined the ambient flow conditions is not allowed to



be located on land. In that case the ambient flow conditions are determined at the last upstream point.

In order to determine, when the jet/plume becomes passive and thus a part of the ambient flow, a number of stop criteria are invoked:

1. If the jet reaches the water surface
2. If the jet reaches the bottom
3. If the jet momentum is smaller than or close to the ambient flow induced momentum - the jet excess momentum becomes less than 1% of the ambient flow induced momentum.
(This happens in strong cross flows)
4. If the jet dies out in the stagnant conditions - In the absence of strong ambient flows, if the jet velocity drops below 1 cm/s.
5. If the jet experiences buoyancy reversal twice.
(This happens in stratified environments with large density gradients)
6. If the trajectory of the jet exceeds a maximum travel distance as specified by the user. The travel distance is here defined as the distance in horizontal plane from the initial jet/plume position to the end position.
7. If the jet exhibits strong curvature, such as going into strong opposing ambient flow.
8. If the jet reaches a domain boundary (open or close). It releases in the first set of cells on its trajectory before the boundary.
9. If the jet reaches dried cells. It releases in the last set of wet cells on its trajectory before the dried point.

6.16 Infrastructure

The flux across an infrastructure face - a building face or a road face - is calculated using an empirical formula (see General description) or the flow equations depending on the surface elevation. A building face is defined as a face in the mesh, where the element to one side of the face belongs to a building zone and the element to the other side belongs to a road zone or a material zone. Also, a face where the elements on both sides of the face belong to a building zone and where there is a difference in the level of the buildings, is defined as a building face. A road face is defined as a face in the mesh, where the element to one side of the face belongs to a road zone and the element to the other side belongs to a material zone. The structure level for an infrastructure face is defined as the maximum of the level for the two elements to the right and left of the face. If the surface elevation in both the element to the right and left of the infrastructure face is above the structure level the flow equations is applied and else the empirical formula is applied. If a building zone is excluded from the calculation the flux across the corre-



sponding building faces are always zero and the elements in the zone is treated as dry elements.

Both for buildings and roads you have to specify the critical level difference and the weir coefficient. When the water level gradient across a structure is small, the corresponding gradient of the discharge with respect to the water levels is large. This in turn may result in a very rapid flow response to minor changes in the water level upstream and downstream. As a way of controlling this effect, a critical level difference has been introduced. The critical water level difference defines the water level difference below which the discharge gradients are suppressed. The default setting is 0.01 meter. If a structure shows oscillatory behaviour it is recommended to increase this value slightly.

For each building zone you also have to specify a runoff factor. The factor must be larger or equal to zero and lower or equal to one. This runoff factor is multiplied to the flux across a building face.

6.16.1 General description

The discharge, Q , over a section of the infrastructure corresponding to an element face with the length (width), W , is based on a standard weir expression, reduced according to the Villemonte formula:

$$Q = WC(H_{us} - H_w)^k \left[1 - \left(\frac{H_{ds} - H_w}{H_{us} - H_w} \right)^{0,385} \right] \quad (6.16)$$

where Q is discharge through the structure, W is width, C is weir coefficient, k is the weir exponential coefficient, H_{us} is upstream water level, H_{ds} is downstream water level and H_w is the structure level. The value of the weir exponent is 1.5 and the default value of the weir coefficient is 1.838.

6.17 Structures

The horizontal dimension of structures is usually much smaller than the cell (element) sizes used in the computational grid. Therefore, the effect of structures is modeled by a subgrid technique (the flow past a structure is modelled by considering the upstream and downstream water level). The layers are not considered separately. Six different types of structures can be included in the simulations:

- Weirs
- Culverts
- Dikes
- Gates
- Piers



- Turbines

Furthermore you have the option to include composite structures by combining a weir and one or more culverts.



Note: A structure will only come into effect if placed in an area where water flow would exist without the structure.

6.17.1 Weirs

A weir is defined as a cross (line) section where the total discharge across the cross section is calculated using empirical formulas and distributed along the cross section. In the numerical calculations the cross section is defined as a section of element faces which is treated as an internal discharge boundary (weak formulation).

Depending on the choice of property page you can see a Geographic View or a List View of the weirs.

There are two different methods for specification of the weir. In the List View you can create a new weir clicking on the "New weir" button. By selecting a weir in the Weir list and clicking on the "Delete weir" button you can remove this weir. For each weir you can specify the name of the weir. The specification of detailed information for each weir is made subsequently. From the List View page you can go to the dialog for specification by clicking on the "Go to .." button or by selecting a weir in the Weir list and clicking on "Edit weir" button.

In the Geographic View it is also possible to create a new weir by double-clicking a position on the map. This position will be the first point defining the cross-section for the weir or by selecting "New weir". The name of the weir must then be specified and the geographical position of the weir can then be edited. The additional information for the weir is made subsequently.

Weir specification

The location and geometrical layout of the weirs must be specified.

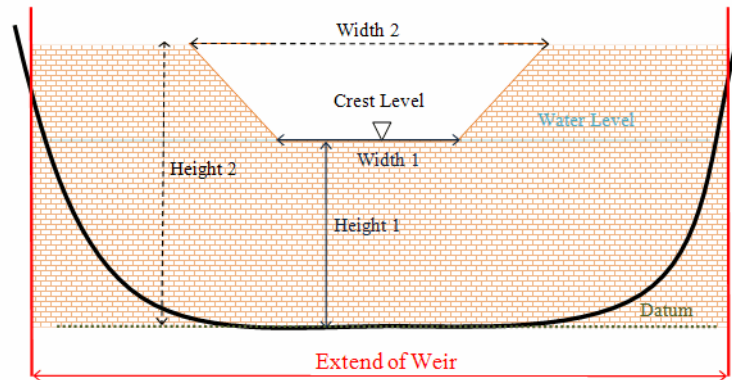

Figure 6.4 Setup definition of contracted weir

Location

Weirs are defined in the domain as a cross (line) section specified as a list of points (a minimum of two points required). The section is composed of a sequence of line segments. The line segments are straight lines between two successive points. The geographical coordinates are taken from the dialog or from an ASCII file. The file format is two space separated floats (real numbers) for the x- and y-coordinate on separate lines for each of the points. The faces defining the line section are listed in the log-file.

You must also select the map projection (Longitude/Latitude, UTM, etc.) in which you want to specify the location of the line section for the weir.

For more information please see *Location of a structure (p. 93)*.

Type

The required formula to be applied for the specific weir-structure is defined in the attributes. A range of formulas are available:

- Broad Crested Weir formula
- Weir formula 1
- Weir formula 2 (Honma formula)

The standard formulations for flow over a broad crested weir are established on the basis of the weir geometry and the specified head loss and calibration coefficients. These formulations assume a hydrostatic pressure distribution on the weir crests. Different algorithms are used for drowned flow and free overflow, with an automatic switching between the two.

Weir formula 1 is based on a standard weir expression, reduced according to the Villemonte formula.

For the Weir formula 2 the discharge is calculated using the Honma formula.



For the Weir formula 1 and Weir formula 2 a number of weir formula parameters must be specified for the geometry and model parameters.

For more information see the scientific documentation.

Valve

Valve regulation of the structure flow can be defined as part of the structure definition.

Four different valve regulation types are available:

- None: No valve regulation applies (flow is not regulated).
- Only Negative Flow
Only flow in negative flow direction is allowed. Valve regulation does not allow flow in positive flow direction and the flow through the structure will be zero in this case.
- Only Positive Flow
Only flow in positive flow direction is allowed. Valve regulation does not allow flow in negative flow direction and the flow through the structure will be zero in this case.
- No Flow
No flow is allowed in the structure. Valve regulation closes completely the structure.

For definition of flow direction please see *Flow direction (p. 94)*.

Alpha zero

When the water level gradient across a structure is small the corresponding gradient of the discharge with respect to the water levels is large. This in turn may result in a very rapid flow response to minor changes in the water level upstream and downstream.

Alpha zero is the water level difference at which the discharge calculation is described by a linear variation. If the water level difference is below this value the discharge gradients are suppressed.

The default setting is 0.01 meter. If a structure shows oscillatory behavior it is recommended to increase this value slightly.

Distribution

The distribution of the calculated discharge along the section of structure faces can be specified in two ways

- Uniform
- Non-uniform

When non-uniform distribution is selected the discharge will be distributed as it would have been in a uniform flow field with the Manning resistance law applied, i.e. is relative to $h^{5/3}$, where h is the depth. This distribution is, in most



cases, a good approximation. This does not apply if there are very large variations over the bathymetry or the geometry. The distribution of the discharge only includes the faces for with the element to the left and the right of the face is a real wet element. In no elements on the downstream side of the structure are real wet elements the distribution is determined based on the upstream information.

A uniform distribution is applied for the vertical distribution.

For Composite structures the distribution for the first structure is applied.

Geometry

The weir geometry defines the geometrical shape of the active flow area of the weir. Geometry is defined as a Level-width relationship, where the Level/Width table defines the Weir shape as a set of corresponding set of levels and flow widths. Values in the levels column must be continuous, increasing values.

Levels are defined relative to the datum (starting from the crest or sill level and up). E.g. for a horizontal weir positioned at invert level -10 m (bed level) and extending 6 m above the bed, the weir could should be defined by $L_0 = -4$ m and $L_1 = 0$ m.

Datum defines an offset which is added to the level column in the level/width table during computation. This is typically used if the weir geometry has been surveyed with respect to a local benchmark.

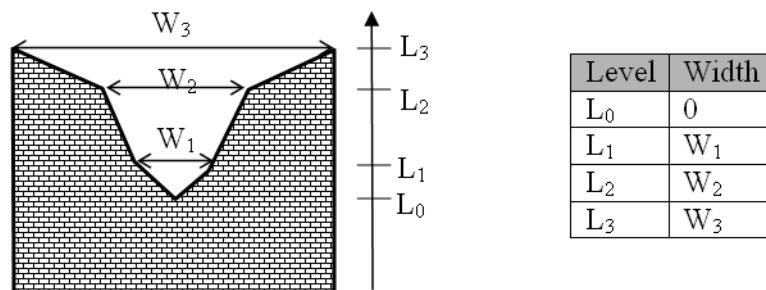

Figure 6.5 Definition sketch of broad crested weir geometry

Weir formula parameters

For Weir formula 1 the width, height and invert level for the weirs must be specified (see Figure 6.6). The invert level is the lowest point in the inlet or outlet section respectively. In addition, a weir coefficient and weir exponent also have to be specified.

For Weir formula 2 the width and crest level for the weirs must be specified (see Figure 6.6). In addition, a weir coefficient has to be specified.

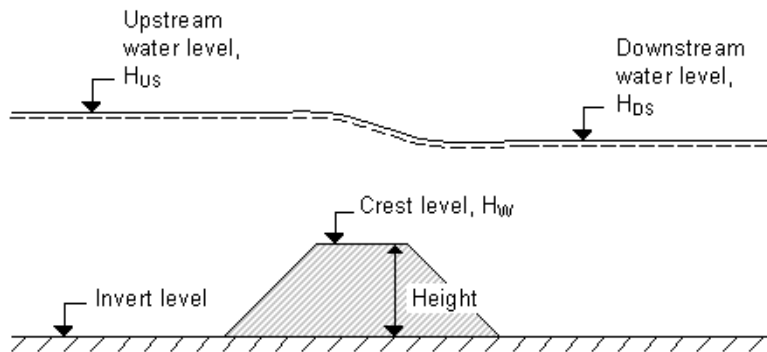

Figure 6.6 Definition sketch for Weir Flow

Head Loss Factors

The factors determining the energy loss occurring for flow through hydraulic structures.

Following head loss factors shall be defined (for positive and negative flow direction):

- Inflow (contraction loss)
- Outflow (expansion loss)
- Free Overflow

Head Loss Factors are applied in structure flow calculation only for broad crested weir and special weir types.

For definition of flow direction please see Flow direction (*p. 94*).

For more information please see the scientific documentation.

6.17.2 Culverts

A short culvert is defined as a cross (line) section where the total discharge across the cross section is calculated using empirical formulas and distributed along the cross section. In the numerical calculations the cross section is defined as a section of element faces which is treated as an internal discharge boundary (weak formulation). A long culvert is defined by a longitudinal line as shown in Figure 6.8 where inlet and outlet locations are defined as two extent lines at the ends of the transversal line. The polyline (line section) in the numerical calculations for each of the two extent lines is defined as a section of element faces. A long culvert is treated as two connected area sources where the total discharge is calculated using empirical formulas. For each of the two extent lines, the area is determined at the area of the elements to the right of the section of element faces.



Depending on the choice of property page you can see a Geographic View or a List View of the culverts.

There are two different methods for specification of the culverts. In the List View you can create a new culvert clicking on the "New culvert" button. By selecting a culvert in the Culvert list and clicking on the "Delete culvert" button you can remove this culvert. For each culvert you can specify the name of the culvert. The specification of detailed information for each culvert is made subsequently. From the List View page you can go to the dialog for specification by clicking on the "Go to .." button or by selecting a culvert in the Culvert list and clicking on "Edit culvert" button.

In the Geographic View it is also possible to create a new culvert by double-clicking a position on the map or by selecting "New culvert" from the context menu. The name of the culvert and the type of the culvert must then be specified. The culvert type can be either a short culvert or a long culvert (see Culvert type). For a long culvert the width of the start line and the end line also have to be specified. The position on the map will be the first point defining the cross-section for a short culvert and the first point for the longitudinal line for a long culvert. The geographical position of the culvert can then be edited. The additional information for the culvert is made subsequently.

Culvert specification

The location and geometrical layout of the culverts must be specified.

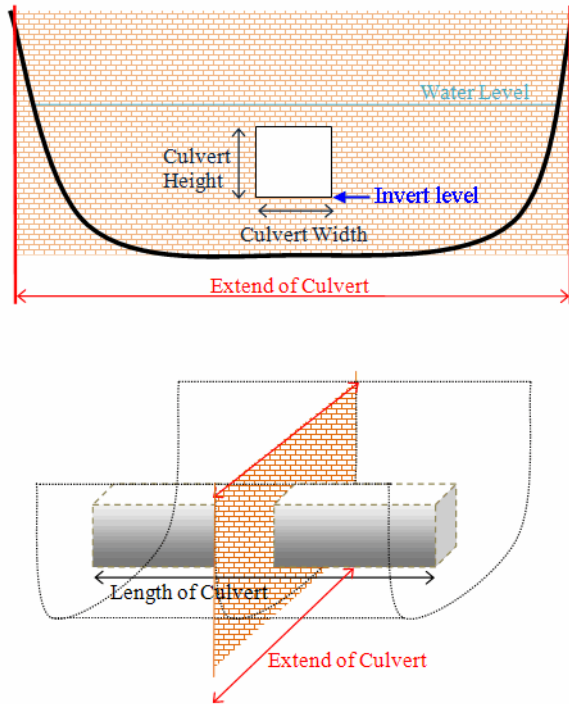

Figure 6.7 Setup definition of culvert

Culvert type

It is possible to use two types of culvert

- Short culvert
- Long culvert

Note: Only short culverts can be used in connection with a Composite structure.

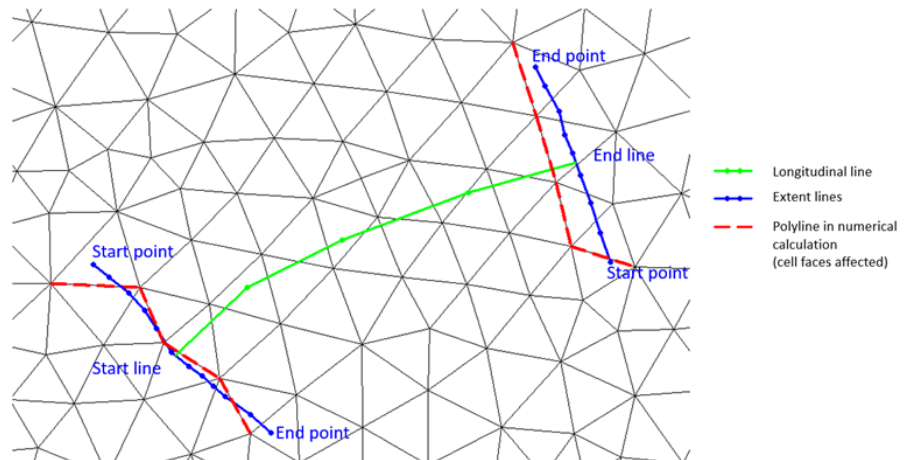

Figure 6.8 Definition sketch for a long culvert

Location

A short culvert is defined in the domain as a cross (line) section specified as a list of points (a minimum of two points required). The section is composed of a sequence of line segments. The line segments are straight lines between two successive points.

For more information please see *Location of a structure (p. 93)*.

The format for specifying a long culvert can be

- From extent lines
- From longitudinal line

When "From extent lines" is selected the two extent lines is defined in the domain as two cross (line) sections both specified as a list of points (a minimum of two points is required). The sections are composed of a sequence of line segments. The line segments are straight lines between two successive points.

When "From longitudinal line" is selected the longitudinal line is defined in the domain as a line section specified as a list of points (a minimum of two points required). The section is composed of a sequence of line segments. The line segments are straight lines between two successive points. In addition, the width of the start line and the end line also has to be specified.

The geographical coordinates for the cross section, the longitudinal line and the extent lines are taken from the dialog or from an ASCII file. The file format is two space separated floats (real numbers) for the x- and y-coordinate on separate lines for each of the points. The faces defining the cross section and the extent lines are listed in the log-file.



You must also select the map projection (Longitude/Latitude, UTM, etc.) in which you want to specify the location of the line sections for the culvert.

Geometry

The culvert geometry defines the geometrical shape of the active flow area of the culvert. The cross sectional geometry of a culvert can be specified as:

- **Rectangular**
The width and height specify the geometry.
- **Circular**
The geometry is specified by the diameter.
- **Irregular Level-Width Table**
The geometry is specified using a level/width table. The Level/Width table defines the Culvert shape as a set of corresponding levels and flow widths. Values in the level column must be increasing.

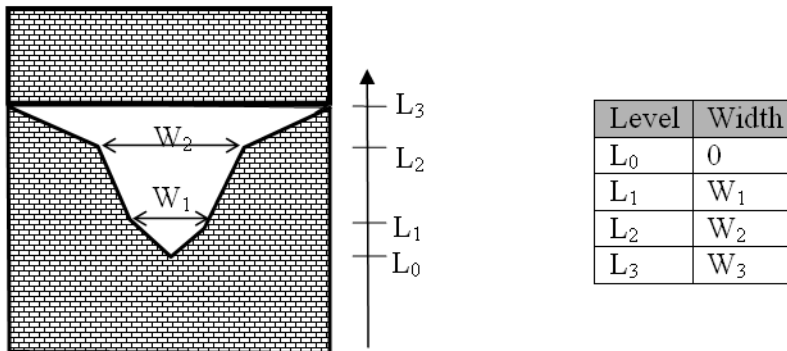

Figure 6.9 Definition sketch for irregular culvert

Attributes

A number of parameters define the culvert characteristics:

- **Upstream Invert**
Invert level to the left of the cross section for a short culvert and at the start line for a long culvert.
- **Downstream Invert**
Invert level to the right of the cross section for a short culvert and at the end line for a long culvert.

NOTE: Upstream and downstream location is not necessarily the inlet and outlet location, respectively.

- **Length**
Length of the culvert.



- Manning's n
Manning's bed resistance number along the culvert (for friction loss contribution). $n = 1/M$ (Manning number)
- No. of Culverts
'No. of Culverts' is a number identifying how many culverts exist at the specific culvert location with identical geometrical definition.

An example; Five identical shaped draining pipes are placed just next to each other in an earth dam, and in order not to make 5 individual culvert definitions - one for each pipe - the 'No. of Culverts' in this case can be defined as 5 and the simulation engine will recognize that 5 culverts of identical shape and size are located here and flow calculations will take this into account accordingly.
- Alpha zero
When the water level gradient across a structure is small the corresponding gradient of the discharge with respect to the water levels is large. This in turn may result in a very rapid flow response to minor changes in the water level upstream and downstream. Alpha zero is the water level difference at which the discharge calculation is described by a linear variation. If the water level difference is below this value the discharge gradients are suppressed. The default setting is 0.01 meter. If a structure shows oscillatory behavior it is recommended to increase this value slightly.

Valve regulation

Valve regulation of the structure flow can be defined as part of the structure definition.

Four different valve regulation types are available:

- None: No valve regulation applies (flow is not regulated).
- Only Positive Flow
Only flow in positive flow direction is allowed. Valve regulation does not allow flow in negative flow direction and the flow through the structure will be zero in this case.
- Only Negative Flow
Only flow in negative flow direction is allowed. Valve regulation does not allow flow in positive flow direction and the flow through the structure will be zero in this case.
- No Flow
No flow is allowed in the structure. Valve regulation closes completely the structure.

For definition of flow direction for a short culvert please see Flow direction (p. 94).



For a long culvert the flow direction is positive when flow is from the start line to the end line (see Figure 6.8).

Section Type

A culvert structure can be defined as either a Closed or an Open section type.

If set to open the culvert will never run full or partially full, therefore only those flow conditions which represent a free water surface are modelled. When the water level is higher than the soffit the hydraulic parameters are calculated based on a section extended vertically upwards with a width equal to that at the soffit. For example, in the case of a rectangular section the height value is essentially redundant as the cross-section will be modeled as an open section of constant width.

In the case of a circular section, this switch is invalid and will be set to closed.

Distribution

The distribution of the calculated total discharge along the section faces can be specified in two ways

- Uniform
- Non-uniform

For a short culvert the discharge is in both cases distributed to the faces for which the element to the left and right of the face are both a wet element and else the discharge is distributed to the faces for which the upstream elements are wet elements. When non-uniform distribution is applied the discharge will be distributed as it would have been in a uniform flow field with the Manning resistance law applied, i.e. relative to $h^{5/3}$, where h is the total water depth.

For a long culvert the discharge is in both cases distributed to the faces for which the element to the right of the extent line is a wet element. If no elements are wet the discharge is distributed uniformly to all faces in the section. When non-uniform distribution is applied the same approach as for short culverts is used. The non-uniform distribution is, in most cases, a good approximation. This does not apply if there are very large variations over the bathymetry or the geometry.

A uniform distribution is applied for the vertical distribution.

For Composite structures the distribution for the first structure is applied.

Momentum

For a long culvert it is possible to include or exclude a contribution to the momentum equations at the outlet location. This contribution is estimated as the discharge multiplied by a velocity. Here the magnitude of the velocity is calculated as the discharge divided by the local total water depth. The direction used for the two extent lines is the direction of the first and last segment of the transversal polyline. If the transversal polyline only contains one seg-



ment (two points), the direction is determined as the direction perpendicular to the line given by the first and last point of the extent line.

Head Loss Factors

The factors determining the energy loss occurring for flow through hydraulic structures.

Following head loss factors shall be defined (for positive and negative flow directions):

- Inflow (contraction loss)
- Outflow (expansion loss)
- Free Overflow
- Bends

For definition of flow direction for a short culvert please see [Flow direction \(p. 94\)](#).

For a long culvert the flow direction is positive when flow is from the start line to the end line (see [Figure 6.8](#)).

For more information please see [Scientific Documentation](#).

6.17.3 Dikes

Depending on the choice of property page you can see a Geographic View or a List View of the dikes.

There are two different methods for specification of the dike. In the List View you can create a new dike clicking on the "New line" button. By selecting a dike in the Dike list and clicking on the "Delete line" button you can remove this dike. For each dike you can specify the name of the dike and whether the dike should be active or not. The specification of detailed information for each dike is made subsequently. From the List View page you can navigate to the dialog for specification by clicking on the "Go to .." button.

In the Geographic View it is also possible to create a new dike by selecting "Add New line" from the context menu. Click once to add a point and twice to add the end point of the dike. You may edit the individual dike by selecting and moving the specified points (point, click and drag) or using the functionalities from the context menu (point, right-click). The additional information for the dike is entered subsequently.

Dike specification

The data for the dike and the location and geometry of the dike must be specified.



The discharge over the dike can be specified in three different ways

- Empirical formula
- Specify the overtopping discharge
- Calculate the overtopping discharge from a user-specified table

Empirical formula

When "Empirical formula" is selected you have to specify the critical level difference and the weir coefficient.

When the water level gradient across a structure is small, the corresponding gradient of the discharge with respect to the water levels is large. This in turn may result in a very rapid flow response to minor changes in the water level upstream and downstream. As a way of controlling this effect, a critical level difference has been introduced. The critical water level difference defines the water level difference below which the discharge gradients are suppressed. The default setting is 0.01 meter. If a structure shows oscillatory behavior it is recommended to increase this value slightly.

Specify the overtopping of discharge

When "Specify the overtopping discharge" is selected the discharge can be specified as

- Constant
- Varying in time and constant along curve
- Varying in time and varying along curve

When "Constant" is selected you have to specify the constant discharge and the start time and end time for which the discharge should be applied.

When "Varying in time and constant along curve" is specified you have to prepare a data file containing the discharge before you set up the simulation. The file must be a dfs0 file. The data must cover the complete simulation period when "Varying in time and varying along curve" is specified for the format. The time step of the input data file does not, however, have to be the same as the time step of the hydrodynamic simulation. A linear interpolation will be applied if the time steps differ.

When "Varying in time and varying along curve" is specified you have to prepare a data file containing the discharge before you set up the simulation. The file must be a dfs1 file, where the number of grid points corresponds to the number of points, which is used to define the location of the dike. The data must cover the complete simulation period when "Varying in time and varying along curve" is specified for the format. The time step of the input data file does not, however, have to be the same as the time step of the hydrodynamic simulation. A linear interpolation will be applied if the time steps differ.



The discharge is positive when the flow occurs from the left of the dike to the right of the dike when positioned at the first point and looking forward along the line section, see Figure 6.18.

Calculate the overtopping discharge from a user-specified table

When "Calculate the overtopping discharge from a user-specified table" is selected, you must enter the file name for the file containing the discharge table. This table should contain the discharge ($\text{m}^3/\text{s}/\text{m}$) as function of the discrete values of the freeboard (m), the significant wave period (m) and the peak wave period (s). For the description of the format of the file see ASCII format for the discharge table (p. 79). The freeboard is defined as the crest level minus the surface elevation. The surface elevation, the significant wave height and the peak wave period are determined as the values to the left of the dike when positioned at the first point and looking forward along the cross-section line.

The discharge is positive when the flow occurs from the left of the dike to the right of the dike when positioned at the first point and looking forward along the line section, see Figure 6.18.

ASCII format for the discharge table

This is a general format which can be generated by most spread sheets or text editors.

The first part of the ASCII file must contains the header Information. The header information consists of three lines each with three space separated items:

- The first line contains the number of discrete freeboards, nf , the minimum freeboard, f_{min} , and the maximum freeboard, f_{max} .
- The second line contains the number of discrete significant wave heights, nh , the minimum significant wave height, h_{min} , and the maximum significant wave height, h_{max} .
- The third line contains the number of discrete peak wave periods, nt , the minimum peak wave period, t_{min} , and the maximum peak wave period, t_{max} .

Data follows after the header information. The data consist of the discharge ($\text{m}^3/\text{s}/\text{m}$), $q_{i,j,k}$, as function of discrete values of the freeboard, f_i , significant wave height, h_j , and peak wave period, t_k .

$$\begin{aligned}
 f_i &= f_{min} + (i-1) \frac{f_{max} - f_{min}}{nf - 1} & i &= 1, nf \\
 h_j &= h_{min} + (j-1) \frac{h_{max} - h_{min}}{nh - 1} & j &= 1, nh \\
 t_k &= t_{min} + (k-1) \frac{t_{max} - t_{min}}{nt - 1} & k &= 1, nt
 \end{aligned} \tag{6.17}$$



The structure of the table can be expressed as follows:

```
nf  $f_{\min}$   $f_{\max}$ 
nh  $h_{\min}$   $h_{\max}$ 
nt  $t_{\min}$   $t_{\max}$ 
q1,1,1 q2,1,1 q3,1,1 ... qnf,1,1
q1,2,1 q2,2,1 q3,2,1 ... qnf,2,1
...
q1,nh,1 q2,nh,1 q3,nh,1 ... qnf,nh,1
q1,1,2 q2,1,2 q3,1,2 ... qnf,1,2
q1,2,2 q2,2,2 q3,2,2 ... qnf,2,2
...
q1,nh,2 q2,nh,2 q3,nh,2 ... qnf,nh,2
...
q1,1,nt q2,1,nt q3,1,nt ... qnf,1,nt
q1,2,nt q2,2,nt q3,2,nt ... qnf,2,nt
...
q1,nh,nt q2,nh,1 q3,nh,nt ... qnf,nh,nt
```

Location and geometry

The location in the horizontal domain of a structure may be given by a number of geo-referenced points which together make up a polyline. The poly-line defines the width of the structure perpendicular to the flow direction. A minimum of two points is required. The polyline is composed of a sequence of line segments. The line segments are straight lines between two successive points. The polyline (cross section) in the numerical calculations is defined as a section of element faces. The face is included in the section when the line between the two element centers of the faces crosses one of the line segments. If two faces in a triangular element are part of the same face section, the face section is corrected so that these two faces are excluded from the face section and instead the third face in the triangle is applied.

For more information please see [Location of a structure \(p. 93\)](#).

The crest level of the structure can be specified as:

- Constant
- Varying in domain

When Constant is specified you have to specify the constant crest level. The geographical coordinates and the crest level, when "Varying in domain" is selected for the crest level, are taken from the dialog or from an ASCII file. The file format is three space separated floats (real numbers) for the x- and y-coordinate and the crest level on separate lines for each of the points. The faces defining the line section are listed in the log-file.

You must also select the map projection (Longitude/Latitude, UTM, etc.) in which you want to specify the location of the line section for the structure.



Crest level correction

It is possible to specify a correction of the crest level. The format for the crest level correction can be specified as:

- Constant
- Constant in time and varying along curve
- Varying in time and varying along curve

When "Constant in time and varying along curve" and "Varying in time and varying along curve" is specified you have to prepare a data file containing crest level correction before you set up the simulation. The file must be a dfs1 file, where the number of grid points corresponds to the number of points, which is used to define the location of the dike. The data must cover the complete simulation period when "Varying in time and varying along curve" is specified for the format. The time step of the input data file does not, however, have to be the same as the time step of the hydrodynamic simulation. A linear interpolation will be applied if the time steps differ.

General description

When the empirical formulation is used the discharge, Q , over a section of the dike corresponding to an element face with the length (width), W , is based on a standard weir expression, reduced according to the Villemonte formula:

$$Q = WC(H_{us} - H_w)^k \left[1 - \left(\frac{H_{ds} - H_w}{H_{us} - H_w} \right)^{0,385} \right] \quad (6.18)$$

where Q is discharge through the structure, W is width, C is weir coefficient, k is the weir exponential coefficient, H_{us} is upstream water level, H_{ds} is downstream water level and H_w is weir level taken with respect to the global datum (see Figure 6.10). The value of the weir exponent is 1.5 and the default value of the weir coefficient is 1.838.

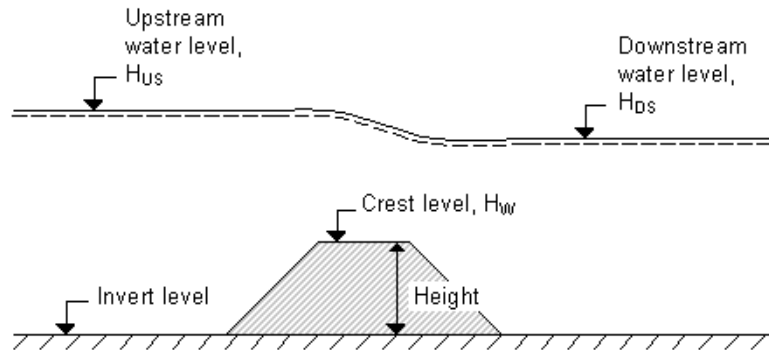

Figure 6.10 Definition sketch for Dike Flow

Note: The crest level applied in the calculations is defined as the highest of three values: the user-specified crest level, the ground level in upstream element or the ground level in downstream element.

6.17.4 Gates

Depending on the choice of property page you can see a Geographic View or a List View of the gates.

There are two different methods for specification of the gates. In the List View you can create a new gate clicking on the "New gate" button. By selecting a gate in the Gate list and clicking on the "Delete gate" button you can remove this gate. For each gate you can specify the name of the gate and whether the gate should be active or not. The specification of detailed information for each gate is made subsequently. From the List View page you can navigate to the dialog for specification by clicking on the "Go to .." button or by selecting a gate in the Gate list and clicking on "Edit gate" button.

In the Geographic View it is also possible to create a new gate by double-clicking on a position on the map or by selecting "New gate" from the context menu. This position will be the first point defining the line-section for the gate. The name of the gate must then be specified and the geographical position of the gate can then be edited. The additional information for the gate is entered subsequently.

Gate specification

The location of the gate and the control information for operation of the gate is specified.

Location

Gates are defined in the domain as a line section specified as list of points (a minimum of two points is required). The section is composed of the sequence



of line segments. The line segments are straight lines between two successive points. The cross section in the numerical calculations is defined as a section of the nearest element faces. The face is included in the section when the line between the two element centers of the faces crosses one of the line segments. The geographical coordinates are taken from the dialog or from an ASCII file. The file format is two space separated floats (real numbers) for the x- and y-coordinate on separate lines for each of the points. The faces defining the line section are listed in the log-file.

You must also select the map projection (Longitude/Latitude, UTM, etc.) in which you want to specify the location of the line section for the gate.

For more information please see *Location of a structure (p. 93)*.

Gate Data

You must define the geometry of the gate along with the operation type.

The geometry can be described in two ways:

- Full water column
- Subset of column

If a subset of the column is requested you have to define the top level and bottom level in the water column set that is to be affected by the gate.

NOTE: The water level at the gate is derived by the average water level of the adjacent elements as shown in Figure 6.11.

The operation of the gate can be defined in three ways:

- User defined
- Water level control
- Water level difference control

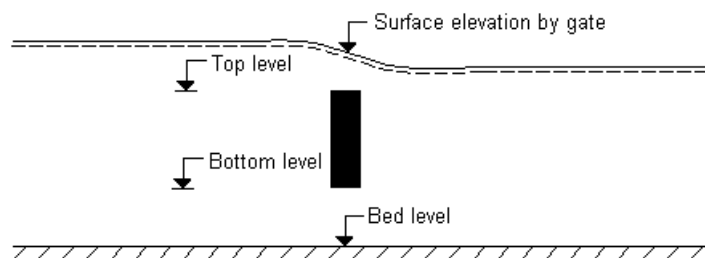

Figure 6.11 Definition sketch for Gate Flow



User defined

In case the operation is to be user defined the gate is controlled by a factor. If the factor is 1 the gate is open and if the factor is 0 the gate is closed. When the factor is in the interval between 0 and 1 the gate is partly closed. The format of the control factor can be specified as:

- Constant in time
- Varying in time

For the case with the control factor varying in time you have to prepare a data file containing the control factor before you set up the hydrodynamic simulation. The data file must be a time series data file (dfs0). The data must cover the complete simulation period. The time step of the input data file does not, however, have to be the same as the time step of the hydrodynamic simulation. A linear interpolation will be applied if the time steps differ.

Water level control

In case the operation is to be controlled by surface elevation, you have to define the location of the control point from where the controlling water level is extracted.

The gate is controlled based on the given control values. Two modes of operation are possible.

If you have specified a Close level greater than the Open level then:

When the simulated water level at the control point becomes lower than the value of the defined open level, the gate will open within the duration of the defined open interval. When the simulated water level at the control point becomes higher than the value of the defined close level, the gate will close within the duration of the defined close interval. Initially the gate is open.

If you have specified a Close level lower than or equal to the Open level then:

When the simulated water level at the control point becomes higher than the value of the defined open level, the gate will open within the duration of the defined open interval. When the simulated water level at the control point becomes lower than the value of the defined close level, the gate will close within the duration of the defined close interval. Initially the gate is closed.

If after the initial opening, you do not want the gate to ever close, specify a close level which can never be reached (say a level lower than the bathymetry).

An instant internal control factor will be applied using linear interpolation during the open/close interval.



Water level difference control

In case the operation is to be controlled by surface level difference you have to define the locations of the two control points from where the controlling water levels are extracted. The water level difference is regarded as positive if the water level in control point 1 is higher than the water level in control point 2.

The gate is controlled based on the given control values. When the simulated water level difference becomes lower than the value of the defined open level, the gate will open within the duration of the defined open interval. When the simulated water level difference becomes larger than the value of the defined close level, the gate will close within the duration of the defined close interval. Initially, the gate is closed.

An instant internal control factor will be applied using linear interpolation during the open/close interval.

General description

The location of the gate is defined as a section of element faces. At a gate face with the area, ΔA , the normal flux is calculated as the sum of the normal flux for a solid wall, where the area is determined as $(1-c)*\Delta A$, and the normal flux for a standard wet face, where the area is $c*\Delta A$. Here, c is a weighting factor with a value between 0 and 1, where 0 correspond to a closed gate and 1 correspond to an open gate. If the gate is defined as the full water column, c is equal to the user-defined gate control factor. If the gate geometry is defined as a subset of the water column the vertical location of the gate is defined by the top level, z_{top} , and bottom level of the gate, z_{bottom} , (see Figure 6.11). In this case c is equal to the user-defined gate control factor multiplied by the fraction, f , corresponding to the fraction of the element face, which is blocked by the gate.

6.17.5 Piers

The effect of bridge piers is modelled as sub-grid structures using a simple drag-law to capture the increasing resistance imposed by the piers as the flow speed increases.

Depending on the choice of property page you can see a Geographic View or a List View of the piers.

There are two different methods for specification of the piers. In the List View you can create a new pier by clicking on the "New pier" button. By selecting a pier in the Pier list and clicking on the "Delete pier" button you can remove this pier. For each pier you can specify the name of the pier and whether the pier should be active or not. The specification of detailed information for each pier is made subsequently. From the List View page you can navigate to the dialog for specification by clicking on the "Go to .." button or by selecting a pier in the Pier list and clicking on the "Edit pier" button.



In the Geographic View it is also possible to create a new pier by double-clicking on a position on the map or by selecting "New pier" from the context menu. The name of the pier must then be specified and the geographical position of the pier can then be edited. The additional information for the pier is made subsequently.

Pier specification

The location and geometrical layout of the piers must be specified.

Location

You specify the horizontal coordinates in which the pier should be placed.

You must also select the map projection (Longitude/Latitude, UTM, etc.) in which you want to specify the horizontal location of the pier point.

Pier Data

First you specify the angle of the pier, the streamline factor and the number of vertical pier sections. Then you specify the geometry.

The angle is measured from projection north to the alignment, positive clockwise and in degrees, see Figure 6.12. Note that projection north is not necessarily the same as geographical north.

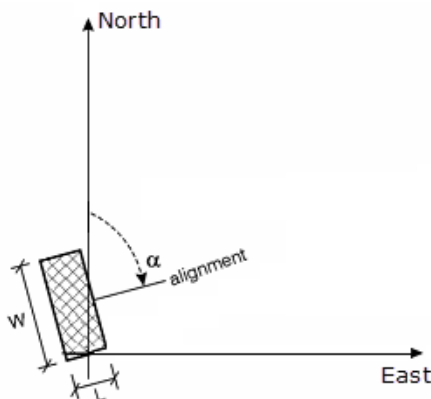

W : width of pier section
L : length of pier section
 α : angle between projection north and alignment

Figure 6.12 Definition of pier angle

The streamline factor is a factor that is multiplied on the total drag force to take into account the increased flow velocity due to the blocking of piers. A typical value is 1.02.

The number of sections means the number of pier segments, i.e. the number of vertical sections with different geometrical layout.



Geometry

Additionally, you specify the geometry for each section. You have to specify the type of pier. The type can be one of three:

- Circular
- Rectangular
- Elliptical

For each section you specify a number of parameters depending on the type of section. For a circular section the height and the width (diameter) must also be specified. For a rectangular section the height, the width, the length and the radius of the corners must be specified. Finally, for an elliptical section the height, the width and the length must be specified. The sections are ordered so that the first section is at the top of the pier structure and the last section is at the bottom of the pier structure (at the sea bed), see Figure 6.13.

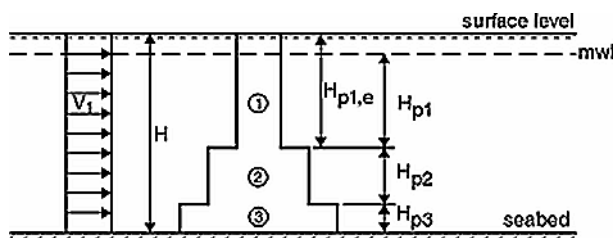

Example: Effective height for pier section:

$$H_{p1e} = \max \{ [H - (H_{p2} + H_{p3})], 0 \}$$

$$H_{p2e} = \max \{ [H - (H_{p1e} + H_{p3})], 0 \}$$

$$H_{p3e} = \min \{ H_{p3}, H \}$$

Figure 6.13 Definition of pier sections

General description

The effect on the flow due to the piers is modeled by calculating the current induced drag force on each individual pier.

The effective drag force, F , is determined from

$$F = \frac{1}{2} \rho_w \gamma C_D A_e V^2 \quad (6.19)$$

where ρ_w is the density of water, γ is the streamline factor, C_D is the drag coefficient, A_e is the effective area of the pier exposed to current and V is the current speed. The sign of F is such that a positive force acts against the current direction.



6.17.6 Turbines

The effect of tidal turbines is modelled as sub-grid structures using a simple drag-law to capture the increasing resistance imposed by the turbine blades as the flow speed increases. Turbines are assumed always to have their axis aligned with the flow direction.

Depending on the choice of property page you can see a Geographic View or a list view of the turbines. On the property page output it is possible to specify if turbine information should be written to an output file.

There are two different methods for specification of the turbines. In the List View you can create a new turbine by clicking on the "New turbine" button. By selecting a turbine in the Turbine list and clicking on the "Delete turbine" you can remove this turbine. For each turbine you can specify the name of the turbine and whether the turbine should be active or not. The specification of detailed information for each turbine is made subsequently. From the List View page you can navigate to the dialog for specification by clicking on the "Go to .." button or by selecting a turbine in the Turbine list and clicking on the "Edit turbine" button.

In the Geographic View it is also possible to create a new turbine by double-clicking a position on the map or by selecting "New turbine" from the context menu. The name of the turbine must then be specified and the geographical position of the turbine can then be edited. The additional information for the turbine is made subsequently.

Turbine specification

The location of the turbine and the turbine data is specified.

Location

You specify the horizontal coordinates in which the turbine should be placed.

You must also select the map projection (Longitude/Latitude, UTM, etc.) in which you want to specify the horizontal location of the turbine point.

Turbine Data

You must specify the diameter of the turbine and the z-coordinate of the centroid of the turbine.

The resistance imposed by the turbine blades can be specified in one of two ways:

- Fixed drag coefficient
- Tabulated drag and lift coefficient

When "Fixed drag coefficient" is selected, the turbine is assumed to have the axis aligned with the flow direction. Hence no lift force is calculated.



When “Tabulated drag and lift coefficient” is selected you must also specify the orientation of the turbine, $\theta_{\text{alignment}}$. The orientation is measured from projection north to the alignment, positive clockwise in degrees, see Figure 6.14. Note that the projection north is not necessarily the same as geographic north.

You must also specify if current correction should be applied (see General description (p. 90)).

It is also necessary to specify a correction factor. The correction factor is multiplied on the drag and lift.

The format of the correction factor can be specified as:

- Constant in time
- Varying in time

For the case with correction factor varying in time you have to prepare a data file containing the correction factor before you set up the hydrodynamic simulation. The data file must be a time series data file (dfs0). The data must cover the complete simulation period. The time step of the input data file does not, however, have to be the same as the time step of the hydrodynamic simulation. A linear interpolation will be applied if the time steps differ.

Fixed drag coefficient

In case of a fixed drag coefficient you specify a constant value.

Tabulated drag and lift coefficient

In case of tabulated values you have to specify the drag and lift coefficients as a function of current speed, V , and direction, θ . The definition of θ is shown in Figure 6.14.

Direction and speed

You have to specify the extent and range of the grid defining the tabulated speed and current values.

Drag coefficient

You have to specify the drag coefficient for each table value in the grid.

Lift coefficient

You have to specify the lift coefficient for each table value in the grid.

Output

If output is included you must specify the name of the output file. The file will, for each turbine, contain the drag and lift force and the average current speed and current direction used in the calculation of the drag force.



General description

The effect to the flow due to the turbines is modeled by calculating the current induced drag and lift force on each individual layer.

The effective drag force, F_D and lift force, F_L , are determined from

$$\begin{aligned} F_D &= \frac{1}{2} \rho_w \alpha C_D A_e V_0^2 \\ F_L &= \frac{1}{2} \rho_w \alpha C_L A_e V_0^2 \end{aligned} \quad (6.20)$$

where ρ_w is the density of water, α is a correction factor, C_D is the drag coefficient, C_L is the lift coefficient, A_e is the effective area of the turbine exposed to current and V_0 is the upstream current speed.

For three-dimensional calculations the current speed used to determine the force is the average current speed over the water column covered by the turbine and the shear stress is equally distributed over water column covered by the turbine.

When no current correction is applied the upstream current velocity is approximated by the local velocity, V_{local} . The local velocity is the velocity in the cell, where the turbine is located. When current correction is included the upstream current speed is approximated by

$$\frac{2}{1 + \sqrt{1 - \gamma}} V_{\text{local}} \quad (6.21)$$

where $\gamma = \alpha C_D A_e / h \Delta s$. Here h is the water depth and Δs is grid distance. When the drag coefficient is specified as a function of the upstream current speed the corrected current speed is determined by iteration. The grid distance is determined as the width perpendicular to the flow direction of the element, where the turbine is located. For more detail see (Kramer et al. (2014)).



Definition of angles in calculation

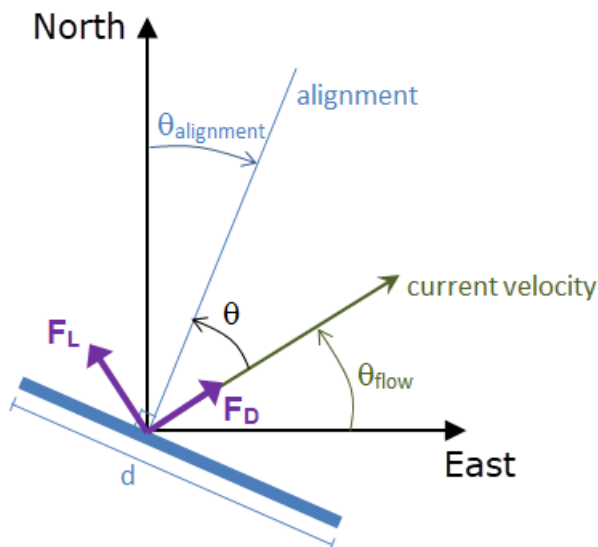

d : diameter of turbine

θ_{flow} : current direction

$\theta_{\text{alignment}}$: angle between projection north and alignment

θ : angle between alignment and flow

Figure 6.14 Definition of turbine angles

6.17.7 Composite structures

Composite structures can be defined by combining a weir and/or one or more culverts. A composite structure can only be composed of a combination of Weirs and/or Culverts.

An example of a composite structure could be a bridge with multiple waterways. Such a structure can be described by a number of culverts, each defining an individual waterway. Additionally, for a potential bridge deck overtopping a weir can be included to describe such overflow.

A set of structures forming a composite structure are recognized by the program from the location definitions. **Locations must be completely identical for all the structures forming the composite structure.** That is, the table of coordinates defining the structure locations must be exactly identical (number of coordinates and coordinate values) for all structures defined.

Examples of composite structures are given below.

Example 1 - A wide weir with a small opening

Consider a weir as illustrated in Figure 6.15.

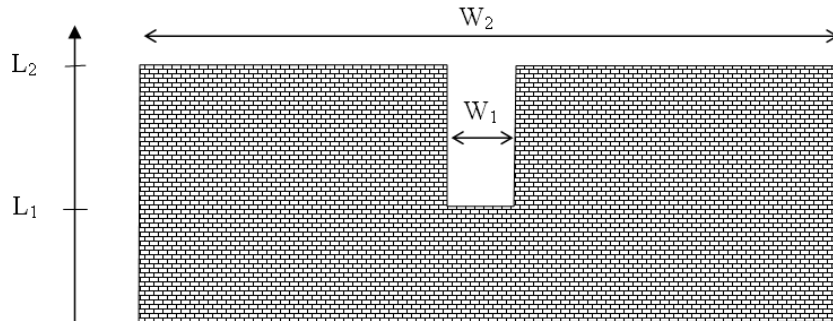

Figure 6.15 Wide weir with a small opening

There are a number of possibilities when modeling this in MIKE 21:

1. One weir
2. Two weirs with width W_1 and width $(W_2 - W_1)$, respectively
3. Three weirs with widths W_1 and two with width $(W_2 - W_1)/2$, respectively

Using the first approach is only appropriate if the weir can be contained within a single grid cell. The second approach may be used if the weir spans multiple cells, keeping in mind that the flow over the highest crest (L_2) is uniformly distributed over all the affected cells. The third approach will give the best representation of the flow. Note that the location needs to be defined for each of the segments for case 2 and 3.

Example 2 - A wide weir with multiple culverts

Consider a structure as illustrated in Figure 6.16.

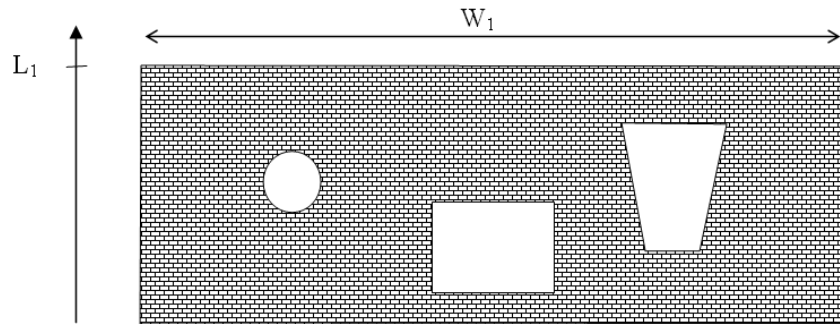

Figure 6.16 Wide weir with multiple culverts

The composite structure should be implemented as four separate structures:

1. A weir with a constant crest level L_1 and a location defined by the full extent of the weir
2. A circular culvert and a location defined by the full extent of the weir
3. A rectangular culvert and a location defined by the full extent of the weir
4. A irregular culvert described by a level/width table and a location defined by the full extent of the weir

Note that the location needs to be defined for each of the four structure components separately. The location line should correspond to the maximum width of the structure component while still obeying the minimum requirement with respect to intersecting a line segments connecting cell centres.

6.17.8 Remarks and hints

Location of a structure

Weirs, culverts, dikes and gates are defined as line sections. The location in the domain of a line section is given by a number of geo-referenced points which together make up a polyline. This is illustrated in Figure 5.1. The polyline defines the width of the cross section perpendicular to the flow direction. A minimum of two points is required. The polyline is composed of a sequence of line segments. The line segments are straight lines between two successive points. The polyline (line section) in the numerical calculations is defined as a section of element faces. The face is included in the section when the line between the two element centers of the faces crosses one of the line segments. If two faces in a triangular element are part of the same face section, the face section is corrected so that these two faces are excluded from the face section and instead the third face in the triangle is applied. The left and right side of the of the line section is defined by positioning at the start point and looking forward along the cross-section.

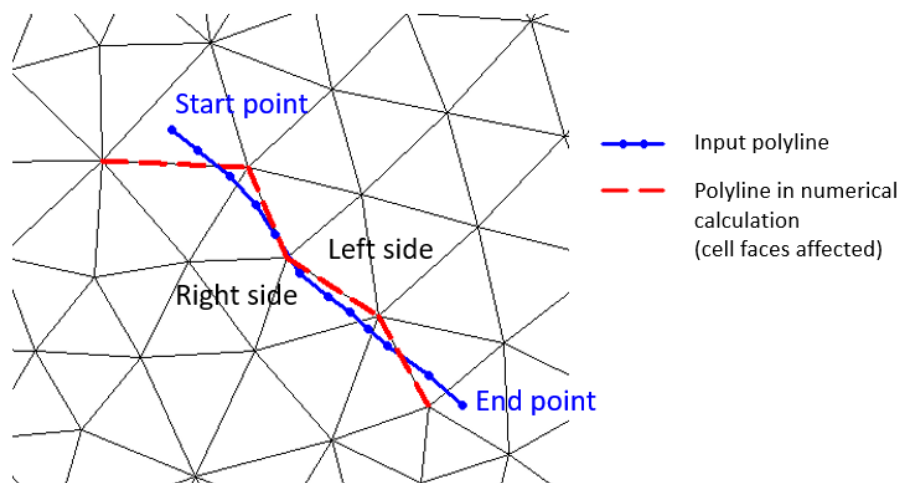

Figure 6.17 The location of a line section

Flow direction

Positive and Negative flow directions as referred to in Valve and Head loss coefficient definitions follows the definition as presented in Figure 6.18. The flow direction is positive when the flow occurs from the right of the line structure to the left positioned at the first point and looking forward along the line section.

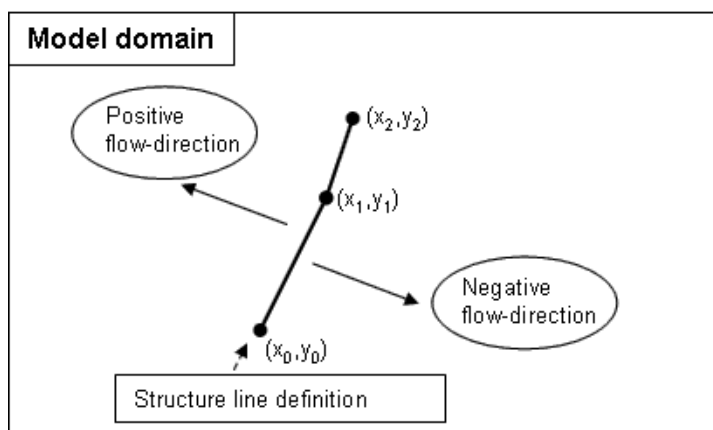

Figure 6.18 Positive and Negative flow direction definition for weirs and culverts

6.18 Waves

If you have defined a dike and calculate the overtopping discharge from a user-specified table (see page 78) or if you have defined the bed resistance



by Wave induced bed resistance (see page 46) you can define the related waves to be used in your calculations as

- No waves
- Wave field

No waves

If you choose no waves, the overtopping discharge is derived assuming the minimum significant wave height, h_{min} , and minimum peak wave period, t_{min} , defined in the user specified table.

The wave induced bed resistance cannot be applied without specifying any wave data.

Wave field

If you choose wave field you have four options to describe the waves

- Constant
- Varying in time, constant in domain
- Constant in time, varying in domain
- Varying in time and domain

For all options you must specify the wave height, wave period and the angle to true north.

You must select to specify the wave height as the RMS wave height **or** the significant wave height.

You must select to specify the wave period as the peak wave period **or** the mean wave period.

For the case of varying waves, you have to prepare a data file containing the wave properties (mean heights, periods and angles to true north) before you set up the hydrodynamic simulation.

Data

Constant

For the case of constant waves the waves will be sinusoidal with no directional spreading. You must specify the wave height, wave period and the angle to true north. These values will be set for the entire domain in all time steps of the simulation.

Varying in time, constant in domain

For this case you have to prepare a time series file (dfs0) that contains the wave properties. The values in the data file will be set for the entire domain



for each time step in the simulation. If the time step in the file is not equal to that of the simulation, the program will interpolate (see Figure 6.19).

Constant in time, varying in domain

For this case you have to prepare a 2D unstructured data file (dfs_u) or a 2D grid data file (dfs2) that contains the wave properties. The area in the data file must cover the model area. If a dfs_u-file is used, a piecewise constant interpolation is used to map the data. If a dfs2-file is used, a bilinear interpolation is used to map the data. The first time step of the file will be used in all time steps of the simulation.

Varying in time and domain

For this case you have to prepare a 2D unstructured data file (dfs_u) or a 2D grid data file (dfs2) that contains the wave properties. The area in the data file must cover the model area. If a dfs_u-file is used, a piecewise constant interpolation is used to map the data. If a dfs2-file is used, a bilinear interpolation is used to map the data. The program will interpolate if the time step is not equal to that of the simulation (see Figure 6.19).

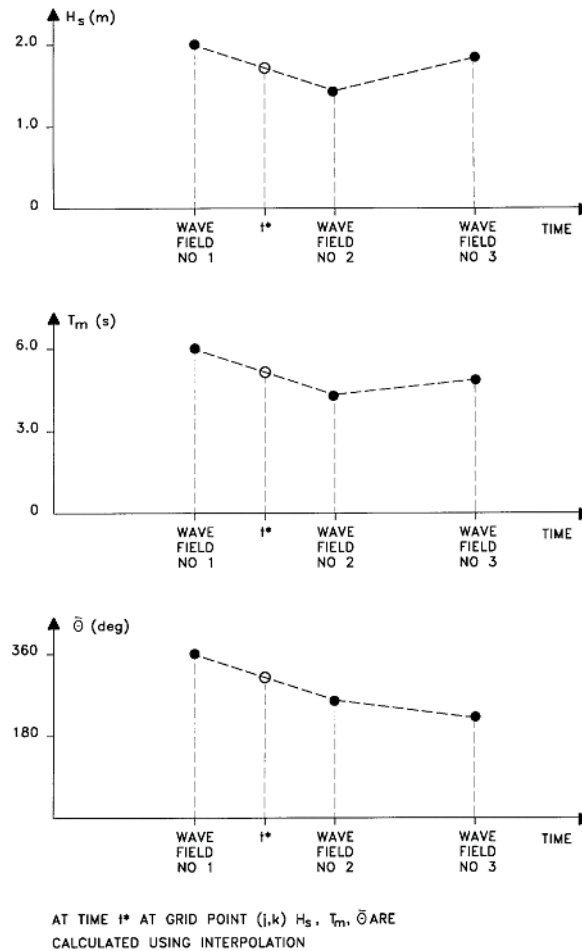

Figure 6.19 Interpolation of wave fields in time

6.19 Initial Conditions

The initial values for the hydrodynamic variables can be specified in three different ways

- Constant.
- Spatially varying surface elevation.
- Spatially varying water depth and velocities

For the last case the initial conditions can be the result from a previous simulation in which case the initial conditions effectively act as a hot start of the flow field.



To avoid generation of shock waves, it is recommended that your initial surface elevation roughly matches the boundary conditions at the start of the simulation.

Data

For the case with spatially varying surface elevation you have to prepare a data file containing the surface elevation before you set up the hydrodynamic simulation. The file must be a 2D unstructured data file (dfsu) or a 2D grid data file (dfs2). The area in the data file must cover the model area. If a dfsu-file is used, piecewise constant interpolation is used to map the data. If a dfs2-file is used, bilinear interpolation is used to map the data. In case the input data file contains a single time step, this field is used. In case the file contains several time steps, e.g. from the results of a previous simulation, the actual starting time of the simulation is used to interpolate the field in time. Therefore the starting time must be between the start and end time of the file.

For the case with spatially varying surface elevation and velocities you have to prepare two data files before you set up the hydrodynamic simulation. One containing the total water depth and one containing the velocity components in the x- and y-directions and the vertical velocity before you set up the hydrodynamic simulation. For the shallow water equations, the vertical velocity must be given in the sigma coordinate system. The first file must be a 2D unstructured data file (dfsu) or a 2D grid data file (dfs2) and the second file must be a 3D unstructured data file (dfsu) or a 3D grid data file (dfs3). The area in the data file must cover the model area. If a 2D dfsu-file is used piecewise constant interpolation is used to map the data. If a 3D dfsu file is used the mesh in the data file must match exactly the mesh in the simulation. If a dfs2-file or a dfs3-file is used bilinear interpolation is used to map the data. In case the input data file contains a single time step, this field is used. In case the file contains several time steps, e.g. from the results of a previous simulation, the actual starting time of the simulation is used to interpolate the field in time. Therefore the starting time must be between the start and end time of the file.

6.20 Boundary Conditions

Initially, the set-up editor scans the mesh file for boundary codes (sections), and displays the recognized codes and suggest a default name for each. You can re-name these names to more meaningful names in the Domain dialog (see Boundary names (p.30)).

Depending on the choice of property page you can see a geographic view or a list view of the boundaries.

The specification of boundary information for each code (section) is made subsequently. From the list view you can go to the dialog for specification by clicking on the "Go to .." button.



6.20.1 Boundary specification

For hydrodynamic boundaries there are eight types:

- Land (zero normal velocity)
- Land (zero velocity)
- Specified velocities
- Specified fluxes
- Specified level
- Specified discharge
- Free outflow
- Flather condition

It should be noted that each boundary section must contain at least 2 nodes and that flux and velocity boundary conditions cannot work if the initial bathymetry at the boundary is dry.

For stationary solid boundaries two types of boundary conditions can be applied. For the "Land (normal velocity)" the full slip boundary conditions is assumed to hold, that is, the normal velocity component is zero, while for the "Land (zero velocity)" the no slip condition is assumed to hold, that is, both the normal and tangential velocity components are zero. By default the code value for land boundaries automatically identified by the Mesh Generator is set to one. For these boundaries the full slip boundary condition are applied. If the no slip boundary conditions should be applied for these boundaries the code values should change to a value larger than one.

If you select the specified discharge option, the discharge will be distributed as it would have been in a uniform flow field with the Manning resistance law applied, i.e. is relative to $h^{5/3}$, where h is the depth. This distribution is, in most cases, a good approximation. This does not apply if there are very large gradients in temperature or salinity at the boundary or very large variations over the bathymetry or the geometry. When discharge boundary is selected, it is possible to specify whether the boundary condition should be imposed using a weak or a strong formulation. For more detail see General description (p. 105).

The free outflow condition is typically used at downstream boundaries where the water is flowing out of the model. In case of water flowing into the model domain the simulation may become unstable.

The Flather (1976) condition is one of the most efficient open boundary conditions. It is very efficient in connection with downscaling coarse model simulations to local areas (see Oddo and Pinardi (2007)). The instabilities, which are often observed when imposing stratified density at a water level boundary, can be avoided using Flather conditions.



Data

Velocity boundary

If a velocity boundary is selected the velocities in the x- and y-direction can be specified in three different ways

- Constant (in time and along boundary)
- Variable in time and constant along boundary
- Variable in time and along boundary

For the case with velocities varying in time but constant along the boundary you have to prepare a data file containing the velocity components in the x- and y-direction before you set up the hydrodynamic simulation. The data file must be a time series file (dfs0). The data must cover the complete simulation period. The time step of the input data file does not, however, have to be the same as the time step of the hydrodynamic simulation. You can choose between different types of interpolation.

For the case with velocities varying both in time and along the boundary you have to prepare a data file containing the boundary values before you set up the hydrodynamic simulation. The file must be a dfs2 file or a 2D dfsu file containing information from a vertical plane. The mapping from the input data file to the boundary section is described in Interpolation type. The data must cover the complete simulation period. The time step of the input data file does not, however, have to be the same as the time step of the hydrodynamic simulation. You can choose between different types of interpolation.

Flux boundary

If a flux boundary is selected the fluxes (the depth-integrated velocities) in the x- and y-direction can be specified in three different ways

- Constant (in time and along boundary)
- Variable in time and constant along boundary
- Variable in time and along boundary

For the case with fluxes varying in time but constant along the boundary you have to prepare a data file containing the flux components in the x- and y-direction before you set up the hydrodynamic simulation. The data file must be a time series file (dfs0). The data must cover the complete simulation period. The time step of the input data file does not, however, have to be the same as the time step of the hydrodynamic simulation. You can choose between different type of interpolation.

For the case with fluxes varying both in time and along the boundary you have to prepare a data file containing the boundary values before you set up the hydrodynamic simulation. The file must be a profile file (dfs1). The mapping from the input data file to the boundary section is described in Interpolation type. The data must cover the complete simulation period. The time step



of the input data file does not, however, have to be the same as the time step of the hydrodynamic simulation. You can choose between different type of interpolation.

Level boundary

If a level boundary is selected, the format of the water level (surface elevation, in m) can be specified as:

- Constant (in time and along boundary)
- Variable in time and constant along boundary
- Variable in time and along boundary
- Rating curve

For the case with water level varying in time but constant along the boundary you have to prepare a data file containing the water level before you set up the hydrodynamic simulation. The data file must be a time series file (dfs0). The data must cover the complete simulation period. The time step of the input data file does not, however, have to be the same as the time step of the hydrodynamic simulation. You can choose between different type of interpolation.

For the case with water level varying both in time and along the boundary you have to prepare a data file containing the boundary values before you set up the hydrodynamic simulation. The file must be a profile file (dfs1). The mapping from the input data file to the boundary section is described in Interpolation type. The data must cover the complete simulation period. The time step of the input data file does not, however, have to be the same as the time step of the hydrodynamic simulation. You can choose between different type of interpolation.

For the case with water levels defined by a Rating curve you have to define a data file containing the relation between discharge and water level. The file must be a time series file (dfs0) describing the water level by the relative item axis and the discharge by an item.

Discharge boundary

If a discharge boundary is selected, the format of the total discharge can be specified as:

- Constant (in time)
- Variable in time
- Rating curve

For the case with discharge varying in time you have to prepare a data file containing the total discharge before you set up the hydrodynamic simulation. The data file must be a time series file (dfs0). The data must cover the complete simulation period. The time step of the input data file does not, however,



have to be the same as the time step of the hydrodynamic simulation. You can choose between different types of time interpolation.

For the case with discharge defined by a Rating curve you have to define a data file containing the relation between discharge and water level. The file must be a time series file (dfs0) describing the water level by the relative item axis and the discharge by an item.

Flather boundary

If "Flather condition" is selected, the velocities in the x-and y-direction and the water level (surface elevation) must be specified. For specification of these parameters see "Velocity boundary" and "Level boundary". If discharge constraint is included the total discharge must also be specified. For specification of the total discharge see "Discharge boundary".

Rating curve

A rating curve may be selected at either a discharge or a water level boundary. The boundary value is determined from the rating curve table using the appropriate variable (water level or discharge) in the adjacent cell. Depending on the base boundary type one of the two above approaches are applied.

The use of the Rating curve format type is only recommended for downstream boundaries where water flows out of the model.

A Rating curve is a dfs0 file with axis type 'Relative item axis'. The data represent the relation between discharge (as an item) and waterlevel (specified in the relative axis).

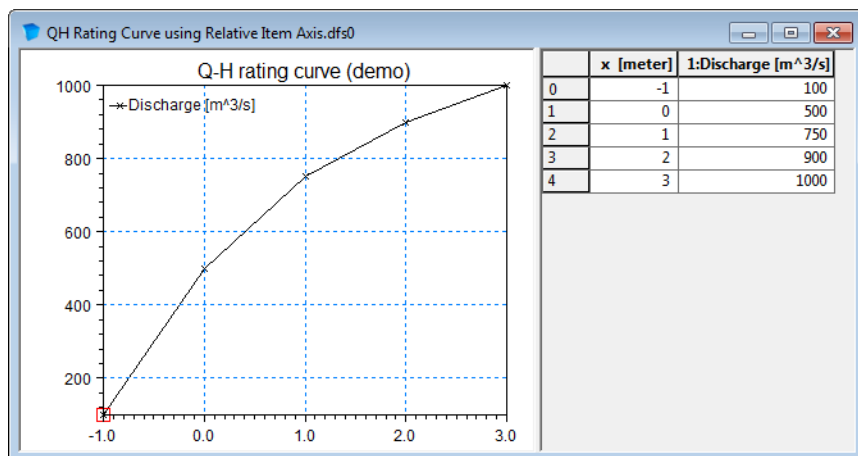

Figure 6.20 Example of Rating curve



Vertical profile

When you have selected a velocity boundary, flux boundary or a discharge boundary you must also specify the velocity profile over the water depth :

- Uniform
- Logarithmic

When a dfs2 file or a dfsu file is specified for a velocity boundary, the velocity profile is obtained from the boundary data.

Interpolation type

For the two cases with values varying in time two types of time interpolation can be selected:

- linear
- piecewise cubic

In the case with values varying along the boundary two methods of mapping from the input data file to the boundary section are available:

- normal
- reverse order

Using normal interpolation, the first and last point of the line are mapped to the first and the last node along the boundary section and the intermediate boundary values are found by linear interpolation. Using reverse order interpolation, the last and first point of the line are mapped to the first and the last node along the boundary section and the intermediate boundary values is found by linear interpolation.

Soft start

You can specify a soft start interval during which boundary values are increased from a specified reference value to the specified boundary value in order to avoid shock waves being generated in the model. The increase can either be linear or follow a sinusoidal curve.

Discharge constraint

To ensure that the discharge through the boundary is correct when using a Flather boundary, the specified velocities can be corrected. The correction is performed by adding a uniform correction to the normal velocity components.

Discharge constraint is ment to correct inaccurate spatial interpolation when taking water level and current from a coarser outer model and applying them as Flather boundary conditions.



Coriolis/wind correction

Using level boundary conditions in the presence of Coriolis and wind force, may in some cases give unrealistic results. If you specify a constant water level variation (horizontal water level) you will get a large inflow together with a large outflow at the same boundary, especially in a steady state situation, as the water level should actually be tilted. Also if you specify a variation of the water level along the boundary, the data very often do not include the effect of the local wind, e.g. if the level variation is obtained from tidal predictions. For these cases you can include tilting to improve the boundary conditions.

If tilting is included, a correction of the water level in each point along the boundary is calculated based on the steady state Navier Stokes equations. The correction takes into account the effect of Coriolis and wind force. This non-linear approach provides the best estimate in cases where you have a gentle slope on the seabed. If the seabed is very jagged at the boundary, you may have to smooth the bathymetry.

The difficulty in using the tilt facility lies in the specification of the tilting point. Presently, the tilting point is selected as the deepest point along the boundary. If the still water depth along the line is constant, the centre point is selected.

If you have two adjacent boundaries, you should also be careful not to create a conflicting situation in the corner.

By default Coriolis/wind correction is not included. Note that coriolis/wind correction is not possible for boundaries with less than 3 node points.

Pressure correction

When level boundaries is selected in combination with spatially varying wind, the level boundaries can optionally be adjusted to take into account the variation of the pressure.

By default pressure correction is included.

Radiation stress correction

When level or discharge boundaries is selected in combination with wave radiation, the boundaries values can be optionally adjusted to take into account the effect of wave radiation.

For level boundaries the correction is assumed to be zero at the deepest point along the boundary.

By default radiation stress correction is not included.



6.20.2 General description

The flux, velocity and Flather boundary conditions are all imposed using a weak approach. A ghost cell technique is applied where the primitive variables in the ghost cell are specified. The water level is evaluated based on the value of the adjacent interior cell and the velocities are evaluated based on the boundary information. For a discharge boundary the transverse velocity is set to zero for inflow and passively advected for out flow. The boundary flux is then calculated using an approximate Riemann solver.

The level boundary is imposed using a strong approach based on the characteristic theory (see e.g. Sleight et al. (1998)).

The free outflow boundary condition is also imposed using a weak approach. The primitive variables in the ghost cell are evaluated based on the value of the adjacent interior cell. A simple Neumann condition is applied where the gradient of the water level and velocities are zero.

The discharge boundary condition is imposed using both a weak formulation based on ghost cell technique described above and a strong approach based on the characteristic theory (see e.g. Sleight et al. (1998)). Note that using the weak formulation for a discharge boundary the effective discharge over the boundary may deviate from the specified discharge.

Convention of direction of boundary

When specifying a line series at the boundary it is important to know how the model defines the first and last node of the boundary.

The rule is: Follow the shoreline with the discretized domain on the left hand side, see example in Figure 6.21. When a boundary is reached, this is the first node of the boundary.

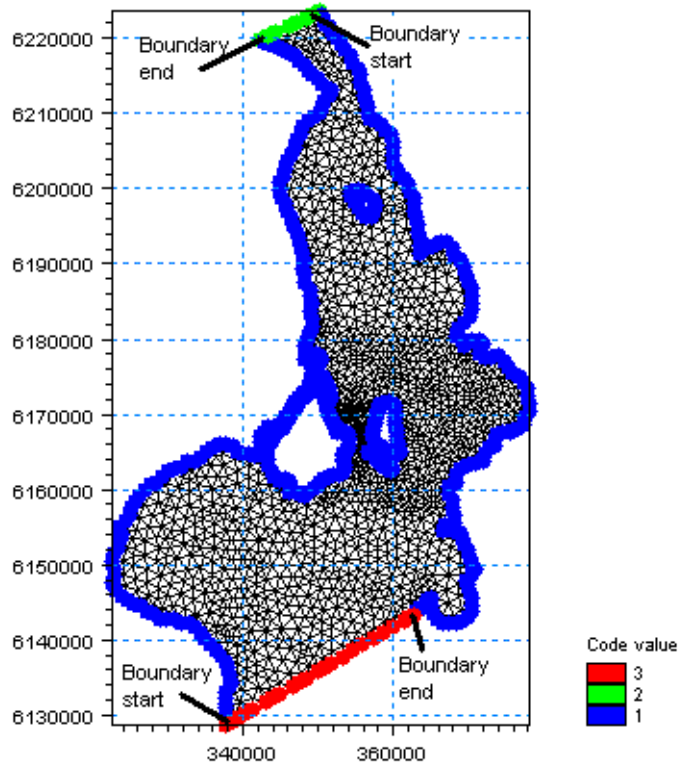

Figure 6.21 Convention of boundary start and end points.
Boundaries are defined by codes in the mesh file.

Convention of direction of discharge

By definition, discharge is positive for flow towards left when positioned at the first point and looking forward along the boundary line, i.e. referring to the Convention of direction of boundary positive discharge values will describe flow into the domain whereas negative discharge values will describe flow out of the domain.

Correction of water level

The correction of the water level due to spatially varying air pressure is adjusted according to

$$\eta = \eta^* - \frac{\rho_{air} - \rho_{neutral}}{\rho g} \quad (6.22)$$

where ρ_{air} is the air pressure, $\rho_{neutral}$ is the neutral pressure, g is the gravitational acceleration, ρ is the density of the water, η^* is the specified surface elevation and η is the corrected surface elevation applied as boundary condition.



Interpretation of dfs2 files

When using dfs2 files for boundary conditions, the y-axis in the dfs2 file is interpreted as the vertical axis given relative to a level defined by the y-axis origin. The z-level for the rows in a dfs2 file is found by

$$z(j) = \text{Origin}(y) - dy \cdot (NY - j) \quad (6.23)$$

where dy is the grid-spacing in y-axis direction, NY is the grid size -1 and $\text{Origin}(y)$ is the level for the upper row.

The origin for the spatial axis is usually 0, i.e. per default the lowest level corresponds to $-dy \cdot NY$ and the upper level correspond to $\text{MWL}=0\text{m}$. In case the boundary contains levels below or above this interval the values will correspond to the nearest level.

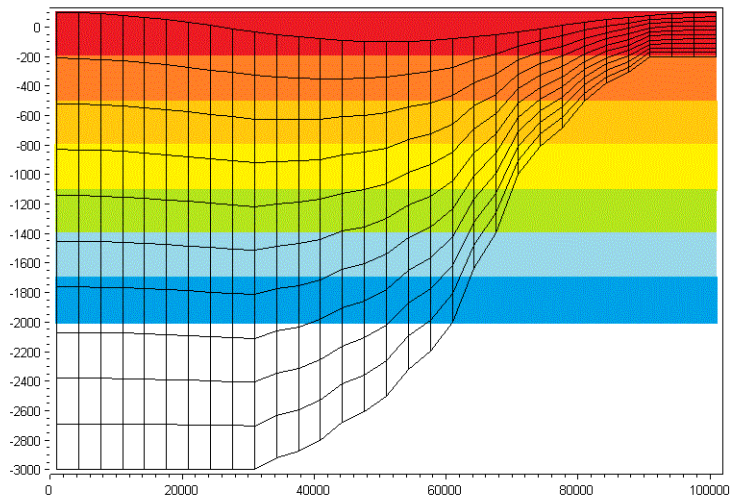

Figure 6.22 Example of dfs2 boundary with equidistant sigma mesh
Y-axis from 0 to $NY=6$, $\text{Origin},y = 100\text{m}$, $dy=300\text{m}$
Values in levels below -2000m will correspond to value in level -2000m

6.21 Temperature/Salinity Module

The Temperature/Salinity (TS) module is invoked from the specification of the density, provided baroclinic density (density depends on temperature and/or salinity) is selected (see Section 6.5 Density).

A more detailed description of the Temperature/salinity module can be found in section 7 TEMPERATURE/SALINITY MODULE.



6.22 Turbulence Module

The turbulence module is invoked from the specification of vertical eddy viscosity, provided k - ϵ model is selected (see Section 6.6 Eddy Viscosity).

A more detailed description of the Turbulence module can be found in section 8 TURBULENCE MODULE.

6.23 Decoupling

In many applications a number of simulations are performed, where the model parameters for the add-on modules are changed, but where the model parameters for the basic hydrodynamic simulations are unchanged.

If the basic flow information from a hydrodynamic simulation is saved in a number of special decoupling output files, it is possible to re-run the simulation in a decoupled mode, where instead of calculating the flow information, it is read from these files. Running a simulation in decoupled mode can significantly reduce the computational time.

If you choose to save decoupling data you have to specify three output file names. You must also specify the frequency (time step factor) by which data is going to be saved. Finally, you must give the name of the specification file for the decoupled simulation. Setting up and run a simulation using this specification file you can not change the basic parameters in the time and domain dialog and the parameters in the hydrodynamic model, but you are only allowed to change the parameters in the add-on modules.

6.23.1 Decoupling output files

The layout of the decoupled dfsu files depends on the way the model setup is executed:

- Using Shared memory approach (OpenMP) the output from the entire domain will be saved in the specified dfsu files.
- Using Distributed memory approach (MPI) the output from the individual sub-domains are initially saved in separate dfsu files. These files are merged at the end of the simulation into the specified dfsu files.



PLEASE NOTE:

When executing a flexible mesh model in decoupled mode you often use the same parallelization approach as used in the generation of the decoupled files. In case you mix the MPI and OpenMP approach when creating and using the decoupled files, reordering should be omitted.



6.23.2 Remarks and hints



Note, that in decoupled mode, the time step is not restricted by the CFL stability condition for solution of flow equations, but only by the stability restriction for the solution of the transport equations.

6.24 Outputs

Standard data files with computed results from the simulation can be specified here. Because result files tend to become large, it is normally not possible to save the computed discrete data in the whole area and at all time steps. In practice, sub areas and subsets must be selected.

In the main Outputs dialog you can add a new output file by clicking on the "New output" button. By selecting a file in the Output list and clicking on the "Delete output" button you can remove this file. For each output file you can specify the name (title) of the file and whether the output file should be included or not. The specification of the individual output files is made subsequently. You can go to the dialog for specification by clicking on the "Go to .." button. Finally, you can view the results using the relevant MIKE Zero viewing/editing tool by clicking on the "View" button during and after the simulation.

6.24.1 Geographical view

This dialog shows the geographical position of the output data.

6.24.2 Output specification

For each selected output file the field type, the output format, the data type, the treatment of flood and dry, the output file (name, location and file type) and time step must be specified. Depending on the output format and data type the geographical extend of the output data must also be specified.

Field type

For a 3D simulation both 2D and 3D field parameters can be selected. The mass budget and inundation for a domain and the discharge through a cross section can also be selected.

Output format

The possible choice of output format depends on the specified field type.

For 2D field variables the following formats can be selected:

- Point series. Selected field data in geographical defined points.



- Lines series. Selected field data along geographical defined lines.
- Area series. Selected field data in geographical defined areas.

For 3D field variables the following formats can be selected:

- Point series. Selected field data in geographical defined points.
- Lines series. Selected field data along geographical defined lines.
- Vertical plane series. Selected field data along geographical defined vertical plane.
- Volume series. Selected field data in geographical defined areas.

If mass budget is selected for the field type, you have to specify the domain for which the mass budget should be calculated. The file type will be a dfs0 file.

If discharge is selected for the field type, you have to specify the cross section through which the discharge should be calculated. The file type will be a dfs0 file.

If Inundation is selected for the field type, you have to specify the domain for which the inundation should be calculated. The file type will be an area series dfsu file.

Data type

You must specify the data type. You can select discrete values or interpolated values. For point series, area series, vertical plane series and volume series both options are available. For line series only interpolated values is available. See also Table 6.2.

If "discrete values" is selected for the data type, the values written in the data file are the cell-averaged values.

If "interpolated values" is selected for the data type, the values written in the data file are determined by 2nd order interpolation. The element in which the point is located is determined and the point value is obtained by linear interpolation using the vertex (node) values for the actual element. The vertex values are calculated from on the cell-averaged values using the pseudo-Laplacian procedure proposed by Holmes and Connell (1989).



Note, that all adjacent elements, including dry elements, are considered in the interpolation calculation.

Output file

A name and location of the output file must be specified along with the file type. The file type depends on the Output format and the Data type as shown in Table 6.2.



Vectors components and tensors components in a 2D dfsu file and horizontal vector components in a 3D dfsu file are given in the projection coordinate system. In a dfs2 file and a dfs3 file the vector and tensor components are given in the local coordinate system.

Table 6.2 List of file types for the output files

Output format	Data type	File type
Point series	Discrete values	dfs0
	Interpolated values	dfs0
Line series	Interpolated values	dfs1
Area series	Discrete values	dfsu, dfs2*
	Interpolated values	dfs2
Vertical plane series	Discrete values	dfsu
	Interpolated values	dfs2
Volume series	Discrete values	dfsu
	Interpolated values	dfs3
Cross-section	Not relevant	dfs0
Domain series	Not relevant	dfs0

* For area series with discrete values selected for the data type the file type dfs2 can only be specified when the Mesh and bathymetry is specified using a bathymetry data file.

Table 6.3 List of tools for viewing, editing and plotting results

File type	Viewing/editing tools	Plotting tools
dfs0	Time Series Editor	Plot Composer
dfs1	Profile Series Editor	Plot Composer Result Viewer
dfs2	Grid Series Editor Data Viewer	Plot Composer Result Viewer Data Viewer



Table 6.3 List of tools for viewing, editing and plotting results

File type	Viewing/editing tools	Plotting tools
dfs3	Grid Series Editor	Plot Composer Result Viewer
dfsu	Data Viewer Data Manager	Data Viewer Result Viewer Plot Composer (2D)

Flood and dry

For 2D and 3D field parameters the flood and dry can be treated in three different ways:

- Whole area
- Only wet area
- Only real wet area

Selecting the Only wet area option the output file will contain delete values for land points. The land points are defined as the points where the water depth is less than a drying depth. Selecting the Only real wet area option the output file will contain delete values for points where the water depth is less than the wetting depth. The drying depth and the wetting depth are specified on the Flood and Dry dialog. If flooding and drying is not included, both the flooding depth and the wetting depth are set to zero.

Disregarding the choice of treatment of output data, all adjacent elements, including dry elements, are considered in the interpolation calculation. Also the values for Total Water Depth will always be given for the whole area.

Time step

The temporal range refers to the time steps specified under Simulation Period in the Time dialog.

If checking the "Use simulation end time" check box, then the simulation end time specified in the Time dialog will automatically be used as last output time step. Hence, the last output time step will be automatically updated if the simulation period is changed.

Point series

You must select the map projection (Long/Lat, UTM-32, etc.) in which you want to specify the horizontal location of the points.

The geographical coordinates of the points are either taken from the dialog or from a file. The file format is an ascii file with four space separated items for



each point on separate lines. The first two items must be floats (real numbers) for the x- and y-coordinate. For 3D field data the third item must be an integer for the Layer number if discrete values are selected and a float (real number) for the z-coordinate if interpolated values are selected. The layers are numbered 1 at the bed and increasing upwards. For 2D field data the third item is unused (but must be specified). The last item (the remaining of the line) is the name specification for each point

Layer number

The layer number selected for discrete values in the point output is defined from the lowest active layer (=1) increasing upwards. In case the mesh is a type sigma mesh the number of active layers in the water column will always be the same in any point in the domain. In case the mesh is a combined sigma-z level mesh the number of active layers may vary in the domain. An example is shown in Figure 6.23.

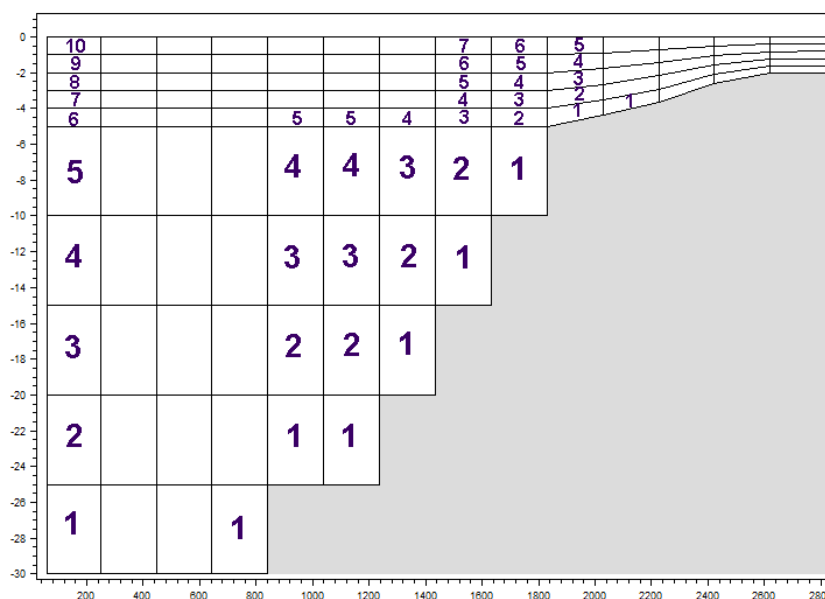

Figure 6.23 Example of layer numbers in point output specification in case of combined sigma-z level mesh.

Line series

You must select the map projection (Long/Lat, UTM-32, etc.) in which you want to specify the horizontal spatial information.

The line is defined by defining a polyline in the horizontal domain. The polyline is given by a number of geo-referenced points. A minimum of two points is required. The polyline is composed of a sequence of line segments. The line segments are straight lines between two successive points. The geo-



graphical coordinates are taken from the dialog or from a file. The file format is an ascii file with three space separated items for each of the points on separate lines. The first two items must be floats (real numbers) for the x- and y-coordinate (Easting and Northing or Longitude and Latitude). For 3D field data the third item must be a float (real number) for the z-coordinate. For 2D field data the third item is unused (but must be specified).



Note: If spherical coordinates (map projection LONG/LAT) is used for a 3D model simulation, the line must be either a horizontal or a vertical line.

Area series

You must select the map projection (Long/Lat, UTM-32, etc.) in which you want to specify the horizontal spatial information.

If discrete values is selected for the data type the discrete field data within a polygon can be selected. The closed region is bounded by a number of line segments. You must specify the coordinates of the vertex points of the polygon. Two successive points are the endpoints of a line that is a side of the polygon. The first and final point is joined by a line segment that closes the polygon. The geographical coordinates of the polygon points are taken from the dialog or from a file. The file format is an ascii file with three space separated items for each of the two points on separate lines. The first two items must be floats (real numbers) for the x- and y-coordinate. The third item is unused (but must be specified).

If interpolated values is selected for the data type the values is calculated on a structured grid (overlay). For each direction you should specify

- The origin
- The grid spacing
- The number of grid points

Furthermore, the orientation of the grid at the origin must be specified. This is defined as the angle between y-axis in the selected projection and the y-axis of the grid measured clockwise.

Vertical plane series

You must select the map projection (Long/Lat, UTM-32, etc.) in which you want to specify the horizontal spatial information.

The vertical plane is defined by defining a polyline in the horizontal domain. The polyline is given by a number of geo-referenced points. A minimum of two points is required. The polyline is composed of a sequence of line segments. The line segments are straight lines between two successive points. The geographical coordinates are taken from the dialog or from a file. The file format is an ascii file with three space separated items for each of the points on separate lines. The first two items must be floats (real numbers) for the x-



and y-coordinate (Easting and Northing or Longitude and Latitude). The third item is not used (but must be specified).

If discrete values is selected for the data type you must also specify the range of layers (first and last Layer number) which should be stored in the output file. The intersection between the line segments and the faces of the unstructured mesh is determined and added to the list of points on the polyline. A vertical unstructured mesh is then created from the horizontal polyline points and the vertical discretization for the computational mesh. For each element of the vertical mesh the discrete value at the centroid is determined as the discrete value in the element of the computational mesh, where the centroid point is located.

If interpolated values is selected for the data type the values is calculated on a structured grid (overlay). You should specify the number of grid points along the polyline. For the vertical direction the minimum and maximum z value and the number of grid points should be specified.

In the dfs2 output file Dimension 1 is the coordinate along the polyline and Dimension 2 is the vertical coordinate (z-direction). The origin in the z-direction in the dfs2 file is determined as the specified maximum z value.

Layer number

The layer number(s) selected for the vertical plane output refer to the vertical discretization specified on the Vertical Mesh page. Here the layers are numbered 1 at the lowest layer and increase upwards. In case of a combined sigma-z level mesh only the active elements are saved in the output.

Volume series

You must select the map projection (Long/Lat, UTM-32, etc.) in which you want to specify the horizontal spatial information.

If discrete values is selected for the data type the discrete field data within a polygon can be selected. The closed region is bounded by a number of line segments. You must specify the coordinates of the vertex points of the polygon. Two successive points are the endpoints of a line that is a side of the polygon. The first and final point is joined by a line segment that closes the polygon. The geographical coordinates of the polygon points are taken from the dialog or from a file. The file format is an ascii file with three space separated items for each of the two points on separate lines. The three items must be floats (real numbers) for the x-, y- and z-coordinate. You must also specify the range of layers (first and last Layer number) which should be stored in the output file.

If interpolated values is selected for the data type the values is calculated on a structured grid (overlay). For each direction you should specify

- The origin



- The grid spacing
- The number of grid points

Furthermore, the orientation of the grid at the origin must be specified. This is defined as the angle between y-axis in the selected projection and the y-axis of the grid measured clockwise.



Note, the origin, $z0_{dfs3}$, in the z-direction in the dfs3 file is determined as $z0_{dfs3} = z^0 + dz*(nz-1)$, where z^0 is the user specified origin, dz is the grid spacing and nz is the number of grid points.

Layer number

The layer number(s) selected for the volume output refer to the vertical discretization specified on the Vertical mesh page. Here the layers are numbered 1 at the lowest layer and increase upwards. In case of a combined sigma-z level mesh only the elements containing water are saved in the output. An example is shown in Figure 6.24.

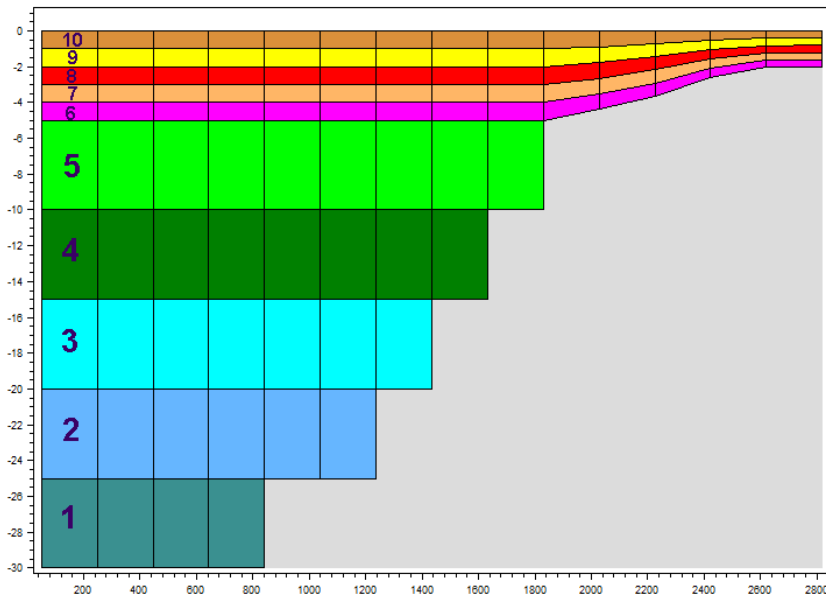

Figure 6.24 Example of layer numbers in volume output specification in case of combined sigma-z level mesh.

Cross section series

The cross section is defined by defining a polyline in the horizontal domain. The polyline is given by a number of geo-referenced points which together make up a polyline. A minimum of two points is required. The polyline is composed of a sequence of line segments. The line segments are straight lines between two successive points. The geographical coordinates are taken from



the dialog or from a file. The file format is an ascii file with three space separated items for each of the two points on separate lines. The first two items must be floats (real numbers) for the x- and y-coordinate. The third item is unused (but must be specified). The polyline (cross section) in the numerical calculations is defined as a section of element faces. The face is included in the section when the line between the two element centres of the faces crosses one of the line segments. The faces defining the cross section are listed in the log-file.

You must also select the map projection (Long/Lat, UTM-32, etc.) in which you want to specify the horizontal location of the points.

By definition, discharge is positive for flow towards left when positioned at the first point and looking forward along the cross-section line. The transports are always integrated over the entire water depth.

Domain series

The domain for which mass budget should be calculated is specified as a polygon in the horizontal domain. The closed region is bounded by a number of line segments. You must specify the coordinates of the vertex points of the polygon. Two successive points are the endpoints of a line that is a side of the polygon. The first and final point is joined by a line segment that closes the polygon. The geographical coordinates of the polygon points are taken from the dialog or from a file. The file format is an ascii file with three space separated items for each of the two points on separate lines. The first two items must be floats (real numbers) for the x- and y-coordinate. The third item is unused (but must be specified).

You must also select the map projection (Long/Lat, UTM-32 etc.) in which you want to specify the horizontal location of the points.

6.24.3 Output items

Field variables

All output is optional, i.e. the user is free to select among the variables.

Flow directions in horizontal domain are given in degrees positive clockwise from true North (going against). Flow directions in vertical domain are given in degrees positive clockwise from the upward pointing z-axis.

The convergence angle is the angle from true North to projection North (positive clockwise).

Mass Budget

You can select the mass budget calculation to be included for the flow and for the temperature and the salinity if calculation of the temperature/salinity is



included. For each selected component the following items are included in the output file:

- Total area - total volume/energy/mass within polygon
- Wet area - volume/energy/mass in the area within polygon for which the water depth is larger than the drying depth.
- Real wet area - volume/energy/mass in the area within polygon for which the water depth is larger than the wetting depth
- Dry area - volume/energy/mass in the area within polygon for which the water depth is less than the drying depth
- Transport - accumulated volume/energy/mass transported over lateral limits of polygon
- Source - accumulated volume/energy/mass added/removed by sources within polygon
- Process - accumulated volume/energy/mass added/removed by processes within polygon
- Error - accumulated volume/energy/mass error within polygon determined as the difference between the total mass change and the accumulated mass due to transport, sources and processes

The accumulated volume/energy/mass error contains the contribution due to correction of the transported component when the values become larger than the specified maximum value or lower than the specified minimum value. For the water volume the minimum value is 0, while there is no upper limit. For temperature and salinity the maximum and minimum values are specified on the Equation dialog.

For temperature the relative energy (relative to the energy at 0 °C), E (J), in a volume of water V (m³) is calculated by

$$E = c_{water}\rho_{water}T \cdot V \quad (6.24)$$

where T (°C) is the temperature, $c_{water} = 4217.0$ J/(K·kg) is the specific heat for water and $\rho_{water} = 1010.0$ kg/m³ is the density of water.

For salinity the mass of salt, M (kg), in a volume of water V (m³) is calculated by

$$M = \rho_{water}S \cdot V/1000 \quad (6.25)$$

where S (in PSU) is the salinity and $\rho_{water} = 1010.0$ kg/m³ is the density of water.



Discharge

You can select the discharge calculation to be included for the flow and for the temperature and the salinity if calculation of the temperature/salinity is included. Each selected component will result in a number of output items.

You can select between two types of output items:

- Basic
- Extended

The basic output items is as follows:

- Discharge - volume/energy/mass flux through the cross section
- Acc. discharge - accumulated volume/energy/mass flux through the cross section

The extended output items that are included in the output file in addition to the basic output items are as follows:

- Positive discharge
- Accumulated positive discharge
- Negative discharge
- Accumulated negative discharge

By definition, discharge is positive for flow towards left when positioned at the first point and looking forward along the cross-section line. The transports are always integrated over the entire water depth.

For temperature the relative energy (relative to the energy at 0 °C), E (J), in a volume of water V (m³) is calculated by

$$E = c_{water}\rho_{water}T \cdot V \quad (6.26)$$

where T (°C) is the temperature, $c_{water} = 4217.0$ J/(K·kg) is the specific heat for water and $\rho_{water} = 1010.0$ kg/m³ is the density of water.

For salinity the mass of salt, M (kg), in a volume of water V (m³) is calculated by

$$M = \rho_{water}S \cdot V / 1000 \quad (6.27)$$

where S (PSU) is the salinity and $\rho_{water} = 1010.0$ kg/m³ is the density of water.



Inundation

You can select to output an inundation map for the flow simulation. The following items may be selected for the output file

- Maximum water depth
- Time of maximum water depth
- Maximum current speed
- Time of maximum current speed
- Duration of depth above threshold

In case the latter item is selected, you have to specify a Depth threshold value as well.



7 TEMPERATURE/SALINITY MODULE

The temperature/salinity (TS) module is invoked from the specification of the density, provided baroclinic density (density depends on temperature and/or salinity) is selected (see Density (p. 40)).

The TS module sets up additional transport equations for temperature and salinity. Additionally the calculated temperature and salinity are feed-back to the hydrodynamic equations through bouyancy forcing induced by density gradients.

7.1 Equation

Here you can specify maximum and minimum values for the temperature and the salinity.

7.2 Solution Technique

The simulation time and accuracy can be controlled by specifying the order of the numerical schemes which are used in the numerical calculations. Both the scheme for time integration and for space discretization can be specified. You can select either a lower order scheme (first order) or a higher order scheme. The lower order scheme is faster, but less accurate. For more details on the numerical solution techniques, see the scientific documentation.

The time integration of the flow equations and the transport (advection-dispersion) equations is performed using a semi-implicit scheme, where the horizontal terms are treated explicitly and the vertical terms are treated implicitly. Due to the stability restriction using an explicit scheme the time step interval must be selected so that the CFL number is less than 1. A variable time step interval is used in the calculation and it is determined so that the CFL number is less than a critical CFL number in all computational nodes. To control the time step it is also possible for the user to specify a minimum time step and a maximum time step. The time step interval for the transport equations is synchronized to match the overall time step specified on the Time dialog.

The minimum and maximum time step interval and the critical CFL number is specified in the Solution Technique dialog in the HYDRODYNAMIC MODULE.

7.2.1 Remarks and hints

If the important processes are dominated by convection (flow), then higher order space discretization should be chosen. If they are dominated by diffusion, the lower order space discretization can be sufficiently accurate. In gen-



eral, the time integration method and space discretization method should be chosen alike.

Choosing the higher order scheme for time integration will increase the computing time by a factor of 2 compared to the lower order scheme. Choosing the higher order scheme for space discretization will increase the computing time by a factor of 1½ to 2. Choosing both as higher order will increase the computing time by a factor of 3-4. However, the higher order scheme will in general produce results that are significantly more accurate than the lower order scheme.

The default value for the critical CFL number is 1, which should secure stability. However, the calculation of the CFL number is only an estimate. Hence, stability problems can occur using this value. In these cases you can reduce the critical CFL number. It must be in the range from 0 to 1. Alternatively, you can reduce the maximum time step interval. Note, that setting the minimum and maximum time step interval equal to the overall time step interval specified on the Time dialog, the time integration will be performed with constant time step. In this case the time step interval should be selected so the the CFL number is smaller than 1.

The total number of time steps in the calculation and the maximum and minimum time interval during the calculation are printed in the log-file for the simulation. The CFL number can be saved in an output file.

The higher order scheme can exhibit under and over shoots in regions with steep gradients. Hence, when the higher order scheme is used in combination with a limitation on the minimum and maximum value of the concentration, mass conservation cannot be guaranteed.

7.3 Dispersion

In numerical models the dispersion usually describes transport due to non-resolved processes. In coastal areas it can be transport due to non-resolved turbulence or eddies.

In a 3D model it is important to distinguish between horizontal dispersion due to e.g. non-resolved eddies, and vertical dispersion due to e.g. bed generated turbulence. Hence, dispersion in horizontal and vertical directions is specified separately.

Especially in the horizontal directions the effects of non-resolved processes can be significant, in which case the dispersion coefficient formally should depend on the resolution.

7.3.1 Dispersion specification

The dispersion can be formulated in three different ways:



- No dispersion
- Scaled eddy viscosity formulation
- Dispersion coefficient formulation

Using the scaled eddy viscosity formulation the dispersion coefficient is calculated as the eddy viscosity used in solution of the flow equations multiplied by a scaling factor. For specification of the eddy viscosity, see Eddy Viscosity (p. 41).

Selecting the dispersion coefficient formulation you must specify the dispersion coefficient.

Data

Selecting Scaled eddy viscosity option the format of the scaling factor can be specified as

- Constant
- Varying in domain

For the case with values varying in domain you have to prepare a data file containing the scaling factor before you set up the hydrodynamic simulation. The file must be a 3D unstructured data file (dfs_u) or a 3D data grid file (dfs3). The area in the data file must cover the model area. If a dfs_u-file is used, piecewise constant interpolation is used to map the data. If a dfs3-file is used, bilinear interpolation is used to map the data.

Selecting Dispersion coefficient option the format of the dispersion coefficient can be specified as:

- Constant
- Varying in domain

For the case with values varying in domain the values are constant in the vertical domain and only varying in the horizontal domain. You have to prepare a data file containing the dispersion coefficient before you set up the hydrodynamic simulation. The file must be a 2D unstructured data file (dfs2) or a 2D data grid file (dfs2). The area in the data file must cover the model area. If a dfs_u-file is used piecewise, constant interpolation is used to map the data. If a dfs2-file is used, bilinear interpolation is used to map the data.

7.3.2 Recommended values

When more sophisticated eddy viscosity models are used, such as the Smagorinsky or $k-\varepsilon$ models, the scaled eddy formulation it is recommended to use the scaled viscosity formulation.



The scaling factor can be estimated by $1/\sigma_T$, where σ_T is the Prandtl number. To be consistent with the empirical constants for the k- ϵ turbulence model the value of σ_T should be the same as the value for the Prandtl number specified on the Equation dialog in the TURBULENCE MODULE. The default value here for the Prandtl number is 0.9 corresponding to a scaling factor of 1.1.

The dispersion coefficient is usually one of the key calibration parameters for the Temperature/Salinity Module. It is therefore difficult to device generally applicable values for the dispersion coefficient. However, using Reynolds analogy, the dispersion coefficient can be written as the product of a length scale and a velocity scale. In shallow waters the length scale can often be taken as the water depth, while the velocity scale can be given as a typical current speed.

Values in the order of 1 are usually recommended for the scaling factor for the horizontal plane.

The scaling factor for the vertical plane is usually much smaller, e.g. 0.00001. As it is a calibration factor this can sometimes even be 0.

7.4 Heat Exchange

The heat in the water can interact with the atmosphere through heat exchange. The heat exchange is calculated on basis of the four physical processes:

1. Latent heat flux (evaporation)
2. Sensible heat (convection)
3. Short wave radiation
4. Long wave radiation

The calculations are using the local Atmospheric conditions.

The heat exchange affects the temperature (if varying). For more details see the scientific documentation.

7.4.1 Specification

Latent heat

The latent heat process concerns the loss of energy due to evaporation.

For the latent heat flux you need to specify the constant in Dalton's law and the wind coefficient in Dalton's law, respectively.

The critical wind speed is the minimum wind speed used in the calculation of the latent heat flux.



Sensible heat

The sensible heat process concerns the convective heat transfer between the water and the atmosphere.

For the sensible heat flux you need to specify the transfer coefficient for heating and cooling.

The critical wind speed is the minimum wind speed used in the calculation of the sensible heat flux.

Short wave radiation

The short wave radiation can be formulated in one of three ways:

- Empirical
- Specified solar radiation
- Specified net short wave radiation

The short wave penetration is dependent on the visibility. This is specified by the parameter "Light extinction coefficient". You can also specify an exchange coefficient, which is specified as the "Beta in Beer's Law".

Dependent on the choice of formulation, additional parameters must be specified.

Empirical

Using the empirical formulation it is necessary to define the sun constants a and b in Ångström's law, the local standard meridian for the time zone and the time displacement (if summer time is effective).

Specified solar radiation

Using the specified solar radiation it is necessary to define the local standard meridian for the time zone and the time displacement (if summer time is effective). It is also necessary to specify the solar radiation data.

Specified net short wave radiation

Using the specified net short wave radiation it is necessary to specify the values for the net short wave radiation.

Note regarding time specification

Summer time should be specified as +1 hour. We although recommend using standard time and then convert the timing when presenting the results if needed.

The local standard meridian should be given corresponding to the actual time zone, e.g for a simulation at the US East cost (UTC-8) you would normally use -120 degrees (15×8). The definition is negative westward and positive eastward.



Long wave radiation

The long wave radiation can be formulated in one of three ways:

- Empirical
- Specified atmospheric radiation
- Specified long wave radiation

In case the formulation chosen is not the empirical, you have to specify the radiation data.

Atmospheric conditions

If you include heat exchange, you have to specify the air temperature and the relative humidity.

If you want to include empirical wave radiation you have to specify the clearness coefficient. A clearness coefficient of 100% specifies a clear sky and 0% specifies cloudy weather.

Data

The format of the data for heat exchange calculation can be specified as:

- Constant (in both time and domain)
- Varying in time and constant in domain
- Varying in time and domain

For the case with data varying in time but constant in domain you have to prepare a data file containing the relevant variable before you set up the hydrodynamic simulation. The data file must be a time series file (dfs0). The data must cover the complete simulation period. The time step of the input data file does not, however, have to be the same as the time step of the hydrodynamic simulation. A linear interpolation will be applied if the time steps differ.

For the case with data varying both in time and domain you have to prepare a data file containing the relevant variable before you set up the hydrodynamic simulation. The file must be a 2D unstructured data file (dfs1) or a 2D grid data file (dfs2). The area in the data file must cover the model area. If a dfs1-file is used, piecewise constant interpolation is used to map the data. If a dfs2-file is used, bilinear interpolation is used to map the data. The data must cover the complete simulation period. The time step of the input data file does not, however, have to be the same as the time step of the hydrodynamic simulation. A linear interpolation will be applied if the time steps differ.



7.5 Precipitation-Evaporation

If your simulation include precipitation and/or evaporation, you need to specify the temperature of the precipitated and evaporated water mass. The precipitation and evaporation can be included in one of two ways:

- **Ambient water temperature**
The temperature of the precipitated/evaporated water mass is set equal to the concentration of the ambient sea water.
- **Specified temperature**
The temperature of the precipitated/evaporated water mass is specified explicitly.

If you have chosen the net precipitation option in the Precipitation-Evaporation dialog in the HYDRODYNAMIC MODULE the precipitation temperature will be used when the specified net-precipitation is positive. When the net-precipitation is negative, the evaporation temperature is used.

The salinity of the precipitated/evaporated water mass is assumed to be zero.

Data

Selecting the specified temperature option the format of the temperature can be specified as:

- Constant (in both time and domain)
- Varying in time and constant in domain
- Varying in time and domain

For the case with temperature varying in time but constant in domain you have to prepare a data file containing the temperature before you set up the hydrodynamic simulation. The data file must be a time series file (dfs0). The data must cover the complete simulation period. The time step of the input data file does not, however, have to be the same as the time step of the hydrodynamic simulation. A linear interpolation will be applied if the time steps differ.

For the case with temperature varying both in time and domain you have to prepare a data file containing the temperature before you set up the hydrodynamic simulation. The file must be a 2D unstructured data file (dfs1) or a 2D grid data file (dfs2). The area in the data file must cover the model area. If a dfs1-file is used, piecewise constant interpolation is used to map the data. If a dfs2-file is used, bilinear interpolation is used to map the data. The data must cover the complete simulation period. The time step of the input data file does not, however, have to be the same as the time step of the hydrodynamic simulation. A linear interpolation will be applied if the time steps differ.



Soft start interval

You can specify a soft start interval during which the precipitation/evaporation temperature is increased linearly from 0 to the specified values of the precipitation/evaporation temperature. By default the soft start interval is zero (no soft start).

7.6 Infiltration

If you have included infiltration in your simulation you need to specify how the temperature is described in the infiltrated water mass. There are two different ways to do this:

- Ambient water temperature
The temperature of infiltrated water mass is set equal to the temperature of the ambient sea water.
- Specified temperature
The temperature of the infiltrated water mass is specified explicitly.

The salinity of the infiltrated water mass is set equal to the ambient sea water.

Data

Selecting the specified temperature option the format of the temperature can be specified as:

- Constant (in both time and domain)
- Varying in time and constant in domain
- Varying in time and domain

For the case with temperature varying in time but constant in domain you have to prepare a data file containing the temperature before you set up the hydrodynamic simulation. The data file must be a time series file (dfs0). The data must cover the complete simulation period. The time step of the input data file does not, however, have to be the same as the time step of the hydrodynamic simulation. A linear interpolation will be applied if the time steps differ.

For the case with temperature varying both in time and domain you have to prepare a data file containing the temperature before you set up the hydrodynamic simulation. The file must be a 2D unstructured data file (dfs1) or a 2D grid data file (dfs2). The area in the data file must cover the model area. If a dfs1-file is used, piecewise constant interpolation is used to map the data. If a dfs2-file is used, bilinear interpolation is used to map the data. The data must cover the complete simulation period. The time step of the input data file does not, however, have to be the same as the time step of the hydrodynamic simulation. A linear interpolation will be applied if the time steps differ.



Soft start interval

You can specify a soft start interval during which the infiltration temperature is increased linearly from 0 to the specified values of the infiltration temperature. By default the soft start interval is zero (no soft start).

7.7 Sources

Point sources of temperature (heat) and salinity are important in many applications as e.g. outlets from rivers, intakes and outlets from cooling water or desalination plants.

In the Temperature/Salinity Module the temperature and/or salinity in every sources point can be specified. The number of sources, their generic names, location and discharges magnitude are specified in the Sources dialog in the HYDRODYNAMIC MODULE.

Depending on the choice of property page you can see a geographic view or a list view of the sources.

The source information is specified individually for each source and for temperature and salinity. From the list view you can go to the dialog for specification by clicking on the "Go to.." button.

7.7.1 Source Specification

The type of sources can be specified as

- Specified temperature/salinity
- Excess temperature/salinity

The source flux is calculated as $Q_{\text{source}} \times C_{\text{source}}$, where Q_{source} is the magnitude of the source and C_{source} is the temperature/salinity of the source. The magnitude of the source is specified in the Sources dialog in the HYDRODYNAMIC MODULE.

Selecting the temperature/salinity option the source temperature/salinity is the specified temperature/salinity if the magnitude of the source is positive (water is discharge into the ambient water). The source temperature/salinity is the temperature/salinity at the source point if the magnitude of the source is negative (water is discharge out the ambient water). This option is pertinent to e.g. river outlets or other sources where the concentration is independent of the surrounding water.

Selecting the excess temperature/salinity option the source temperature/salinity is the sum of the specified excess temperature/salinity and temperature/salinity at a point in the model if the magnitude of the source is positive (water is discharge into the ambient water). If it is an isolated source



the point is the location of the source. If it is a connected source the point is the location where water is discharged out of the water. The source temperature/salinity is the temperature/salinity at the source point if the magnitude of the source is negative (water is discharge out the ambient water). This type can be used to describe e.g. a heat exchange or other processes where the temperature (heat) or salinity is added to the water by a diffusion process.

Data

The format of the source information can be specified as

- Constant (in time)
- Varying in time

For the case with source concentration varying in time you have to prepare a data file containing the concentration (temperature or salinity) of the source before you set up the hydrodynamic simulation. The data file must be a time series file (dfs0). The data must cover the complete simulation period. The time step of the input data file does not, however, have to be the same as the time step of the hydrodynamic simulation. A linear interpolation will be applied if the time steps differ.

7.7.2 Remarks and hints

Point sources are entered into elements, such that the inflowing mass of the component initially is distributed over the element where the source resides. Therefore the temperature and salinity seen in the results from the simulation usually is lower than the source specified temperature and salinity.

7.8 Initial Conditions

The initial conditions are the spatial distribution of temperature and salinity throughout the computational domain at the beginning of the simulation. The initial conditions can be the result from a previous simulation in which case the initial conditions effectively act as a hot start of the temperature and salinity field.

The initial conditions are specified individually for temperature and salinity.

Data

The format of the initial conditions for temperature and salinity can be specified as:

- Constant (in domain)
- Varying in domain



For the case with varying in domain you have to prepare a data file containing the initial conditions (temperature or salinity) before you set up the hydrodynamic simulation. The file must be a 3D unstructured data file (dfs0) or a 3D grid data file (dfs3). The area in the data file must cover the model area. If a dfs0 file is used, the mesh in the data file must match exactly the mesh in the simulation. If a dfs3-file is used, bilinear interpolation is used to map the data. In case the input data file contains a single time step, this field is used. In case the file contains several time steps, e.g. from the results of a previous simulation, the actual starting time of the simulation is used to interpolate the field. Therefore the starting time must be within the start and end time of the file.

7.9 Boundary Conditions

Initially, the set-up editor scans the mesh file for boundary codes (sections), and displays the recognized codes and suggest a default name for each. You can re-name these names to more meaningful names in the Domain dialog (see Boundary names (p. 30)).

Depending on the choice of property page you can get a geographic view or a list view of the boundaries.

The boundary conditions are specified individually for each code (section) and for the temperature and the salinity. From the list view you can go to the dialog for specification by clicking on the "Go to .." button.

7.9.1 Boundary specification

You can choose between the following three boundary types:

- Land
- Specified values (Dirichlet boundary condition)
- Zero gradient (Neumann boundary condition)

Data

If specified values (Dirichlet boundary condition) is selected the format of the temperature and/or salinity at the boundary can be specified as

- Constant (in time and along boundary)
- Varying in time and constant along boundary
- Varying in time and along boundary

For the case with boundary data varying in time but constant along the boundary you have to prepare a data file containing the boundary values (temperature or salinity) before you set up the hydrodynamic simulation. The data file must be a time series file (dfs0). The data must cover the complete



simulation period. The time step of the input data file does not, however, have to be the same as the time step of the hydrodynamic simulation. You can choose between different types of interpolation (see Interpolation type).

For the case with boundary data varying both in time and along the boundary you have to prepare a data file containing the boundary values (temperature or salinity) before you set up the hydrodynamic simulation. The data file must be a dfs2 file or a 2D dfsu file containing information from a vertical plane. The data must cover the complete simulation period. The time step of the input data file does not, however, have to be the same as the time step of the hydrodynamic simulation. You can choose between different types of time interpolation.

Interpolation type

For the two cases with values varying in time two types of time interpolation can be selected:

- Linear
- Piecewise cubic.

In the case with values varying along the boundary two methods of mapping from the input data file to the boundary section are available:

- Normal
- Reverse order

Using normal interpolation the first and last point of the line are mapped to the first and the last node along the boundary section and the intermediate boundary values are found by linear interpolation. Using reverse order interpolation the last and first point of the line are mapped to the first and the last node along the boundary section and the intermediate boundary values is found by linear interpolation.

Soft start interval

You can specify a soft start interval during which boundary values are increased from a specified reference value to the specified boundary value in order to avoid shock waves being generated in the model. The increase can either be linear or follow a sinusoidal curve.



8 TURBULENCE MODULE

The turbulence module is invoked from the specification of vertical eddy viscosity, provided a k - ε model is selected (see Section 6.6, Eddy Viscosity).

The turbulence model is based on a standard k - ε model, with buoyancy extension, see e.g. Rodi (1980). This model uses transport equations for the turbulent kinetic energy (TKE), k , and the dissipation of TKE, ε , to describe the turbulence.

8.1 Equation

The turbulence model is based on a standard k - ε model, with buoyancy extension, see e.g. Rodi (1980). This model uses transport equations for the turbulent kinetic energy (TKE), k , and the dissipation of TKE, ε , to describe the turbulence.

In the k - ε closure model, the Prandtl number, which appears in the transport equations for k and ε , can be modified explicitly following the empirical expression of Munk and Anderson (1948). This correction will introduce a damping of the buoyancy production in case of stable stratification. This damping is included by default.

Empirical constants

Four empirical constants can be specified for the standard k - ε model: c_{1e} , c_{2e} , c_{3e} are related to the equation for the dissipation of TKE and the Prandtl number (σ_T) is used in the buoyancy production term. c_{my} (c_{μ}) is an empirical constant used in the expression for determination of the eddy viscosity (see section 6.6, Eddy Viscosity).

Several carefully calibrated empirical coefficients enter the k - ε turbulence model. Therefore great care should be taken if you decide to alter any of these coefficients. The empirical constants are listed in Table 8.1.

Table 8.1 Default empirical constants in the k - ε turbulence model (see Rodi, 1980)

c_{1e}	c_{2e}	c_{3e}	Prandtl	c_{my}
1.44	1.92	0	0.9	0.09

Maximum and minimum values

Here you specify maximum and minimum values for the TKE, k , and the dissipation of TKE, ε .



8.2 Solution Technique

The simulation time and accuracy can be controlled by specifying the order of the numerical schemes that are used in the numerical calculations. Both the scheme for time integration and for space discretization can be specified. You can select either a lower order scheme (first order) or a higher order scheme. The lower order scheme is faster, but less accurate. For more details on the numerical solution techniques, see the scientific documentation.

The time integration of the flow equations and the transport (advection-dispersion) equations is performed using a semi-implicit scheme, where the horizontal terms are treated explicitly and the vertical terms are treated implicitly. Due to the stability restriction using an explicit scheme the time step interval must be selected so that the CFL number is less than 1. A variable time step interval is used in the calculation and it is determined so that the CFL number is less than a critical CFL number in all computational nodes. To control the time step it is also possible for the user to specify a minimum time step and a maximum time step. The time step interval for the transport equations is synchronized to match the overall time step specified on the Time dialog.

The minimum and maximum time step interval and the critical CFL number is specified in the Solution Technique dialog in the HYDRODYNAMIC MODULE.

8.2.1 Remarks and hints

If the important processes are dominated by convection (flow), then higher order space discretization should be chosen. If they are dominated by diffusion, the lower order space discretization can be sufficiently accurate. In general, the time integration method and space discretization method should be chosen alike.

Choosing the higher order scheme for time integration will increase the computing time by a factor of 2 compared to the lower order scheme. Choosing the higher order scheme for space discretization will increase the computing time by a factor of 1½ to 2. Choosing both as higher order will increase the computing time by a factor of 3-4. However, the higher order scheme will in general produce results that are significantly more accurate than the lower order scheme.

The default value for the critical CFL number is 1, which should secure stability. However, the calculation of the CFL number is only an estimate. Hence, stability problems can occur using this value. In these cases you can reduce the critical CFL number. It must be in the range from 0 to 1. Alternatively, you can reduce the maximum time step interval. Note, that setting the minimum and maximum time step interval equal to the overall time step interval specified on the Time dialog, the time integration will be performed with constant



time step. In this case the time step interval should be selected so the CFL number is smaller than 1.

The total number of time steps in the calculation and the maximum and minimum time interval during the calculation are printed in the log-file for the simulation. The CFL number can be saved in an output file.

The higher order scheme can exhibit under and over shoots in regions with steep gradients. Hence, when the higher order scheme is used in combination with a limitation on the minimum and maximum value of the concentration mass conservation cannot be guaranteed.

8.3 Dispersion

The diffusion coefficient in the turbulence module is estimated based on the eddy viscosity used in solution of the flow equations divided by a scaling factor σ . For specification of the eddy viscosity (see section 6.6, Eddy Viscosity). The diffusion coefficient is calculated as the eddy viscosity coefficient divided by a Prandtl number.

You can specify the horizontal and vertical Prandtl number used in the transport equations for the turbulent kinetic energy, k , and the dissipation of TKE, ε , respectively.

8.4 Initial Conditions

The initial conditions are the spatial distribution of the turbulent kinetic energy, k , and the dissipation of TKE, ε , throughout the computational domain at the beginning of the simulation. Initial conditions must always be provided. The initial conditions can be the result from a previous simulation in which case the initial conditions effectively act as a hot start of the field for the turbulent kinetic energy and the dissipation of TKE.

The initial conditions are specified individually for the turbulent kinetic energy, k , and the dissipation of TKE, ε .

Data

The initial condition for the turbulent kinetic energy, k , and the dissipation of TKE, ε , can be specified in two ways

- Constant (in domain)
- Varying in domain

For the case with varying in domain you have to prepare a data file containing the initial condition (turbulent kinetic energy or the dissipation of TKE) before you set up the hydrodynamic simulation. The file must be a 3D unstructured data file (dfs) or a 3D grid data file (dfs3).



The area in the data file must cover the model area. If a dfsu-file is used, the mesh in the data file must match exactly the mesh in the simulation. If a dfs3-file is used, bilinear interpolation is used to map the data. In case the input data file contains a single time step, this field is used. In case the file contains several time steps, e.g. from the results of a previous simulation, the actual starting time of the simulation is used to interpolate the field in time. Therefore the starting time must be between the start and end time of the file.

8.4.1 Recommended values

Generally, it is very difficult to estimate realistic initial conditions for the turbulent kinetic energy and the dissipation of TKE. Therefore, it is recommended to apply the minimum values. $k_{min} = 1.0 \cdot 10^{-7} \text{ m}^2/\text{s}^2$ and $\varepsilon_{min} = 5 \cdot 10^{-10} \text{ m}^2/\text{s}^3$, yielding $\nu_T = 1.8 \cdot 10^{-6} \text{ m}^2/\text{s}$ (see section 6.6, Eddy Viscosity).

8.5 Boundary Conditions

Initially, the set-up editor scans the mesh file for boundary codes (sections), and displays the recognized codes and suggest a default name for each. You can re-name these names to more meaningful names in Domain dialog (see Boundary names (p. 30)).

Depending on the choice of property page you can get a geographic view or a list view of the boundaries.

The boundary conditions are specified individually for the turbulent kinetic energy, k , and the dissipation of TKE, ε , and for each code (section). From the list view you can go to the dialog for specification by clicking on the “Go to ..” button.

8.5.1 Boundary Specification

You can choose between the following three boundary types:

- Land
- Specified values (Dirichlet boundary condition)
- Zero gradient (Neumann boundary condition).

Data

If specified values (Dirichlet boundary condition) is selected the turbulent kinetic energy and the dissipation of TKE at the boundary can be specified in three different ways:

- Constant (in time and along boundary)
- Variable in time and constant along boundary



- Variable in time and along boundary

For the case with boundary data varying in time but constant along the boundary you have to prepare a data file containing the boundary values (turbulent kinetic energy and the dissipation of TKE) before you set up the hydrodynamic simulation. The data file must be a time series file (dfs0). The data must cover the complete simulation period. The time step of the input data file does not, however, have to be the same as the time step of the hydrodynamic simulation. You can choose between different types of interpolation (see Interpolation type).

For the case with boundary data varying both in time and along the boundary you have to prepare a data file containing the boundary values (turbulent kinetic energy and the dissipation of TKE) before you set up the hydrodynamic simulation. The file must be a dfs2 file or a 2D dfsu file containing information from a vertical plane. The data must cover the complete simulation period. The time step of the input data file does not, however, have to be the same as the time step of the hydrodynamic simulation. You can choose between different types of time interpolation.

Interpolation type

For the two cases with values varying in time two types of time interpolation can be selected:

- Linear
- Piecewise cubic

In the case with values varying along the boundary two methods of mapping from the input data file to the boundary section are available:

- Normal
- Reverse order

Using normal interpolation the first and last point of the line are mapped to the first and the last node along the boundary section and the intermediate boundary values are found by linear interpolation. Using reverse order interpolation the last and first point of the line are mapped to the first and the last node along the boundary section and the intermediate boundary values is found by linear interpolation.

Soft start interval

You can specify a soft start interval during which boundary values are increased from a specified reference value to the specified boundary value in order to avoid shock waves being generated in the model. The increase can either be linear or follow a sinusoidal curve.



8.5.2 Recommended values

Generally, it is very difficult to estimate realistic boundary variations for the turbulent kinetic energy and the dissipation of TKE. Therefore, it is recommended to apply the minimum values. $k_{min} = 1.0 \cdot 10^{-7} \text{ m}^2/\text{s}^2$ and $\varepsilon_{min} = 5 \cdot 10^{-10} \text{ m}^2/\text{s}^3$.



9 LIST OF REFERENCES

- Aupoix, B., (1984), Eddy Viscosity Subgrid Scale Models for Homogeneous Turbulence, in *Macroscopic Modelling of Turbulent Flow*, Lecture Notes in Physics, Proc. Sophie-Antipolis, France.
- Choi, K.W. and J.H.W. Lee, (2007), Distributed Entrainment Sink Approach for Modeling Mixing and Transport in the Intermediate Field, *J. Hydraulic Eng.* 133 (7), 804-815.
- Delhez, E. J. M., Deelersijder, E., Maouchet, A., Beckers, J. M. (2003), On the age of radioactive tracers, *J. Marine Systems*, 38, pp. 277-286.
- Flather, R. A. (1976), A tidal model of the northwest European continental shelf, *Memories de la Societe Royale des Sciences de Liege* 6 (10), 141-164.
- Fredsøe, J. (1984), Turbulent boundary layers in Combined Wave Current Motion. *J. Hydraulic Engineering*, ASCE, Vol 110, No. HY8, pp. 1103-1120.
- Geernaert G.L. and Plant W.L (1990), Surface Waves and fluxes, *Volume 1 - Current theory*, Kluwer Academic Publishers, The Netherlands.
- Holmes, D. G. and Connell, S. D. (1989), Solution of the 2D Navier-Stokes on unstructured adaptive grids, AIAA Pap. 89-1932 in Proc. AIAA 9th CFD Conference.
- Horiuti, K. (1987), Comparison of Conservative and Rotational Forms in Large Eddy Simulation of Turbulent Channel Flow, *Journal of Computational Physics*, 71, pp 343-370.
- Hungr, O. (1995). A model for the runout analysis of rapid flow slides, debris flows, and avalanches. *Canadian Geotechnical Journal*, 32(4), 610-623.
- Jeyapalan, J. K., Duncan, J. M., & Seed, H. B. (1983). Investigation of flow failures of tailings dams. *Journal of geotechnical engineering*, 109(2), 172-189.
- Jirka, Gerhard H. (2004), Integral Model for Turbulent Buoyant Jets in Unbounded Stratified Flows. Part I: Single Round Jet. *Environmental Fluid Mechanics*, 4: 1-56.
- Jones, O., Zyserman, J.A. and Wu, Yushi (2014), Influence of Apparent Roughness on Pipeline Design Conditions under Combined Waves and Current, *Proceedings of the ASME 2014 33rd International Conference on Ocean, Offshore and Arctic Engineering*.
- Julien, P.Y. (2010), Erosion and Sedimentation, *Second Edition*. Cambridge University Press.



- Kramer S.C., M. D. Piggott, J. Hill, L. Kregtin, D. Pritchard, B. Elsaesser (2014), The modelling of tidal turbine farms using multi-scale, unstructured mesh models, Proceedings of the 2nd International Conference on Environmental Interactions of Marine Renewable Energy Technologies (EIMR2014), 28 April - 02 May 2014, Stornoway, Isle of Lewis, Outer Hebrides, Scotland.
- Leonard, A. (1974), Energy Cascades in Large-Eddy Simulations of Turbulent Fluid Flows, *Advances in Geophysics*, 18, pp 237-247.
- Lilly, D.K. (1966), On the Application of the Eddy Viscosity Concept in the Inertial Subrange of Turbulence, *NCAR Manuscript No. 123*, National Center for Atmospheric Research, Boulder, Colorado.
- Munk, W., Anderson, E. (1948), Notes on the theory of the thermocline, *Journal of Marine Research*, 7, 276-295.
- Naef, D., Rickenmann, D., Rutschmann, P., & McArdell, B. W. (2006). Comparison of flow resistance relations for debris flows using a one-dimensional finite element simulation model. *Natural Hazards and Earth System Science*, 6(1), 155-165.
- Oddo P. and N. Pinardi (2007), Lateral open boundary conditions for nested limited area models: A scale selective approach, *Ocean Modelling* 20 (2008) 134-156.
- Pastor, M., Quecedo, M., González, E., Herreros, M. I., Merodo, J. F., & Mira, P. (2004). Simple approximation to bottom friction for Bingham fluid depth integrated models. *Journal of Hydraulic Engineering*, 130(2), 149-155.
- Rodi, W. (1980), Turbulence Models and Their Application in Hydraulics - A State of the Art Review, *Special IAHR Publication*.
- Roe, P. L. (1981), Approximate Riemann solvers, parameter vectors, and difference-schemes, *Journal of Computational Physics*, 43, 357-372
- Smagorinsky (1963), J. General Circulation Experiment with the Primitive Equations, *Monthly Weather Review*, 91, No. 3, pp 99-164.
- Sleigh, P.A., Gaskell, P.H., Bersins, M. and Wright, N.G. (1998), An unstructured finite-volume algorithm for predicting flow in rivers and estuaries, *Computers & Fluids*, Vol. 27, No. 4, 479-508.
- Song, Y and Haidvogel D., (1994) A semi-implicit ocean circulation model using a generalized topography-following coordinate system, *Journal of Comp. Physics*, 115, pp. 228-244.
- Toro, E.F., Spruce M., Speares W. (1994), Restoration of the contact surface in the HLL Riemann solver, *Shock Waves*, 4(1), 25-34.
- Wu, Jin (1994), The sea surface is aerodynamically rough even under light winds, *Boundary layer Meteorology*, 69, 149-158.



Wu, Jin (1980), Wind-stress Coefficients over sea surface and near neutral conditions - A revisit, *J. Phys. Oceanogr.*, 10, 727-740.

Zhao, D.H., Shen, H.W., Tabios, G.Q., Tan, W.Y. and Lai, J.S. (1994), Finite-volume 2-dimensional unsteady-flow model for river basins, *Journal of Hydraulic Engineering*, ASCE, 1994, 120, No. 7, 863-833.





INDEX



A	
About this guide	9
Area series	114
ASCII file	79
B	
Bathymetry data file	23
Bed resistance	45
Boundary conditions	98, 131, 136
Bridge	91
C	
CFL number	36
Composite structures	91
Connected source	59
Convention of boundary	105
Convergence angle	117
Coordinate type	24
Coriolis forcing	48
Courant-Friedrich-Lévy	36
Culvert	70
D	
Damping	133
Datum shift	24
Decomposition	25
Decoupled mode	25, 108, 109
Density	40
Direction of boundary	105
Direction of discharge	106
Discharge table	79
Dispersion	122, 135
Drag coefficient	50, 88
Drying depth	39
E	
Eddy viscosity	41
Evaporation	53, 127
Excess temperature	129
F	
Flood and dry	39
Flow direction	94, 117
G	
Gate	82
H	
Heat exchange	124
Horizontal dispersion	122
I	
Ice coverage	50
Infiltration	54
Initial conditions	97, 130, 135
Inundation	120
J	
Jet	59
K	
k-e model	44, 133
L	
Latent heat	124
Layer number in output	113, 116
Layer number in source	61
Leakage	54
Line series	113
Log law	43
M	
Mesh file	22
MIKE Zero Mesh	22
Minimum depth cutoff	24
N	
Neutral pressure	49
O	
Outputs	109
P	
Pier	85
Pier section	87
Point series	112
Prandtl number	133
Precipitation	53, 127
Pressure correction	104
R	
Radiation stress	58
Richardson number	44



S

Salinity	121
Sensible heat	125
Simple source	59
Smagorinsky	43
Sources	59, 129
Standard source	59

T

Temperature	121
Tensor	111
Time parameters	33
Turbine	88
Turbine angles	91

U

User background	9
---------------------------	---

V

Vector	111
Vertical mesh	25

W

Wave field	95
Wave radiation	58
Weir	66
Wetting depth	39
Wind forcing	48

