

MIKE Animator Plus

A Powerful Visualisation Tool
for DHI 2D & 3D Model Applications





PLEASE NOTE

COPYRIGHT

This document refers to proprietary computer software which is protected by copyright. All rights are reserved. Copying or other reproduction of this manual or the related programs is prohibited without prior written consent of DHI. For details please refer to your 'DHI Software Licence Agreement'.

LIMITED LIABILITY

The liability of DHI is limited as specified in Section III of your 'DHI Software Licence Agreement':

'IN NO EVENT SHALL DHI OR ITS REPRESENTATIVES (AGENTS AND SUPPLIERS) BE LIABLE FOR ANY DAMAGES WHATSOEVER INCLUDING, WITHOUT LIMITATION, SPECIAL, INDIRECT, INCIDENTAL OR CONSEQUENTIAL DAMAGES OR DAMAGES FOR LOSS OF BUSINESS PROFITS OR SAVINGS, BUSINESS INTERRUPTION, LOSS OF BUSINESS INFORMATION OR OTHER PECUNIARY LOSS ARISING OUT OF THE USE OF OR THE INABILITY TO USE THIS DHI SOFTWARE PRODUCT, EVEN IF DHI HAS BEEN ADVISED OF THE POSSIBILITY OF SUCH DAMAGES. THIS LIMITATION SHALL APPLY TO CLAIMS OF PERSONAL INJURY TO THE EXTENT PERMITTED BY LAW. SOME COUNTRIES OR STATES DO NOT ALLOW THE EXCLUSION OR LIMITATION OF LIABILITY FOR CONSEQUENTIAL, SPECIAL, INDIRECT, INCIDENTAL DAMAGES AND, ACCORDINGLY, SOME PORTIONS OF THESE LIMITATIONS MAY NOT APPLY TO YOU. BY YOUR OPENING OF THIS SEALED PACKAGE OR INSTALLING OR USING THE SOFTWARE, YOU HAVE ACCEPTED THAT THE ABOVE LIMITATIONS OR THE MAXIMUM LEGALLY APPLICABLE SUBSET OF THESE LIMITATIONS APPLY TO YOUR PURCHASE OF THIS SOFTWARE.'





CONTENTS

1	About This Guide	9
1.1	Purpose	9
1.2	Assumed User Background	9
2	Introduction	11
2.1	Short Description	11
2.2	Application Areas	11
2.3	Functional Use	11
2.4	Acknowledgement	12
3	Basic Functionality	13
3.1	User Interface	13
3.1.1	Menu Bar	13
3.1.2	Tool Bar	14
3.1.3	Graphics Window	14
3.1.4	Property Tree	16
3.1.5	Property Pages	16
3.2	Layout	17
3.2.1	Managing figures	18
3.2.2	Output	19
3.2.3	Animation	19
3.3	2D Figures	20
3.3.1	Images	20
3.3.2	Text	21
3.3.3	Clock	21
3.3.4	Legend	21
3.4	Scenes	21
3.4.1	Data formats	21
3.4.2	Graphical Objects	24
3.4.3	Managing data files	26
3.4.4	View	26
4	Property Pages	29
4.1	Animation	29
4.1.1	Non-synchronized mode	29
4.1.2	Synchronized mode	29
4.2	Clock	30
4.3	Contour	31
4.4	Data	32



4.5	Figure	33
4.6	File	34
4.7	Fill	35
4.8	Flight Path	35
4.8.1	Definition of parameters	36
4.8.2	Control points	37
4.8.3	Load and save flight path	38
4.8.4	Rendering flight path	39
4.9	Image (2D Figure)	40
4.10	Image (Draped)	41
4.10.1	Image file formats	42
4.10.2	DHI world file	42
4.10.3	Creating georeferenced image	43
4.11	Image (Output)	43
4.12	Legend	44
4.13	Lighting	45
4.14	Movie	46
4.15	Object	47
4.15.1	3D solid	48
4.16	Objects	50
4.17	Palette	51
4.17.1	Palette color	52
4.18	Preferences	53
4.18.1	World box	55
4.19	Print	55
4.20	Projection	55
4.21	Slice	56
4.21.1	Horizontal slice	56
4.21.2	Vertical slice	57
4.22	Solids	58
4.22.1	Definition of solids	58
4.23	Surface	60
4.24	Symbol	61
4.25	Text	62
4.26	Trajectory	63
4.26.1	Source file	65
4.27	View	65
4.27.1	Definition of Parameters	66
4.27.2	Modifying view parameters	67
4.27.3	Saving/Loading view parameters	69
4.27.4	View history	69
5	Examples	71
5.1	General	71
5.2	Visualisation of Model Area	72
5.2.1	Description of data	72



5.2.2	How to start MIKE Animator Plus	73
5.2.3	Load data file	74
5.2.4	Select item to display	75
5.2.5	Views of model areas in MIKE Animator	77
5.2.6	Transformation of coordinates	80
5.3	Creation of Animation	80
5.3.1	Open MIKE Animator Plus	80
5.3.2	Load data	80
5.3.3	Adjust view properties	81
5.3.4	Adjust scene properties	83
5.3.5	Create a flight path	84
5.3.6	Record a movie	86
5.4	Combining Elements in Layout	87
5.4.1	Open MIKE Animator Plus	88
5.4.2	Load data	88
5.4.3	Add 2D objects	90
5.4.4	Show animation	93
5.5	Image Draping	94
5.5.1	Open MIKE Animator Plus	94
5.5.2	Load bathymetry data	94
5.5.3	Load georeferenced image	95
5.5.4	Adjust draping	96
5.6	Basic Solids	99
5.6.1	Open MIKE Animator Plus	100
5.6.2	Load bathymetry data	100
5.6.3	Load solid	101
5.6.4	Solids in installation	103
5.6.5	Rotating solid	104
5.7	Using Solids	104
5.7.1	Open MIKE Animator Plus	104
5.7.2	Evaluate 3D solid design	104
5.7.3	Load modelling results in new scene	105
5.7.4	Load 3D solid into existing scene	106
5.7.5	Position 3D solid for initial time step	107
5.7.6	Define trajectory for 3D solid	110
5.7.7	Import flight path	112
5.8	Displaying particles	114
5.8.1	Open MIKE Animator Plus	114
5.8.2	Load dfs results into new scene	115
5.8.3	Load particles into existing scene	115
5.8.4	Animate particles	116
5.8.5	Modify symbol layout	117
6	Quick-Guide	121
6.1	How to select file and display file item	121
6.2	How to control display properties	123
6.2.1	Background and scaling	124
6.2.2	Surface	125



6.2.3	Palette	126
6.2.4	Contour	127
6.2.5	World box	128
6.3	How to add 2D figures	129
6.3.1	Text	129
6.3.2	Legend	130
6.3.3	2D Image	131
6.4	How to drape image on surface	133
6.5	How to visualise waves	137
6.5.1	Bathymetry	138
6.5.2	Waves	139
6.5.3	Rollers	141
6.6	How to animate time series data	144
6.6.1	Clock	145
6.7	How to record a movie	147
6.8	How to show flow arrows	149
6.8.1	Bathymetry	149
6.8.2	Current velocity	150
6.8.3	Modifying symbol	151
6.9	How to show results from 3D dfs files	152
6.9.1	Bathymetry	153
6.9.2	Salinity	154
6.9.3	Type of layers	155
6.10	How to visualise dynamic bed level	159
6.10.1	Bathymetry	159
6.10.2	Animation	162
6.10.3	Surface elevation	163
6.10.4	Flow pattern	164
6.10.5	Current speed mapped to water level	165
6.11	How to add and control solids	166
6.11.1	Bathymetry	166
6.11.2	Solid	168
6.12	Trouble shooting	172
6.12.1	Gaps in surface	172
Index	173



1 About This Guide

1.1 Purpose

The main purpose of this User Guide is to get you started in the use of MIKE Animator Plus with emphasis on the basic features and usage of the fully Windows Integrated Graphical User Interface of MIKE Animator Plus. Additionally, a number of examples are included with the aim of introducing MIKE Animator Plus to users with no or very little experience with MIKE Animator Plus and guide them through the setup and production of animations.

This User Guide is complemented by the Online Help.

1.2 Assumed User Background

It is assumed that the user has a basic knowledge about the MIKE Zero modelling system, especially MIKE 21. The user should know about the file types that accompany numerical modelling with MIKE Zero modules, such as bathymetries, flow- and wave fields, concentration, etc.

Although MIKE Animator Plus has been carefully designed with emphasis on a logical and user-friendly interface, common sense is always needed in any practical application.

In this case, “common sense” means a knowledge which is sufficient for you to be able to select which data that should be displayed and how the data can be presented the best way.





2 Introduction

2.1 Short Description

MIKE Animator Plus is a professional 3D video-generating tool for presentation of results from water modelling applications.

With MIKE Animator Plus it is possible to work with result data from the MIKE Powered by DHI products MIKE 21, MIKE 3 and MIKE SHE.

MIKE Animator Plus allows you to view model areas and simulation results in a 3D environment, which gives an exceptional opportunity to communicate complex scientific data sets between the modelling specialist and the client.

In addition, being a Windows-based product; it is easy to learn and use. This makes it a unique presentation tool, and your animations can easily be exported to standard presentation tools such as for example Power-Point. MIKE Animator Plus is a vehicle for adding your own personal touch to project presentations – you can be the pilot “flying the model” while acting as a project guide.

2.2 Application Areas

MIKE Animator Plus is an ideal tool for:

- Immersive visualization of spatial data along with numerical model results
- Synchronous display of different data sets for comparison and validation
- Production of 3D images and animations of the virtual environment for presentation

These features allow the user to quickly detect invalid data, errors, or numerical instabilities in a simulation, as well as observe complex interactions of various phenomena in an intuitive manner. Presentation of simulation results to laypeople is also greatly enhanced since the animations look similar to the real physical processes.

2.3 Functional Use

The graphical user interface presents you with a single document on which you can place figures, similar to a page layout in presentation software. Figures on this Layout may contain interactive 3D scenes containing spatial/temporal data, or they may contain 2D overlays such as text, images, clocks, or color legends.



For data in a Scene figure, geometric configurations supported for spatial/temporal data include points, lines, meshes, and rasters. Volumetric configurations supported include fixed-, and sigma-spaced vertical axes. Typical data sources are output data from MIKE 21 & MIKE 3 simulations.

2.4 Acknowledgement

MIKE Animator Plus is a MIKE Powered by DHI software product jointly developed by Baird & Associates Coastal Engineers and DHI.



3 Basic Functionality

The information provided in the present chapter gives an overall introduction to the user interface and functionality of MIKE Animator Plus.

More detailed information regarding individual topics are given with the related Property Pages (p. 29).

3.1 User Interface

The overall user interface is divided into 5 sections that each contains a specific functionality as shown in Figure 3.1:

- Menu Bar
- Tool Bar
- Graphics Window
- Property Tree
- Property Pages

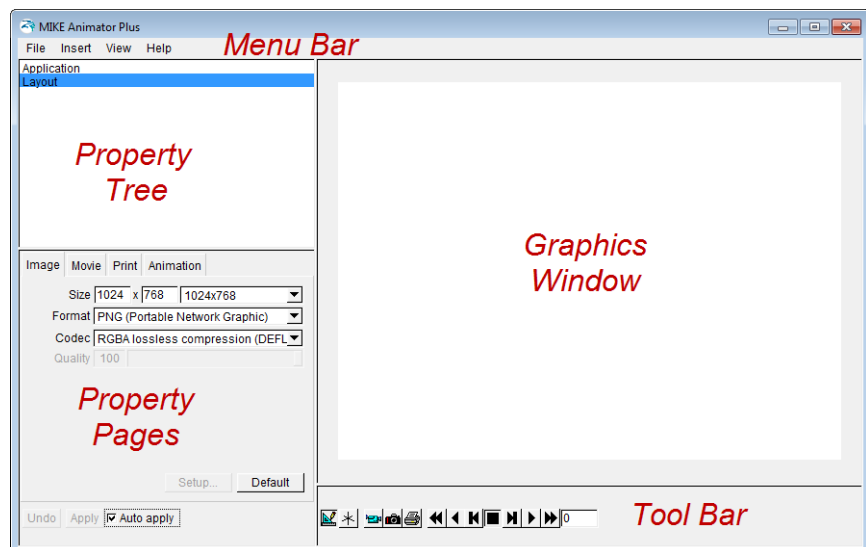

Figure 3.1 Definition of areas in overall user interface

3.1.1 Menu Bar

The Menu bar provides access to a fixed set of overall program functions, as well as dynamic, context-sensitive entries. The majority of program menus are context-sensitive right-click menus accessed from other areas of the user interface.



Edit Unit Base Group

From the File->Options entry you may access the Edit Unit Base Group dialog.

MIKE Animator Plus includes full support for user selected units (including imperial units). The Edit Unit Base Group functionality enables the user to specify the preferred unit to any type of item.

The EUM system is constructed in such a way that the various units are hooked up to the specific eum types e.g. water level can handle meter, ft, US feet etc. Within each eum type it is possible to convert between the various units. Unfortunately the system cannot work with having types as undefined. Hence it is necessary to associate one or more eum types with a certain parameter.

This is typically not a problem as the result dfs files will automatically hold valid eum types, but it should be considered when creating dfs files manually. E.g. for a trajectory dfs0 file the eum types must be defined as follows: the (X,Y)-coordinate as *Geographical coordinate*, the Z-coordinate as *Item geometry 3-dimensional* and the rotation angles as *Angles*.

3.1.2 Tool Bar

The Tool Bar provides quick access to the most common program functions related to working with the Graphics Window.

3.1.3 Graphics Window

The Graphics Window operates in two modes: Layout and Scene.

Layout Mode is for viewing and editing the Layout, and Scene Mode is for viewing and editing the current Scene figure. Throughout this document, the Graphics window will be referred to as either the Layout Window or the Scene Window, depending upon the selected mode.

Note: When deleting a current Scene shown in Scene Mode the Scene window will become blank. To view another scene figure double click the entry in the Property Tree.

Layout Window



To switch the Graphics Window to Layout Mode, select it from the View Menu on the Menu Bar, or click the Layout Mode button on the Tool Bar.

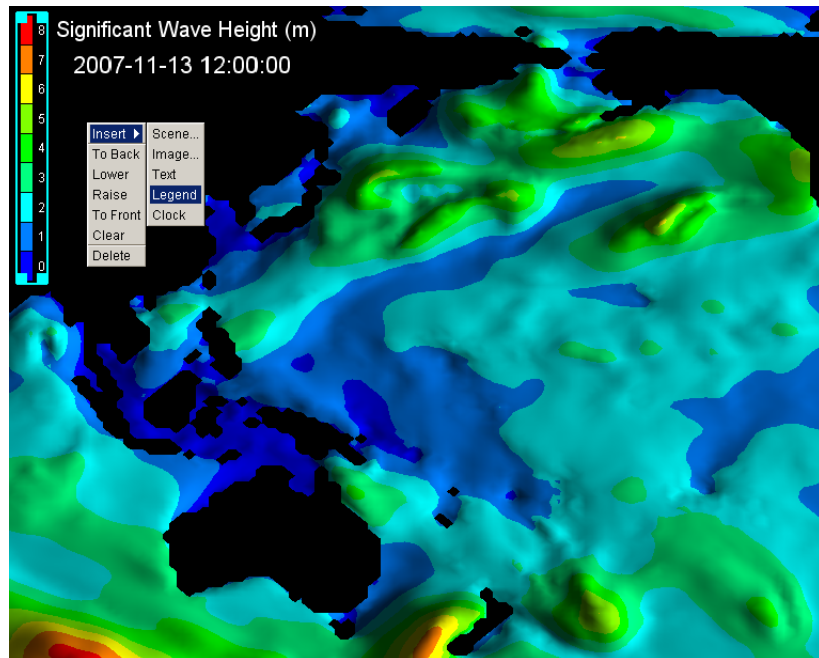

Figure 3.2 Example of Layout Window mode

Scene Window



To switch the Graphics Window to Scene Mode, select it from the View Menu on the Menu bar, or click the Scene Mode button on the Tool bar.

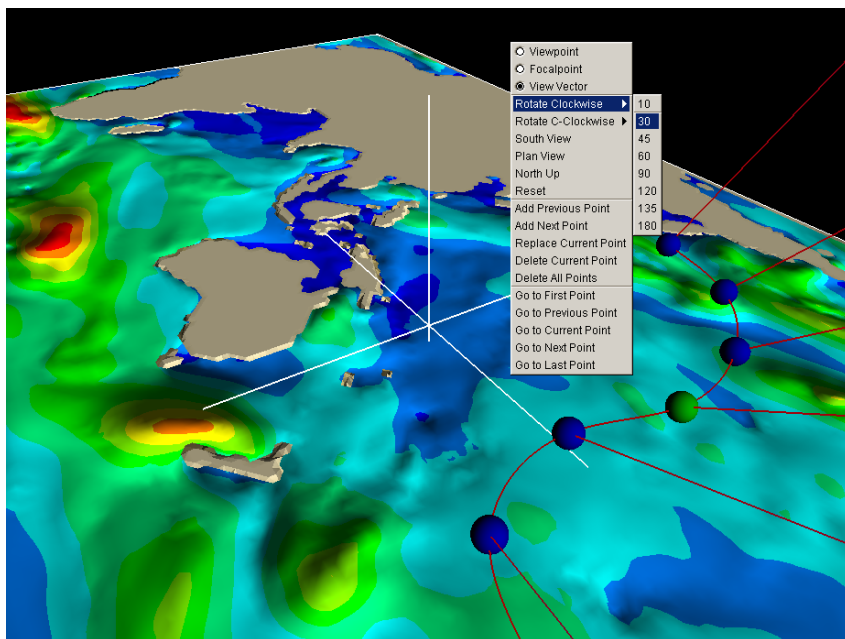

Figure 3.3 Example of Scene Window mode

3.1.4 Property Tree

The Property Tree and Property Pages work in tandem (see Figure 3.1).

The Property Tree contains a list of all the elements that make up the Layout, presented in an hierarchical format with expandable branches. Selecting a list entry will display the corresponding property page.

3.1.5 Property Pages

The Property Tree and Property Pages work in tandem (see Figure 3.1).

The Property page contains the input properties for the specific element that makes up part of the Layout. Selecting a property page will automatically display the corresponding list entry. Each tab menu is duplicated as a submenu on the Property Tree menu.

Context-sensitive menus are available by right-clicking on an item in the tree, or on the tab of a property page, as shown in Figure 4.2.

Changes made to property pages can be configured to take effect either manually, using the Apply and Undo buttons, or automatically, using the Auto Apply checkbox. The Undo function discards all changes made for all pages since the last time changes were applied.

See also Property Pages (p. 29).

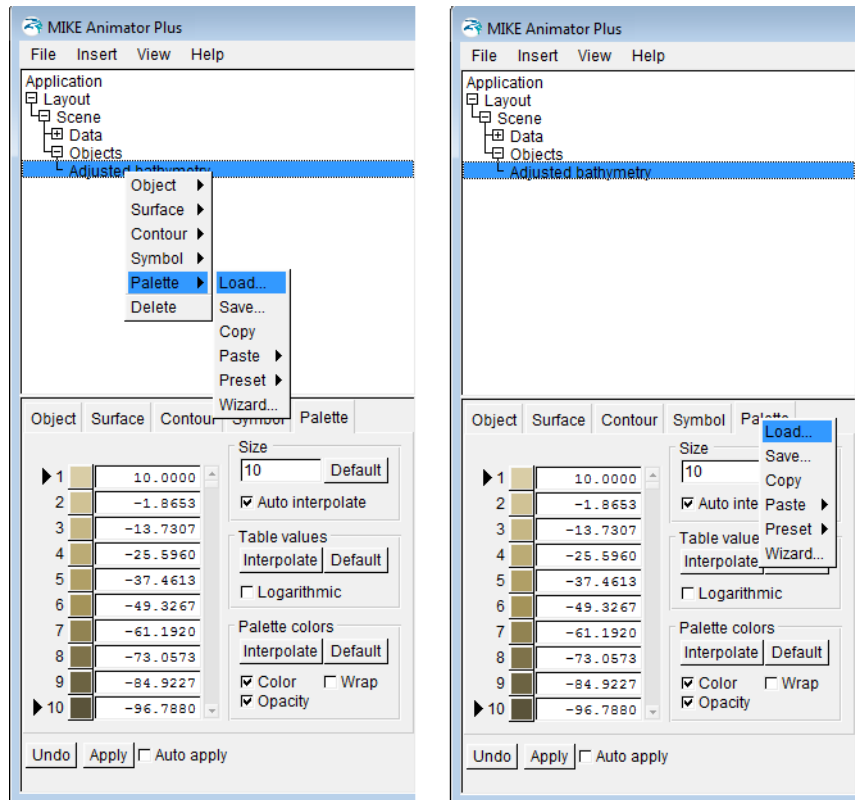

Figure 3.4 Example of right-click context sensitive menus using entry from property tree (left) and property page (right), respectively.

3.2 Layout

The Layout window shows a collection of 2D Figures and Scenes on a page, which are added using the Insert menu from the Menu Bar. This may also be done from a submenu of the File menu on the Menu bar, the context menu on the Layout item in the Property Tree or the context menu in the Layout Window.

Layouts may also be imported and exported to file via the Open, Save, and Save As selections of the File menu on the Menu Bar, and from the context menu on the Layout item in the Property Tree.

All 2D Figures and Scenes (3D figures) have a common Figure page and Fill property page. Additional settings for the individual figure or scene may be defined using other Property Pages.



3.2.1 Managing figures

Selecting figures

Figures are selected in the Layout Window by left-clicking with the mouse. A selected figure will be illustrated by an outline and small square sizing handles at each corner.

For multiple figure selection hold down the <CTRL> key and use the left-mouse to select or de-select figures. Multiple selections can also be done by holding down the <SHIFT> key and dragging the left-mouse to outline an area that completely contains the desired figures.

To deselect all figures, select Clear from the context menu in the Layout Window.

Moving and sizing figures

To move a selection, press and hold down the left-mouse inside the selection area and drag the object to reposition. To size the figure press and hold down the left-mouse over the small square sizing handles at a corner and stretch the object to the desired size.

For multiple figure sizing and positioning you can size or position the grouped item as described for single figures above.

Layering figures

Figures are also layered on the page. The layering is controlled by the To Back, Lower, Raise, and To Front selections from the right-click menu in the Layout Window. The selected figures can also be lowered and raised using the scroll wheel in the Layout Window, if your mouse has one.

Deleting figures

To delete the selected figures, select Delete from the context menu in the Layout Window. To delete any individual figure, whether selected or not, select Delete from context menu for the figure entry in the Property Tree.



3.2.2 Output

Output of the Layout can be to either an Image file, a Movie file, or a Printer. These functions are invoked from the File menu of the Menu Bar, or from buttons on the Tool Bar:



Snapshot creates an Image (Output) file of the current frame of the Layout



Record creates a Movie file of the Layout Animation



Print sends current frame of the Layout to a printer

Each of these three output methods has a preview mode which is selected from the view menu of the Menu Bar, as well as having their respective property pages.

3.2.3 Animation

Dynamic objects have data frames which can be displayed in succession. In addition to Graphical Objects, the view may also be animated as a Flight Path. For each File that you wish to animate, you must enable the Animate checkbox on its corresponding property page.

Animation is performed through controls on the Tool Bar. It has buttons for Rewind, Play Backward, Back-step, Stop, Forward-step, Play, and Wind. There is also a frame counter which allows you to seek directly to a particular frame number.



Figure 3.5 Buttons for Animation on Tool Bar

See also *Animation* (p. 29).

Non-Synchronized Animation

Non-synchronized mode is the default, and is the preferred option for data without a fully specified time dimension, or when all objects share the same temporal component.

Non-synchronized mode does not consider the time dimension, as it is frame-based. When play is pressed, all objects that are set to animate will advance one frame at a time until they reach the end. The animation stops when all objects have run out of temporal data. If you are viewing objects with different output frequencies, then the frames displayed will not correspond to the same point in time.



Synchronized Animation

Synchronized mode is only available if all dynamic objects have a fully specified time dimension. The animation is specified by a Start Time, End Time and TimeStep.

The animation must occur during the time period encompassing all dynamic objects. The animation advances at a regular interval which is independent of the data. At each animation frame, object frames are displayed which are closest to the animation timestamp.

3.3 2D Figures

You can insert four types of 2D figures from the Menu bar:

- Images
- Text
- Clock
- Legend

All 2D Figures have a common Figure page and Fill property page. Additional properties may be defined dependent on the type of figure.

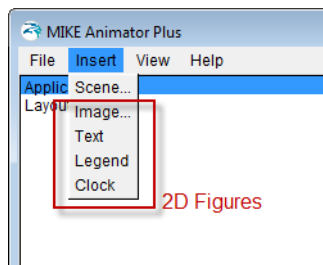

3.3.1 Images

Image figures are 2D figures. A selection of common image file formats are supported, and full alpha-channel transparency is enabled for those formats that support it.

When you insert an Image figure, you are prompted to select the image file via a file selection dialog. If you decide to cancel the dialog, an empty Image figure is added to the Layout. This is a convenient way to display a simple box in the Layout. An image can subsequently be added or replaced by selecting Load data from the right-click menu for the figure entry in the Property Tree.

See also Image (2D Figure) (p. 40).



3.3.2 Text

Text figures are 2D labels that can be used for e.g. descriptive titles in the layout.

See also Text (*p. 62*).

3.3.3 Clock

Clock figures are 2D labels representing a digital time stamp. It may be associated with one of the scenes in the Layout and e.g. used to show the development of time during an animation.

See also Clock (*p. 30*).

3.3.4 Legend

Legend figures are 2D color bars. The palette is associated with a geographical object within a scene figure.

See also Legend (*p. 44*)

3.4 Scenes

Scene figures are the main focus of MIKE Animator Plus. They are 3D worlds populated with spatial/temporal data which can be navigated using the Scene Window.

The 3D world is referred to as the data-space. The data-space is populated by loading external files to be used as data sources for Graphical Objects.

3.4.1 Data formats

The spatial data that is to be loaded and used as a data source may have one of the following formats:

- 3D studio solids (3ds format)
- dfs2 (e.g. MIKE 21 data or MIKE SHE data)
- dfs3 (e.g. MIKE 3 or MIKE SHE data)
- dfsu (MIKE flexible mesh data)
- mesh (MIKE flexible mesh bathymetry)
- Georeferenced images (image with DHI world file)
- xml (MIKE particles)



Graphical Objects are created from variables contained in data files loaded for a Scene. The menu of available object types is dependent entirely upon the nature of the variable and its base geometry.

The File property dialog will show the available items of a selected data file. A double-click on a variable in the list will create the default object type for the given type of item. By right-clicking a variable a context menu appears with a list of available object types.

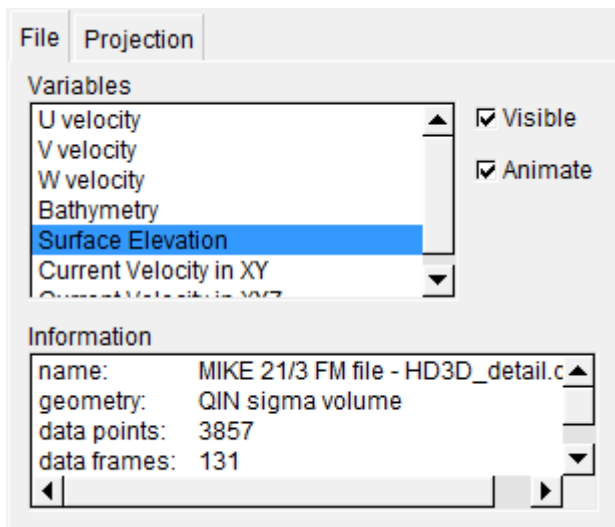

Figure 3.6 Example of File property dialog showing available variables in a file

3D studio solids

A 3D studio solid shows a 3D object, e.g. a ship, in a user-defined location in the domain.

MIKE Animator Plus contains a few simple pre-defined solids files to use, however there are places on the internet where a large variety of simple and advanced solids are available and can be downloaded for free. The solids shown in Figure 3.7 are supplied with the examples in the installation.

NOTE: The present version only supports the file format .3ds.

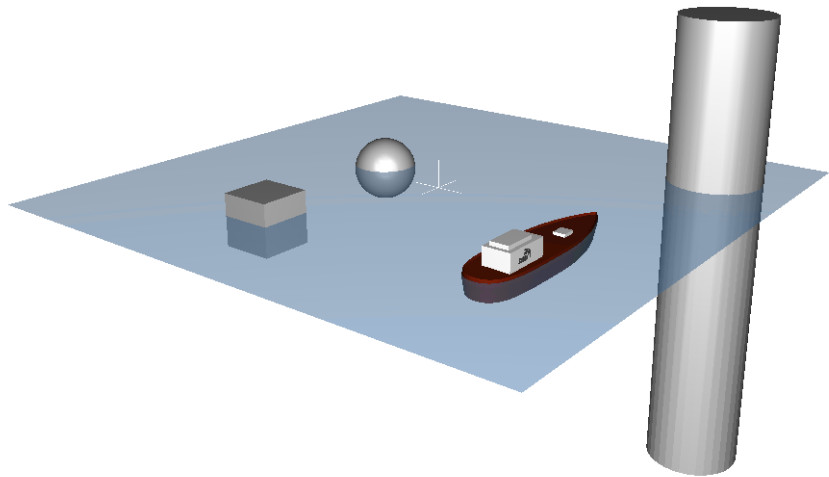

Figure 3.7 Example of solids supplied with the MIKE Animator Plus installation.

xml (MIKE particles)

A xml particle file contains spatial and temporal information about the particles. However this cannot be used to initialize the domain and temporal resolution for the scene. Hence you should only add an xml file to an existing scene.

NOTE: In the present version only the first particle class in the xml particle file is read from the file.

A properties of a particle can be described by any number of variables defined by any item type in the xml file. However, the first 3 variables must be the spatial information given in correct order and using the specific item types as defined in Table 3.1.

Table 3.1 Item description in xml file file

Item number	Description	Item type
1	X-coordinate	Geographical coordinate
2	Y-coordinate	Geographical coordinate
3	Z-coordinate	Water depth
4...

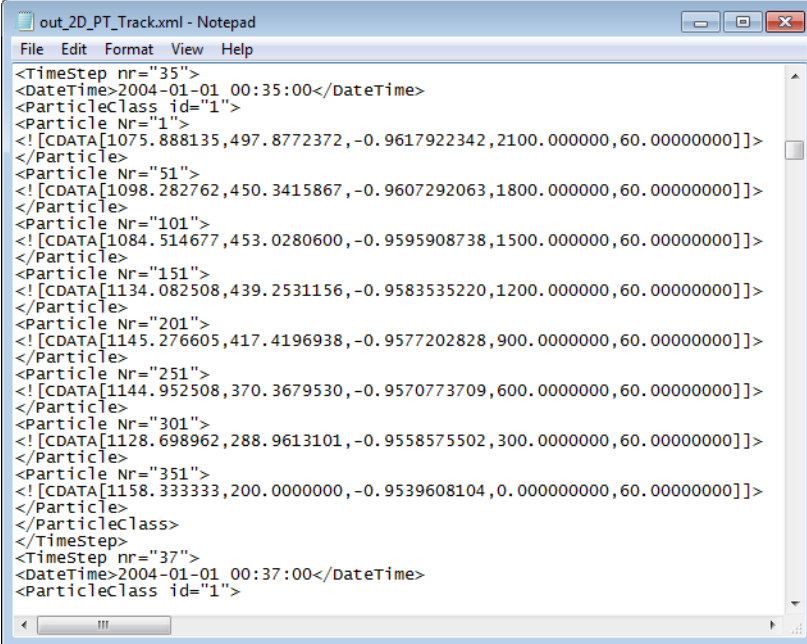

```
out_2D_PT_Track.xml - Notepad
File Edit Format View Help
<TimeStep nr="35">
<DateTime>2004-01-01 00:35:00</DateTime>
<ParticleClass id="1">
<Particle Nr="1">
<![CDATA[1075.888135,497.8772372,-0.9617922342,2100.000000,60.00000000]]>
</Particle>
<Particle Nr="51">
<![CDATA[1098.282762,450.3415867,-0.9607292063,1800.000000,60.00000000]]>
</Particle>
<Particle Nr="101">
<![CDATA[1084.514677,453.0280600,-0.9595908738,1500.000000,60.00000000]]>
</Particle>
<Particle Nr="151">
<![CDATA[1134.082508,439.2531156,-0.9583535220,1200.000000,60.00000000]]>
</Particle>
<Particle Nr="201">
<![CDATA[1145.276605,417.4196938,-0.9577202828,900.000000,60.00000000]]>
</Particle>
<Particle Nr="251">
<![CDATA[1144.952508,370.3679530,-0.9570773709,600.000000,60.00000000]]>
</Particle>
<Particle Nr="301">
<![CDATA[1128.698962,288.9613101,-0.9558575502,300.000000,60.00000000]]>
</Particle>
<Particle Nr="351">
<![CDATA[1158.333333,200.000000,-0.9539608104,0.00000000,60.00000000]]>
</Particle>
</ParticleClass>
</TimeStep>
<TimeStep nr="37">
<DateTime>2004-01-01 00:37:00</DateTime>
<ParticleClass id="1">
```

Figure 3.8 Example of XML particle file as shown in Notepad.

3.4.2 Graphical Objects

Graphical Objects are created from variables contained in data files loaded for a Scene. The menu of available object types is dependent entirely upon the nature of the variable and its base geometry.

The full list of available object types is:

- Points
- Lines
- Surfaces
- Layer Slices
- Horizontal Slices
- Vertical Slices
- Isosurfaces
- Ellipses
- Solids

The display of each graphical object can be defined via a number of relevant Property Pages.



The File property dialog will show the available items of a selected data file. A double-click on a variable in the list will create the default object type for the selected Item type. By right-clicking a variable a context menu appears with a list of available object types for the given item.

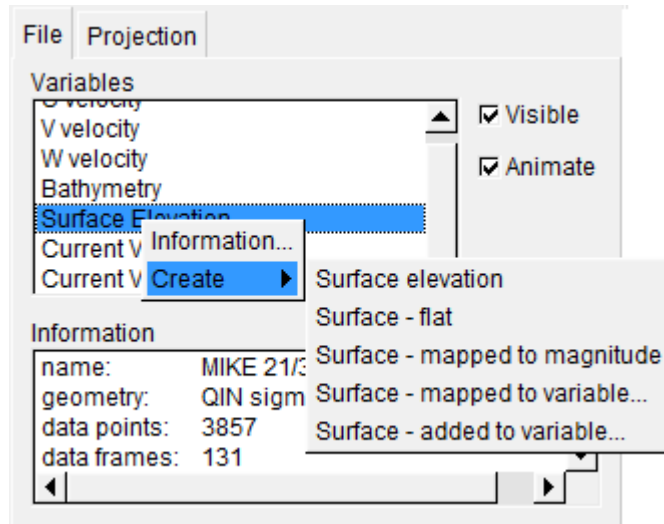

Figure 3.9 Example of available object types in context menu

Item type

Most dfs data file items will per default be displayed by a flat surface and using the rainbow palette. However, some commonly used item types are recognised by the program and per default associated with a special object type and palette. Table 3.2 contains a list of commonly used item types and the associated default display.

Table 3.2 Default object type display for selected item types

Item type	Object type	Comment
Bathymetry	Land surface	Palette: Land
Surface elevation	Water surface	Palette: Water
Current Velocity	Fluid velocity	Derived vector, Symbol: Arrow
Current Velocity in XY(Z)	Layered slice	Derived vector, Symbol: Arrow
Topography	Land surface	Palette: Land



3.4.3 Managing data files

When you insert a Scene figure, you are prompted to select the data file via a file selection dialog. If you decide to cancel the dialog, an empty Scene figure is added to the Layout. Any number of subsequent data files may be added by selecting **Load data** from context menu for the figure entry in the Property Tree.

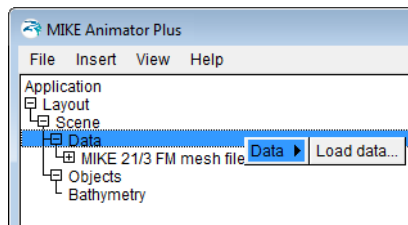

Figure 3.10 Loading additional data into existing scene

A scene figure, and all files and objects created from it can be deleted by selecting **Delete** from the context menu for the figure entry in the Property Tree.

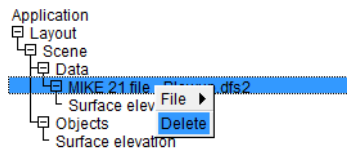

Figure 3.11 Deleting data from context menu

Just as figures have a drawing order in the Layout, so do the objects in an individual scene. This becomes important when using transparency and anti-aliasing, since such objects need to be drawn last.

You can modify the drawing order from the Objects property page.

3.4.4 View

The View defines how you look at the data-space for the individual scene. There are some basic Preferences that you can utilize that may help you navigate in the data-space, e.g. a world-box and crosshairs.

For basic navigation in MIKE Animator Plus you will be concerned with moving two points around in space:

- Viewpoint - the location from which you are looking



- Focalpoint - the location at which you are looking

Moving the Viewpoint is analogous to moving through the landscape while always looking at the same spot, whereas moving the Focalpoint is analogous to turning your head to look at something else in the landscape while remaining in the same position. Figure 4.44 illustrates this from a 2D side view.

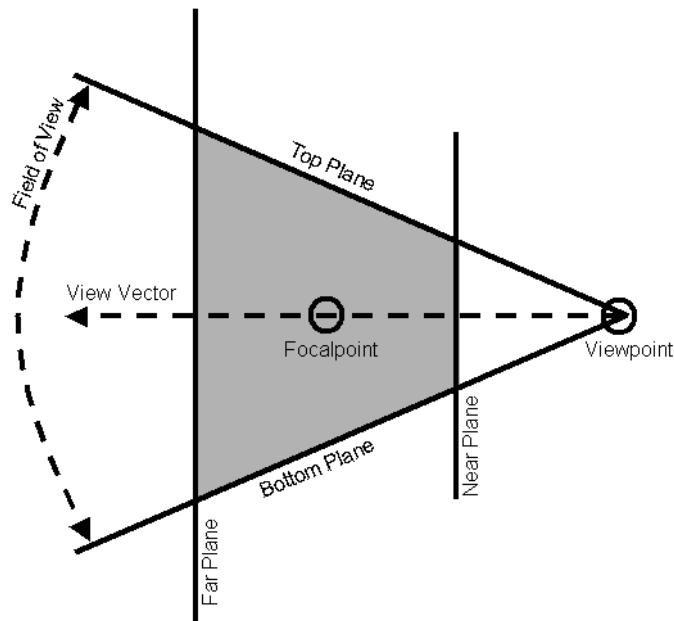

Figure 3.12 Illustration of view point and focal point

You may move the view point or focal point by setting the parameters in the View property page or by dragging the view point or focal point in the graphics window when it is in Scene mode.



To switch the Graphics Window to Scene Mode, select it from the View Menu on the Menu Bar, or click the Scene Mode button on the Tool Bar.

You can read more about View properties on page 65 and Preferences on page 53. Other view settings for the individual scene, such as Lighting or Flight Path can be specified by the relevant Property Pages in page 45 and page 35, respectively.





4 Property Pages

The following sections contains a description of the various property pages and related parameters, sorted in alphabetical order.

4.1 Animation

The Animation property page allows modification of the animation rate, duration, and the data frames displayed.

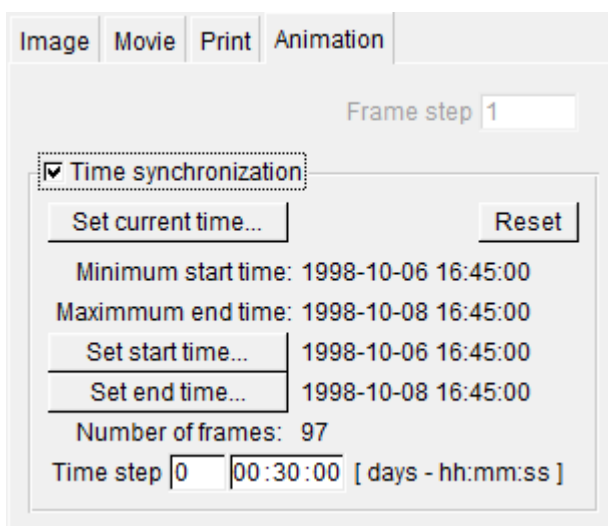

Figure 4.1 Animation properties dialog

The Time synchronization group controls how a synchronized animation mode is to be implemented for multiple figures in the Layout.

4.1.1 Non-synchronized mode

For a non-synchronized animation, a Frame Step value is available to play every n^{th} frame.

4.1.2 Synchronized mode

For a synchronized animation you must specify the Start time, End time and Time step of the animation.

Information based on the input is derived and displayed in the dialog:

- The Minimum start time displays the earliest possible valid time stamp of all the synchronized objects.



- The Maximum end time displays the latest possible valid time stamp of all the synchronized objects.
- The Number of frames displays the number of resulting animation frames calculated from:
$$\text{Frames} = 1 + (\text{End time} - \text{Start time}) / \text{Time step}$$

Start time

The Set start time button allows you to specify the timestamp of the first animation frame. The value must fall within the time period specified by the Minimum and Maximum time, and be less than or equal to that specified by the End button.

End time

The Set end time button allows you to specify the maximum timestamp for the last animation frame. The value must fall within the time period specified by the Minimum and Maximum time, and be greater than or equal to that specified by the Start button. The ending animation frame will not have a time stamp greater than that specified here.

Time step

The Time step input allows you to specify the interval between animation frames.

Reset

The Reset button recalculates the data time domain plus the default Time step, then applies the resulting values to the page.

4.2 Clock

Clock figures are 2D labels representing the digital timestamp of some temporal aspect of the Layout in standard ISO date and time format.

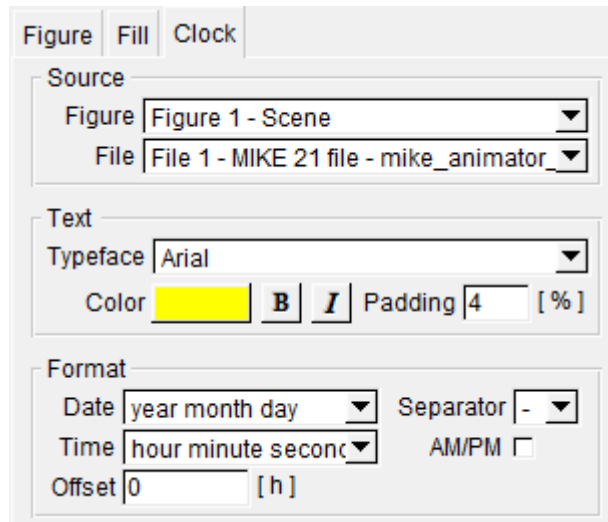

Figure 4.2 Clock property dialog

- The Source droplists allow you to bind the Clock to the temporal data of the entire Layout, and individual Scene figure, or an individual data file in a Scene.
- The Text controls allow you to change attributes of the font in the same manner as a Text figure.

The UTC offset value allows you to adjust timestamps to any local time zone.

4.3 Contour

Object types which can be displayed as a surface will have a Contour property page.

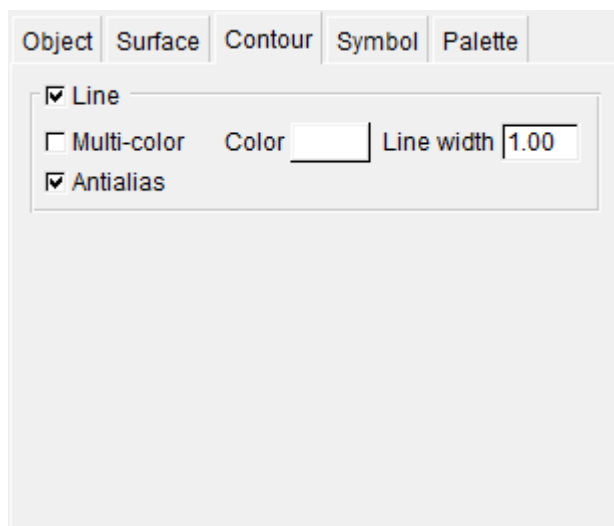

Figure 4.3 Contour property dialog

The Contour property page controls the display of contour lines for the surface.

In case Multi-color is un-checked the color of the contour lines is defined by the Color in the menu, otherwise the contour colors are a lighter shade of the Palette color for the given contour value.

4.4 Data

All files included within a scene are listed in the Data property dialog.

You can enable or disable the display of all graphical objects from an individual data file using this dialog.

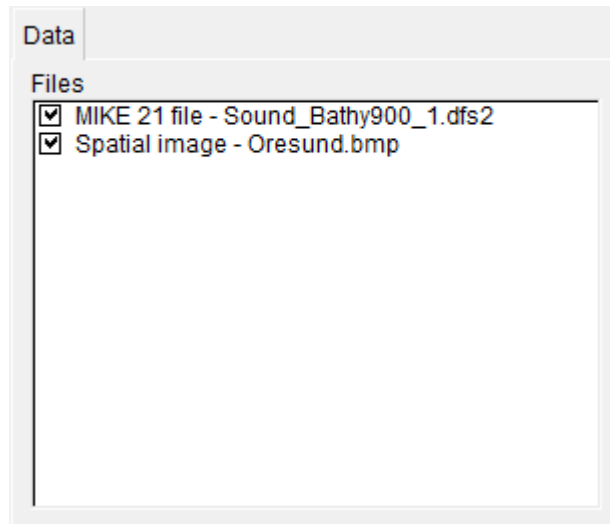

Figure 4.4 Data property dialog

4.5 Figure

The Figure properties control the basic attributes common for most figures such as visibility, size, and resizing behavior as well as the option for dynamic display.

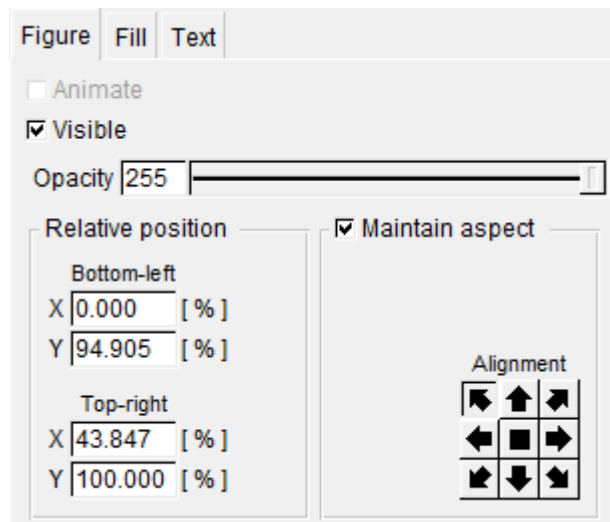

Figure 4.5 Figure property dialog

- The Visible checkbox will hide or show a figure



- The Animate checkbox determines whether figures with temporal data can be animated
- The Opacity controls the overall transparency setting for 2D Figures
- The Relative coordinates denote the position and size of the figure in the Layout.
- The Maintain aspect controls determine whether 2D figures are adjusted to maintain aspect when resized and the Alignment determines to which edge or corner the figure will be anchored.

4.6 File

The File property dialog will show the available items of a selected data file. A double-click on a variable in the list will create the default object type for the given type of item. By right-clicking a variable a context menu appears with a list of available object types.

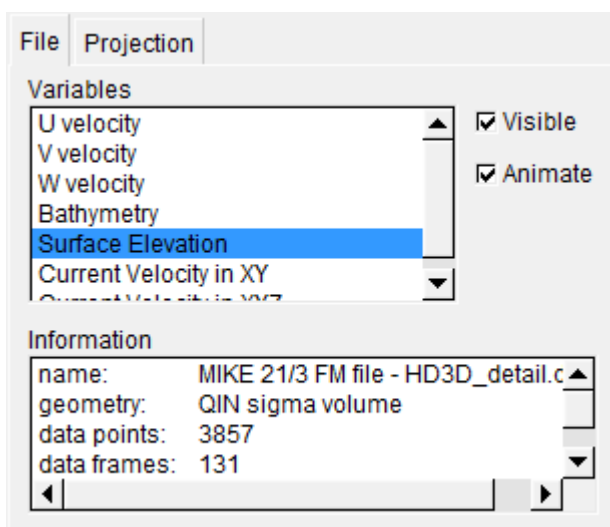

Figure 4.6 File property dialog

The animation for all the objects created from a file can be controlled from the context menu or the Figure property dialog (see page 33).

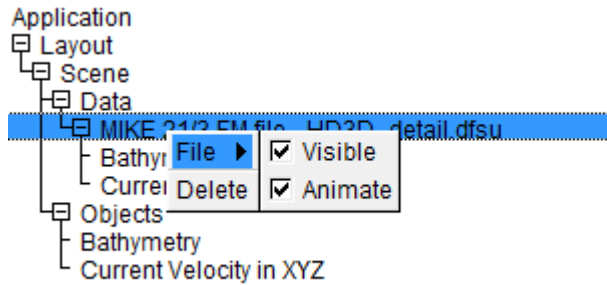

Figure 4.7 Context menu for data file

4.7 Fill

Every figure type has a background Fill property page.

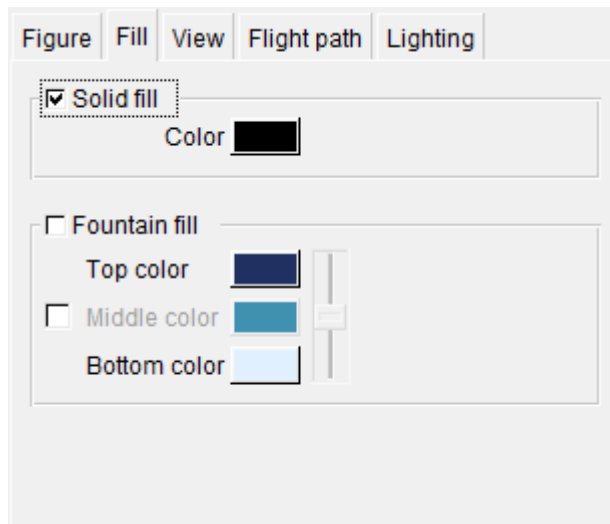

Figure 4.8 Fill property dialog

- The Solid fill property is a mono-colored background.
- Fountain fill is a variable blend of 2 or 3 colors.

Both of the 2 fill types can be enabled concurrently, and are rendered in the order that they appear on the page.

4.8 Flight Path

A flight path is defined by storing views that are used as control points for interpolating curves through the data-space in a scene. One curve represents



the path of the Viewpoint and the other represents the path of the Focalpoint. Flight paths allow you to animate the view.

The flight path can be rendered using a variety of different attributes, which are controlled from the Flight path property page.

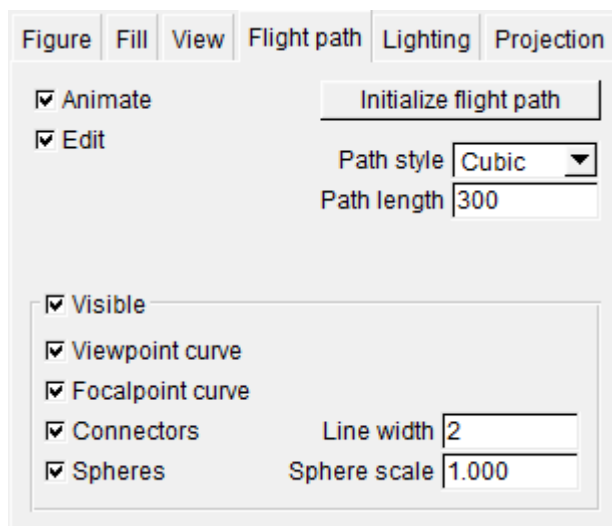

Figure 4.9 Flight path property dialog



The Edit flight path button on the Tool Bar is available when the Scene Window is shown. When the button is in the down position, the flight path is in edit mode. If there is no current flight path, then a default flight path is created.

4.8.1 Definition of parameters

A control point describes a view defined by a Viewpoint and a Focalpoint on the flight path.

The current control point is highlighted in green in Figure 4.10.

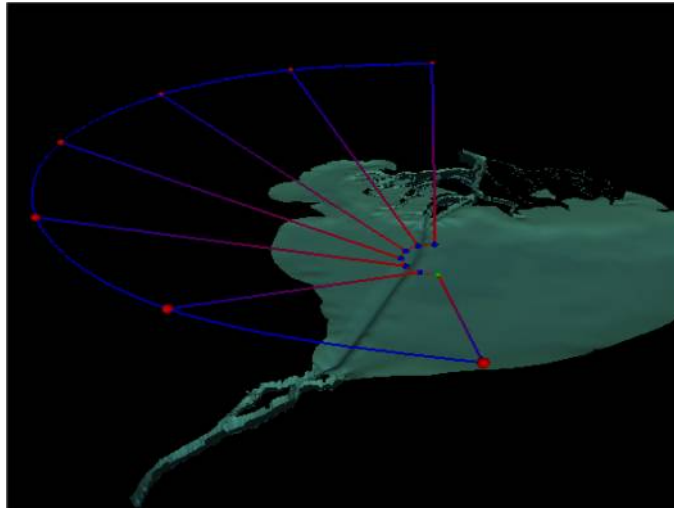

Figure 4.10 Example of flight path in Scene Window

4.8.2 Control points

Managing control points

When in flight path edit mode, several functions are appended to the context menu for the Scene Window.

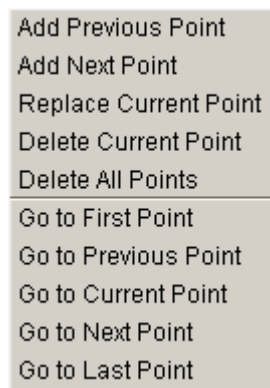

Figure 4.11 Context menu for flight path edit mode

Add

To insert Control Points, adjust the view to the desired path starting Point and select either Add Previous Point or Add Next Point from the context menu. Whenever a new Point is added, it becomes the current control point. The current control point is highlighted in green. Subsequent additions will be inserted either before or after the current point.



You may also add additional points by a double-click while pointing to the desired location on the curve. To extend a curve, double-click beyond either end of curve.

Replace

The Replace Current Point function replaces the view associated with the current control point to that of the current view

Removing points

You may remove the current point by selecting Delete Current Point from the context menu, or simply pressing the <Delete> key. If the number of points drops below two, then the entire path will be cleared. To delete the entire path at once, select Delete All from the context menu.

Goto

The group of Go to [n] point selections on the context menu cause the current view to change to that of the current control point. This is most useful for cycling through the points to examine the views in succession.

The keyboard can also be used to navigate through the control points in exactly the same manner:

<Home>	→	go to first point
<End>	→	go to last point
<Page Up>	→	go to previous point
<Page Down>	→	go to next point

Moving control points

To edit the path in the Scene Window, left-click on a sphere to make it the current control point. The current control point is highlighted in green.

Using the left mouse button, click and drag the Control Point to the new desired position. As you move the control point, only its horizontal XY position changes. Holding down the <CTRL> key will constrain the movements to only change the Z (vertical) coordinate of a control point.

4.8.3 Load and save flight path

It is possible to load or save a flight path using the context menu appearing when right-clicking the tab in the property page.

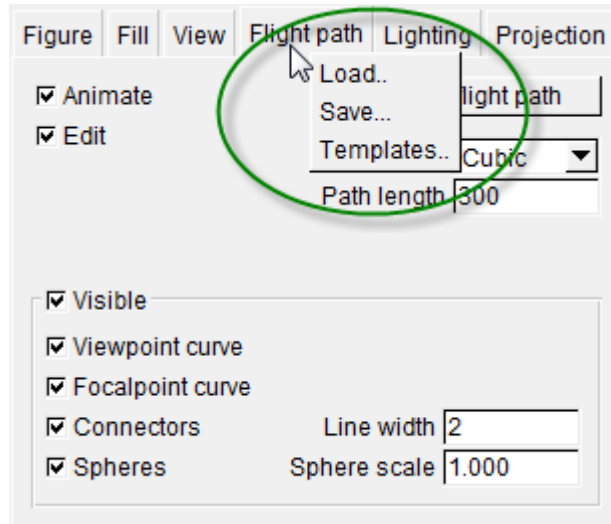

Figure 4.12 Accessing flight path files from context menu

A flight path can be loaded or saved using an ASCII file with a specific extension (*.fsp). The file contains values in nine columns, separated by spaces. Each line describes a given view by the control point:

- Columns 1-3 contain coordinates for the Viewpoint
- Columns 4-6 contain coordinates for the Focalpoint
- Columns 7-9 contain coordinates for the up-vector
(Presently this is fixed to 0 0 1 to only allow for a horizontal view)

4.8.4 Rendering flight path

The flight path can be rendered using a variety of different attributes, which are controlled from the Flight path property page shown in Figure 4.9.

The most important of these attributes is the Path length which controls the total number of steps or views that will be used in the flight path. More steps produces a smoother curve.

Flight speed

Adjusting the spacing between the camera control points will vary the speed of the flight through the scene. By clustering the spacing of camera control points it is possible to slow the camera's movement.

For example, with a starting flight path set to 1000 frames and 5 control points equally spaced (creating 4 equal segments), each segment is 250 frames, so the view will move at a constant speed, v , through the entire path (see Figure 4.13, left).



If the path is edited and a new control point is added exactly mid-way along the last segment, each segment would now represent 200 frames in the final animation, causing the camera to move slower through the last 2 segments (Figure 4.13, right).

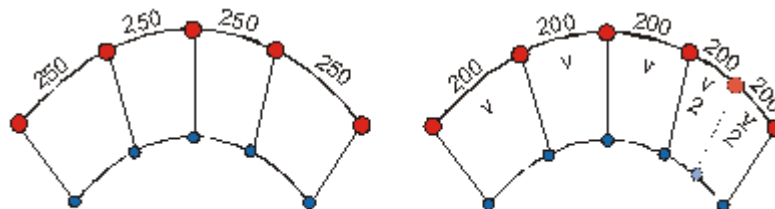

Figure 4.13 Example of flight speed along flight path
Left: Constant camera speed through all segments
Right: Slower camera speed through the last two segments

4.9 Image (2D Figure)

Image figures are 2D pictures. The only property specific to these is the Transparent color, which allow you to designate a transparent background for Image figures. A selection of common image file formats are supported, and full alpha-channel transparency is enabled for those formats that support it.

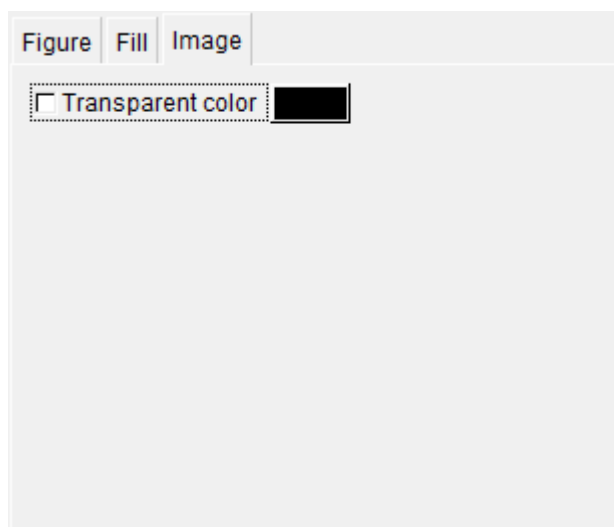

Figure 4.14 Property dialog for transparency of 2D image figure



4.10 Image (Draped)

A georeferenced image is defined by two files: an image file (e.g. jpg) and a corresponding DHI world file (e.g. jpgw). These together forms an orthoimage object.

The orthoimage can be draped onto any Surface in the scene. It is possible to limit the draping of the image to a certain vertical level of the surface by choosing non-uniform draping using a specified land value.

NOTE: It is only possible to relate an orthoimage object to one surface at a time. If you need to drape the image to several surfaces, you need to import the orthoimage object for each surface.

Object | Image

Visible Layer 0

Transparent color

Opacity 255

Drape to surface File 0 - Bathymetry ▼

Non-uniform draping

Drape to entire surface Land value 0.000

Drape to land only

Drape to basin only Flatten basin

Figure 4.15 Property dialog for rectified image

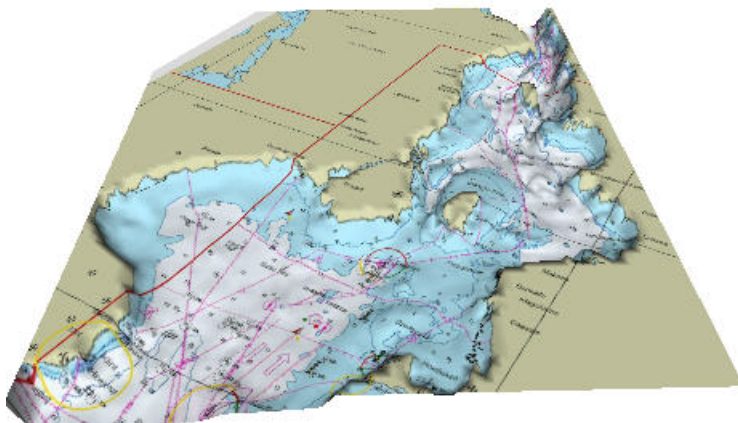

Figure 4.16 Example of image draping

4.10.1 Image file formats

The valid image formats for MIKE Animator Plus are as follows:

- BMP (Windows bitmap)
- JPEG/JPG (IJJ JFJF)
- PNG (Portable network graphic)
- TIFF/TIF (Tagged image file format)

4.10.2 DHI world file

The DHI world file must contain the coordinates of the lower left corner and the upper right corner, respectively, and a string describing the related map projection. An example is shown below.



```

// Created      : 2009-05-27 12:20:5
// DLL id       : C:\Program Files\DHI\2010\bin\pfs2004.dll
// PFS version  : May 25 2009 20:30:00

[MIKE_0_Graphical_Images]
[World_Coordinates]
  x0 = 305430
  y0 = 6121100
  x1 = 403900
  y1 = 6240150
  MapProjection = 'PROJCS["UTM-33",GEOGCS["Unused",DATUM["UTM 1
EndSect // World_Coordinates

EndSect // MIKE_0_Graphical_Images

```

Figure 4.17 Example of DHI world image file

Note: in case the map projection is missing from the DHI world file MIKE Animator Plus will assume that the world coordinates correspond to the same map projection as for the surface in the Scene.

4.10.3 Creating georeferenced image

You can create a georeferenced image for use in MIKE Animator Plus by first utilizing the Image Rectifier editor (available in a MIKE Zero installation) to rectify the image and find the coordinates for the lower and upper right corner and next utilizing the MIKE Zero Toolbox, File Converter utility Geo Referencing Image File to create a full DHI world file containing the map projection as well.

Note: It is possible to utilize the Geo Referencing Image File utility to create a DHI world file based on an existing ESRI world file.

4.11 Image (Output)

The Image property page for the Layout controls the size (width by height in pixels), and the file format for the output raster image.

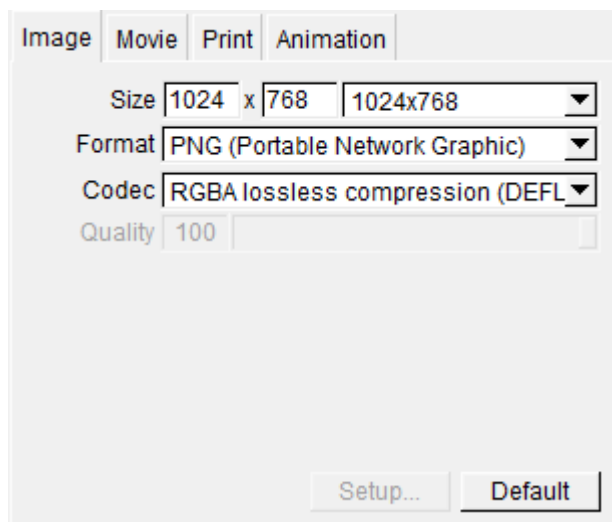

Figure 4.18 Raster property dialog

A selection of common image sizes is available in a droplist.

4.12 Legend

Legend figures are 2D color bars representing the palette of a graphical object in a Scene figure.

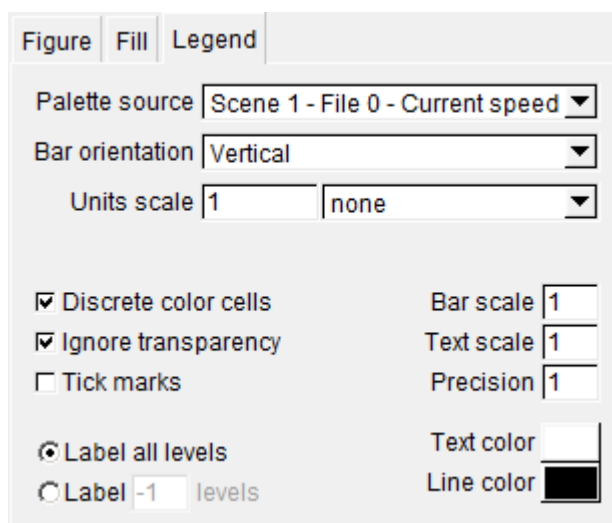
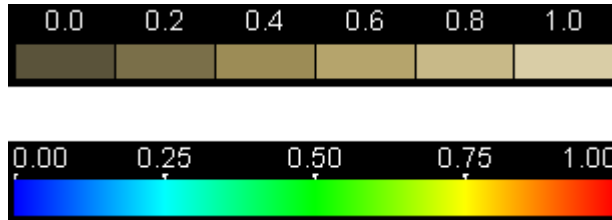

Figure 4.19 Legend property dialog

- The Palette source droplists allow you to bind the Legend to an object in a scene.



- The Bar orientation droplist allows you to choose either a horizontal or vertical bar.
- The Units scale controls allow you to modify the values displayed for the palette table.
- The Discrete color cells checkbox toggles between the display of separate colors and a continuous spectrum. Examples of the two types are shown below. Continuous spectra are useful for large palettes.



- The Ignore transparency checkbox toggles between using transparency from the palette and always drawing opaque colors.
- The Tick marks toggles arrowheads relating values to colors on the palette.
- The Bar width scale and Text scale values are simple adjustments to the size and shape of their respective elements.
- The Precision value controls the number of decimal places to display.
- The Text color button shows a color selection dialog. The color is also applied to tick marks.
- The Line color buttons shows a color selection dialog. The color is used for cell outlines of a discrete color bar.
- The Label all levels and Label [n] levels radio buttons and input allow you to display only a subset of the values associated with a palette. This is useful for large palettes.

NOTE: The layout of the legend is linked to the Figure property dialog. Modifying the layout of the legend to user-specific needs may be easier if 'Maintain aspect' is un-selected in that dialog.

4.13 Lighting

The Lighting property page allows modification of the amount of light present in the Scene. Lighting values affect only objects drawn using surfaces.

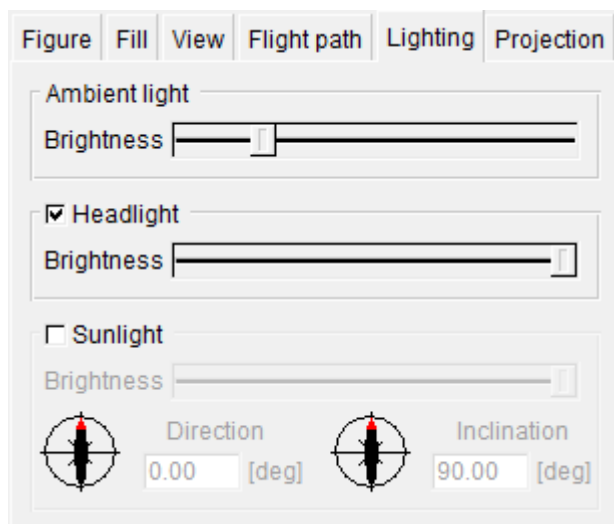

Figure 4.20 Lighting property dialog

- The Ambient light slider controls the amount of global non-directional light for the scene.
- The Headlight group controls a light source located at the Viewpoint directed at the Focalpoint.
- The Sunlight group controls an infinite distance directional light source:
 - The Sunlight Direction dial sets the compass azimuth of the light source with respect to the data-space, with the positive y-axis (North) representing 0.0 degrees. Combined with the Inclination dial, this gives the light source vector.
 - The Sunlight Inclination dial controls the astronomical azimuth of the light source, with the positive z-axis representing 90.0 degrees. Combined with the Direction dial, this gives the light source vector. A value below 0.0 degrees (the horizon) is allowed in order to illuminate the underside of surfaces.

4.14 Movie

The Movie property page controls the image size, length, and the file format for the recording of data frames from the Layout.

If the selected file format supports it, a frame rate can be entered, and a codec configuration dialog can be displayed using the Setup button.

The number of frames that will be recorded can be no more than the total frames available for the Layout. Playing begins from the currently displayed



frame, so you must remember to rewind to ensure a recording of the full animation.

Image	Movie	Print	Animation
Size 640 x 480 640x480			
Type Movie File			
Format AVI (Audio Video Interleave)			
Codec Full Frames (uncompressed)			
Quality 100			
Frame rate 15.000 15.000			
No. frames 97 [of 97]			
Setup...		Default	

Figure 4.21 Movie property dialog

NOTE: it is recommended to use a compressed Codec for large setups in order to limit the file size and increase the speed of file access.

See also Animation (p. 29).

4.15 Object

Every graphical object in a scene has an Object property page. This page allows you hide or show individual objects using the Visible checkbox, and to modify the name of the entry for the object in the Property Tree.

In case the object is a 3D solid property page will contain additional parameters.

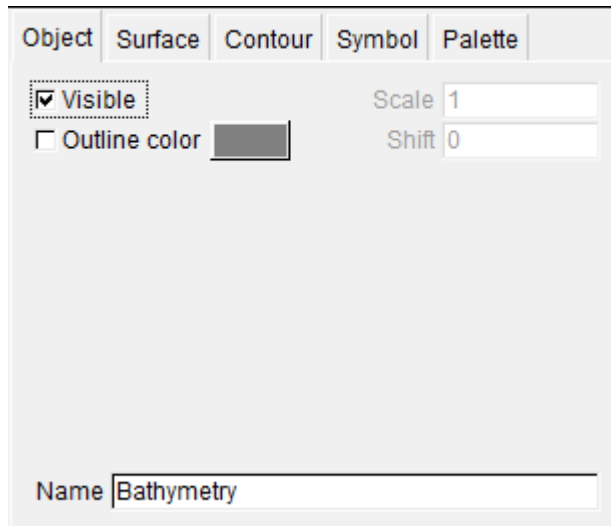

Figure 4.22 Default object property dialog

You may also use the context menu to adjust the settings.

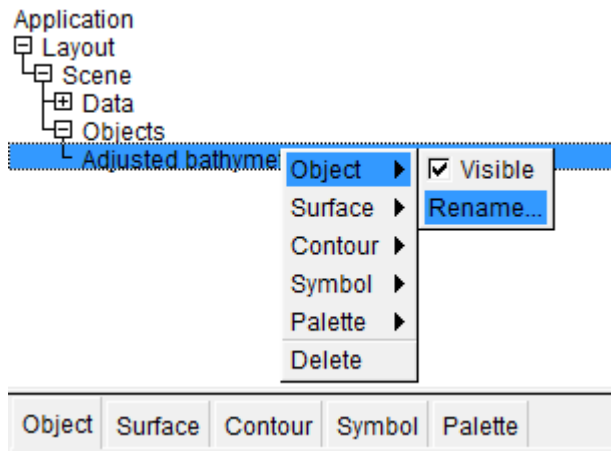

Figure 4.23 Context menu for graphical object

4.15.1 3D solid

In case the object is a 3D solid you furthermore have to define the properties for the Bounding box here.

Bounding box

A 3D solid has its own internal coordinate system. In order to scale the solid with the other objects in the scene you have to specify the extent of the bounding box in the three dimensions using the overall user unit for the



scene. The internal dimension from the 3DS file is shown as reference on the property page.

Per default the object is set to 'Uniform scaling' by which you only have to modify the extent in one dimension - the remaining dimension will be modified automatically.

Property	Value
Visible	<input checked="" type="checkbox"/>
Outline color	<input type="checkbox"/>
Scale	1
Shift	0
X extent	3.534 [m]
Y extent	15.046 [m]
Z extent	21.447 [m]
Uniform Scaling	<input checked="" type="checkbox"/>
Name	Solids Model

Figure 4.24 Example of object property dialog for a 3D Solid.

Note that using uniform scaling for a 3D Solid in a scene defined by LONG-LAT map projection will produce an inaccurate result.

Note also, that a vertical scaling of the entire scene in the View property page will not affect the size of the displayed 3D solid.

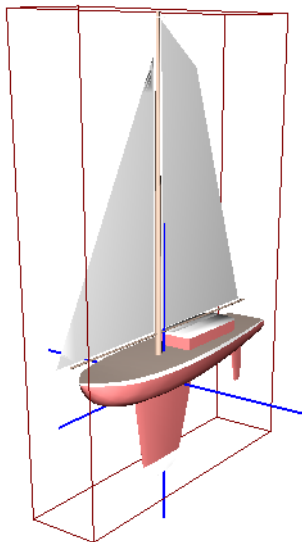

Figure 4.25 Example of bounding box for 3D solid

Note that it is possible to change the size dynamically (showing an instant update of the Graphics Window) by left-clicking the mouse in the input box and dragging the cursor left and right.

4.16 Objects

All objects within a scene are per default drawn in the order they have been defined. The drawing order becomes important when using transparency and anti-aliasing, since such objects need to be drawn last.

You can modify the drawing order from the Objects property dialog, which is active when selecting the Objects entry in the property tree. Use the drawing order toolbar in the lower right corner to move the objects up or down in the list.

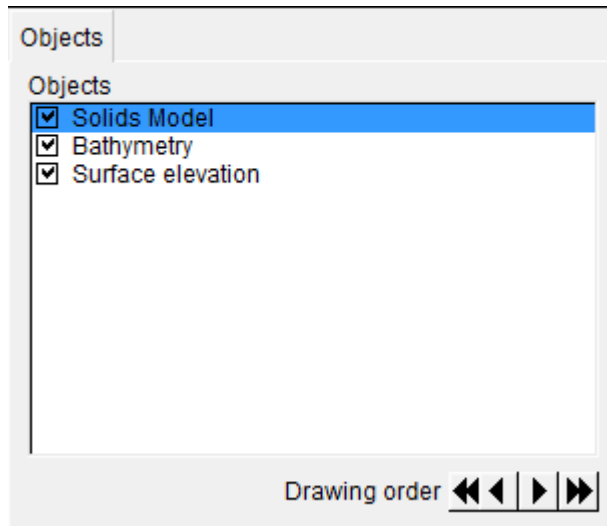

Figure 4.26 Property dialog for drawing order of objects

4.17 Palette

Object types which can have multiple colors or can be contoured based upon its variable, will have a Palette property page.

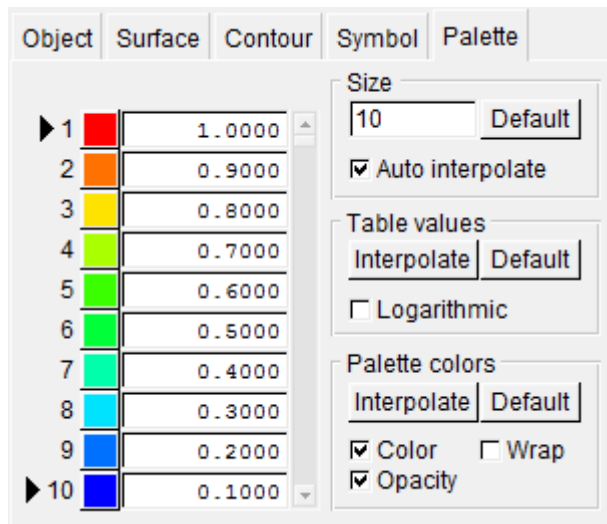

Figure 4.27 Object palette property dialog

The Palette page controls the spectrum and lookup table for all multi-colored styles and, for mesh-based objects, the number of contour levels as well.



The user can linearly or logarithmically interpolate the palette table values between the first and last values. Likewise, colors are linearly interpolated through HLS color-space.

Individual values can be edited by entering in the input fields. Clicking a color button, will display a Palette color selection dialog with the added feature of adjusting the opacity of the color.

Preset color palettes include Rainbow, Land, Water, Deposition, Banded and Topo-Bathy schemes. Dependent on the Item type the default Object type will utilize a certain preset color palette.

A context menu is available for loading and saving palettes to file, and for copying palettes from one object to another.

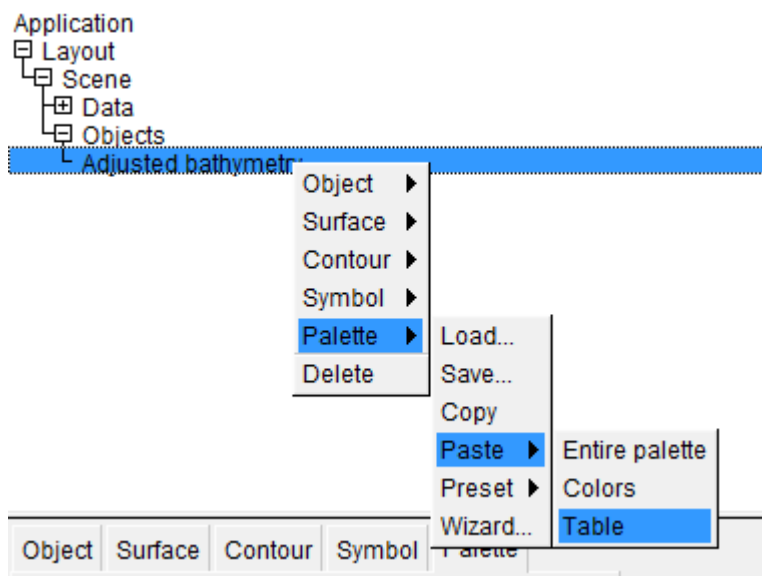

Figure 4.28 Object palette context menu

4.17.1 Palette color

The Palette color dialog enables you to control the color and opacity of a color entry in the Palette.

The dialog display both the HLS and RGB values of the chosen color.

The opacity of the color is determined by the Alpha value:

- For Alpha = 0 the color is fully transparent
- For Alpha = 255 the color is not transparent



When interpolating colors in the palette the opacity value will be interpolated as well.

NOTE: Objects using transparency should be put last in the drawing order of the scene.

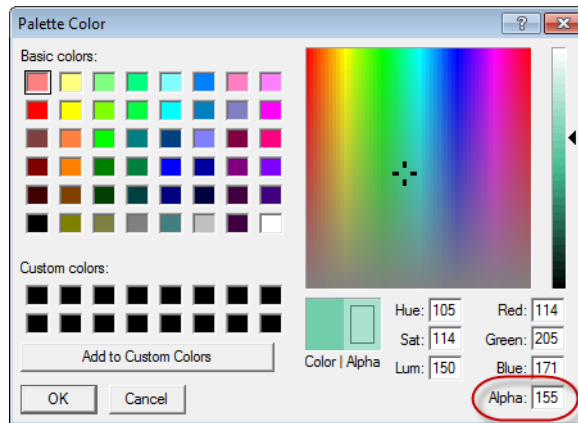

Figure 4.29 Color palette dialog

4.18 Preferences

Application preferences are program settings which are not saved with the Layout, but are applied every time the program starts. These settings are specific to each individual user.

The Preferences property page is available when Application is selected in the Property Tree.

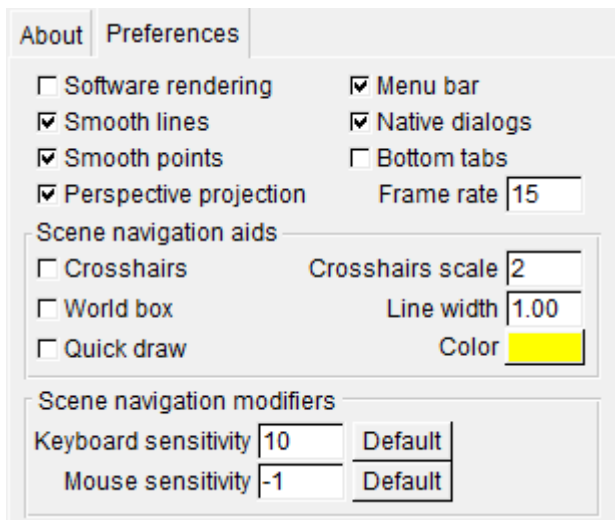

Figure 4.30 Application preferences dialog

- The Software rendering checkbox forces OpenGL rendering to bypass the hardware acceleration provided by some graphics cards. This is used to correct for problematic drivers. This will however usually slow down performance.
- The Smooth lines and Smooth points checkbox enables OpenGL anti-aliasing for certain styles using points and lines.
- The Perspective projection checkbox sets the user preference for the default view when creating Scene figures.
- The Menu bar checkbox toggles display of the Menu Bar. This is useful for maximizing the work area, as most of the Menu Bar functions are available through other methods.
- The Native dialogs checkbox sets the user preference for using certain dialogs provided by the native operating system, or alternative dialogs provided by the GUI toolkit (ftk). This could e.g. relate to the Palette.
- Bottom tabs position the tabs on the Property pages to the bottom of the dialog. Unchecked the tabs will appear at the top of the dialog.
- The Frame rate input allows slowing the interactive animation by inserting a pause between frames. The value is in frames per seconds and must be a positive value.

The Scene (VR) navigation aids include a crosshair and a world (data-space) bounding box which can be modified from this page. There is also a Quick Draw option which renders only the crosshair and World box when dragging the view in the Scene Window.



The Scene (VR) navigation modifiers are scaling factors for mouse and keyboard navigation in the Scene Window. Negative values reverse the sense of motion.

4.18.1 World box

All objects define a surrounding bounding box that reflects the spatial domain the object occupies. The world box is an outline of the combined spatial domain for all objects within the individual scene.

The world box will automatically adapt when new objects are included in the scene (except when the object is a 3D solid).

4.19 Print

The Print property page displays the current printer configuration, and allows the user to display a page setup dialog using the Setup button.

Scaling the output reduces the memory required to render the off-screen bitmap, which may be required for large print sizes.

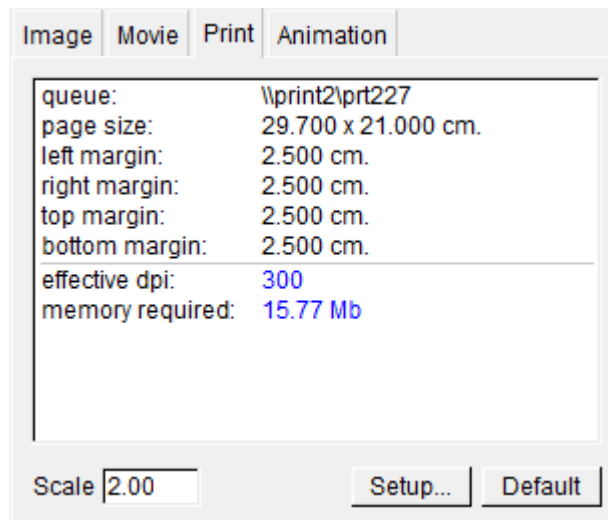

Figure 4.31 Print property dialog

4.20 Projection

The spatial data is referenced by a certain map projection. Per default the map projection is obtained from the first specified data file in the scene.

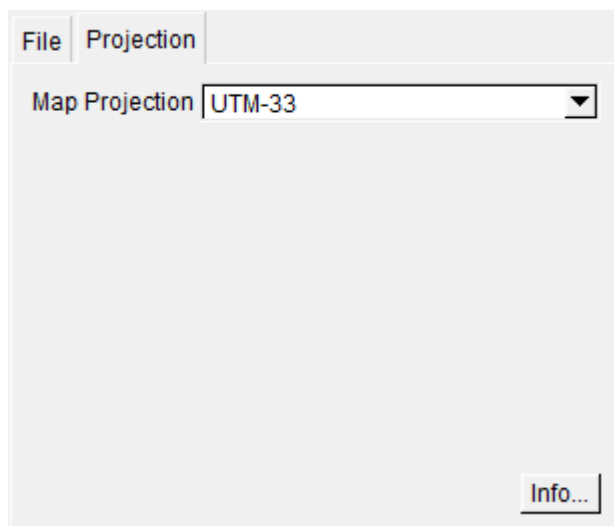

Figure 4.32 Projection property dialog

4.21 Slice

An object type such as Slice and Isosurface will have a Slice property page for defining how to extract the object from the volume.

Dependent on the type of slice, chosen by the context menu, the slice properties is defined by a Horizontal slice or a Vertical slice.

4.21.1 Horizontal slice

The slice level can be modified by defining the level directly or by using the scroll bar.

Note that the definition of the slice level depends on the type of slice:

- Layer slice
Level relates to the the layer number.
- Horizontal slice
Level relates to the vertical z-level
- Isosurface
Level relates to the value of the selected variable
- Isosurface with mapped variable
Level relates to the value of the selected variable and the color to the mapped variable

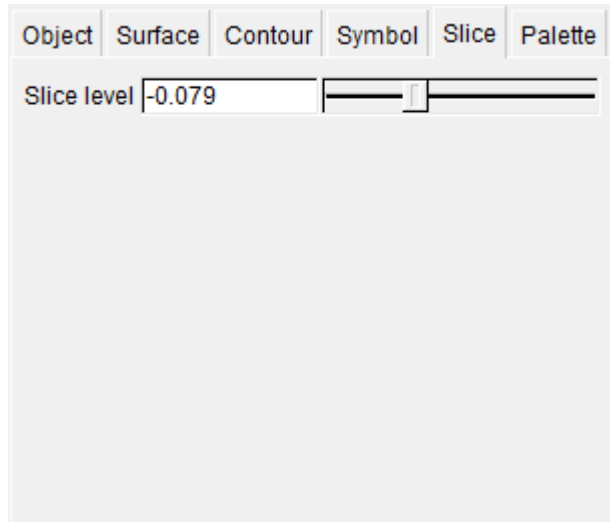

Figure 4.33 Slice property dialog for horizontal slice

4.21.2 Vertical slice

The location of the vertical slice is defined by the directions of each of the end points relative to the center point of the domain area. You can visualize the position of the vertical slice by checking the Slice points visible.

The position of the slice line can be modified by defining the direction of the end points directly or by using the scroll bar.

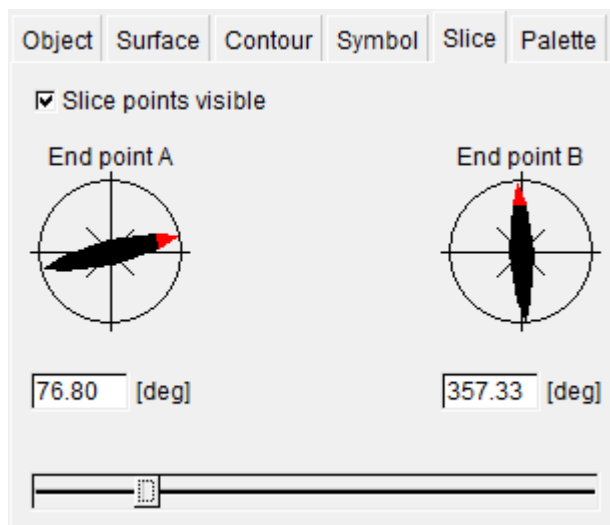

Figure 4.34 Slice property dialog for vertical slice



4.22 Solids

The initial translation and rotation of a 3D solid within the scene are specified in the Solids property dialog.

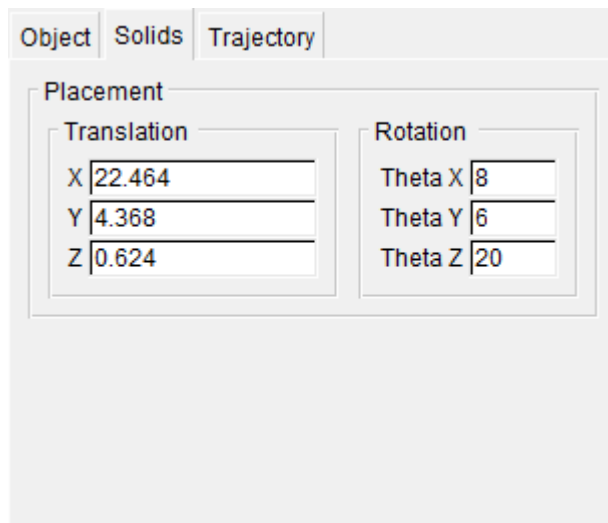

Figure 4.35 Solids property dialog

The Translation coordinates specifies the position of the origo of the solid.

The Rotation angles specifies the rotation of the solid around the three axis. For typical applications such as visualising a sailing ship the solid remains horisontal and only rotates around the Z axis.

Note that it is possible to change the parameters dynamically (showing an instant update of the Graphics Window) by left-clicking the mouse in the input box and dragging the cursor left and right.

In case the solid is to move in time, the translation and eventual rotation must be defined by the Trajectory (p. 63).

4.22.1 Definition of solids

A 3D solid has it's own internal coordinate system and is defined by a bounding box and an origin.

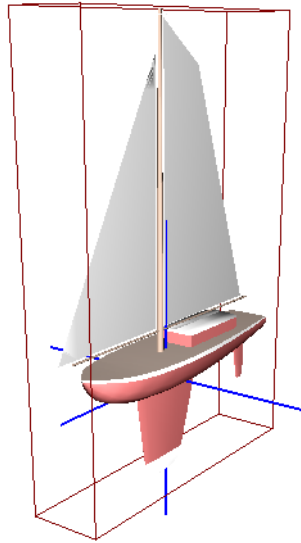

Figure 4.36 Illustration of bounding box and origin of 3D solid

Note that the origin of a solid does not have to be at the exact center or at a corner of the bounding box. E.g. for the solid shown in Figure 4.36 the origin is placed in the lower half of the bounding box.

In order to place the solid correctly within a scene you have to

1. Scale the solid (See Bounding box (p. 48))
2. Translate the solid by a vector
3. Rotate the solid around the three axis

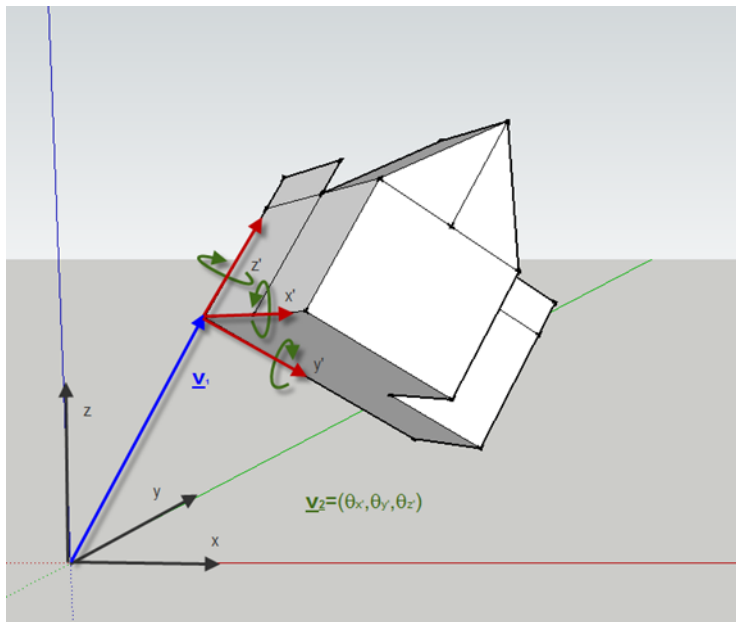

Figure 4.37 Illustration of translation and rotation of solid

4.23 Surface

Object types which can be displayed as a surface will have a Surface property page.

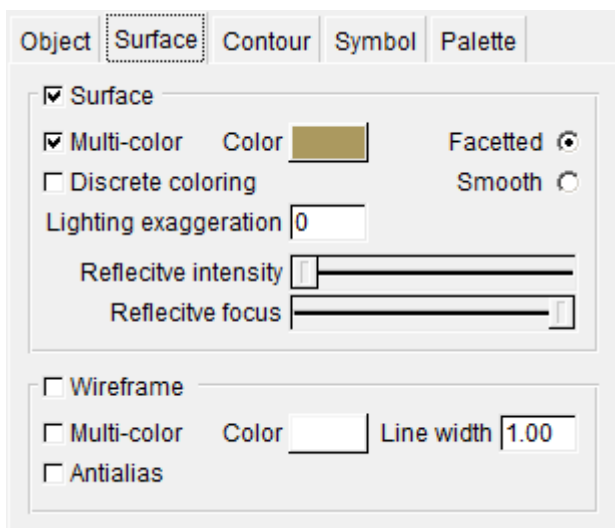

Figure 4.38 Surface property dialog



The Surface property page controls the type of coloring used for the surface and whether to display the values as Facetted or Smooth.

Effect of Lighting and Reflection can be controlled via the Lighting exaggeration value and the Reflective parameters specified via the scroll bar.

Note: It is possible to drape a georectified image over the surface area (see Image (Draped) (p. 41)).

Note: A special kind of surface object is the static Bathymetry values from dfs files.

4.24 Symbol

Object types which has values that can be can be displayed as symbols will have a Symbol property page.

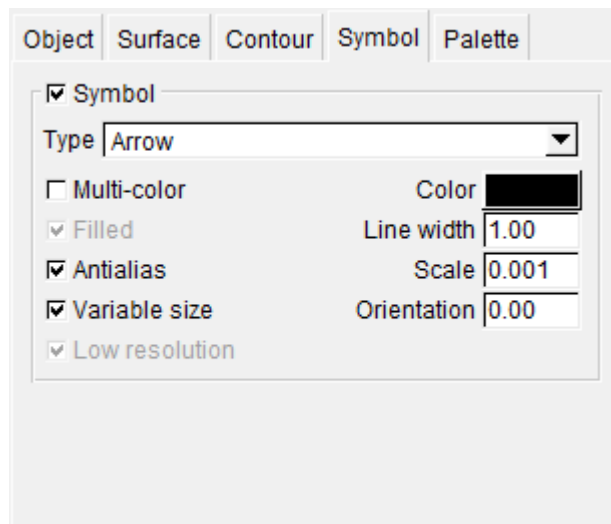

Figure 4.39 Symbol property dialog

The Symbol property page controls the display of symbols. The list of available symbols depends on the type of variable to be displayed.

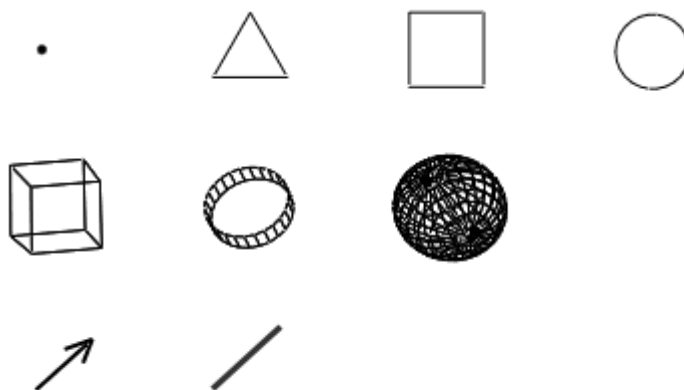

Figure 4.40 Available symbols

In case Multi-color is un-checked the color of the symbols is defined by the Color in the menu, otherwise the symbol colors are defined by the Palette color for the given data value.

In case Variable size is checked the symbol size will be scaled by the given data value, otherwise the symbol size will be the same for all values. Note that the Scale value in the two cases cannot be related.

4.25 Text

Text figures are 2D labels.

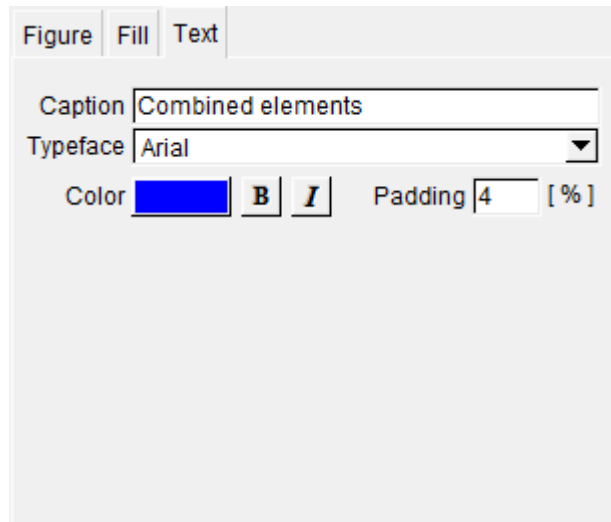

Figure 4.41 Text property dialog

- The Caption property is the text to be displayed.
- The font is determined by the Typeface, Color, Bold, and Italic controls.
- Padding is the relative amount of space added between the bounds of the caption and the entire figure

4.26 Trajectory

This property page is used for specifying the dynamic movements of a 3D solid.

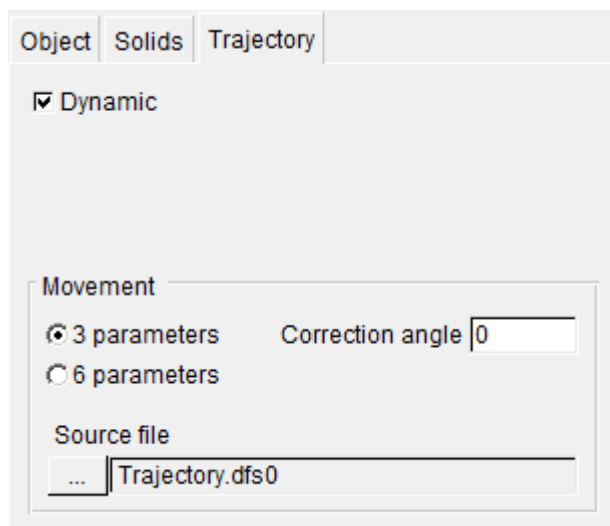

Figure 4.42 Trajectory property page

In case the solid is to move dynamically in the domain, you first have to click the Dynamic check-box to enable the input of the dynamic movement parameter.

The movement is specified in a Source file using one of two formats:

- 3 parameters
(x,y)-position and zlevel-position as items in a dfs0 file
- 6-parameters
x, y, zlevel, theta(x), theta(y) and theta(z) as items in a dfs0 file

When using a 3-parameter file the solid is assumed to remain horizontal in the scene and automatically rotate around the vertical z-axis by following the direction of the trajectory (e.g. a solid representing a ship will always face forwards even as it changes course).

The Correction angle specifies a constant correction value to be added to the automatic rotation around the vertical axis.

When using a 6-parameter file the movements of the solid can be freely defined.

See also Solids (p. 58) and Bounding box (p. 48).



4.26.1 Source file

The trajectory parameters in the time series file must be given in the correct order and use the specific item types as defined in Table 4.1.

Table 4.1 Item description in trajectory file

Item number	Description	Item type
1	X-coordinate	Geographical coordinate
2	Y-coordinate	Geographical coordinate
3	Z-coordinate	Item geometry 3-dimensional
4	Rotation around X-axis	Angles
5	Rotation around Y-axis	Angles
6	Rotation around Z-axis	Angles

4.27 View

The View property dialog can be used for specifying how to view the data space. There are a number of other ways to modify the parameters and the values in the dialog will automatically be updated accordingly.

The screenshot shows the 'View' property dialog with the following settings:

- Focalpoint:** X: 306818.0966, Y: 965892.3838, Z: -412.243
- Frustum:** Field of view: 45.000, Near clipping: 202.288, Far clipping: 111258.249
- Viewpoint:** X: 306818.0966, Y: 981063.9631, Z: 9702.143
- Projection:** Perspective (selected), Orthogonal
- Vertical scaling:** 9.5
- Viewing distance:** 18233.969

Buttons: Default, Undo, Apply, Auto apply

Figure 4.43 View property page

4.27.1 Definition of Parameters

The scene is normally viewed in perspective, which is achieved by drawing within a pyramidal frustum. Figure 4.44 illustrates this from a 2D side view.

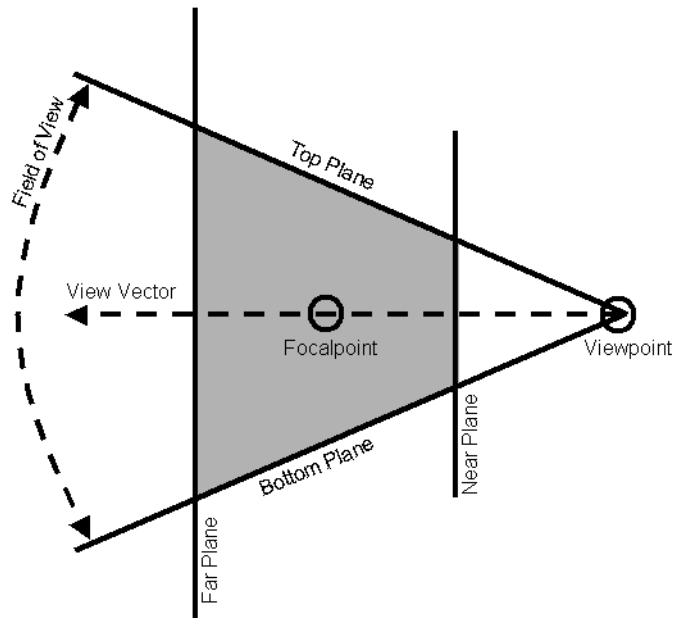

Figure 4.44 Definition of view parameters within pyramidal frustum

The frustum is bounded by six clipping planes: Near and Far, Top and Bottom and Left and Right. In Figure 4.44, the Left plane of the frustum is represented by the shaded region.

Viewpoint

The Viewpoint is specified as the location from which you are looking.

Focalpoint

The Focalpoint is specified as the location at which you are looking.

Near and Far

The Near and Far planes are specified by their distance from the Viewpoint. Near and Far are internally calculated based upon the size of the data-space, and rarely need to be adjusted.

NOTE: small solids may disappear in large domains.



Top and Bottom

The Top and Bottom planes are specified by a Field of view angle, which also rarely requires modification. Changing the Field of view produces a zoom effect, but at its extremes will distort the image.

Left and Right

The Left and Right planes are internally calculated to achieve the aspect ratio of the Scene Window.

View Vector

A derived parameter, the View Vector (line of sight), is the direction from the Viewpoint to the Focalpoint. Moving the View Vector is analogous to moving through the landscape while always looking in the same direction.

View Distance

The length of the View Vector between the Viewpoint and Focalpoint is referred to as the View Distance. Modifying the distance will move the Viewpoint along the View Vector. This is the preferred method for achieving a zoom effect.

Up Vector

The final view-defining parameter is the Up Vector, which is fixed to the positive z-axis. The limitations due to this are that the observer must always have a level attitude, which prevents roll and pitch. References to directions in the data space assume that the positive x-axis points east, the positive y-axis points north, and the positive z-axis points up.

4.27.2 Modifying view parameters

Editing by View dragging

The most common method for changing the view is by using the mouse within the Scene Window. This feature, referred to as View Dragging, allows you to move the current View Component horizontally by clicking with the left mouse button and dragging the mouse cursor. To move the selected component in the vertical, hold down the <Ctrl> key while dragging. Alternatively, the keyboard arrows can be used to duplicate dragging the mouse.

The current View Component is selected from the following buttons on the Tool Bar:



Viewpoint



Focalpoint



View Vector



Editing by context menu

The View Component can also be selected from among the first three menu items of the context menu in the Scene Window.

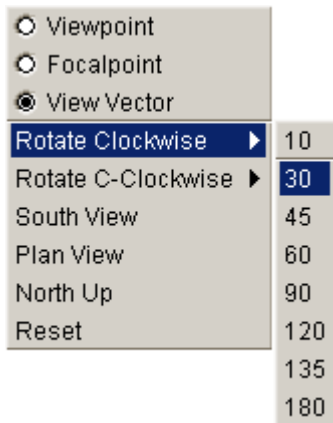

Figure 4.45 Context menu for Scene Window

The Rotate Clockwise and Rotate C-Clockwise functions each present a sub-menu of common angles. Making a selection will rotate the Viewpoint around the Focalpoint in the horizontal relative to its current position.

The South View function centers the Focalpoint in the data-space and moves the Viewpoint far to the south and above the horizon, so you can see the entire data-space.

The Plan View function centers the Focalpoint in the data-space and moves the Viewpoint far above and slightly to the south, so you can see the entire data space from overhead with north at the top of your screen.

The North Up function rotates the Viewpoint around the Focalpoint in the horizontal to give a view from the south without modifying any other parameters.

The Reset function recalculates the size of the data-space and the frustum then sets a South View. This may need to be done whenever an object with substantially different coordinates is displayed. This can also be done using the Default button on the View property page. For an orthogonal projection, these set a Plan View.

Editing View Distance by rollers



Two rollers on the Tool Bar can be used to adjust the View Distance. The top roller is for coarse changes and the lower one is for fine adjustment.

The scroll wheel on the mouse may also be used for coarse changes to the View Distance when working in the Scene Window.



Editing by View property page

The configurable view parameters can be manually edited from the View property page for the given Scene.

The perspective view can be toggled to orthographic via the Projection radio buttons. This is used primarily for overhead views to avoid the distortion due to perspective. It can be disorienting otherwise.

4.27.3 Saving/Loading view parameters

The current view parameters can be imported and exported to external files using the Load and Save selections from the context menu. They may also be transferred from one Scene to another using the Copy and Paste selections from the context menu.

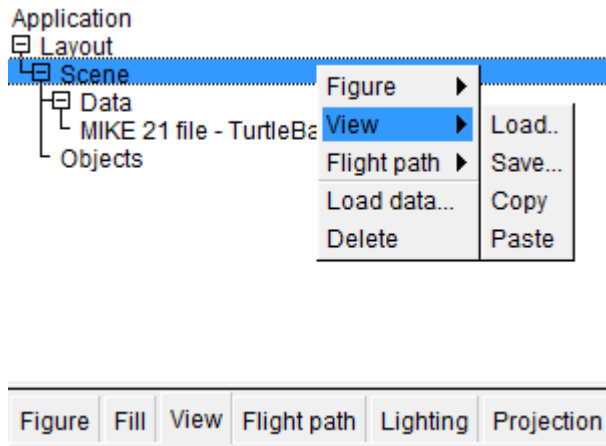

Figure 4.46 Edition of View parameters from context menu

4.27.4 View history

A history of views for each Scene is retained and updated each time the view is changed. The view history is controlled from the keyboard and navigated as follows:

<Home>	→	first stored view
<End>	→	last stored view
<Page Up>	→	previous stored view
<Page Down>	→	next stored view





5 Examples

5.1 General

One of the best ways of learning how to use MIKE Animator Plus is through practice. Therefore examples are included which you can go through yourself and which you can modify, if you like, in order to see what happens if one or more parameter are changed.

The examples are located in the default installation folder, e.g. c:\Program Files (x86)\DHI\2017\MIKE Animator Plus\Examples. Please note that the files should be copied manually to another folder on the harddisk, e.g. under 'My Documents', before attempting to work with the examples as working with files located under c:\Program Files (x86) is not recommended.

The example **Visualisation of Model Area** (p. 72) describes a simple MIKE Animator Plus application in order to get you started. The “what key to press” procedure for going through this example is given in great detail (what to select in the different dialogs) as well as additional information about the various properties to set in MIKE Animator Plus.

The example **Creation of Animation** (p. 80) describes another simple MIKE Animator Plus application on how to set up a model and create a flight path, which is followed in the video generation. The “what key to press” procedure for going through this example is given in great detail (what to select in the different dialogs).

The example **Combining Elements in Layout** (p. 87) describes how to display several graphical elements simultaneously in MIKE Animator Plus.

The example **Image Draping** (p. 94) describes how to drape a geographical referenced image over a bathymetry in the MIKE Animator Plus application.

The example **Basic Solids** (p. 99) describes the solids available from the installation and how to add and position a solid in a scene.

The example **Using Solids** (p. 104) describes how to add and move solids in a scene to enhance the understanding of the model setup.

The example **Displaying particles** (p. 114) describes how to add and use particles from a DHI XML particle track file in a scene, e.g. for illustrating an oil spill by the change and movement of individual oil particles.

More advanced examples involving MIKE Animator Plus visualisation of waves and wave breaking near land and coastal structures can be found in the MIKE 21 BW User Guide.



In addition the Quick-Guide (*p. 121*) explains how to create a number of common types of display using screen dumps to illustrate the steps.

5.2 Visualisation of Model Area

This example gives a short introduction to how the visualisation of a model area takes place in MIKE Animator Plus. You do not need to know this to be able to use MIKE Animator Plus as the menu-driven interface and toolbar facilities including interactive navigation by mouse control is fully sufficient to prepare camera path and views. However, it serves as general background information and is also relevant if you need to relate a specific location in your model to the camera path or to a focal point in MIKE Animator Plus.

The purposes with this example are twofold:

1. Demonstrate the capabilities of MIKE Animator Plus and how to use it.
2. Explain what MIKE Animator Plus does and some of the features related to 3D graphics.

Furthermore, through this example you will:

- learn to start MIKE Animator Plus
- learn to load and display a bathymetry file and
- learn how MIKE Animator Plus views are made

5.2.1 Description of data

The model area used in MIKE 21/3 applications is typically represented by a bathymetry file (*.dfs2 files for rectangular grid, *.mesh or *.dfsu for flexible mesh).



Note: Due to differences in handling rectangular grid files (dfs2) and flexible mesh files (mesh/dfsu) in the geographical environment it is not possible to mix the two types of files in the same view.

The model bathymetry to be used in this example, Turtle Bay, is shown in Figure 5.1.

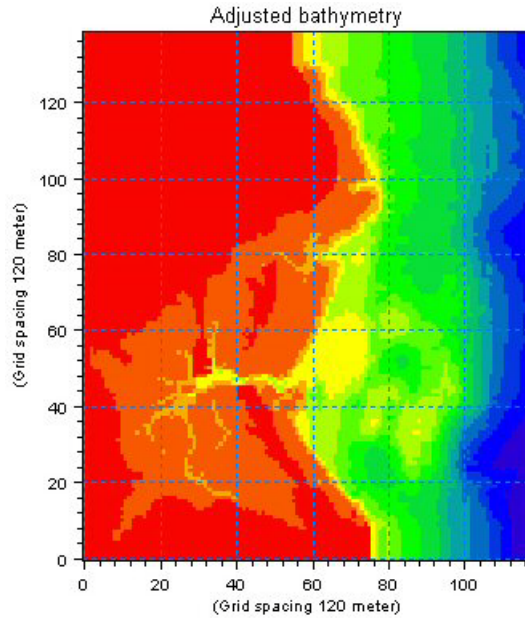

Figure 5.1 Example of model grid

The bathymetry file holds information about the depth (z) in the model grid points (j,k). Depth values for grid points below the chosen datum are negative.

The bathymetry file also contains information about the model orientation compared to true north. When setting up a MIKE 21/3 model using rectangular grid it is often necessary to rotate the model grid to obtain the best representation of flow phenomena within the model area and at the boundaries.

5.2.2 How to start MIKE Animator Plus

The MIKE Animator Plus User Interface (GUI) can either be started from the start menu or by clicking 'Animator.exe' in the basic directory of the installation. Alternatively, you can place a shortcut on your desktop for faster access.

This will open the MIKE Animator Plus interface with an empty Graphics Window as shown in Figure 5.2.

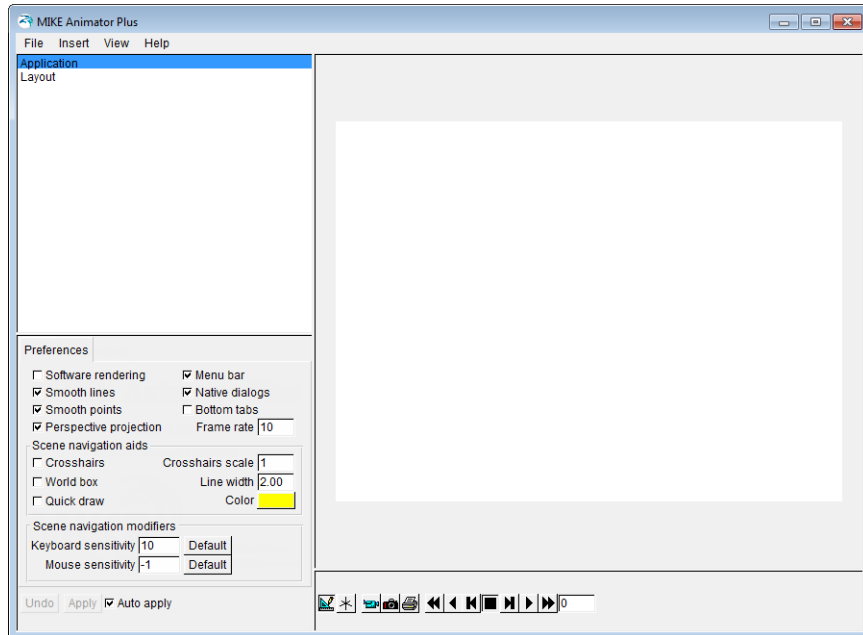
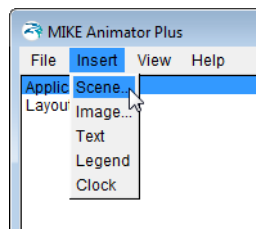

Figure 5.2 The initial MIKE Animator Plus user interface

5.2.3 Load data file

You load your MIKE 21 bathymetry data file into MIKE Animator Plus as follows:

- From the Menu Bar select Insert → Scene...



- Select *TurtleBayBathy.dfs2* from the MIKE Animator Plus example directory *.MIKE Animator Plus\Examples\TurtleBay*.

The MIKE 21 file will now be added to the Property Tree and a (still empty) outline of the domain encompassing the model area (World box) is shown in the Graphics Window, see Figure 5.3.

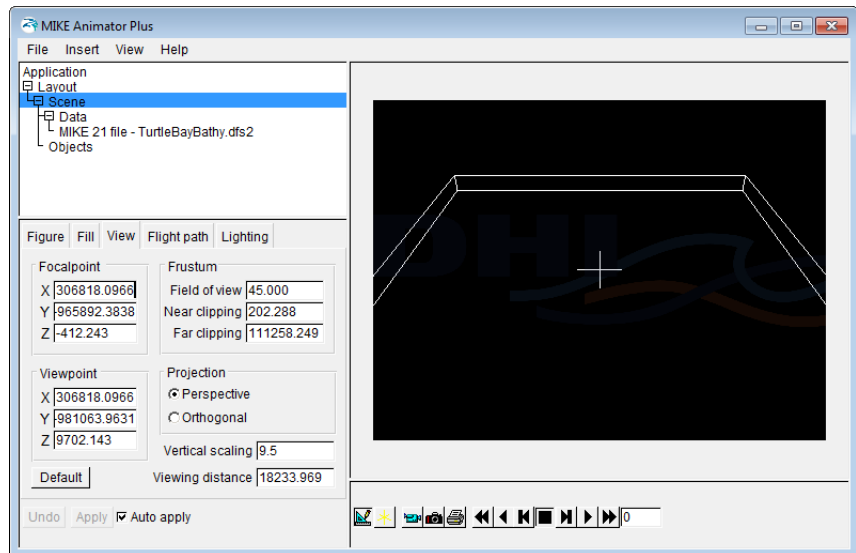
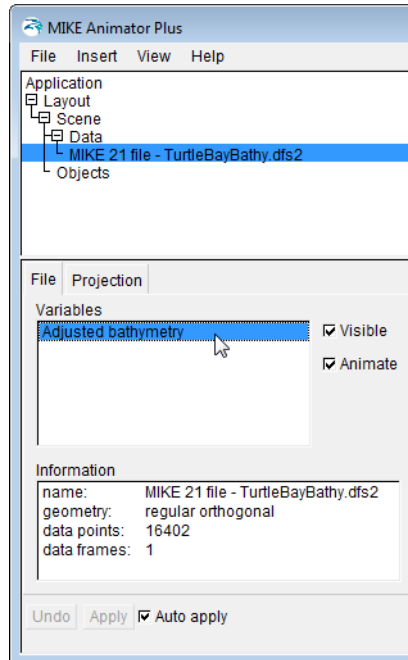

Figure 5.3 User interface after Bathymetry data file has been selected

5.2.4 Select item to display

You must now select which item to include in the layout.

- Select the file name in the Property Tree and double-click the variable *Adjusted bathymetry* in the Property Pages.



This will show the bathymetry in the Graphics Window and activate the Property Pages valid for the selected object, see Figure 5.4.

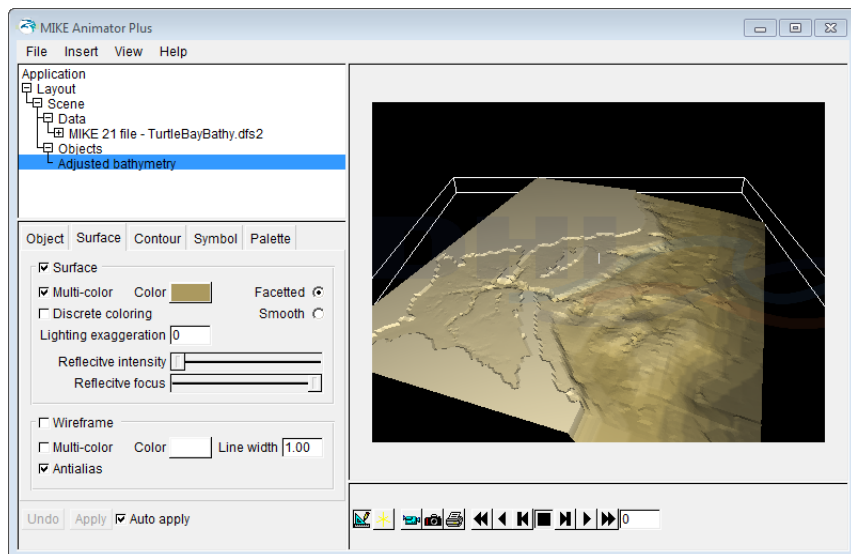

Figure 5.4 Default view of model bathymetry in MIKE Animator



5.2.5 Views of model areas in MIKE Animator

Coordinate system

The viewing space in MIKE Animator Plus is a Cartesian coordinate system with the x-axis spanning from left to right, the y-axis from bottom to top and the z-axis from far to near, i.e. perpendicular to the screen towards the eyes. The orientation of the y-axis is true north.

When a bathymetry file is loaded into MIKE Animator Plus, the coordinates relates to the origin of the given map projection for the scene.

Vertical scaling

The width and length of a model is usually several times larger than the deepest water depth within the model area. This implies that in order to enable display of visible differences in topographical or bathymetric conditions it is necessary to use another scaling in the vertical plane than applied in the horizontal plane. No distortion of the vertical scale (z-axis) as such is made in MIKE Animator Plus but the depth values in the bathymetry file are multiplied by a factor when shown on the screen. The value of this scaling factor depends on the ratio between the actual range of depths and the width and length of the area. Normally a factor of approximately 10 is used as default.

You can check the value applied and the effect of changing it by modifying the value in the View property page for the given scene, see Figure 5.5.

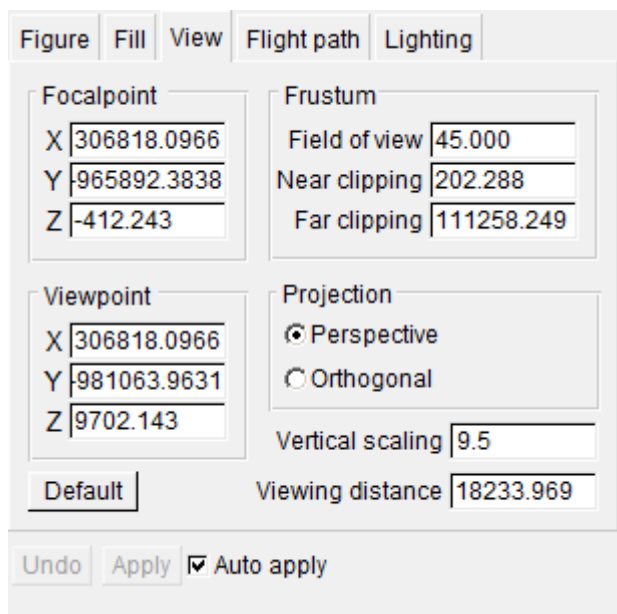

Figure 5.5 View property window for loaded bathymetry data. The Vertical scaling factor value is found as 9.5.

Perspective view

The perspective view is by default a south view at an inclination about 30 degrees with the focal point centred approximately in the middle of the model area. You can check and modify these settings in the View Property dialog (see Figure 5.5). However, before you do so you should reset the view either in the View Property dialog or by right clicking the mouse in the Graphics Window and select Reset from the pop-up menu that appears.

In the View property menu you define how you want the scene to be viewed, the view point and focal point and the parameters defining the view field (frustum).

Navigation style

The navigation style can be selected from the Toolbar below the Graphics Window when display is in Scene mode. The navigation styles determine whether you want to move the view point or the focal point when moving the cursor, or use a view vector for the navigation. The effect displayed on the screen that follows from keypad arrow operations (or by moving the mouse in the same directions) are illustrated in Figure 5.6, Figure 5.7 and Figure 5.8 for the different styles.

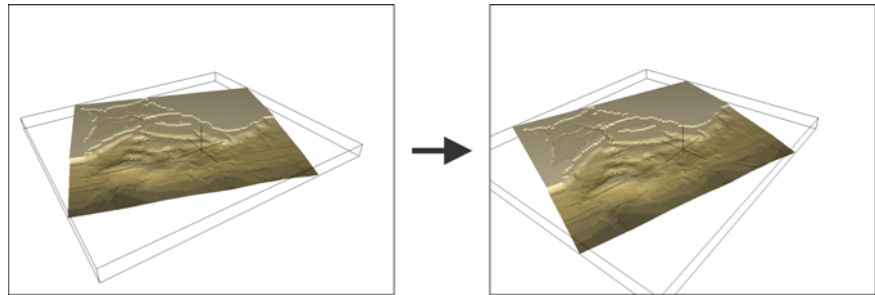

Figure 5.6 Navigation style, View point mode
 Horizontal key/mouse operations result in rotation of the view point around the focal point at a fix distance; vertical operations zoom in or out with the focal point fixed, and with the Ctrl key pressed down you can change the height of the view point, i.e. the z-coordinate

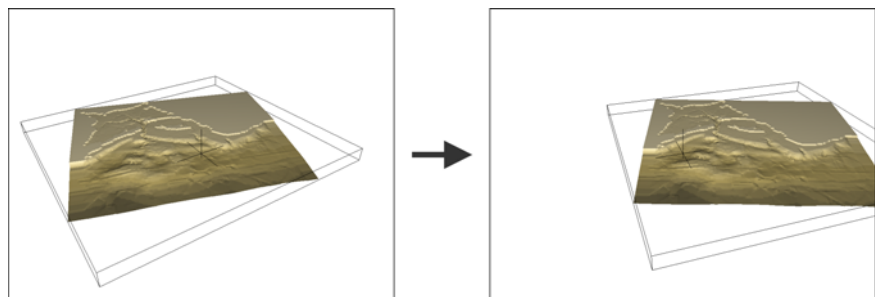

Figure 5.7 Navigation style, Focal point mode
 Horizontal key/mouse operations result in a rotation of the scene around the view point with the focal point fixed; vertical operations move the scene up or down, and with the Ctrl key pressed down these movements appear faster (larger increment)

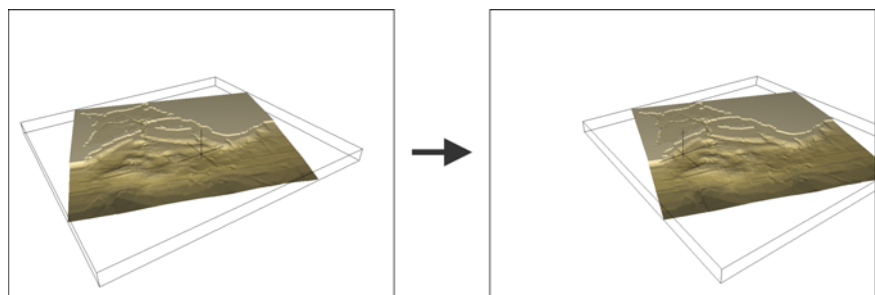

Figure 5.8 Navigation style, View vector mode
 Horizontal key/mouse operations result in pure horizontal transformation of the scene; vertical operations move the scene closer or further away.

5.2.6 Transformation of coordinates

The relation between model coordinates and the coordinates in the Graphics Window of MIKE Animator Plus can be found by the description above of the view of a model bathymetry.

5.3 Creation of Animation

The following example provides you with an introduction on how to quickly generate a movie.

5.3.1 Open MIKE Animator Plus

Select 'MIKE Animator Plus' from the Start menu. This will open the MIKE Animator Plus interface with an empty Graphics Window.

5.3.2 Load data

Now load your MIKE 21 result data file into MIKE Animator Plus as follows:

- From the Menu Bar select Insert → Scene...

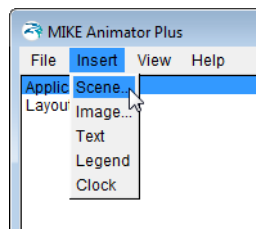

- Select *MIKE_Animator_Example.dfs2* from the MIKE Animator Plus example directory *.\MIKE Animator Plus\Examples\Animation*.

The MIKE 21 file will now be added to the Property Tree and a (still empty) outline of the domain encompassing the model area is shown in the Graphics Window.

Select the items bathymetry, surface elevation and current velocity to include in the layout.

- Select the file name in the Property Tree and in the File property page double-click the variables *Bathymetry*, *Surface elevation* and *Current Velocity* (in that order).

The MIKE 21 result data will load and be displayed in the Graphics Window, see Figure 5.9.

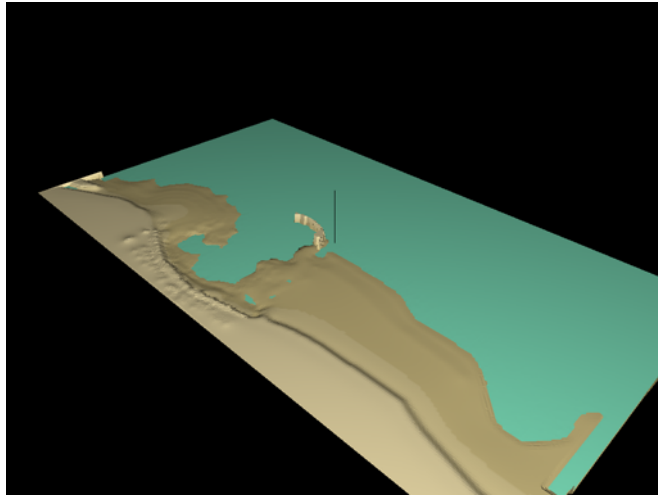

Figure 5.9 Graphics Window showing imported dfs2 file (without velocity arrows)

5.3.3 Adjust view properties

We will be creating an animation that first flies around the data space, then runs the model results. We must first orient the view to the desired starting point.

1. First ensure that the Graphics Window is displayed in Scene mode
2. Right click the mouse in the Graphics Window and select *Rotate Clockwise* -> 45 to obtain a view looking out towards the water from the shore.
3. Right click the mouse and select *View Vector*
4. Drag the cursor downward to come in closer to the focal point. The bathymetry should align with the bottom window edge

Once the view has been properly rotated, modify the Viewing properties

5. Click Application in the Property Tree and select the Preferences property dialog, see Figure 5.10.

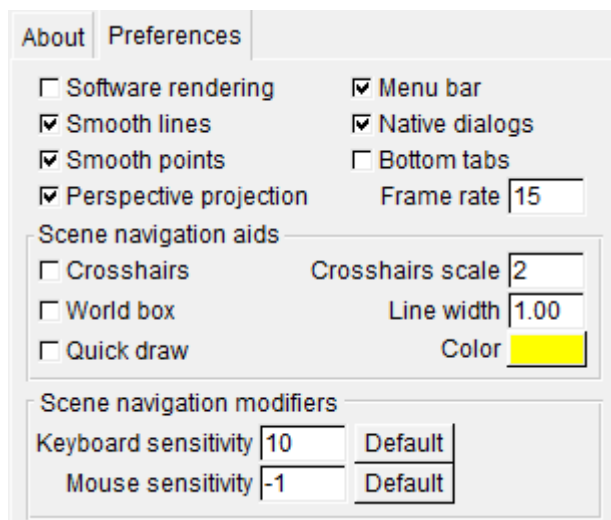

Figure 5.10 Application Preferences dialog

6. Uncheck the *Crosshairs*
7. Uncheck the *World box*

The preceding adjustments help to improve the aesthetic quality of the movie. Hiding the crosshairs is a common practice when recording a movie. Crosshairs, along with any other visual editing aids, such as e.g. a flight path, should not be visible during recording.

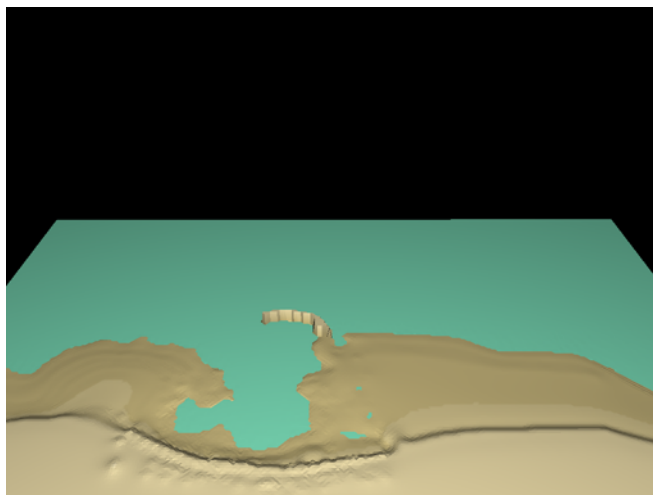

Figure 5.11 Graphics window after adjusting the View Properties



5.3.4 Adjust scene properties

With the view set, apply the following adjustments to the Scene

1. Click *Scene* in the Property Tree and select the Fill property dialog, see Figure 5.12. Check *Solid fill* and set the *Color* to black.

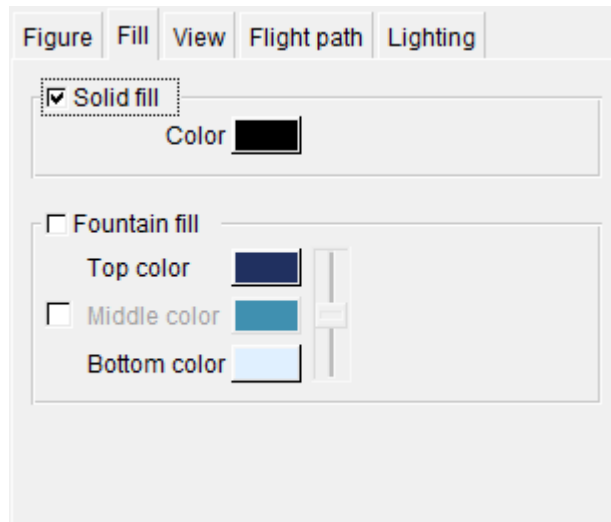

Figure 5.12 Fill property dialog for Scene

2. Click *Current Velocity* in the Property Tree and select the Symbol property dialog. Uncheck *Multi-color* and set the *Color* to black. Set the *Scale* to 1.0.

The resulting display will be similar to Figure 5.13.

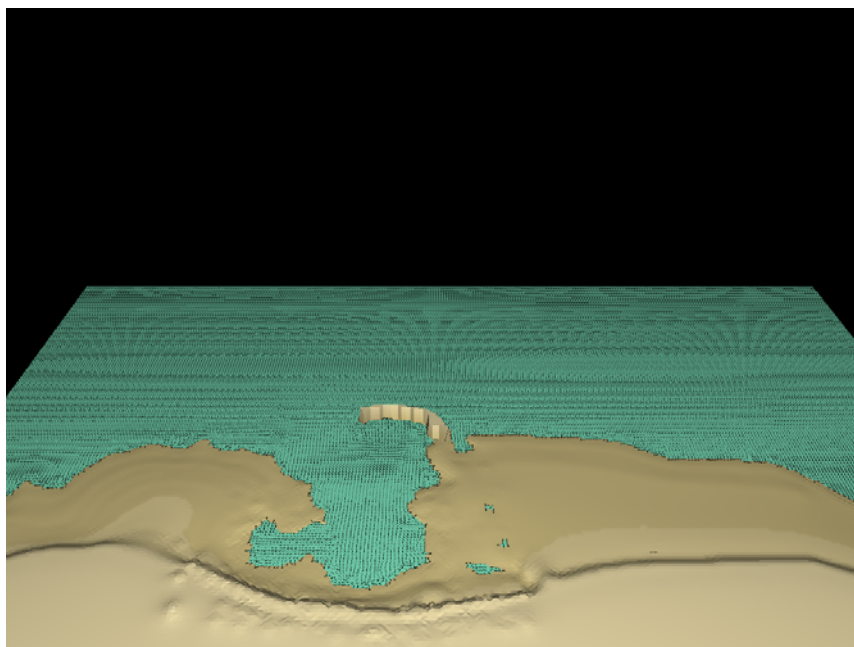



Figure 5.13 Graphics window after adjusting the Scene properties

5.3.5 Create a flight path

MIKE Animator Plus facilitates quick creation and editing of flight paths through its special context keys. To generate a flight path:



1. Click the *Edit Flight path* Button  from the Toolbar to create a default 180° flight path. The flight path will be displayed by path lines in the Graphics Window as shown below.

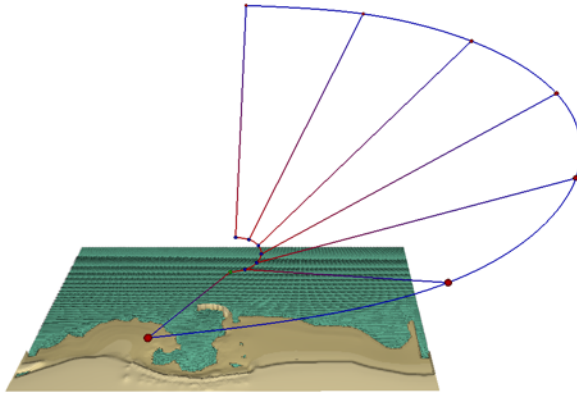

2. In the Flight path page change the *Path length* to 100 and check the *Animate* box
3. Un-check *Edit* to exit the edit mode
4. Un-check *Visible* to hide the path lines

You have now defined the position of the flight path. Next is to define the temporal extension of the animation.

5. Click *Layout* in the Property Tree and select the Animation property page.

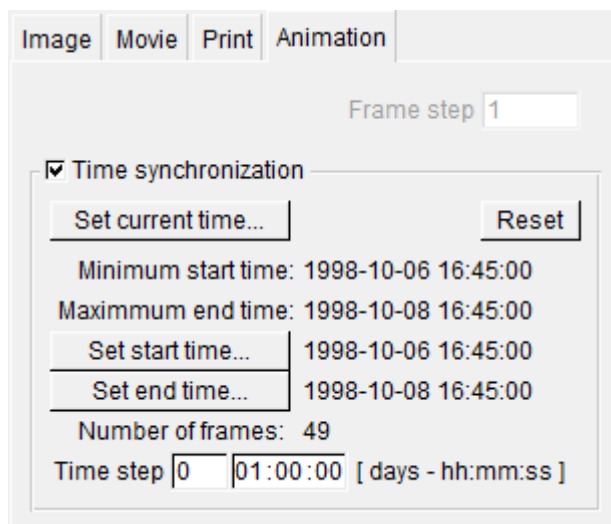

Figure 5.14 Animation property dialog for Scene

6. Check *Time synchronisation* to enable editing of the time settings.
7. Set the *Time step* to 1 hour

With the animaton properties now properly adjusted, you can view the anima-tion in the Graphics Window by clicking the Play button in the Toolbar and the movie may now be recorded.

5.3.6 Record a movie

Recording a movie with MIKE Animator Plus can be done with these simple steps:



1. Click *Layout* in the Property Tree and select the Movie property page.

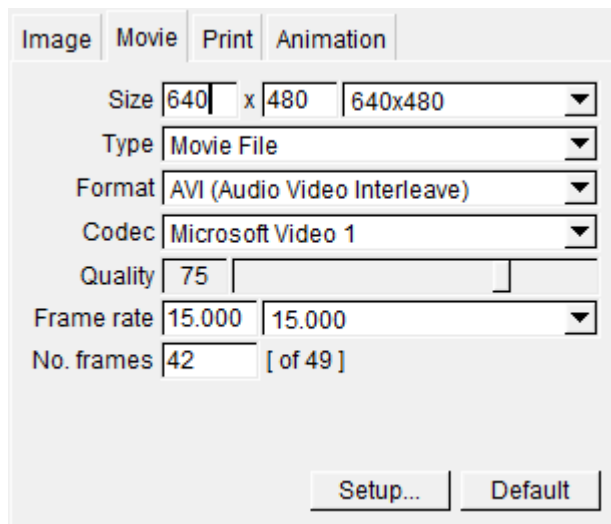



Figure 5.15 Movie property dialog for Layout

2. Define *Size* to 640x480 pixels and *Type* as Movie file.
3. Set the *Movie format* to AVI and the *Codec* to *Full Frames (Uncompressed)* (this will ensure the best quality of the movie)
4. Set the *Frame rate* to 15 and the No. frames to 49
5. Click *rewind* on the Toolbar to ensure the animation is at its starting point



6. From the Menu bar select File->Record... or press the *Record animation of layout* button  on the Tool bar.

Now you have to define the appropriate directory and file name for the movie. Once you have a pressed OK for the file name the movie will begin to be generated.

5.4 Combining Elements in Layout

The following example provides you with an introduction on how to display 2 scenes in the same animation together with a text, a color legend and a clock.

By selecting the individual scenes you can adjust the scene properties, e.g. should it be a 'frozen' view or a flight path, which palette should be used etc.

The functionalities described in Sections 5.3.3 and 5.3.4 for adjusting the *View-* and *Scene properties* are applicable for the individual scenes in the window.

5.4.1 Open MIKE Animator Plus

Select 'MIKE Animator Plus' from the Start menu. This will open the MIKE Animator Plus interface with an empty Graphics Window.

Before continuing, ensure that you have view the Graphics Window in Layout mode.

5.4.2 Load data

First load and position your MIKE 21 result data into the Graphics View:

Scene0

1. Select Insert in the Menu Bar and insert a scene using *MIKE_Animator_Example.dfs2* from the previous example
2. Select the items bathymetry and surface elevation to include in the layout
3. Click the Scene in the Graphics window and drag the upper right corner down left to decrease the size of the scene.

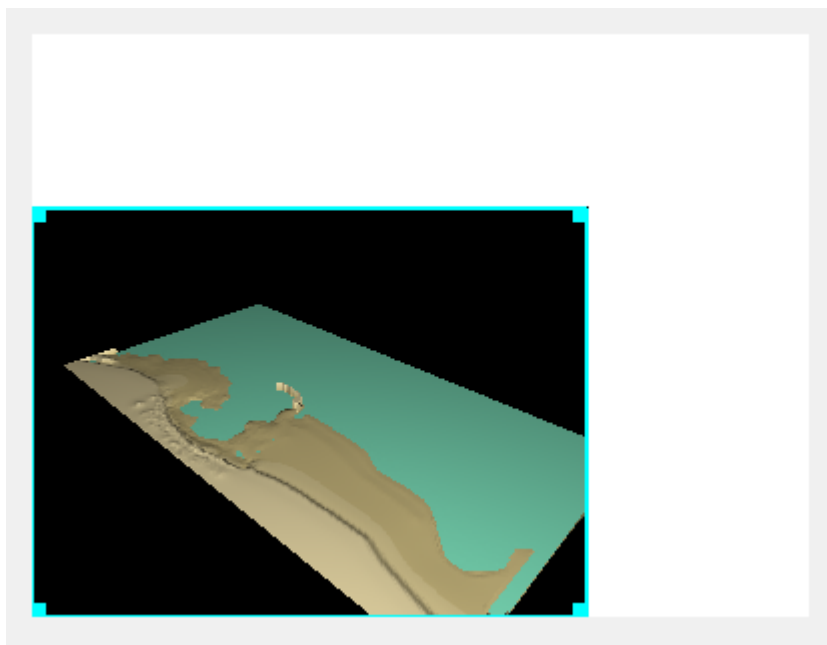

Figure 5.16 Reduced view area for Scene0 in Graphics View



4. Define the layout of Scene0 as described in section 5.3 (without the Current Velocity vectors).

Scene1

1. Select Insert in the Menu Bar and insert a new scene using the same file *MIKE_Animator_Example.dfs2*
2. Select the items bathymetry and current speed
3. Click the Scene in the Property Tree and select the Figure property page

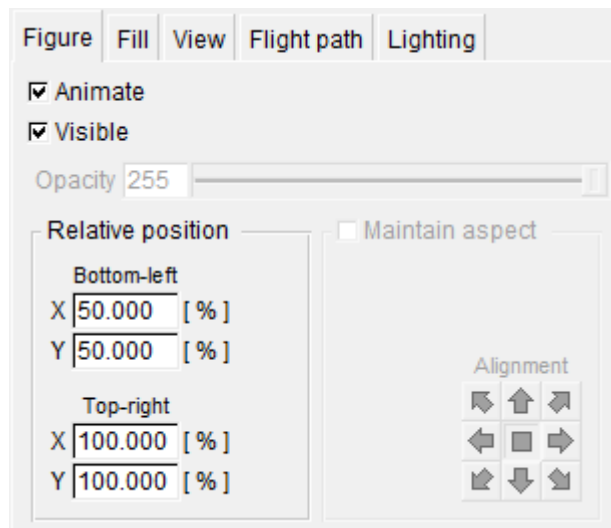

Figure 5.17 Figure property dialog for Scene2

4. Specify the *Relative position* of Scene1 so the view covers the upper right quarter area of the Graphics Window.
5. Enable animation in Scene1 by checking *Animate*.
6. Select *Current Speed* from the Property Tree
7. Select the Palette property page and define a range from 0.1 to 1.0.

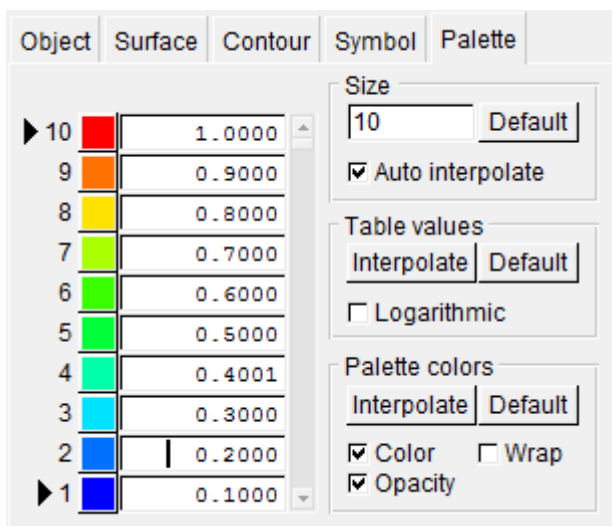

Figure 5.18 Palette property dialog

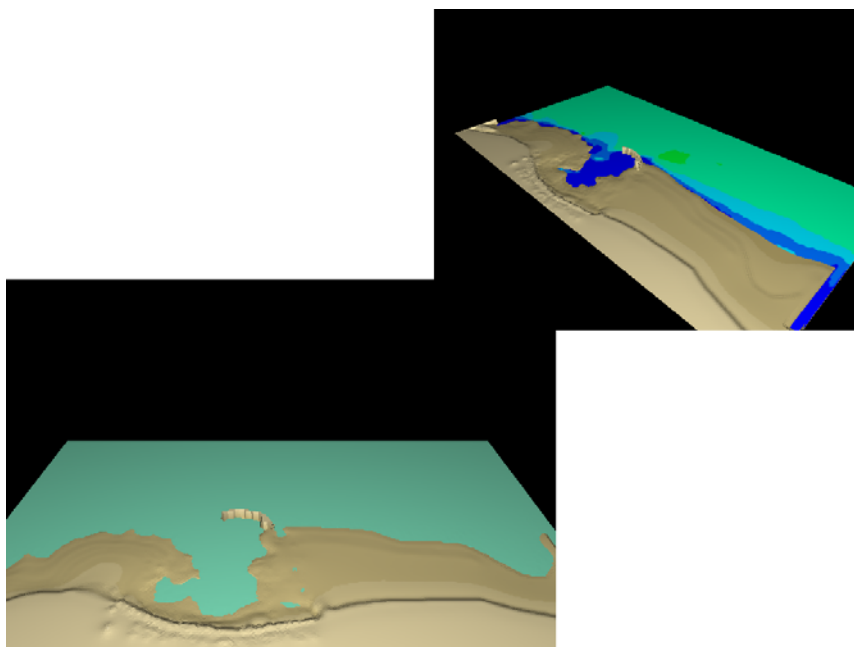

Figure 5.19 The Graphics Window after editing Scene1

5.4.3 Add 2D objects

Next step is to include the 2D objects to the Graphics View. First insert a headline:



1. Select Insert in the Menu Bar and insert a Text object
2. Click the Text object in the Graphics Window and drag it to a position in the upper left corner
3. Click *Text* in the Property Tree and select the Text property page
4. Write an appropriate text for the *Caption* and set the *Color* to Blue
5. Select the Fill property page and un-check *Solid Fill* in order to have a white background for the text.

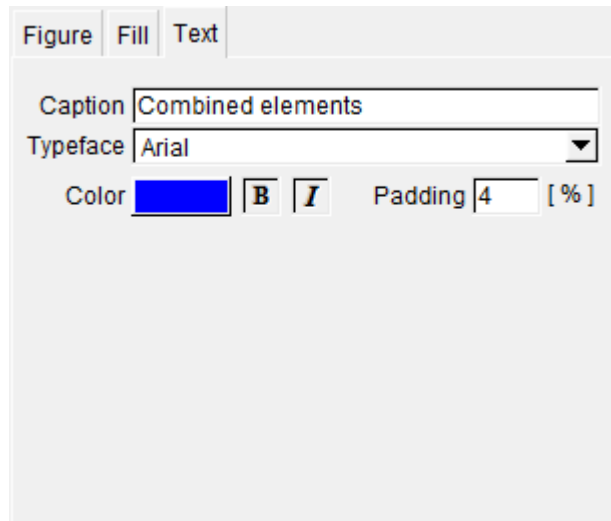

Figure 5.20 Text property dialog

Next insert a color legend for the flow velocities in Scene1:

6. Select Insert in the Menu Bar and insert a Legend
7. Click the Legend object in the Graphics Window and drag it to a position in the upper left corner (on top of Scene1)
8. Click *Legend* in the Property Tree and select the Legend property page

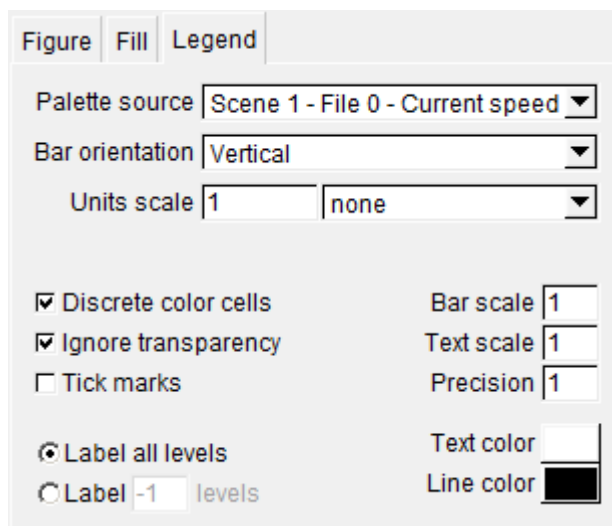

Figure 5.21 Legend property dialog

9. Set the *Palette source* to the Current speed from Scene1
10. Set the *Precision* to 1 to have one digit on the numbers in the legend

Finally insert a clock to display the time during animation:

11. Select Insert in the Menu Bar and insert a Clock object
12. Click the Clock object in the Graphics Window and drag it to a position below the headline
13. Click *Clock* in the Property Tree and select the Clock property page
14. Define the source of the *Figure* to be *Layout (all figures)*



Combined elements

0000-00-00 00:00:00

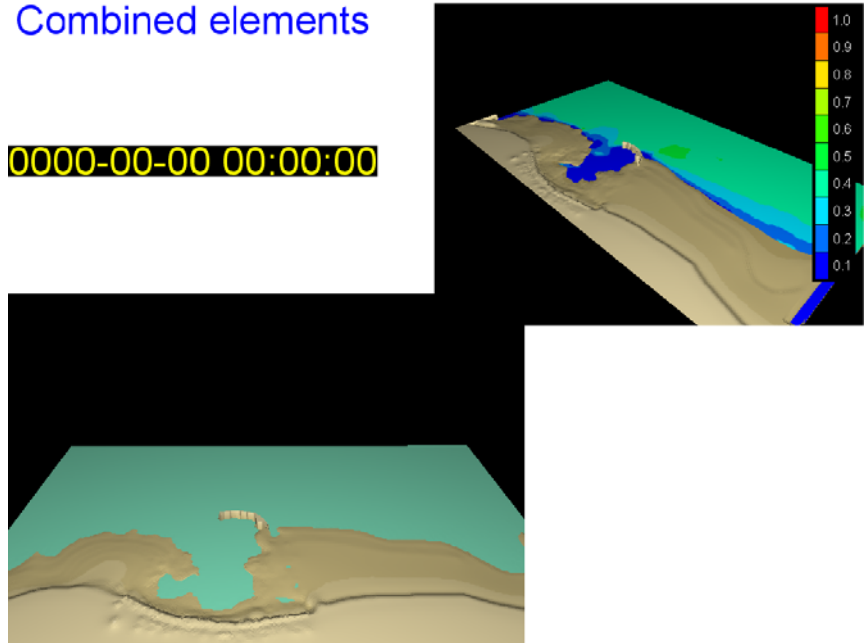

Figure 5.22 Graphics Window after defining all elements

5.4.4 Show animation

Finally, before you can show the combined animation you must remember to synchronize all the scenes so they start playing simultaneously.

1. Click Layout in the Property Tree and select the Animation property page
2. Check the *Time Synchronisation* and define the *Time step* to 30 minutes

The scenes will be animated simultaneously with the clock showing the actual time. A screen dump of a time step is shown in Figure 5.23.



Combined elements

1998-10-07 16:45:00

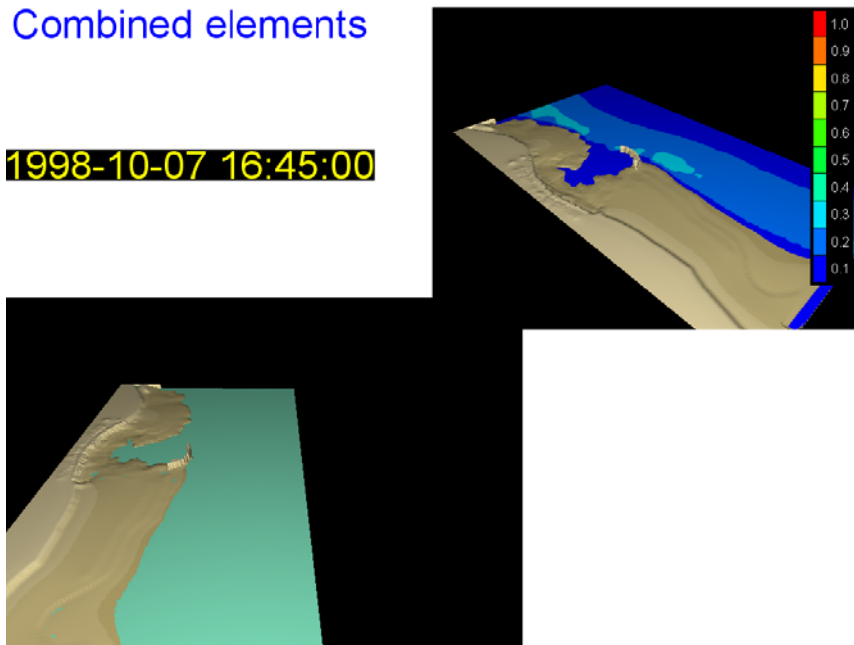

Figure 5.23 Screenshot of Graphics Window during animation

5.5 Image Draping

The following example provides you with an introduction on how to drape geographical referenced images over selected bathymetries.

5.5.1 Open MIKE Animator Plus

Select 'MIKE Animator Plus' from the Start menu. This will open the MIKE Animator Plus interface with an empty Graphics Window.

5.5.2 Load bathymetry data

Now load your bathymetry data file into MIKE Animator Plus as follows:

- From the Menu Bar select Insert → Scene...

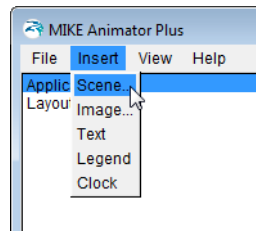

- Select *Oresund.mesh* from the MIKE Animator Plus example directory `.MIKEAnimatorPlus\Examples\Draping`.

The mesh file will now be added to the Property Tree and a (still empty) outline of the domain encompassing the model area is shown in the Graphics Window.

- Select the file name in the Property Tree and in the File property page-double-click the *Bathymetry* variable to include the item in the display.

The mesh data will load and be displayed in the Graphics Window, see Figure 5.24.

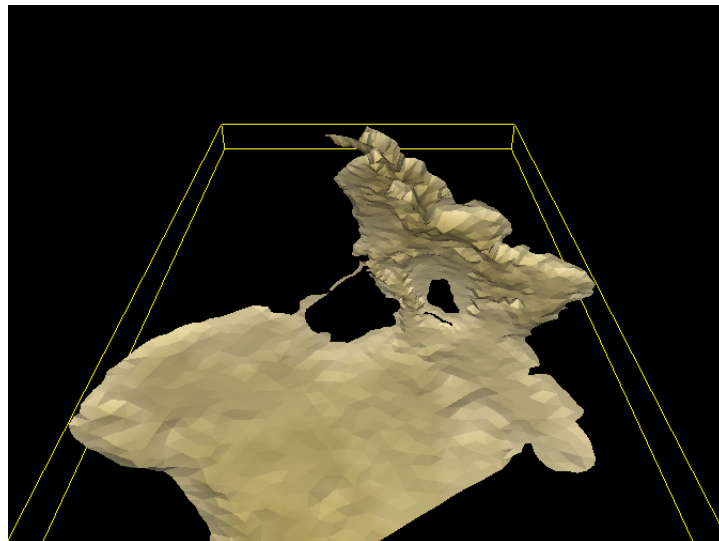
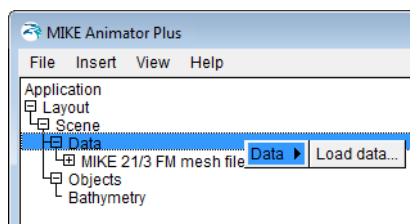

Figure 5.24 Graphics Window showing imported mesh file

5.5.3 Load georeferenced image

Now load your geographical referenced image into MIKE Animator Plus as follows:

- From the Property Tree select the Data for the scene and right-click. You now get the opportunity to load data into the existing scene.



- Select *Oresund.bmp* from the MIKE Animator Plus example directory `.MIKEAnimatorPlus\Examples\Draping`.

The spatial image file will now be added to the Property Tree.

- Select the spatial image file name in the Property Tree and in the File property page double-click the *Orthoimage* variable to include the item in the display.

The image data will load and be displayed in the Graphics Window, see Figure 5.25. Per default the image will be shown draped to the level 0 m. In this case the mesh bathymetry values is below 0 m and therefore is hidden under the image.



Figure 5.25 Graphics Window showing imported image file

5.5.4 Adjust draping

You specify the image to be draped onto the surface of the bathymetry as follows:

- From the Property Tree select the Orthoimage object



- View the Image property page, click the Drape to surface drop-down list and select the object 'File 0 - Bathymetry' to drape the georeferenced image upon.

The image data will now be draped to the existing surface. Areas of the image that are not located within a valid surface area will not be displayed, see Figure 5.26.

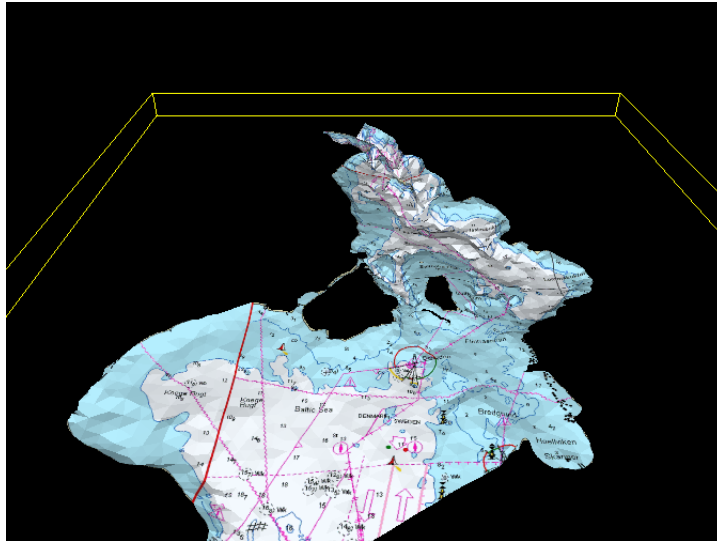

Figure 5.26 Graphics Window showing imported image file draped upon mesh bathymetry surface

It is possible to select to drape the image onto land only (surface levels above a specified land value) or onto basin only (surface levels below a specified land value). Figure 5.27 shows examples of image draping when considering the land value. The bathymetry surface in this instance is the file *Sound-Bathy900_1.dfs2* located in the MIKE Animator Plus example directory *.\\MIKEAnimatorPlus\\Examples\\Draping*.

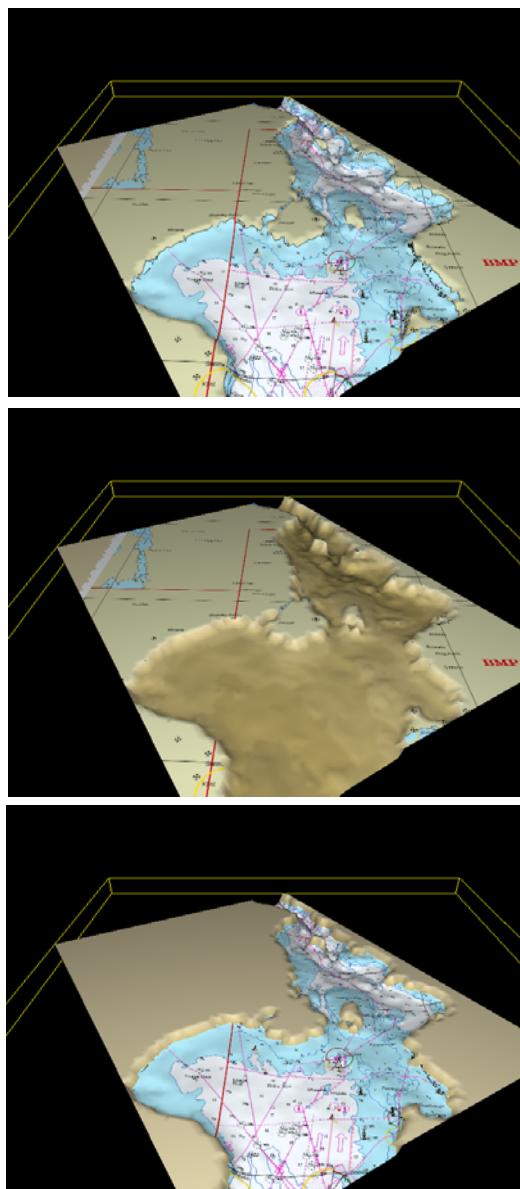

Figure 5.27 Examples of draping on dfs2 bathymetry
Upper: Draping to entire surface
Middle: Draping to land only (> 0 m)
Lower: Draping to basing only (< 0 m)

Note that the draping only works on bathymetry elements that actually holds a value. I.e. if the cell element holds a delete value, the image data will not be draped in that particular element. An example of this is visualized in Figure 5.28 where the georeferenced image RRectifyGESnapshot.jpg is draped upon the bathymetry file City.dfs2. The files used for this example is



located in the MIKE Animator Plus example directory `.MIKEAnimator-Plus\Examples\Draping`.

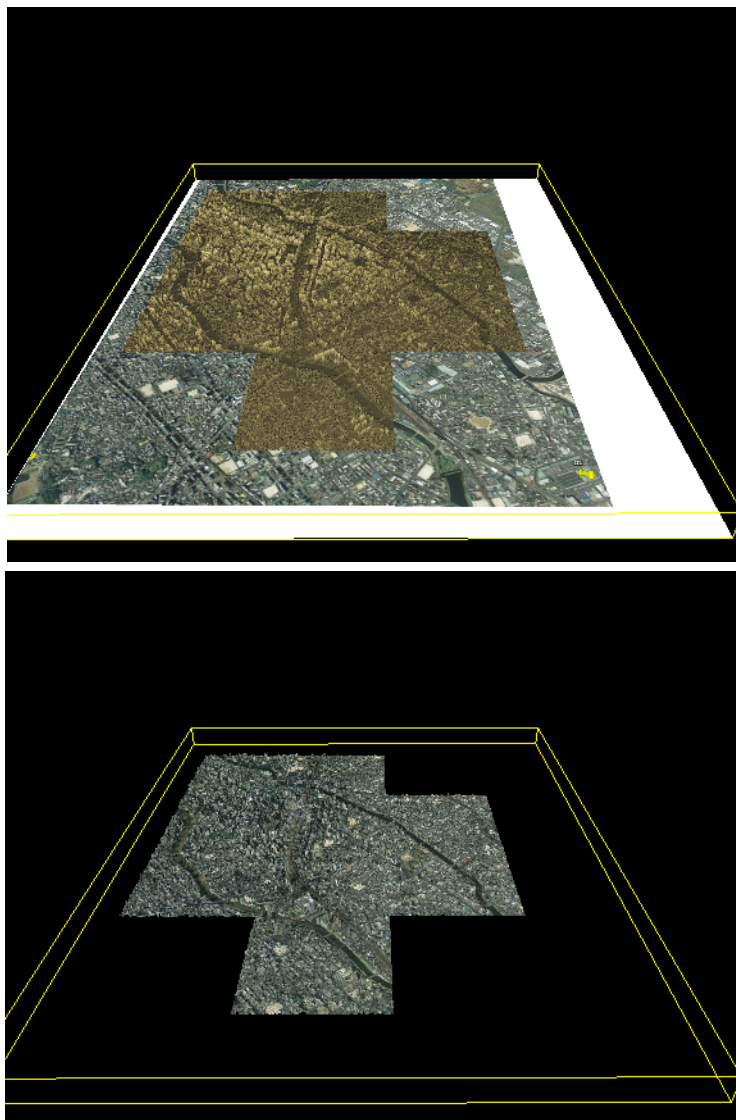

Figure 5.28 Example of draping on dfs2 bathymetry with delete values
Upper: Georeferenced image not draped to surface
Lower: Georeferenced image draped to bathymetry surface

5.6 Basic Solids

MIKE Animator Plus contains the possibility of including and visualizing 3D studio solids in a user-defined location in the domain.



A 3D studio solid can be used to e.g. visualize ship movements or a structure component such as a bridge pillar.

5.6.1 Open MIKE Animator Plus

Select 'MIKE Animator Plus' from the Start menu. This will open the MIKE Animator Plus interface with an empty Graphics Window.

5.6.2 Load bathymetry data

Now load your bathymetry data file into MIKE Animator Plus as follows:

- From the Menu Bar select Insert → Scene...
- Select *bathy.dfs2* from the MIKE Animator Plus example directory *.\MIKEAnimatorPlus\Examples\BasicSolids*.
- Select the Depth item

Now a flat surface is shown in the display (in this instance it is a constant bathymetry value of -10m in a domain covering 100 m x 100 m).

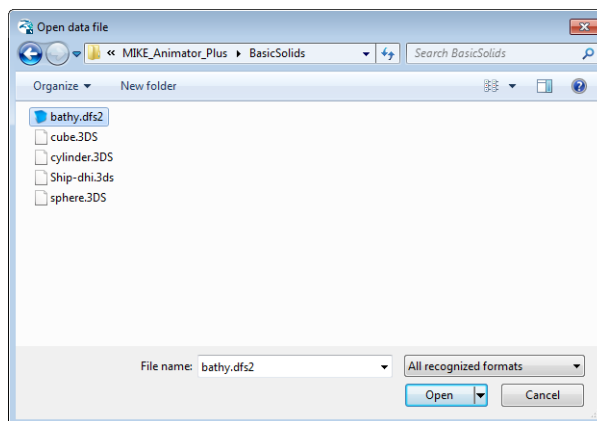

Figure 5.29 Select file to display

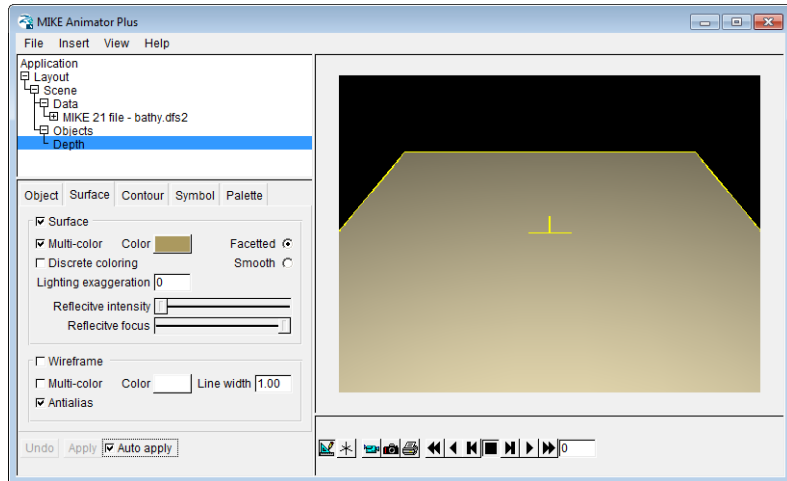

Figure 5.30 Select and create surface

5.6.3 Load solid

A 3D studio is handled similar to other object components with respect to adding the solid. Select Scene to add more objects.

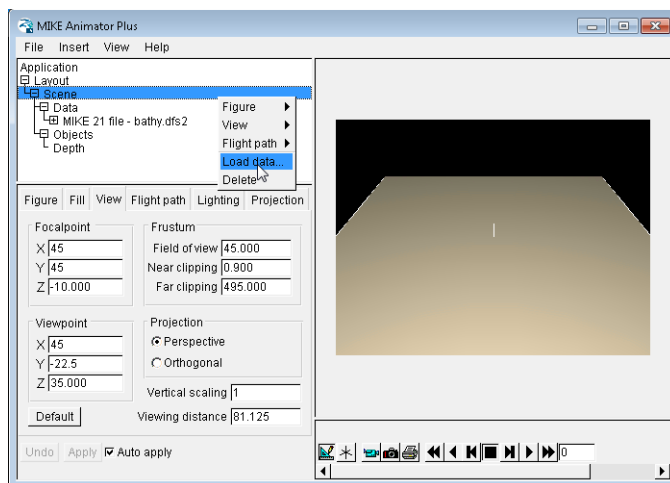

Figure 5.31 Scene and right-click to add data

- Select existing scene and add *cube.3ds* from the MIKE Animator Plus example directory `\\MIKEAnimatorPlus\\Examples\\BasicSolids`
- Select the Variable 'Solids Model'

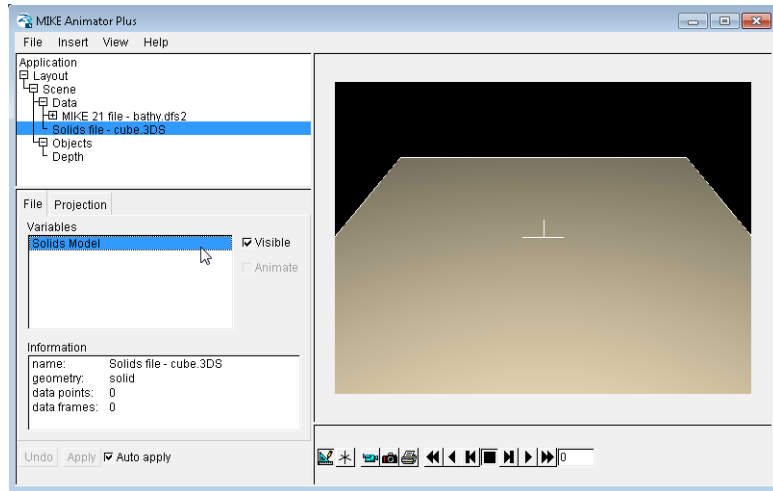

Figure 5.32 Select the variable to show the solid

The solid is initially entered into the centre of the domain, using a default size. This may result in the solid being difficult to see in the display. Often you need to place and scale the solid before a reasonable display is reached.

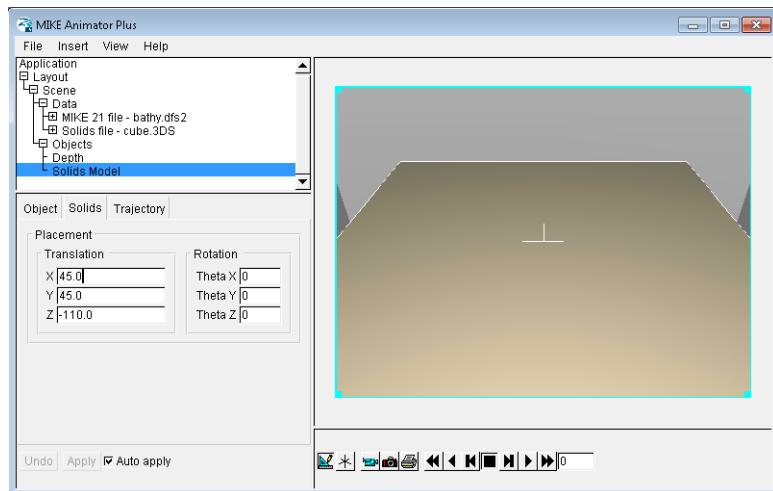

Figure 5.33 Initial display of solid

Next place the solid in position (25,25,0) and set the size of the cube sides to 10 m. If a number of solids are to be included you can rename the object to e.g. Cube for easier identification.

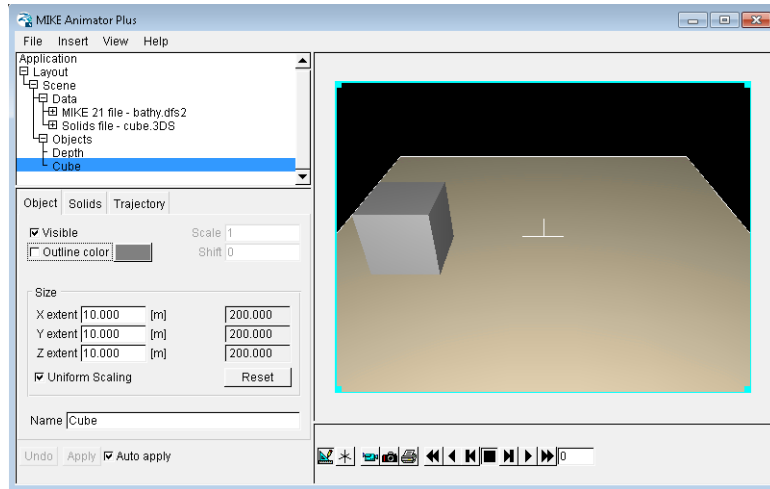

Figure 5.34 Resulting display of solid after re-positioning and re-sizing.

5.6.4 Solids in installation

The same installation example contains other 3D studio solids such as a cylinder, a sphere and a ship. These can be included in the same scene using the same procedure as described above.

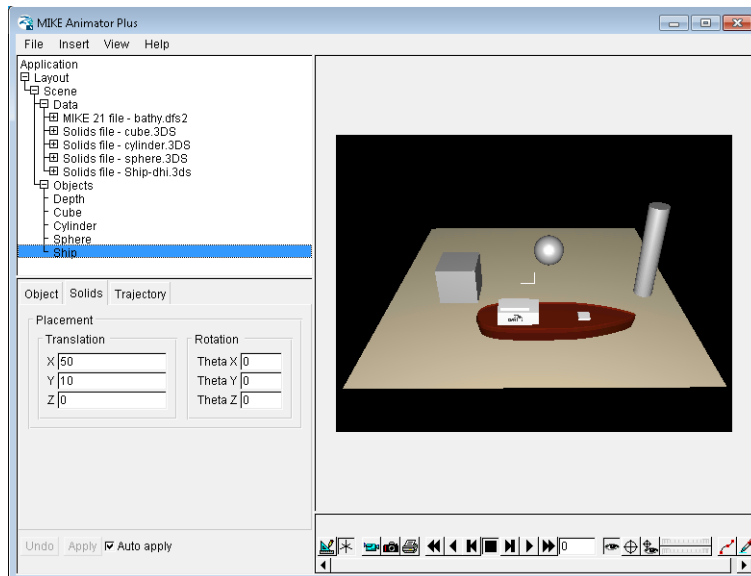

Figure 5.35 Example of solids in the display

5.6.5 Rotating solid

Besides moving the solid in the horizontal and vertical direction it is also possible to rotate the solid around the three axis. This is done together with the placement of the solid. E.g. to change the orientation of the ship you can rotate the solid around the z-axis as shown in Figure 5.36. To define a moving solid you need to import a trajectory as shown in the next example described in this guide.

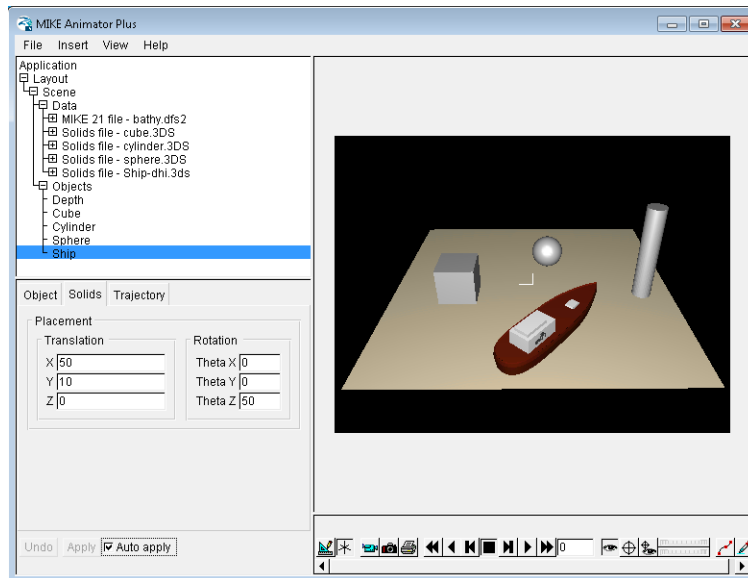

Figure 5.36 Example of rotated 3D solid

5.7 Using Solids

The following example provides you with an introduction on how to include a moving 3D Solids in a scene.

5.7.1 Open MIKE Animator Plus

Select 'MIKE Animator Plus' from the Start menu. This will open the MIKE Animator Plus interface with an empty Graphics Window.

5.7.2 Evaluate 3D solid design

To evaluate the appearance of the 3D solid it is recommended to first load the solid into an empty scene.



- Select Insert in the Menu bar and insert a scene using the 3D solid file *Ship-dhi.3ds*.
- Select and double-click the variable *Solids Model* to include the solid in the display
- Select the scene mode and use the moving cursor to view the solid from all sides

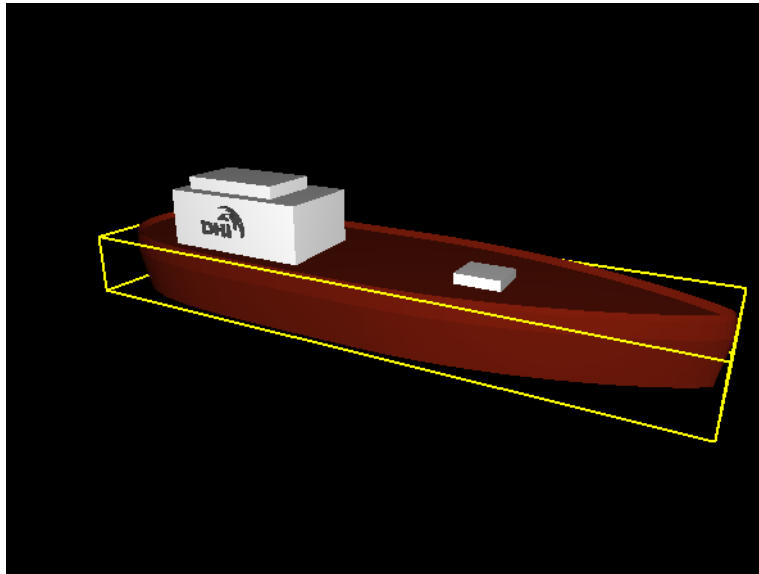

Figure 5.37 Visualising 3D solid in Graphics Window

- Evaluate and make note of the size of the solid in the local coordinate system

5.7.3 Load modelling results in new scene

Having investigated the 3D solid and determined that this is the one to use, you can start over and create a new scene with the bathymetry and surface level information.

- Select Insert in the Menu bar and insert a scene using the file *hd.dfsu*.
- Select the items Bathymetry and Surface level.

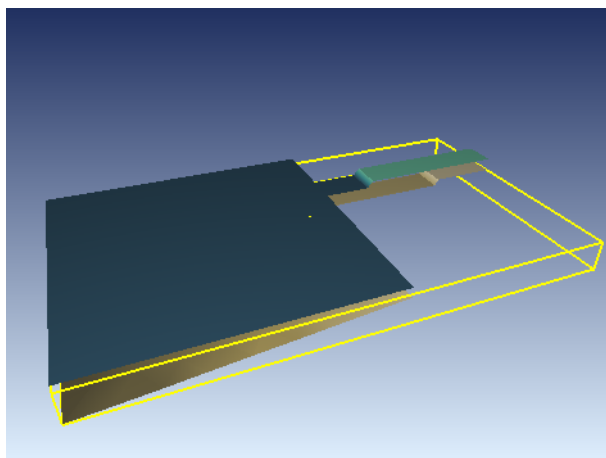

Figure 5.38 Graphics window showing imported dfsu file

The displayed data represent a canal with a sluice that is connected to the sea.

- Enable Animation for the scene and try to animate the display to see how the water within the sluice drop to sea level.

5.7.4 Load 3D solid into existing scene

Now load in the solid into the existing scene and scale the size accordingly.

- Select existing scene and load in the solid
- Re-scale the solid so the extent match the measure unit used in the coordinate system for the loaded dfsu file



Object	Solids	Trajectory
<input checked="" type="checkbox"/> Visible		Scale 1
<input type="checkbox"/> Outline color 		Shift 0
Size		
X extent	<input type="text" value="11.308"/> [m]	<input type="text" value="1408.534"/>
Y extent	<input type="text" value="3"/> [m]	<input type="text" value="373.669"/>
Z extent	<input type="text" value="2.391"/> [m]	<input type="text" value="297.827"/>
<input checked="" type="checkbox"/> Uniform Scaling		<input type="button" value="Reset"/>
Name <input type="text" value="Solids Model"/>		

Figure 5.39 Object property dialog to scale 3D solid

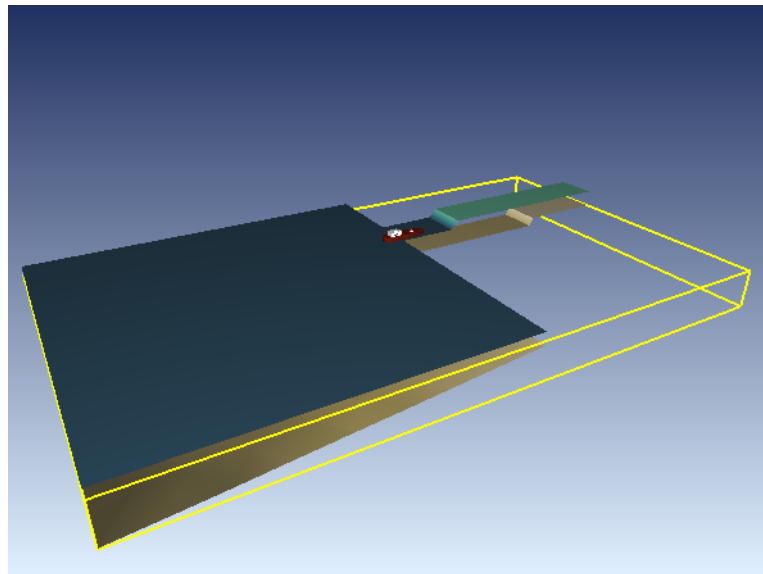

Figure 5.40 Graphics window after adding and scaling 3D solid

5.7.5 Position 3D solid for initial time step

Next move the solid to the position of the sluice.

- Position the focal point to (x,y,z) position (25, 5, 0) which is located in the middle of the sluice



- Zoom to the canal area, where you can just see the solid in the initial placement
- Position the solid at the focal point by typing the (x,y,z) position into the property dialog.

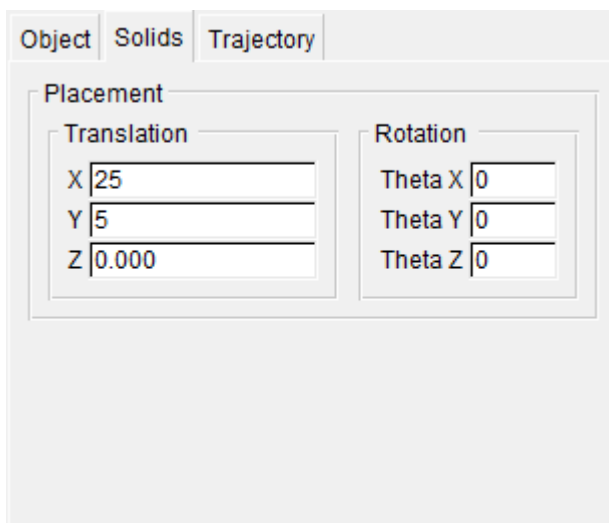

Figure 5.41 Solids property dialog to place solid in the domain

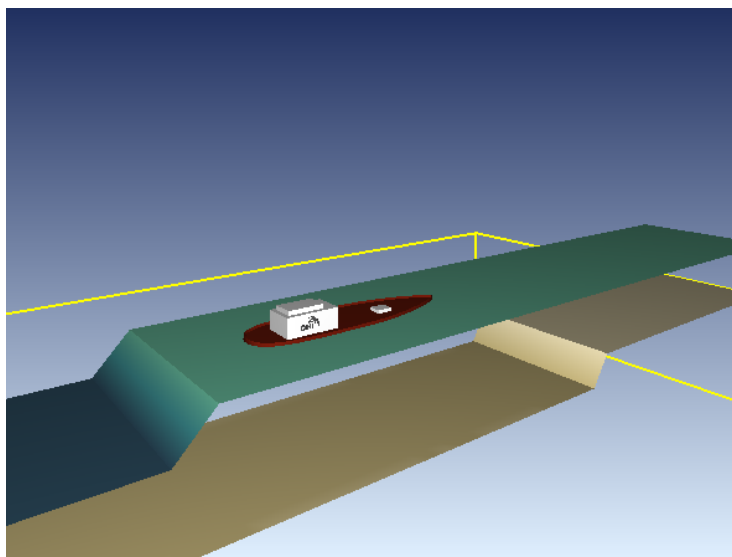

Figure 5.42 Graphics window after moving the solid

Per default the water surface is shown as opaque. In order to visualise the part of the solid that is below surface, you must make the water surface transparent.



- Select the color palette for the water surface and double-click color box for upper level. Reduce the Alpha value to increase transparency. Then do the same for the lower level and interpolate the color palette so all the colors become transparent.
- Move the water surface object to the end in the Objects property page in order for the layer to display the solid through the transparent water surface.

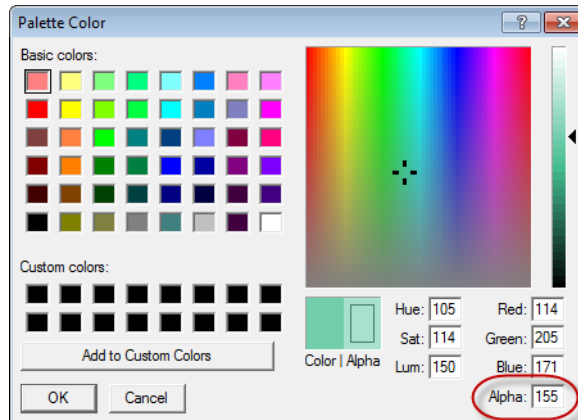

Figure 5.43 Modify Alpha value in palette to increase transparency

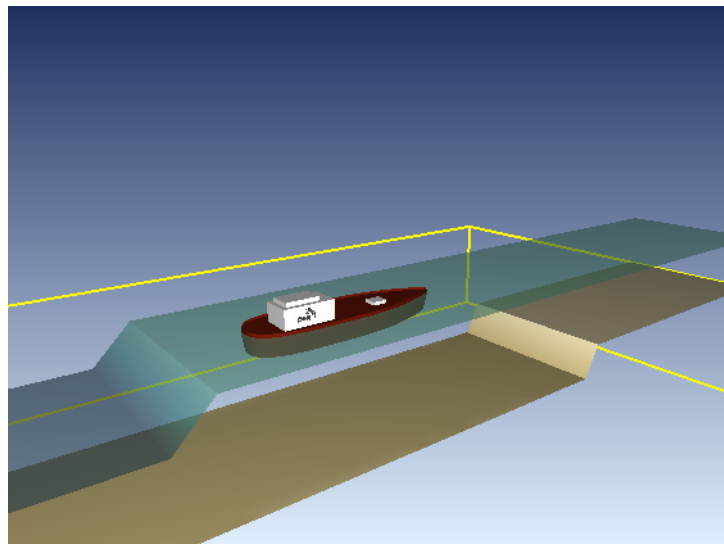

Figure 5.44 Transparent water surface showing submerged solid

You may have noticed that you cannot use the cursor to mark the translation values for the solid, as the functionality in this context instead will move the solid interactively around in the display.



- Now use the interactive movement for the z-value to position the ship at a higher water level, and rotate the solid 180 degrees around the z-axis to finalize the presentation.

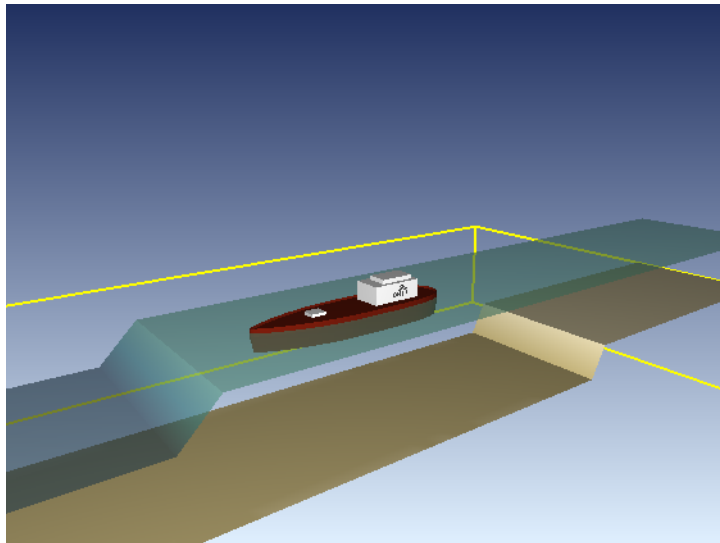

Figure 5.45 Graphics window after final modifications

- Enable Animation for the scene and try to animate the display. Note that the ship remains still in the initial location while the water level within the sluice drop to sea level.

5.7.6 Define trajectory for 3D solid

In order for the 3D model to move in the domain and follow the water level you have to define a trajectory, that defines the movement of the solid.

- Enable Dynamic on the Trajectory property dialog
- Select a 3-parameter movement with 0 for the correction angle
- Select the file 'Trajectory.dfs0'

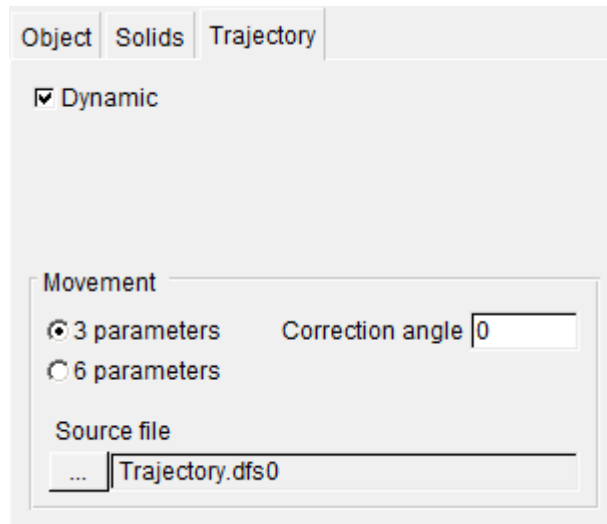

Figure 5.46 Trajectory property dialog to define movement of solid

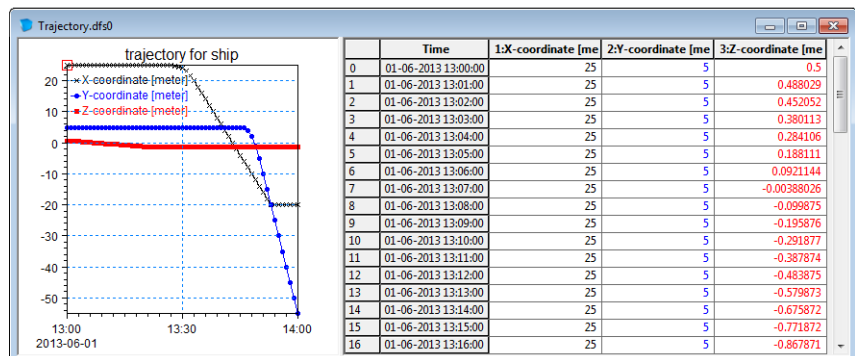

Figure 5.47 Trajectory.dfs0 as shown in MIKE Zero's Time series editor

- Enable Animation for the scene and try to animate the display to see how the ship moves downwards while the water level within the sluice drop to sea level. Once the water level has dropped to the sea level the ship moves out of the sluice and into the sea. You may have to zoom out in the display to be able to follow the ship in the domain.

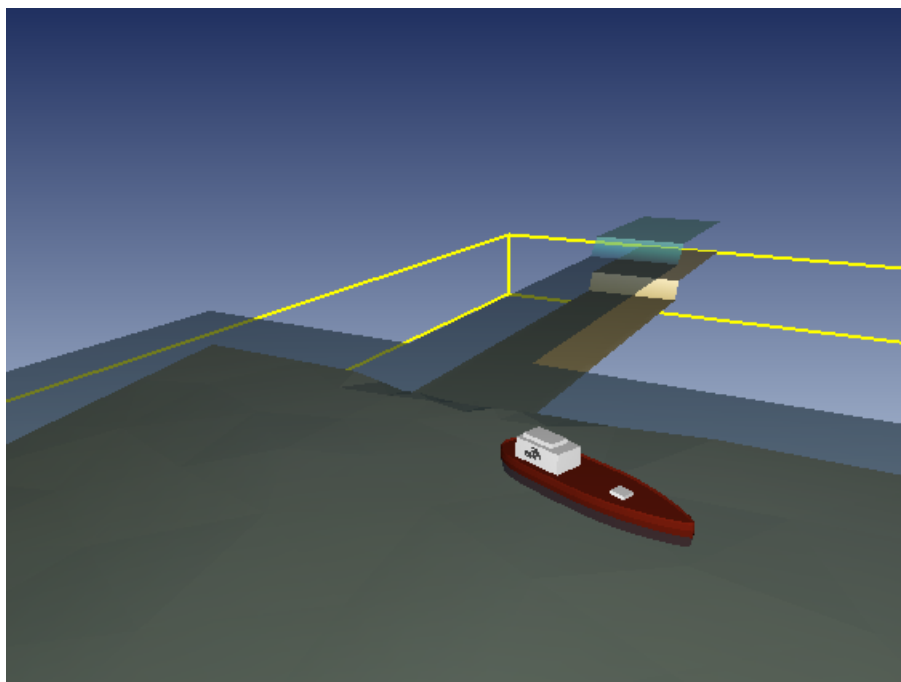

Figure 5.48 Graphics window showing ship movement

5.7.7 Import flight path

In order to follow the details of the ship movements it is feasible to have a view point close to the ship while being in the sluice and a view point longer away when following the ship in the sea.

This can be obtained by using a flight path with View point coordinates that meets the requirements above, and focal point coordinates derived from the trajectory. Such a flight path as already been generated and are saved in the file 'FlightPath.fsp'.

- Goto the Flight path property dialog
- Right-click the 'Flight path' tab and select the file 'FlightPath.fsp'. This will load in the flight path and show the flight path outline in the domain.

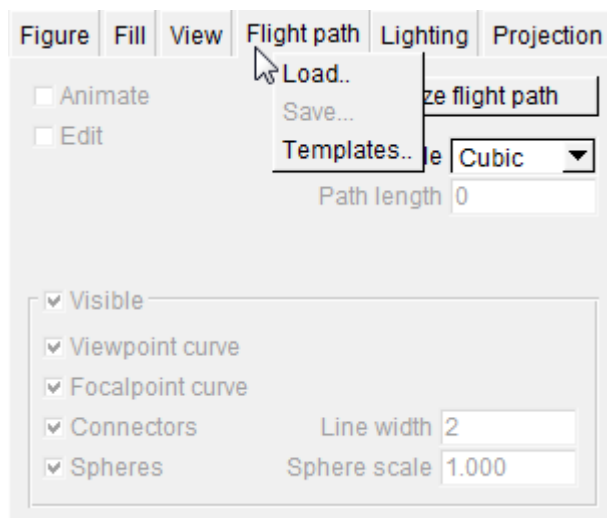

Figure 5.49 Selecting to load existing flight path file

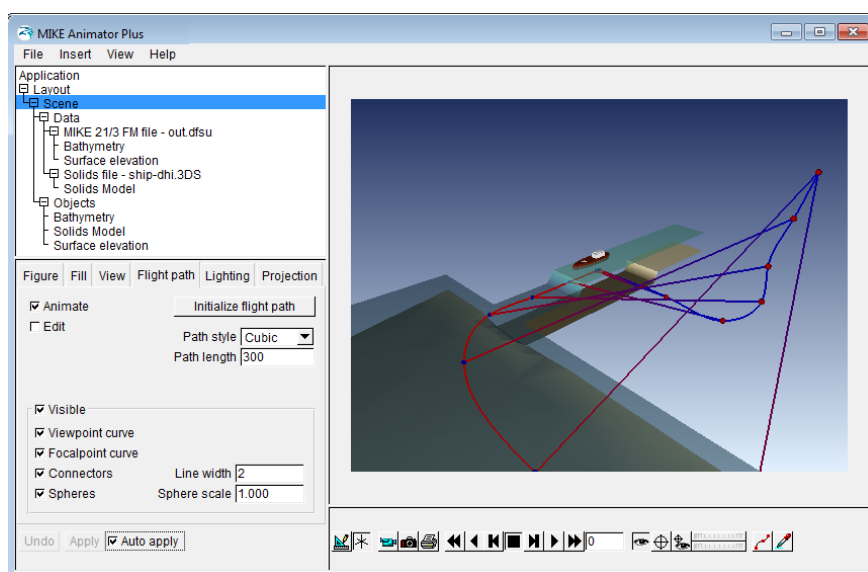

Figure 5.50 Outline of imported flight path

- The dfsu file contains 60 time steps. In order to make the flight path information match the movements of the ship, change the default Path length of 300 to 60.
- For presentation graphics disable the visualisation of the flight curves
- Do a forward and backward step in the animation toolbar to show time step 0 based on the flight path definition.

- Animate the display and see how the view point changes while the focal point are pointed to the position of the ship.

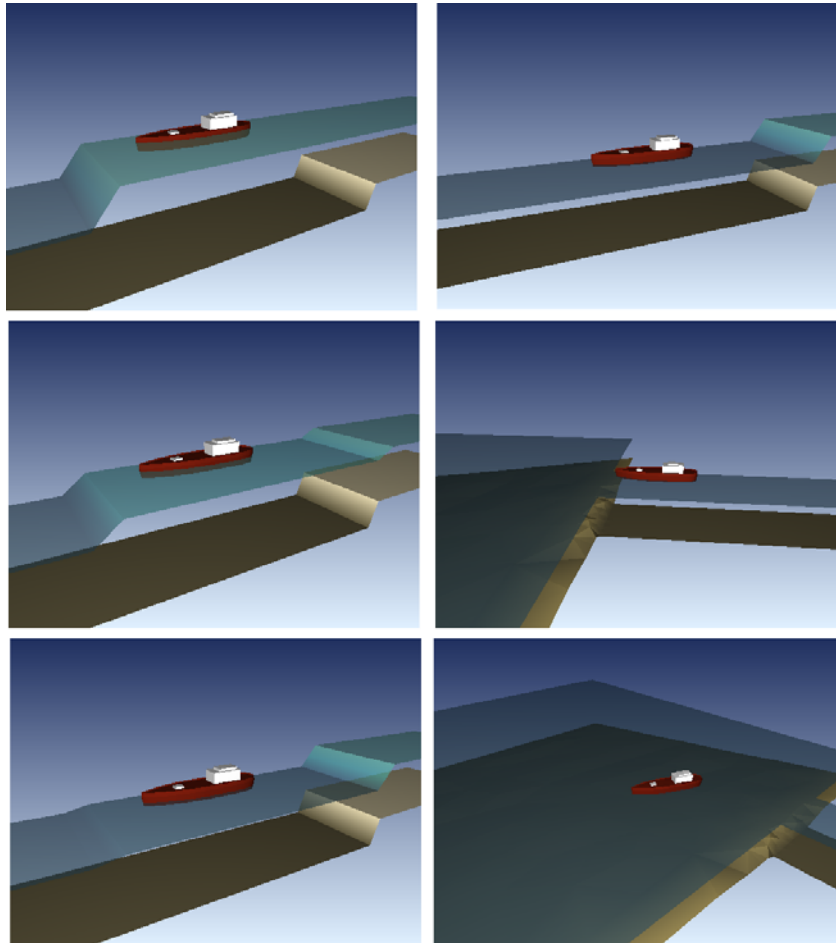

Figure 5.51 Graphics window during simulation
Left column: Time step 0, 10 and 20
Right column: Time step 30, 40 and 50

5.8 Displaying particles

The following example provides you with an introduction on how to include particles from a xml particle track file in a scene.

5.8.1 Open MIKE Animator Plus

Select 'MIKE Animator Plus' from the Start menu. This will open the MIKE Animator Plus interface with an empty Graphics Window.



5.8.2 Load dfs results into new scene

In order to initialize the time frame and provide a domain for the particles to be displayed against, first import a file with temporal variation.

- Select Insert in the Menu bar and insert a scene using the file *hd.dfsu*.
- Select the items Bathymetry and Surface elevation.
- Enable wireframe for the bathymetry
- Enable transparency of the water surface

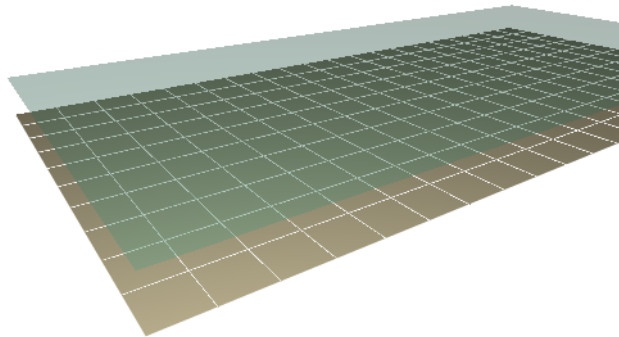

Figure 5.52 Graphics window showing imported dfsu file
Wireframe shows the individual grid elements to be 50m x 50m

The displayed data represent a closed water domain with constant water level. The depth is 50m.

5.8.3 Load particles into existing scene

The used particle track file describes 6 oil particles that were released from a position 1 m above the bed in the beginning of the simulation. The simulation considered wind drift that affected the particles when at the water surface.

Next load the particles into the existing scene.

- Select existing scene and load in the particle track file 'track.xml'
- Select the variable 'Diameter for equivalent circular slick'
- Modify the drawing order to draw the transparent surface elevation last.
- Select the particle to be represented by the symbol 'Disk'
- Disable multi-color and variable size



- Modify scale of symbol if necessary

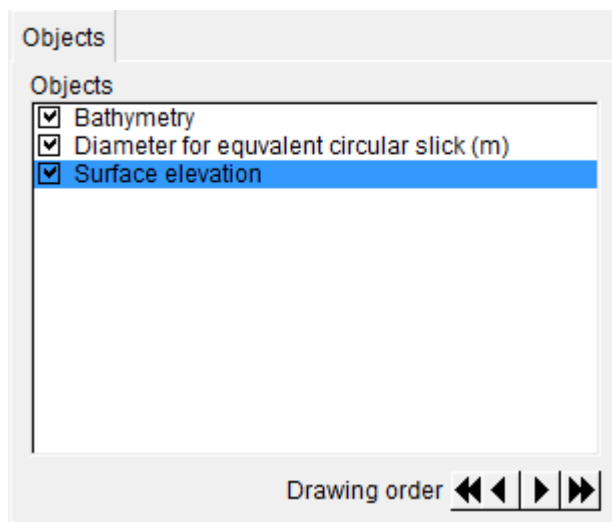

Figure 5.53 Modified drawing order of objects

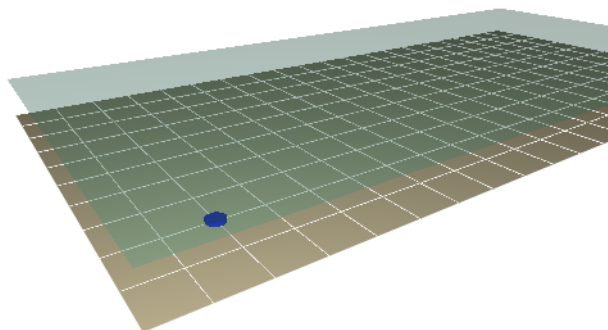

Figure 5.54 Initial display of particle for time step 0.

5.8.4 Animate particles

- Enable animation for the scene and try to animate the display.

Note that the particles are released from the bed and rise towards the water surface (due to buoyancy). As the particles reach the water surface wind drift cause the particles to move towards the other end of the domain.

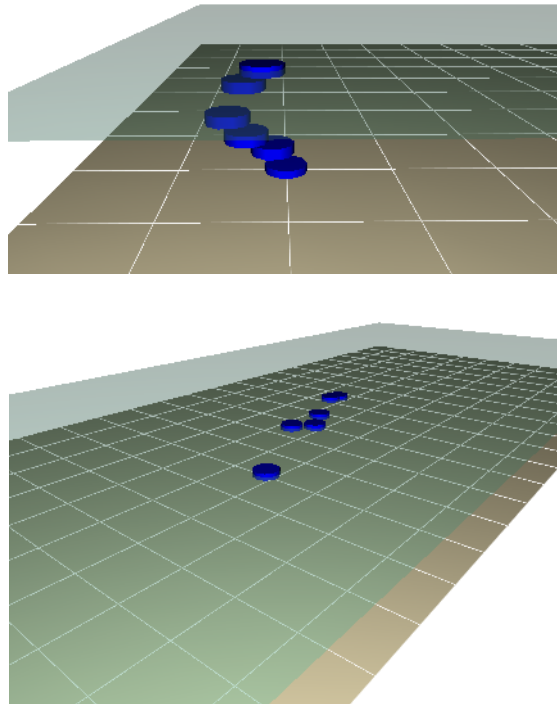

Figure 5.55 Display of particles during simulation
 Top: time step 60 (10 minutes), bottom: time step 180 (30 minutes)

5.8.5 Modify symbol layout

The symbol for the particles can be related to the actual value of the component by varying the size or color scheme (or both). In the present particle track file one of the components is the variable 'Diameter for equivalent circular slick'. This component is a spatial measure that can be illustrated in the domain by modifying the symbol size.

First it is necessary to calibrate the scale of the symbol.

- Change the view point and focal point to focus on the position of the outlet as shown in Figure 5.56.
- Modify the wireframe on the bathymetry to become more enhanced.
- Display time step 2. This will show a particle that should represent a diameter value of approx. 25 m.



Figure	Fill	View	Flight path	Lighting	Projection
Focalpoint		Frustum			
X	100	Field of view	45.000		
Y	100	Near clipping	1.000		
Z	-50.000	Far clipping	5500.000		
Viewpoint		Projection			
X	125	<input checked="" type="radio"/> Perspective			
Y	100	<input type="radio"/> Orthogonal			
Z	100	Vertical scaling	1		
Default		Viewing distance	212.132		

Figure 5.56 View properties for calibrating symbol size

- Change the Symbol display to enable 'Multi-color' and 'Variable size'
- Change the scale of the symbol until the size of the shown particle resembles a circle with a diameter of 25 m (equal to half the length of a mesh element)

Object	Symbol	Palette
<input checked="" type="checkbox"/> Symbol		
Type <input type="text" value="Disk"/>		
<input checked="" type="checkbox"/> Multi-color	Color	
<input checked="" type="checkbox"/> Filled	Line width	<input type="text" value="1.00"/>
<input checked="" type="checkbox"/> Antialias	Scale	<input type="text" value="2"/>
<input checked="" type="checkbox"/> Variable size	Orientation	<input type="text" value="0.00"/>
<input type="checkbox"/> Low resolution		

Figure 5.57 Properties for scaled symbol

It is found that a scaling factor of 2 gives the required result.

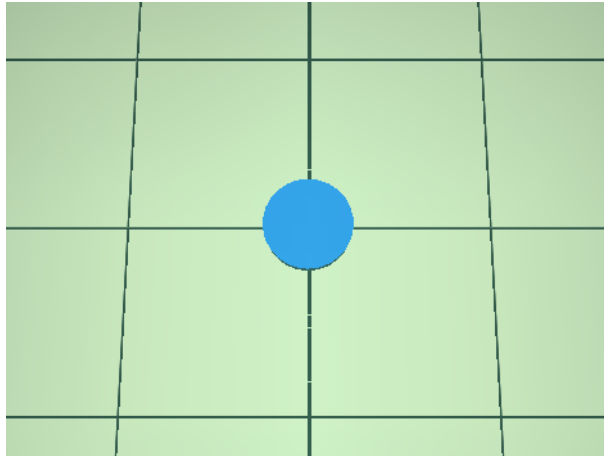

Figure 5.58 Particle at time step 2, visualising an oil slick with diameter 25 m.

When you display the particles using a variable symbol size and color, that reflects the values of the variable 'Diameter for equivalent circular slick', the display in Figure 5.55 changes to that in Figure 5.59.

Note that the effect of the oil spill becomes more apparent when scaling the particle size to the corresponding outline of the particle slick.

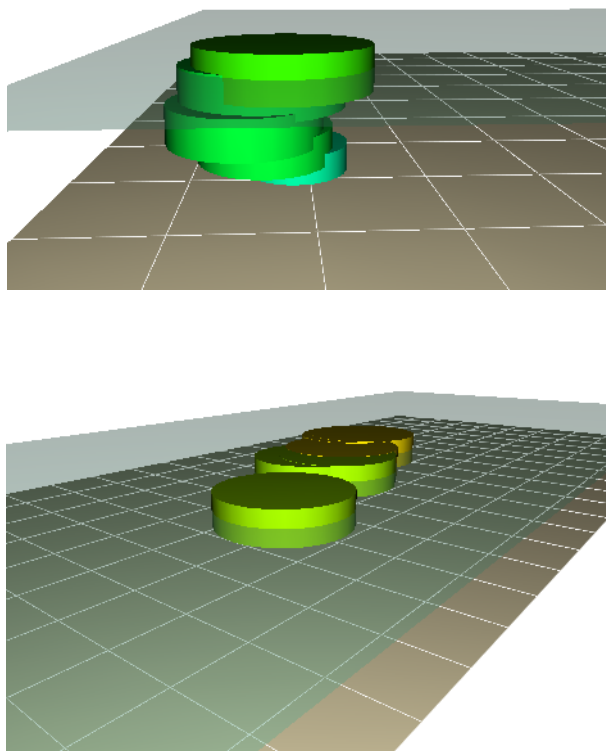

Figure 5.59 Display of scaled particles during simulation
Top: time step 60 (10 minutes), bottom: time step 180 (30 minutes)



6 Quick-Guide

This chapter describes how to apply basic functionalities in MIKE Animator Plus using step-by-step illustrations within a number of “how-to” examples.

Note that the highlighted subject in the property tree determines which property pages that are available.

6.1 How to select file and display file item

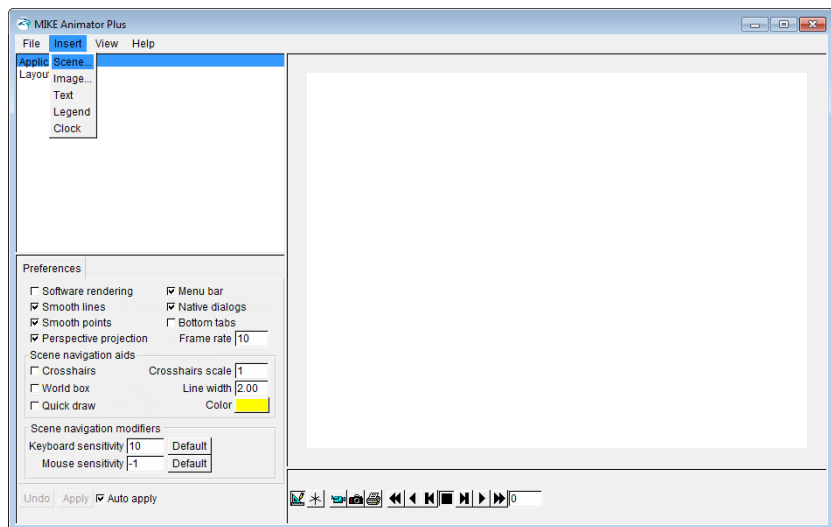

Figure 6.1 Select Insert → Scene

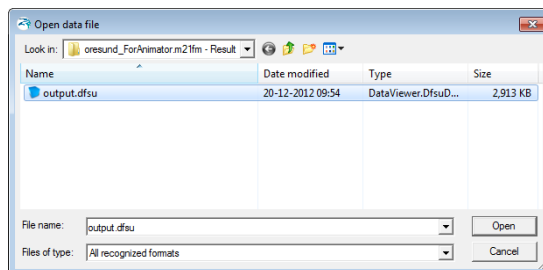

Figure 6.2 Select file

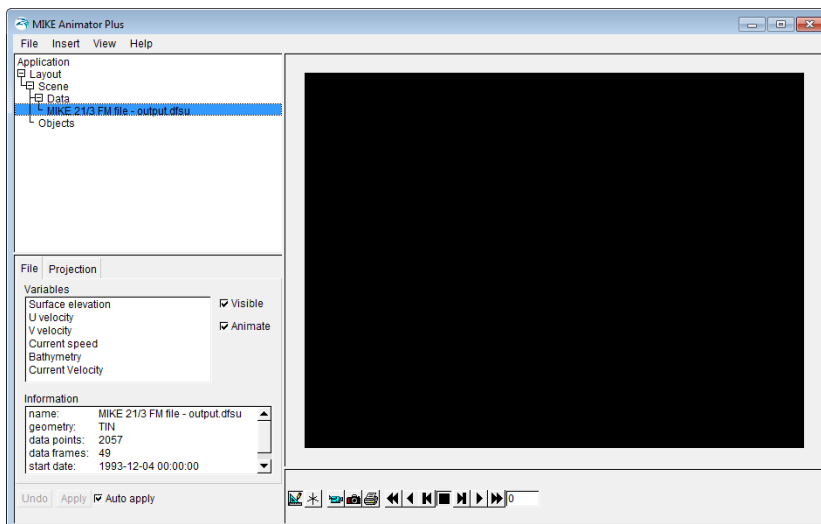

Figure 6.3 Highlight file in property tree

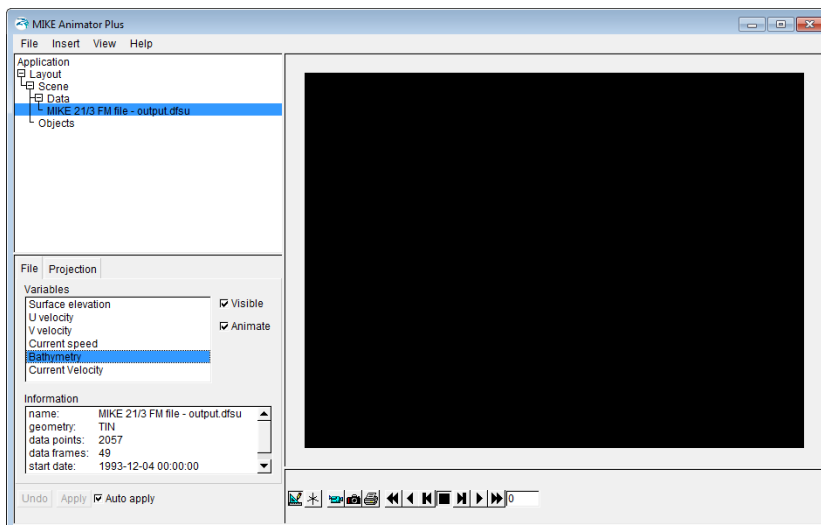

Figure 6.4 Highlight item on property page

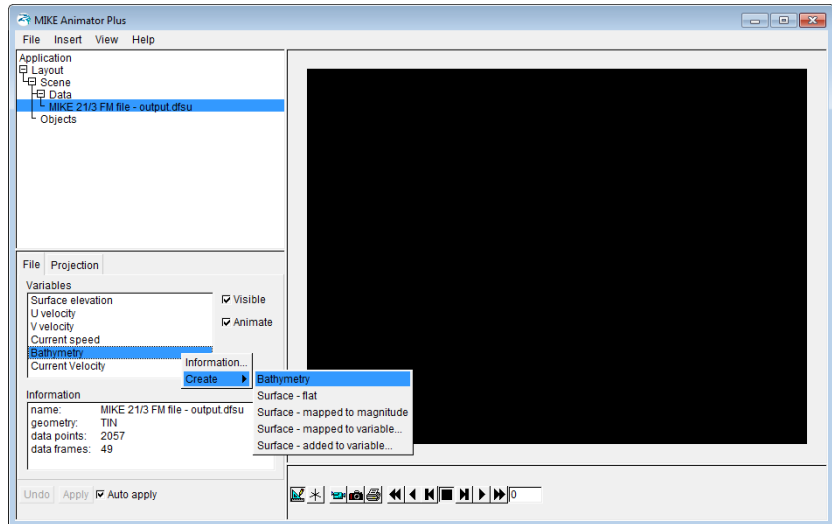

Figure 6.5 Right-click selected item to specify type of surface

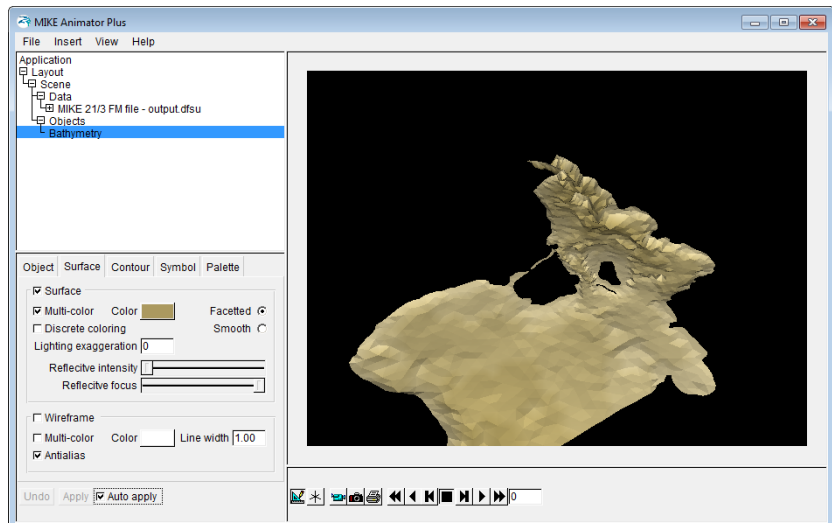

Figure 6.6 Resulting graphics window

6.2 How to control display properties

The display properties are controlled separately for the various layers and individual objects.

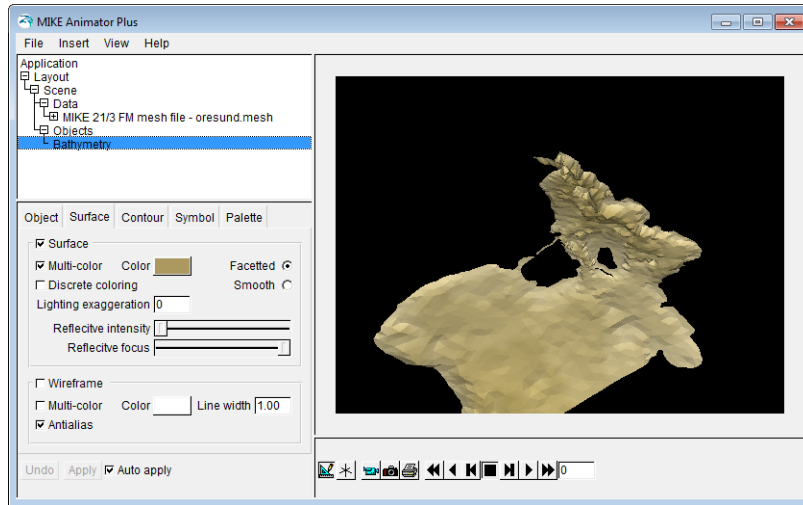

Figure 6.7 Initial setup with bathymetry

6.2.1 Background and scaling

To change the background you have to highlight the Scene and select the Fill property page. Herein you can modify the type of the background fill and the color(s).

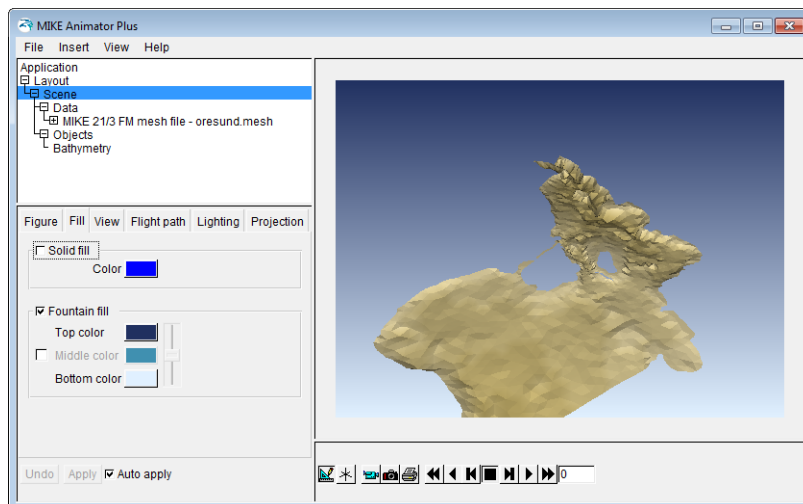

Figure 6.8 Fill property page: Background defined by Fountain fill

Per default the display will initially scale the vertical axis in a scene so the maximum difference in the vertical direction seems about 25 times smaller than in the horizontal direction. This can be modified on the View property page.

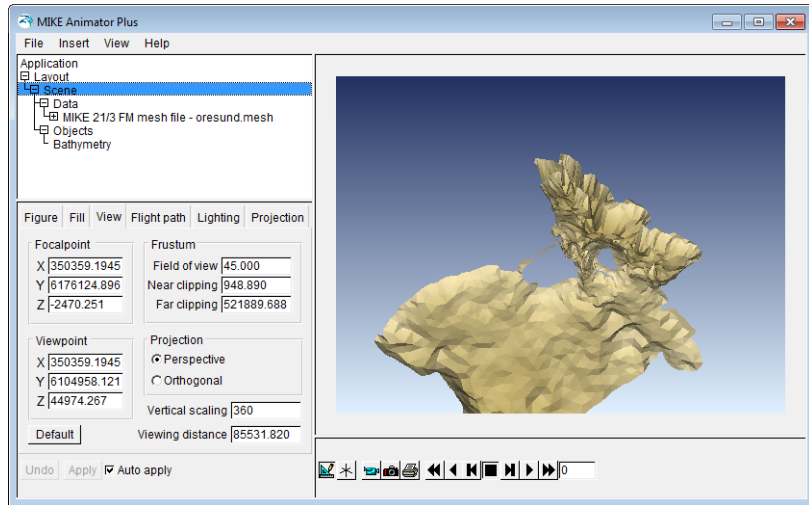

Figure 6.9 View property page: Vertical scaling increased to 360

6.2.2 Surface

To change the display of an item you have to highlight the item in the property tree and select the appropriate property page. The surface may be shown as faceted or smooth. This is defined on the Surface property page.

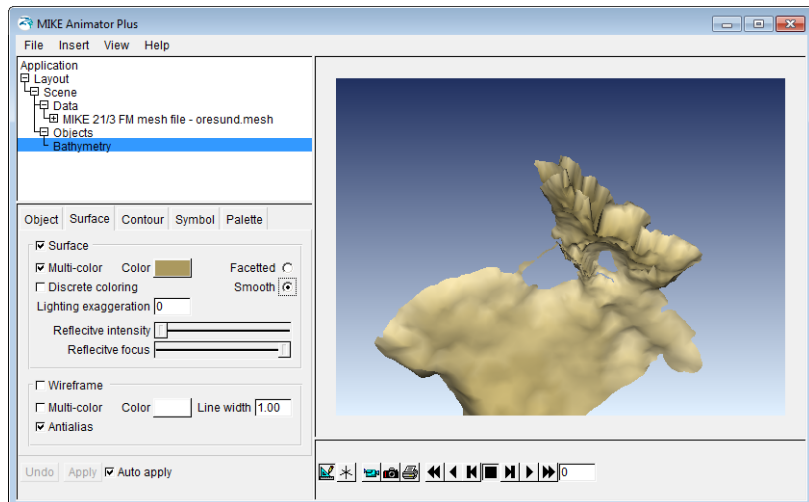

Figure 6.10 Surface property page: Surface is set to Smooth

In order to visualise the computational elements the surface can be overlaid with a wireframe of any given color.

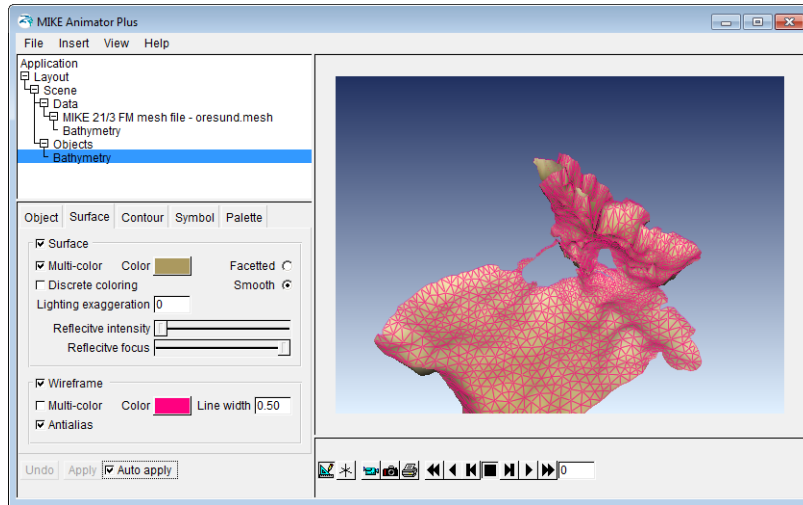

Figure 6.11 Surface property page: Wireframe overlay in pink.

6.2.3 Palette

When selecting the item the surface will be mapped by a default color palette. E.g. a bathymetry surface will be shown by earth colors whereas a surface mapped to magnitude per default is shown by a rainbow palette.

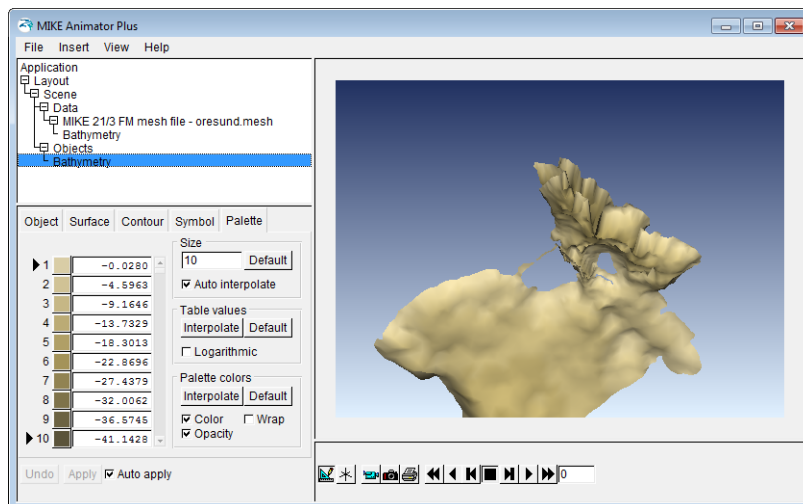

Figure 6.12 Palette property page: Default bathymetry color palette

It is possible to modify the palette by changing the colors directly in the palette or by right-clicking the item in property tree to load a saved palette or select a preset palette.

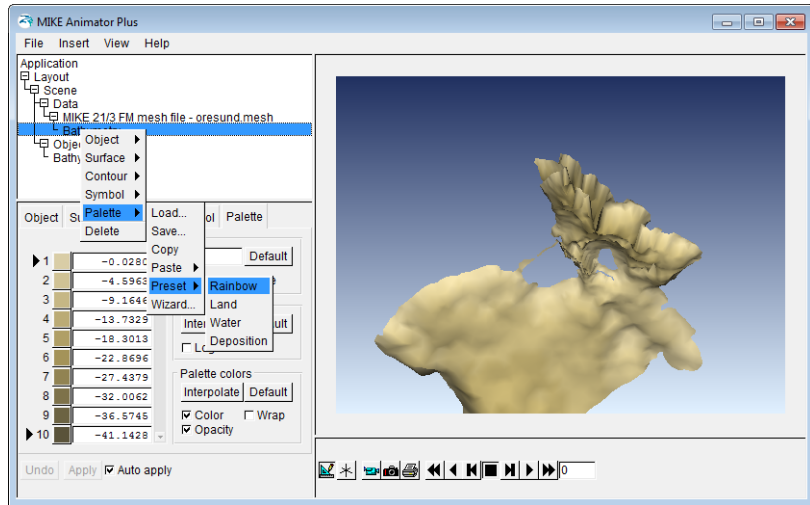

Figure 6.13 Manage palette from Property tree

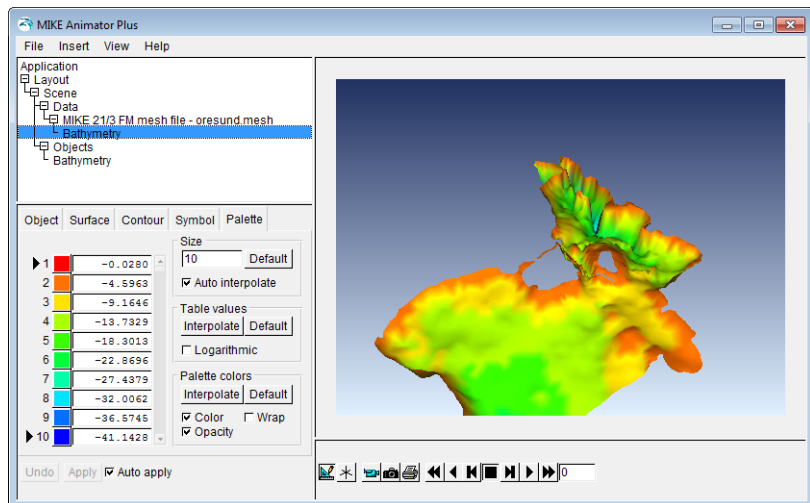

Figure 6.14 Bathymetry shown by preset rainbow palette

6.2.4 Contour

It is possible to show the item values by contour lines defined in the contour property page.

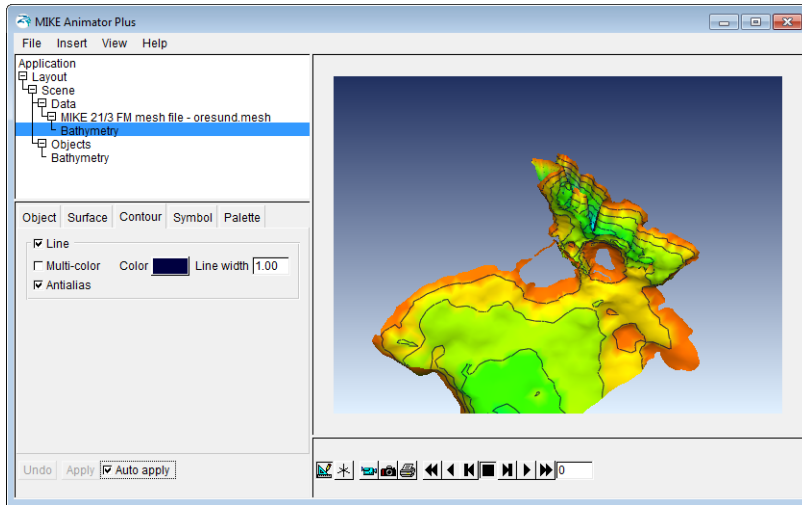

Figure 6.15 Contour property page: Displaying contour lines

6.2.5 World box

It is possible to change the preferences for the overall layout in MIKE Animator Plus. E.g. you can choose to show a world box that will enclose all data added to the layout.

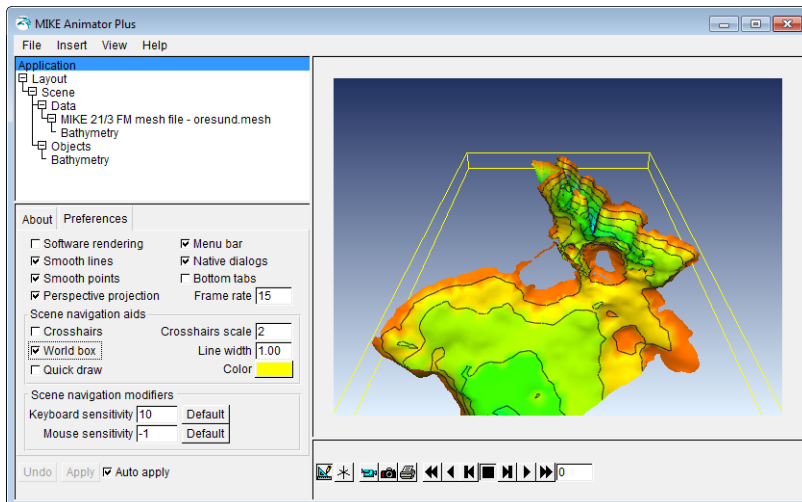

Figure 6.16 Preferences property page: Enabling world box



6.3 How to add 2D figures

It is possible to include additional information to the layout by using 2D figures such as text, legend and images.

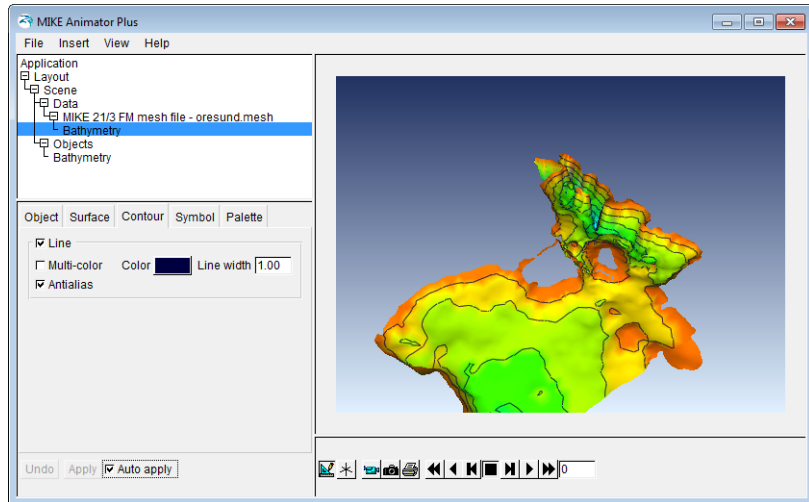

Figure 6.17 Initial setup

6.3.1 Text

A text string is useful for identifying the contents of the display.

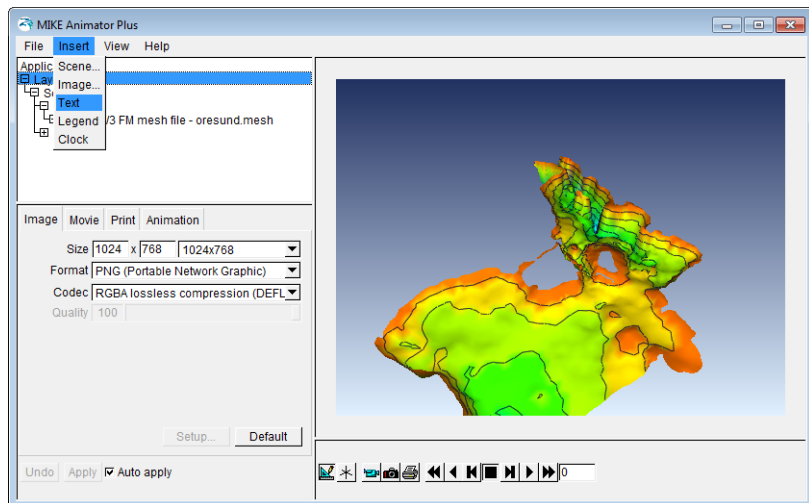

Figure 6.18 Select Insert → Text



Once added you may modify the fill for the text string by the Fill property page or move the string by 'dragging' the string in the display or specify the position directly in the Figure property page. The display for the string text itself is defined in the Text property page.

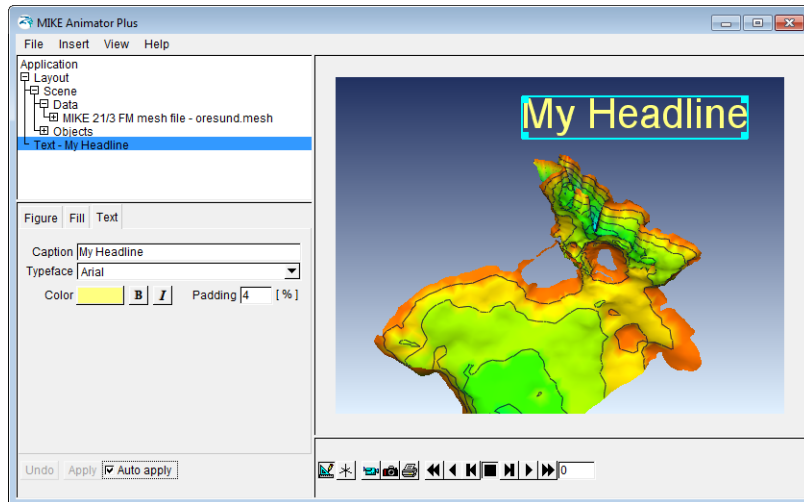

Figure 6.19 Text property page: Caption changed to “My Headline”

6.3.2 Legend

A color legend for the bathymetry shown in the display is added.

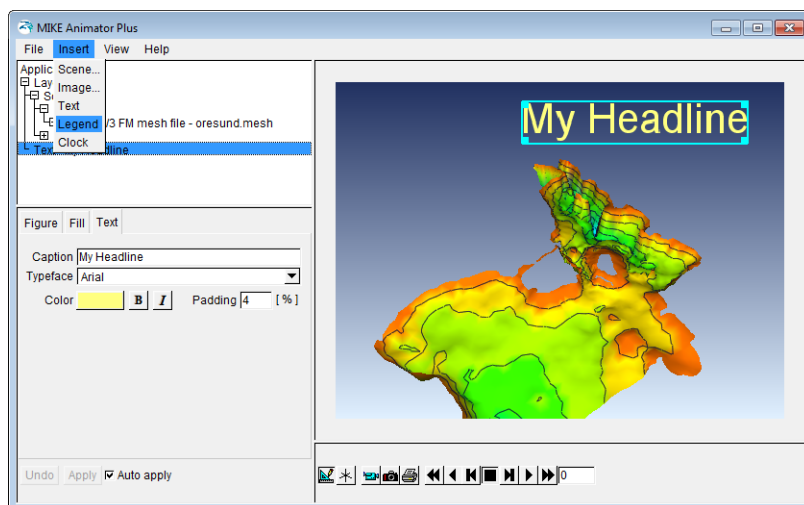

Figure 6.20 Select Insert → Legend



The legend values are derived from a user-defined item in the setup as specified on the Legend property page. Herein you can also modify the display of the color legend.

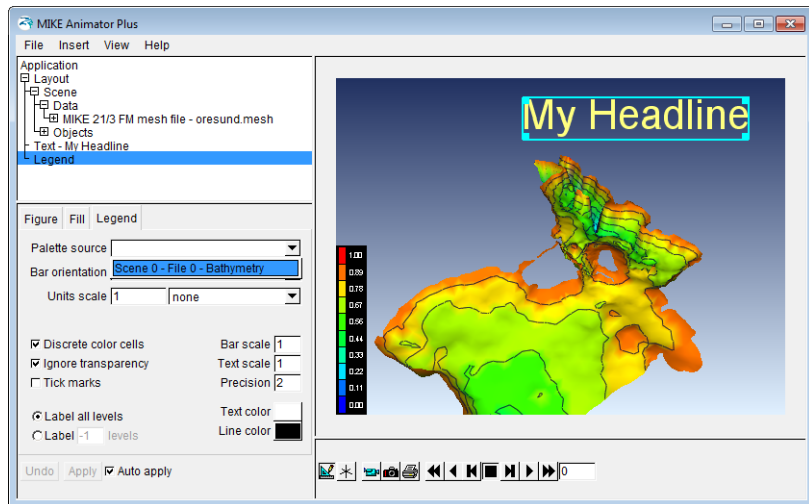

Figure 6.21 Legend property page: Select source for palette

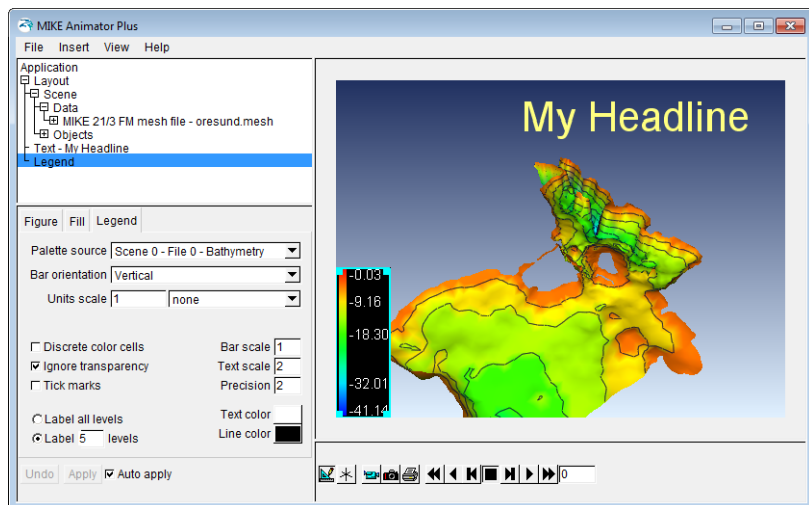

Figure 6.22 Legend property page: Modify layout of legend

6.3.3 2D Image

For presentation purpose a picture may be added to the layout.

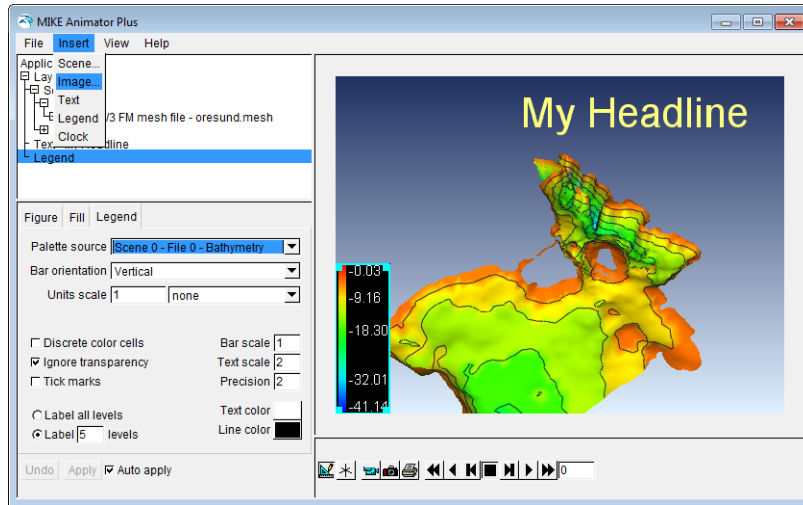

Figure 6.23 Select Insert → Image

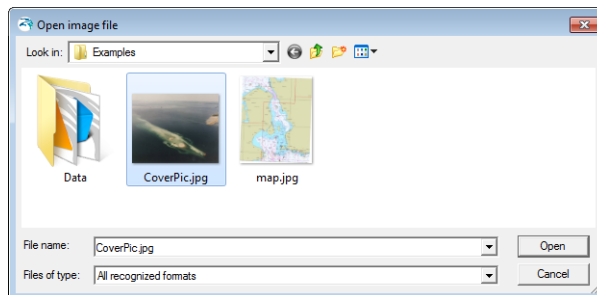

Figure 6.24 Select image file

The image may be modified with respect to transparency in the Image property page.

It is possible to position and size the image by 'dragging' the string in the display or by specifying the relative position in the Layout directly in the Figure property page.

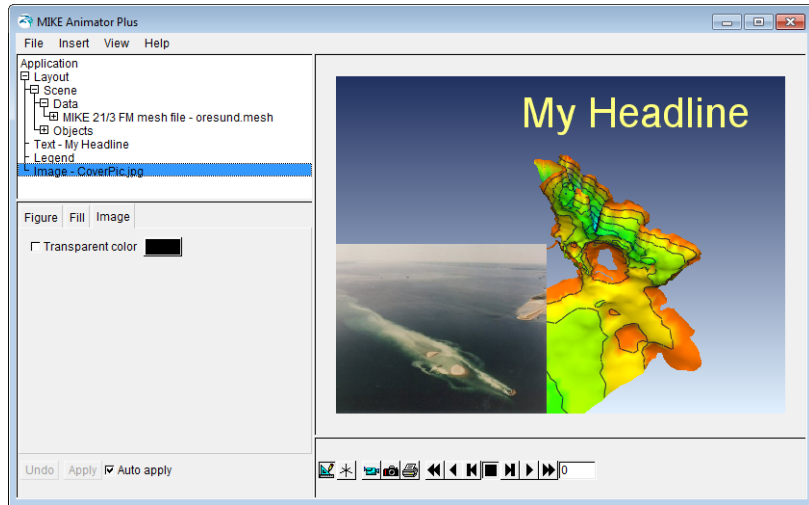

Figure 6.25 Image property page: Modify transparency

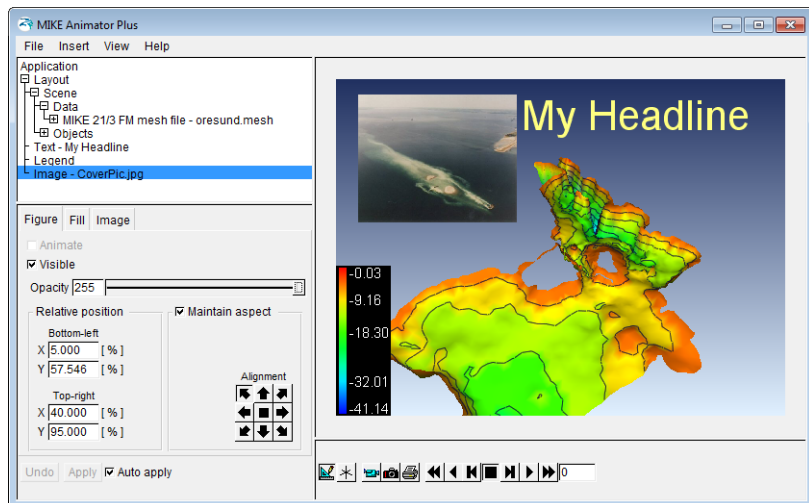

Figure 6.26 Figure property page: Modify relative position

6.4 How to drape image on surface

It is possible to drape an image on a surface. In order to drape the image correctly onto the surface the image needs to be georeferenced by a DHI world file, i.e. a file containing information about the positioning of the lower left and upper right corner of the image as well as the related map projection. In this case the image file can be termed as an 'orthoimage'.

In case no world file is shown, the image is assumed to be located in position (0,0) and can normally not be draped onto a surface.

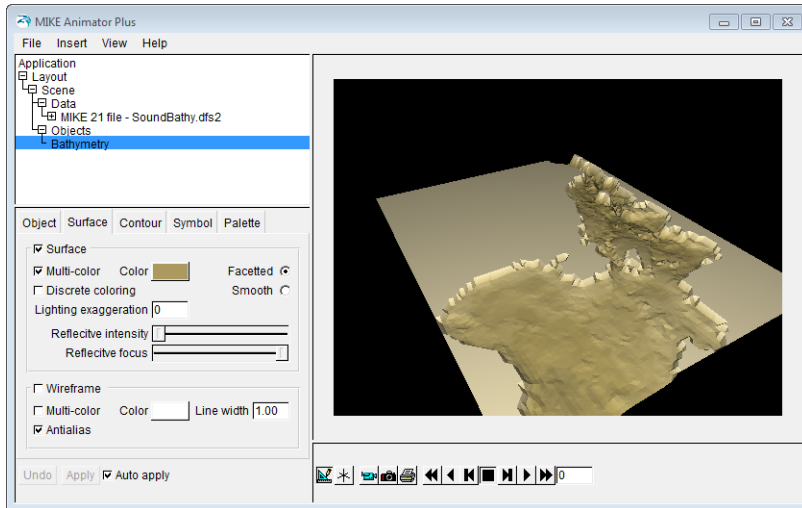

Figure 6.27 Initial setup

As the image is to be draped over an existing surface, the image must be loaded as additional data to a Scene.

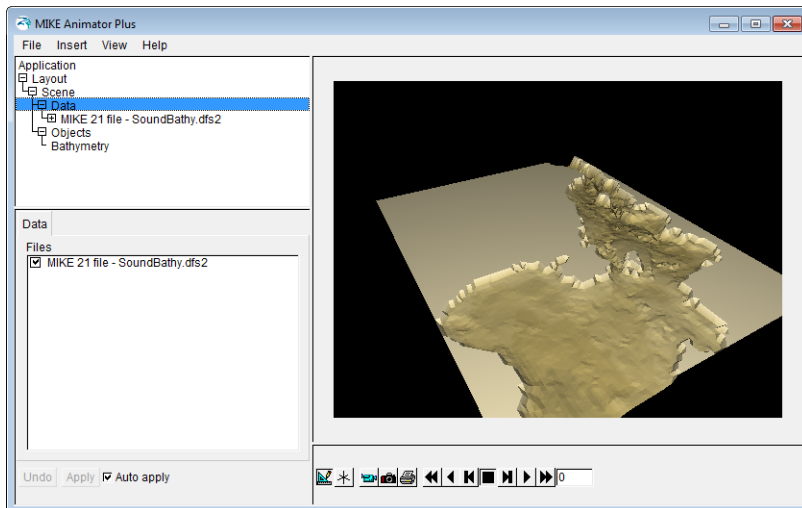

Figure 6.28 Select Data in property tree

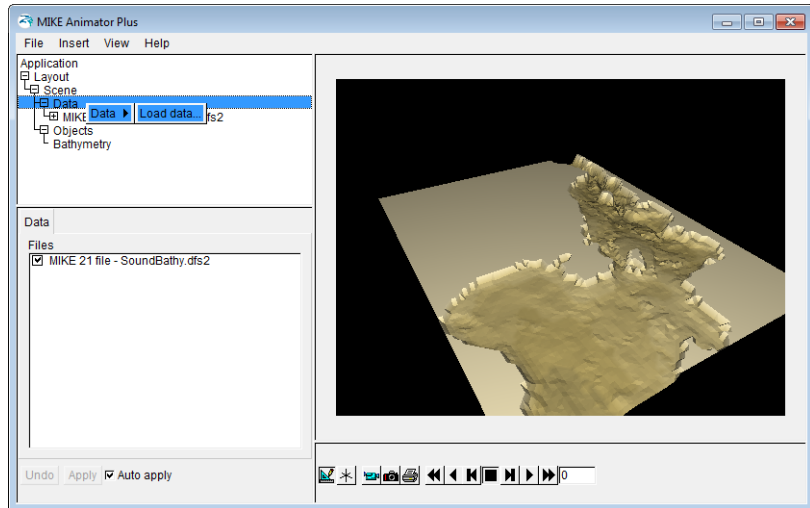

Figure 6.29 Right-click and select Load data

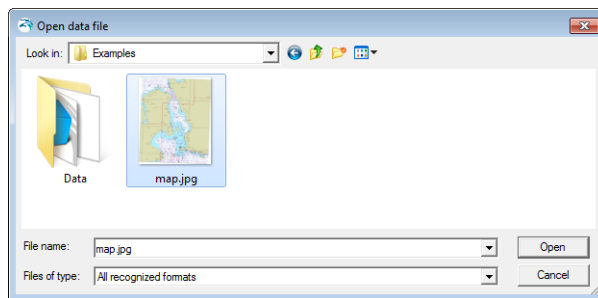

Figure 6.30 Select image file

Having selected the image file the image is contained in the Property tree however no image layer has been created yet.

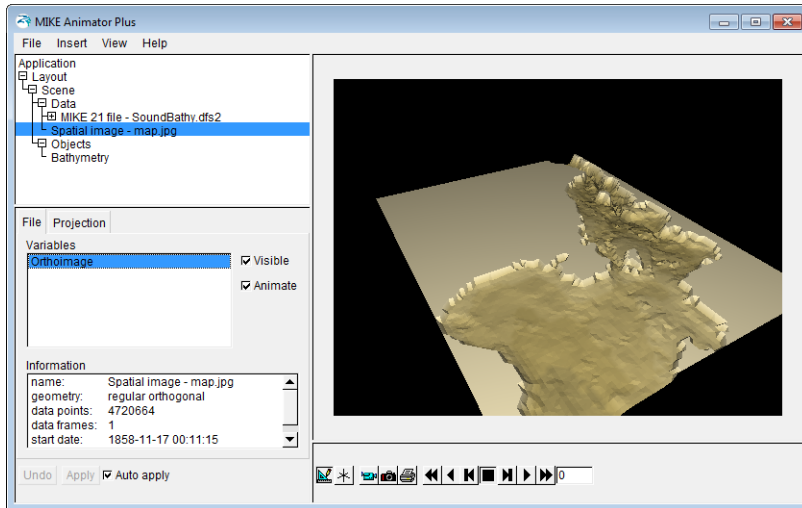

Figure 6.31 Highlight Orthoimage in File property page

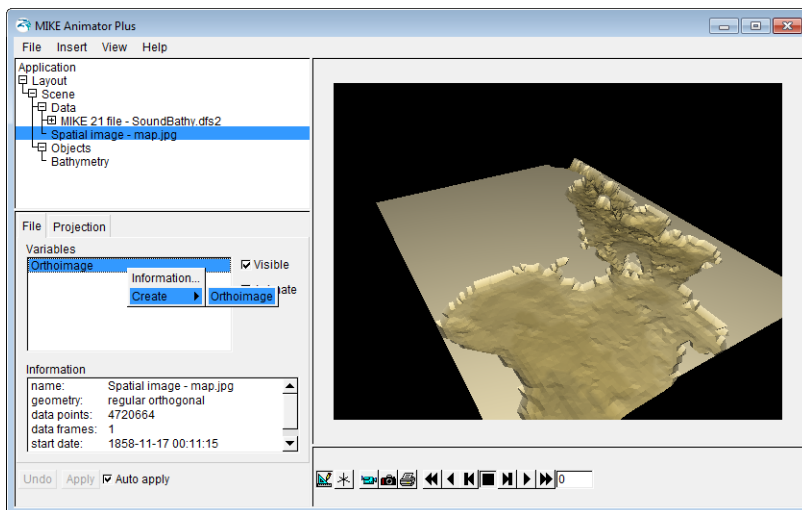

Figure 6.32 Right-click and create orthoimage layer

The orthoimage will per default be shown by the entire extension and mapped to level 0.

To drape the orthoimage to a surface select an available item shown in the drop-down menu on the Image property page.

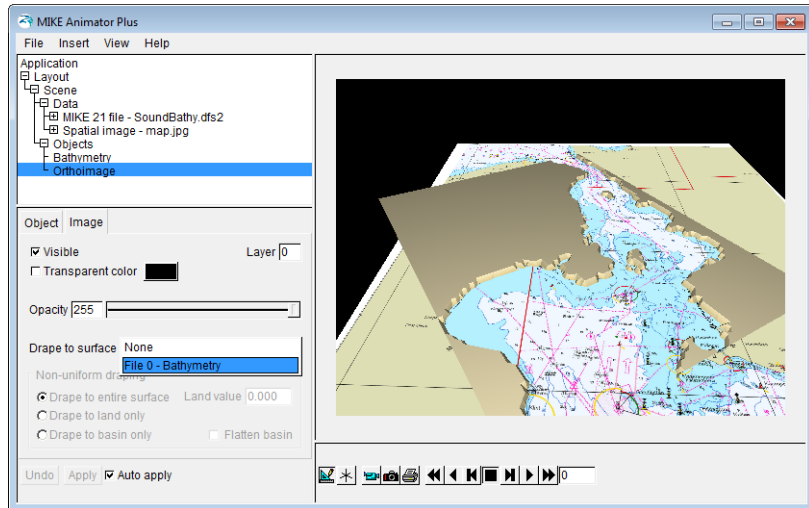

Figure 6.33 Image property dialog: Selecting surface to drape image onto

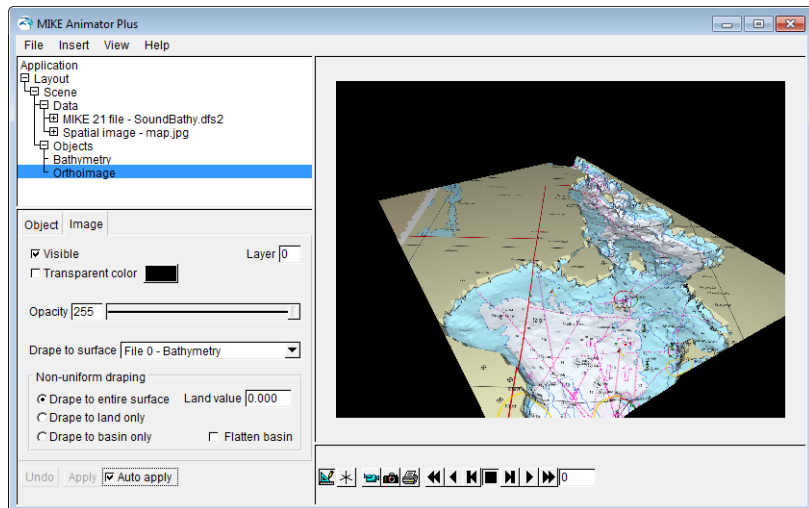

Figure 6.34 Resulting display with draped image

Note that the Image property page gives the opportunity to use non-uniform draping, e.g. so only bathymetry elements with z-values above a certain limit will be draped by the image.

6.5 How to visualise waves

MIKE Animator Plus can be used to visualise waves and wave breaking near land and coastal structures by overlaying a number of surfaces.



6.5.1 Bathymetry

First select a file and create the bathymetry layer.

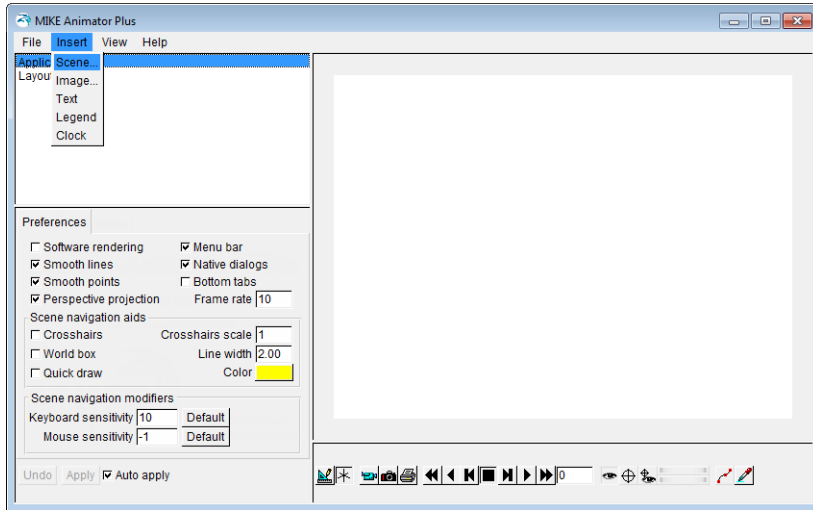

Figure 6.35 Select Insert → Scene

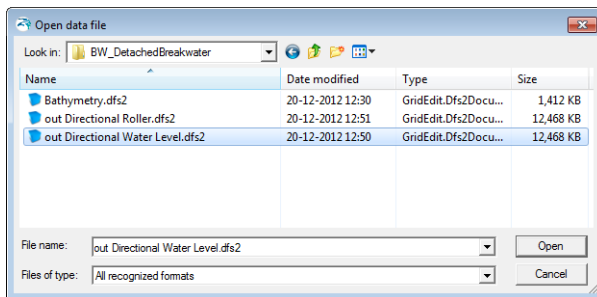

Figure 6.36 Select file to display

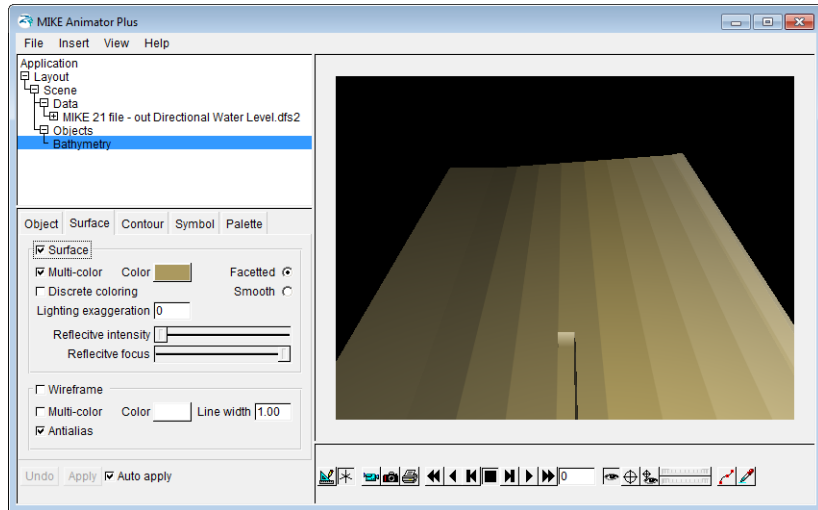

Figure 6.37 Select and create bathymetry surface

By enabling the scene mode in the graphics window in the toolbar it is possible to use the cursor to zoom and rotate the data displayed in the scene.

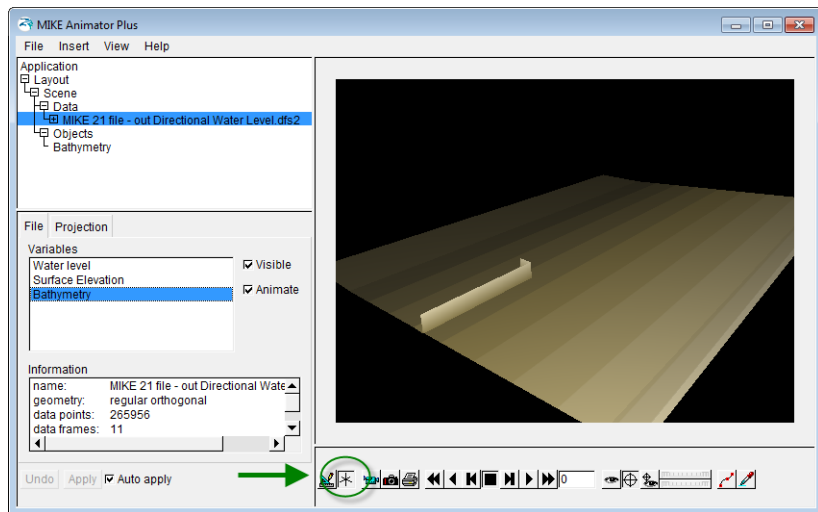

Figure 6.38 Activated scene mode: Display turned for best presentation

6.5.2 Waves

Next, highlight the item “Surface elevation” and create a surface to show in the display together with the bathymetry.

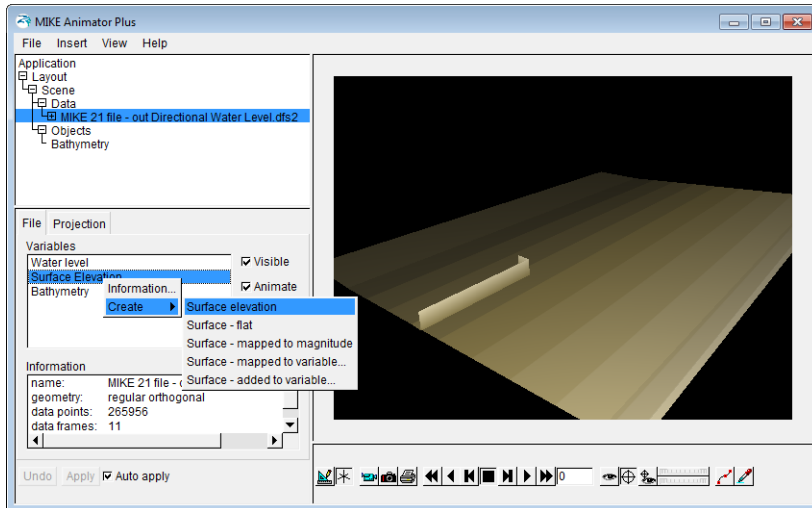

Figure 6.39 Highlight item and right-click to specify surface elevation

The surface is initially displayed by a preset multi-color palette as shown below.

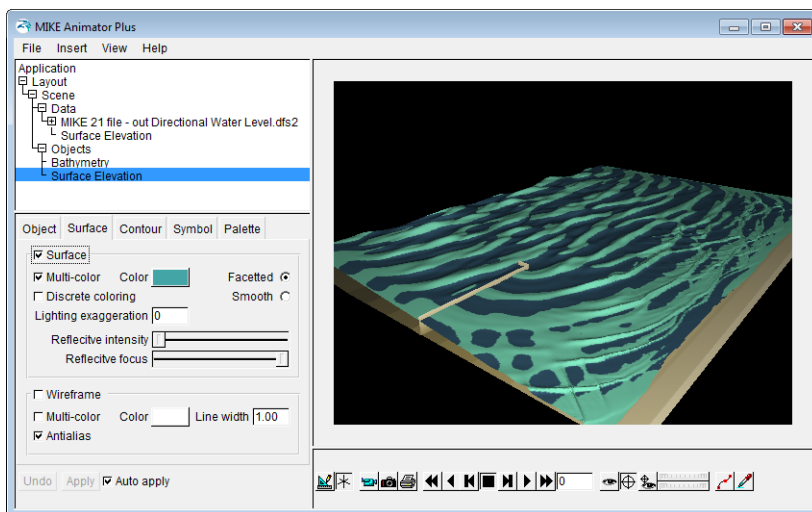

Figure 6.40 Surface property page: Modify surface properties

By modifying the surface settings on the Surface property page such that the surface is shown by one color only and with a smooth surface, such that the water surface variation is only indicated by the shadows from the light source. The light source can be modified in the Lighting property page for the scene.

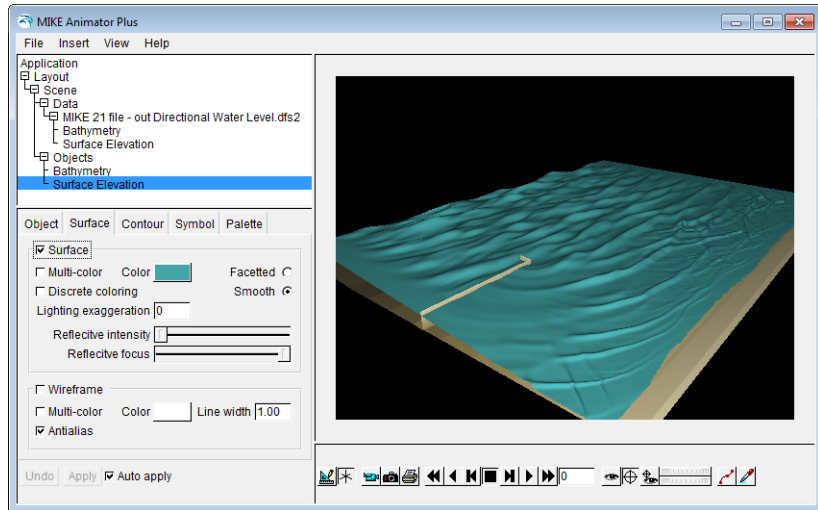

Figure 6.41 Surface property page: Resulting snapshot

6.5.3 Rollers

In order to visualise the breaking waves, a layer containing roller information is added to the scene.

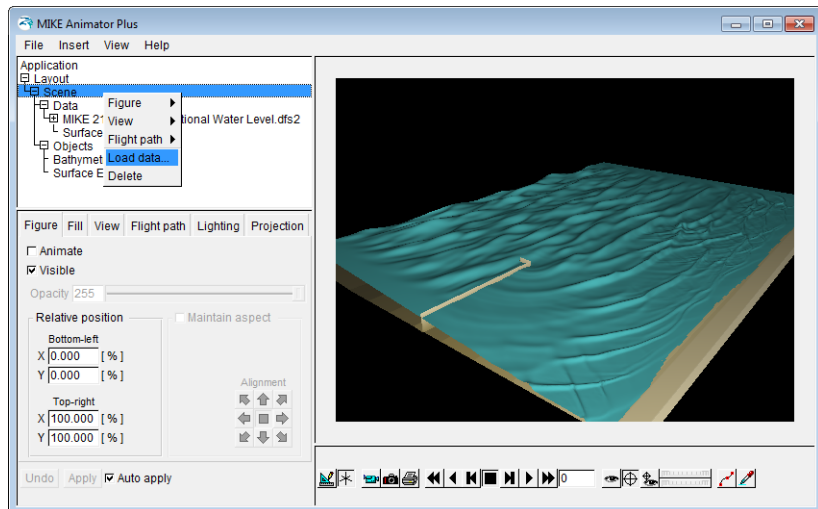

Figure 6.42 Add file to existing scene

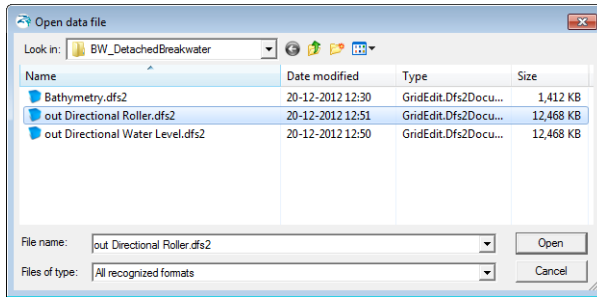

Figure 6.43 Select additional file with roller data

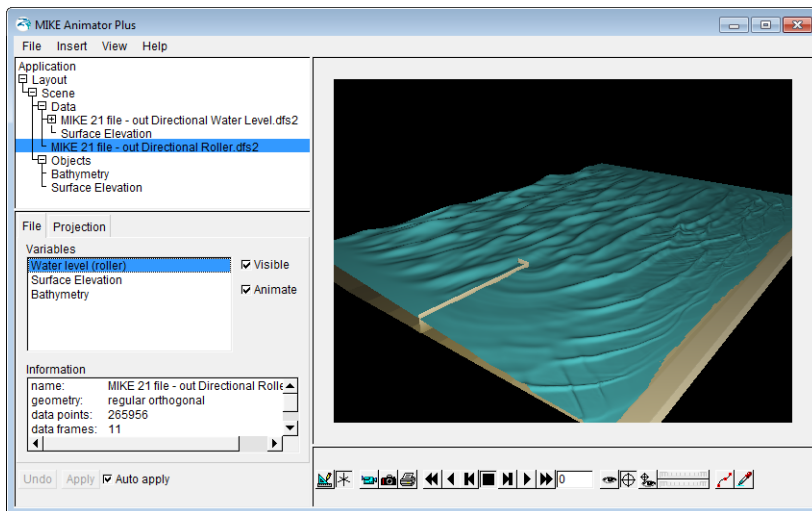

Figure 6.44 Highlight item with roller data

In order to map the roller data together with the overall water surface, the roller data layer is mapped to the surface elevation item and shown on top. As the roller data only contains values in elements with wave breaking, the underlying surface elevation layer will be visible and only overlaid in elements containing wave breaking.

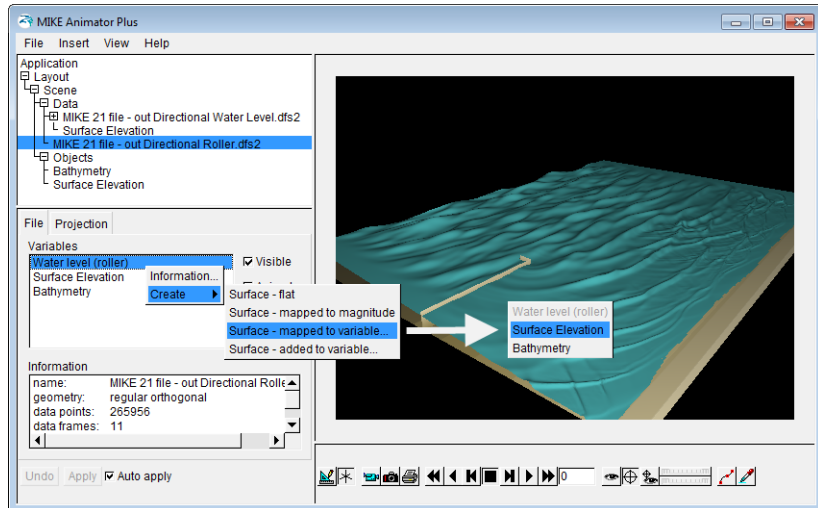

Figure 6.45 Create surface mapped to variable and select the surface to map upon

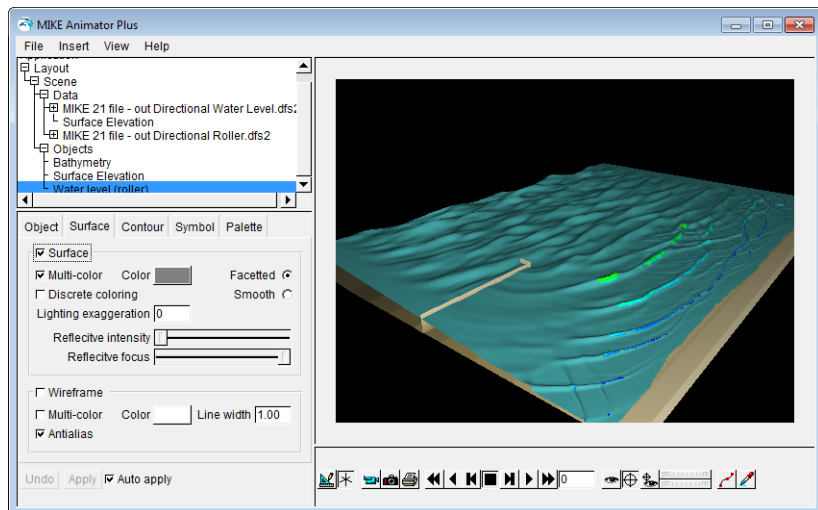

Figure 6.46 Default display of roller layer shown by rainbow palette.

By modifying the surface layer for the roller data to display the breaking waves by a smooth surface using an uniform white color the resulting image becomes very realistic.

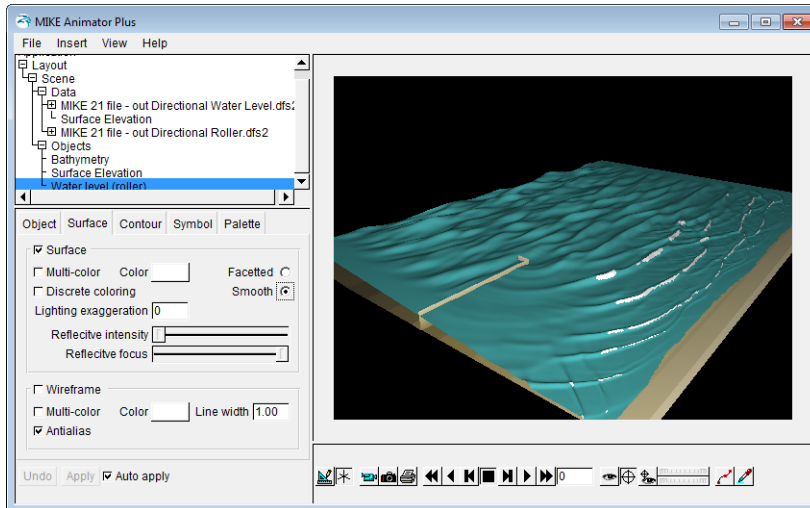

Figure 6.47 Surface property page: Rollers displayed by white color

6.6 How to animate time series data

Once you have created a MIKE Animator Plus setup using data varying in time, and the scene is enabled for animation, it is possible to animate the data by activating the toolbar.

First ensuring that the scene is enable for animation.

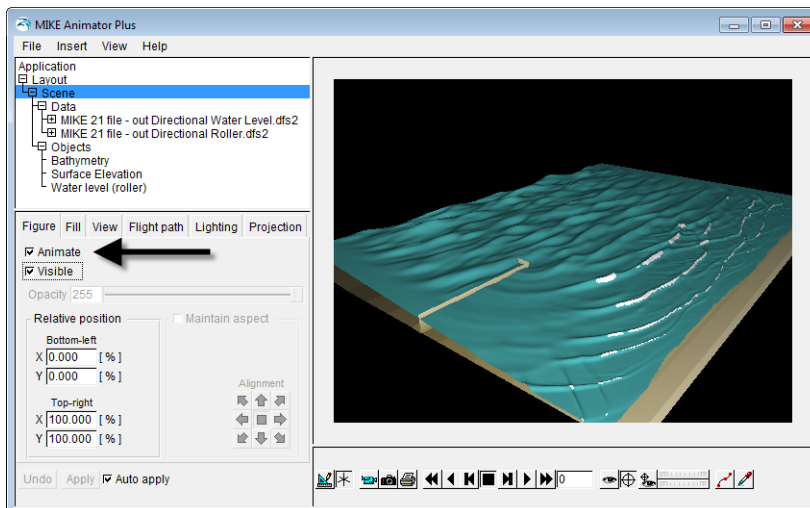

Figure 6.48 Figure property page: Scene is visible and enabled for animation

Next press the play button on the animation toolbar. This will start an animation in the graphics window of the data.

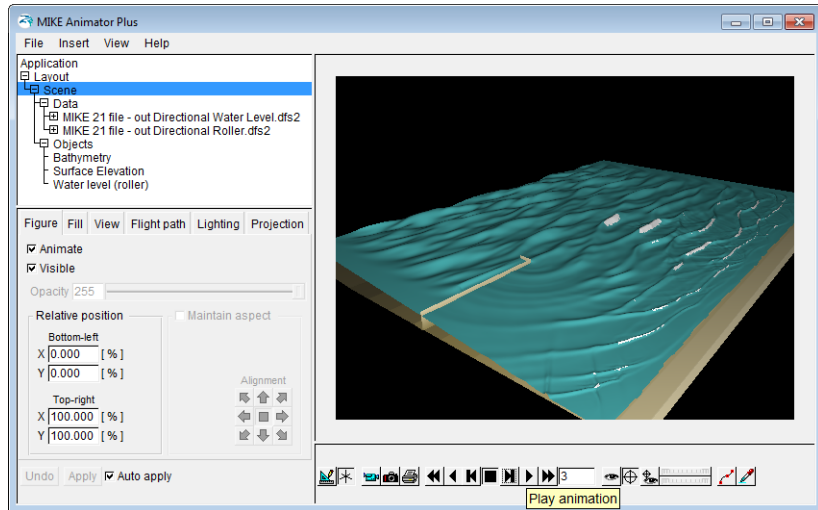

Figure 6.49 Animation toolbar: Play animation

6.6.1 Clock

In order to follow the time during animation it is recommended to add a clock to the display. First ensure that the graphic display is in Layout mode before adding a clock object. Otherwise it will not be possible to see the clock.

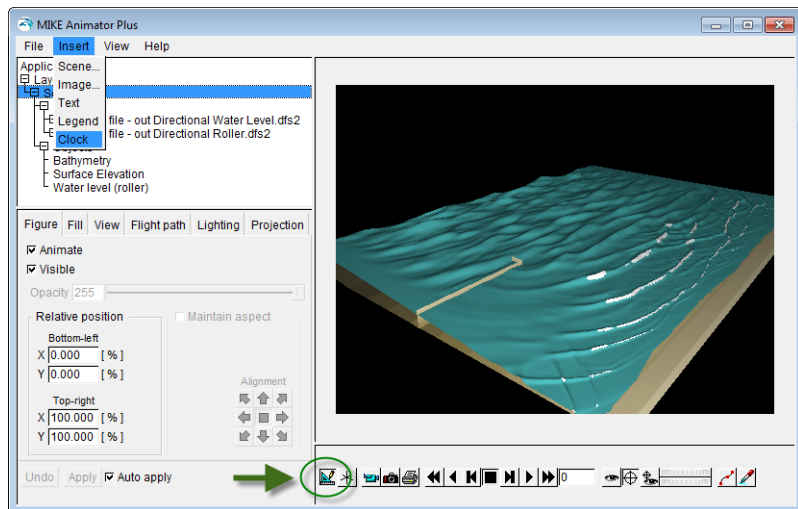

Figure 6.50 Add clock in layout mode



Per default the clock is not related to any file and thus display time 0.
Select the scene and file by which the clock is to relate.

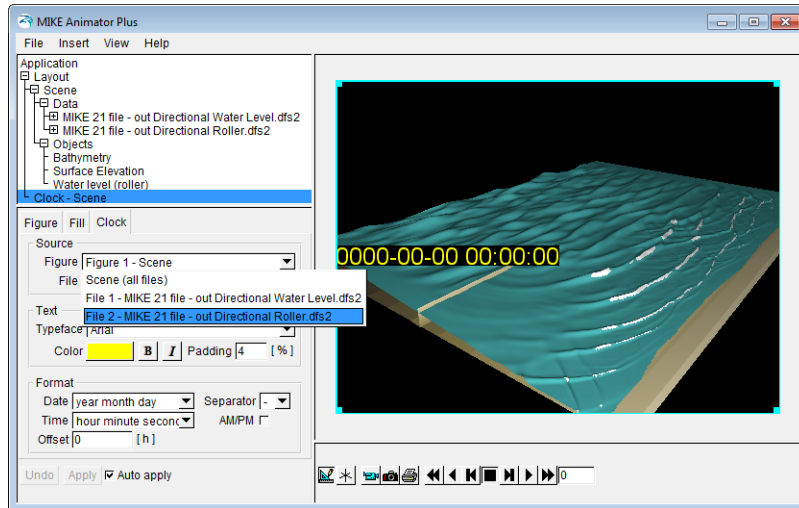

Figure 6.51 Select source for clock

Finally you can modify the clock display by the Clock property page.

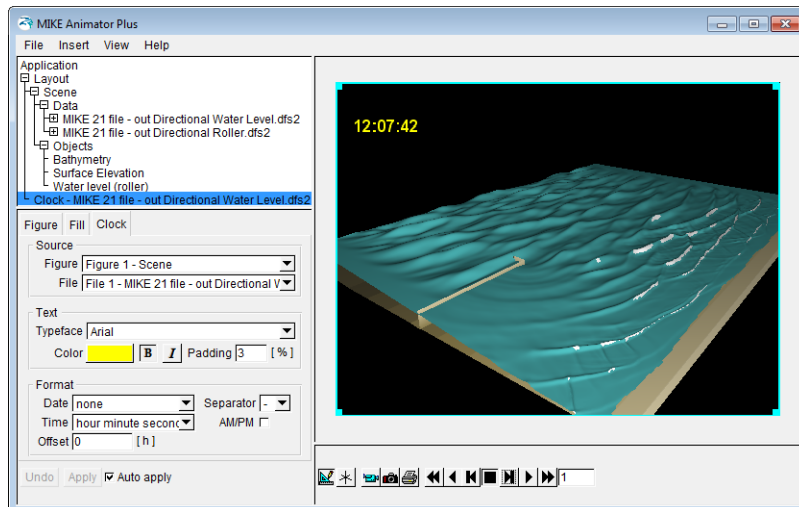

Figure 6.52 Clock property page: Modify format and position



6.7 How to record a movie

It is possible to record an animation from the graphics window in a file. First setup the overall movie properties such as Size, Format and Codec along with the selected frame rate on the Movie property page.

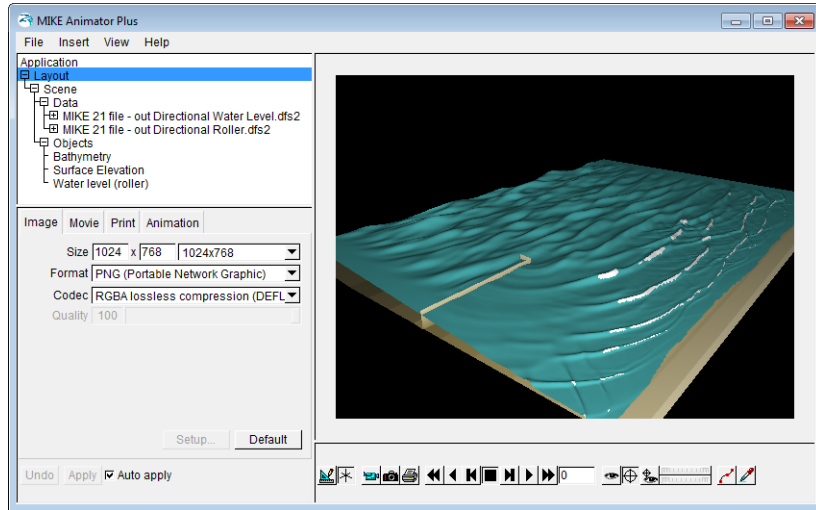

Figure 6.53 Highlight Layout in property tree

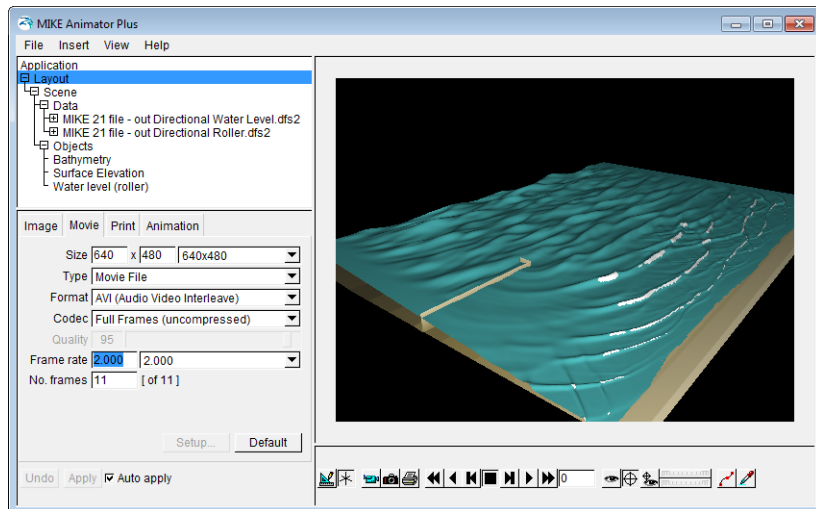

Figure 6.54 Movie property page: Modified frame rate

Next press the Record button in the toolbar to start the recording. You have to specify a filename for the video before the recording continues.

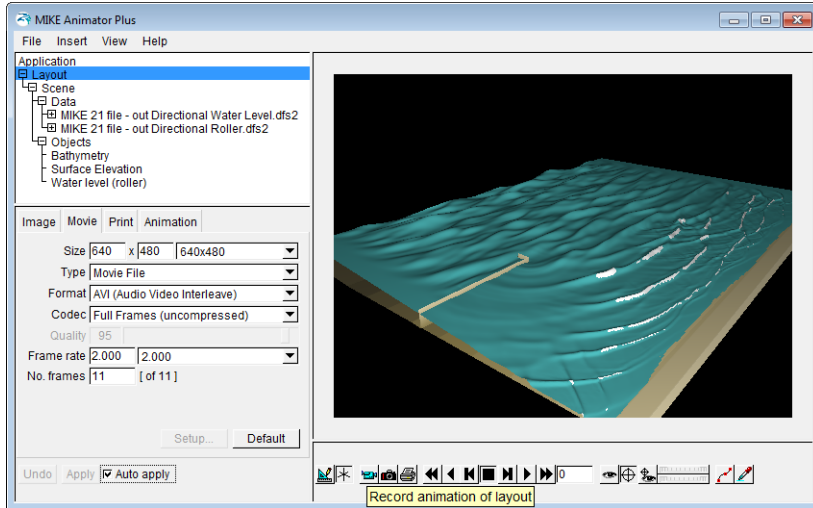

Figure 6.55 Press the video icon in the toolbar to start record video

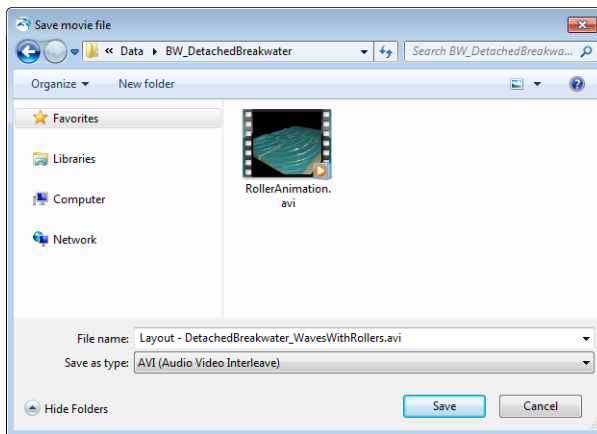

Figure 6.56 Specify the filename for the video

Note that during recording the GUI freeze. Please wait...

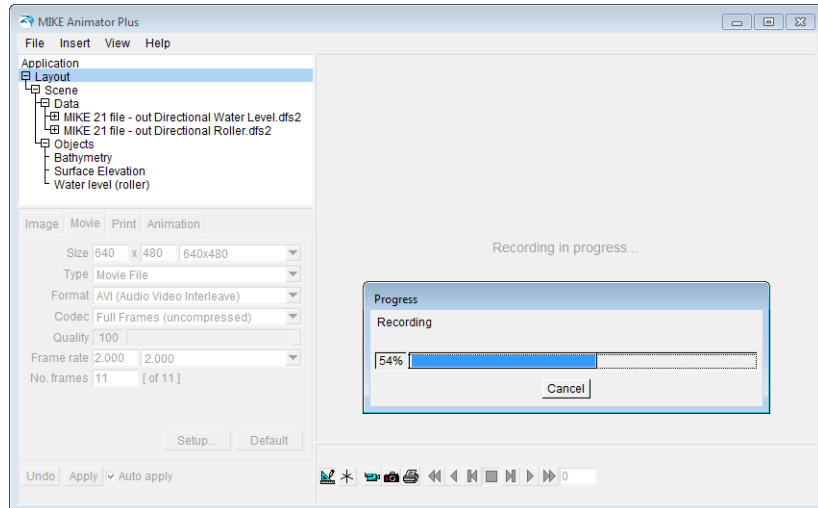

Figure 6.57 Instant snapshot during recording

The resulting file can be opened by a number of media players.

6.8 How to show flow arrows

MIKE Animator Plus can be used to visualise flux or velocity vectors if two items in the file is recognized as a pair of valid vector components. The program will then create a derived variable that may be selected for display and the surface values will automatically be shown by arrows.

6.8.1 Bathymetry

First insert a Scene, select an output dfs file with vector components and create the bathymetry layer.

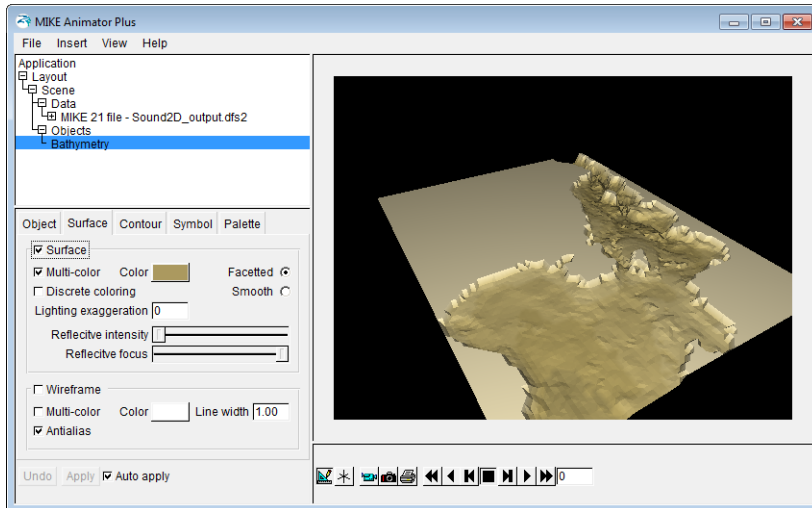

Figure 6.58 Select and create bathymetry surface

6.8.2 Current velocity

The file chosen is a standard HPQ output dfs2 file. Thus additional items can be derived internally for presentation. One of these are the item 'Current velocity'.

Highlight the 'Current velocity' item and right-click to create a Fluid Velocity layer.

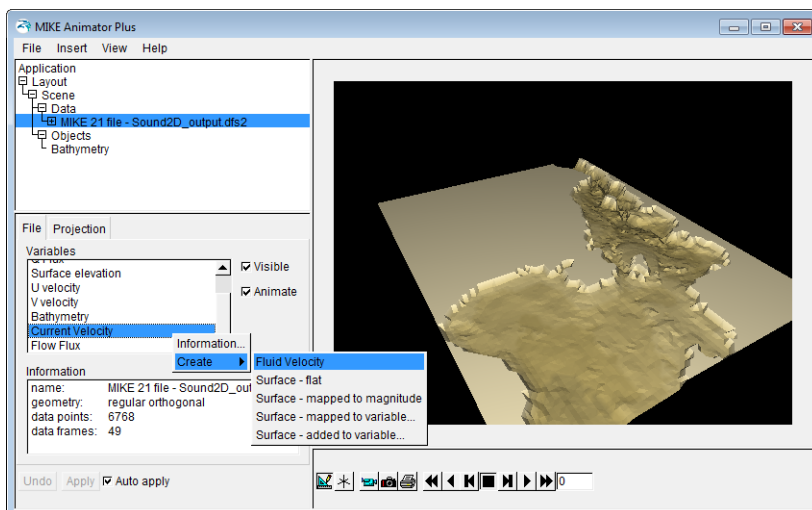

Figure 6.59 Creating fluid velocity layer

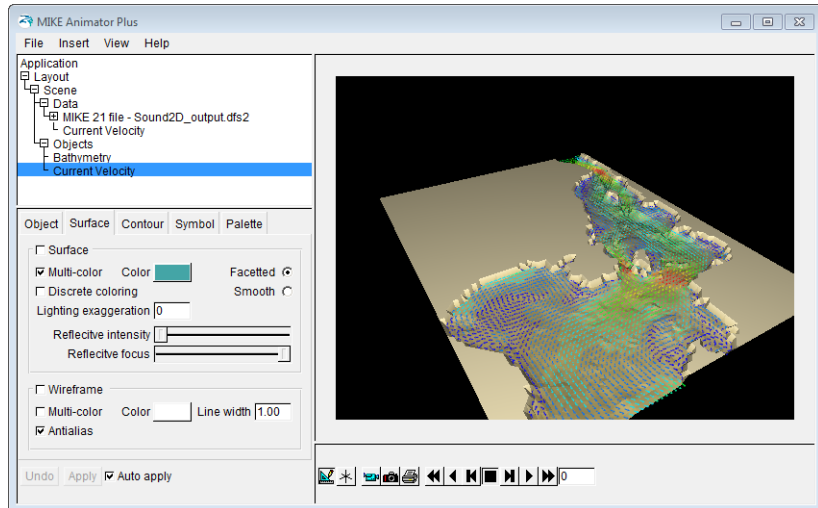

Figure 6.60 Default display of fluid velocity by vector symbols

6.8.3 Modifying symbol

The fluid velocity will automatically be displayed by equally sized vector symbols with varying color to indicate magnitude of speed.

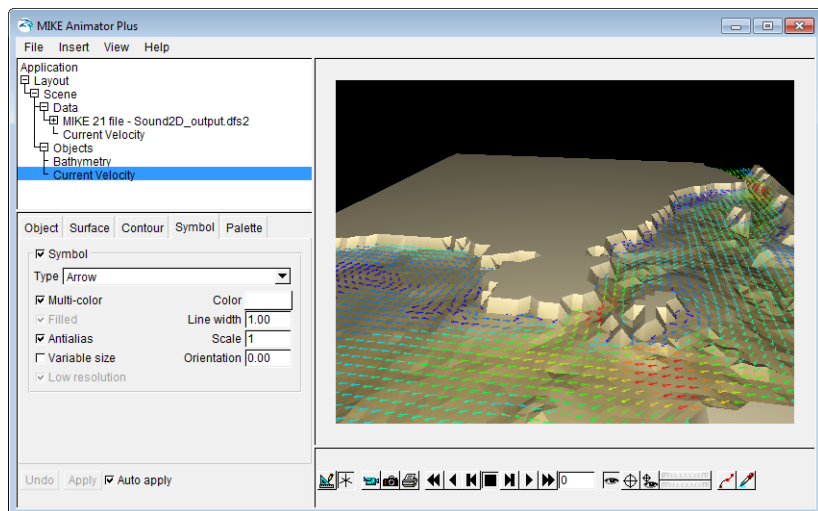

Figure 6.61 Default vector display

Often it is more illustrative to scale the vectors in size. This is possible by enabling 'Variable size' in the Symbol property page.

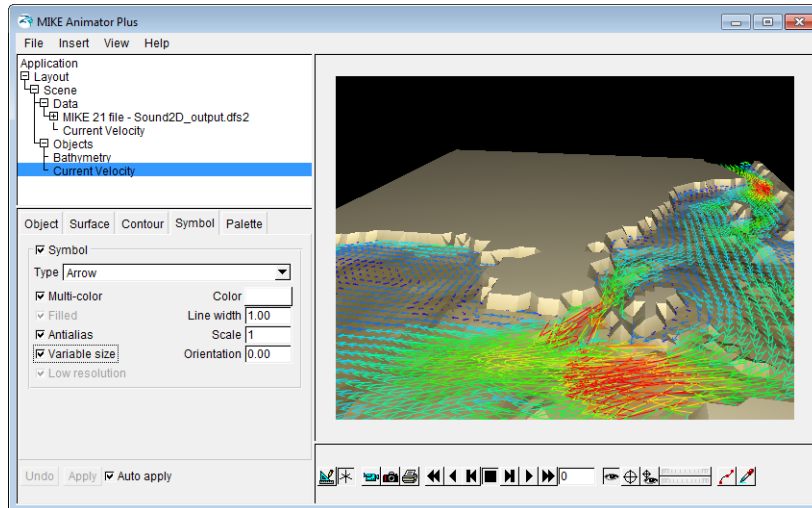

Figure 6.62 Symbol property page: Variable size enabled

It is also possible to scale the vectors by modifying the Scale factor.

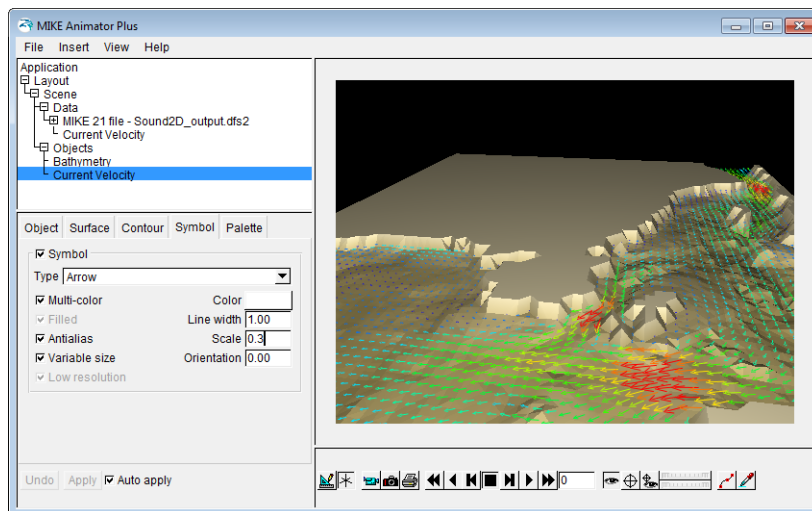

Figure 6.63 Symbol property page: Modified scale factor

6.9 How to show results from 3D dfs files

The display of data from 3D files in general follows the rules for 2D data files, only you have to specify both the item and the layer to be displayed.



6.9.1 Bathymetry

First insert a Scene and select a 3D output dfs file.

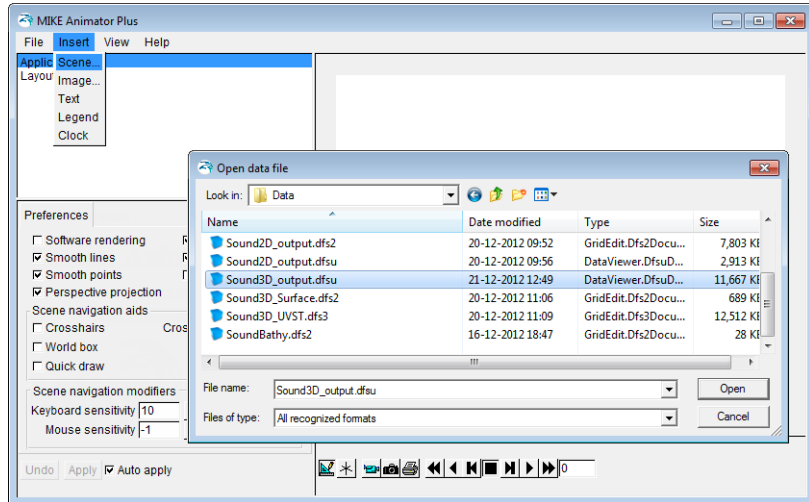

Figure 6.64 Select data file

Select the bathymetry item (derived from the static item) and create the bathymetry layer.

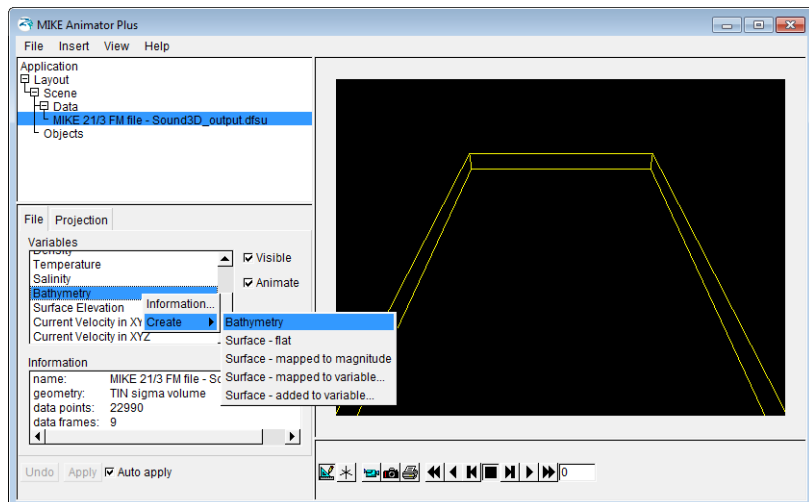

Figure 6.65 Create bathymetry layer



6.9.2 Salinity

Next select the item and layer to display.

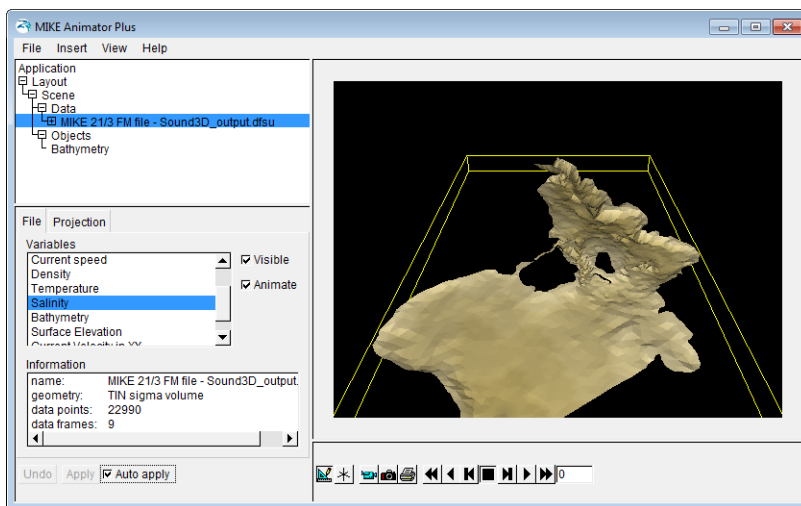

Figure 6.66 Highlight the item to display

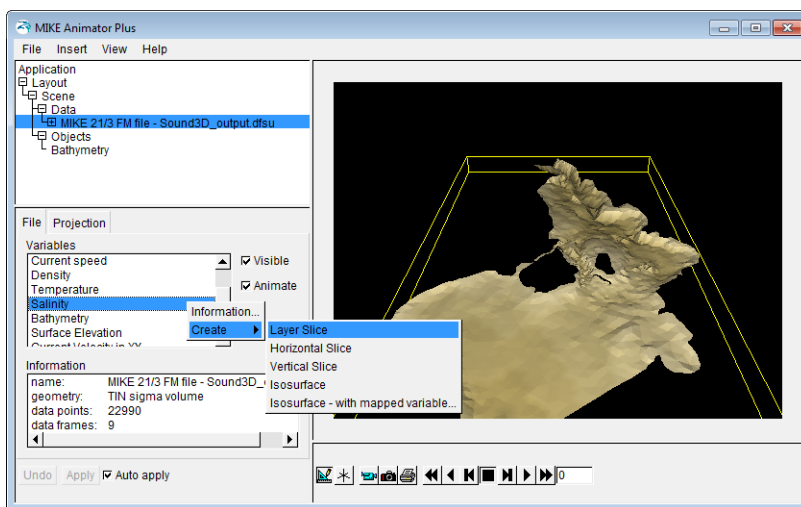

Figure 6.67 Right-click to create layer

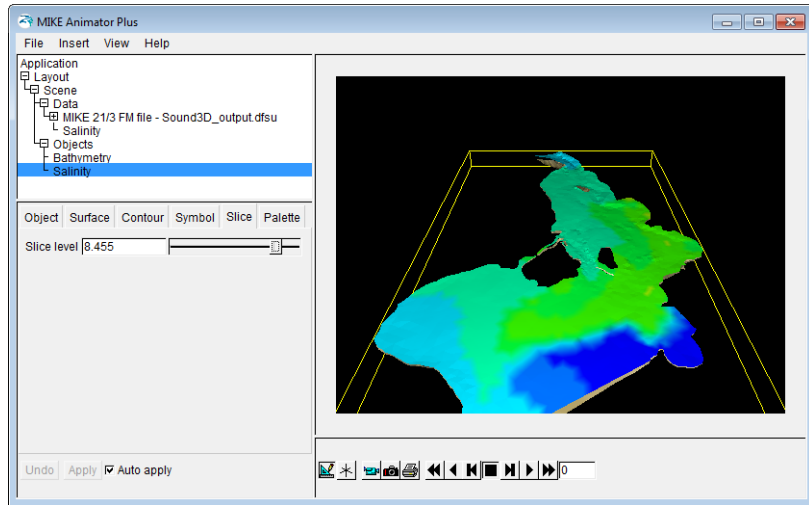

Figure 6.68 Example of layered slice

6.9.3 Type of layers

You have the option to display 3D data by 5 different types of layers:

- Layered slice
- Horizontal slice
- Vertical slice
- Isosurface
- Isosurface with mapped variable

The values in the Slice property page determines the positioning of the given slice.

Layered slice

A layered slice shows the item value for a certain level related to the layers. E.g. a slice level of 2.6 in the Slice property page will create graphics that show values interpolated using data from layer 2 and layer 3 and the surface will follow the slice level.

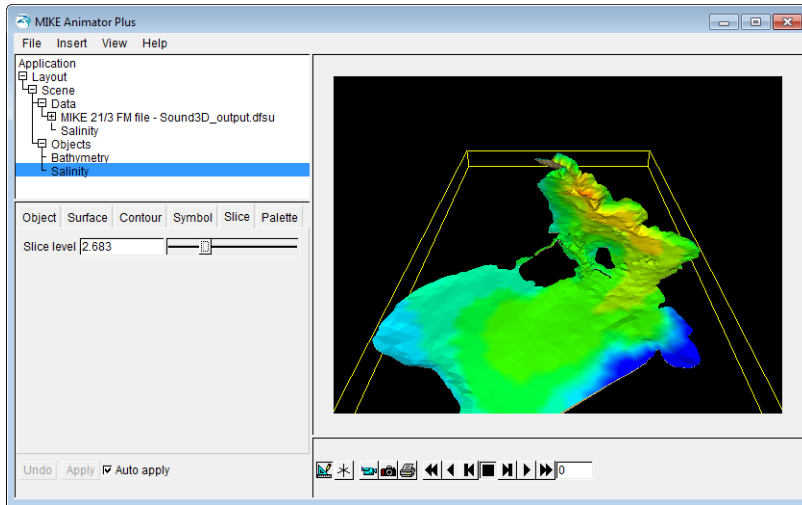

Figure 6.69 Example of salinity shown by layered slice

Horizontal slice

A horizontal slice shows the item value for a certain absolute level. E.g. a slice level of -9.4 in the Slice property page will create graphics that show interpolated values on a plane, horizontal surface. In case the level is below the sea bed no values exists.

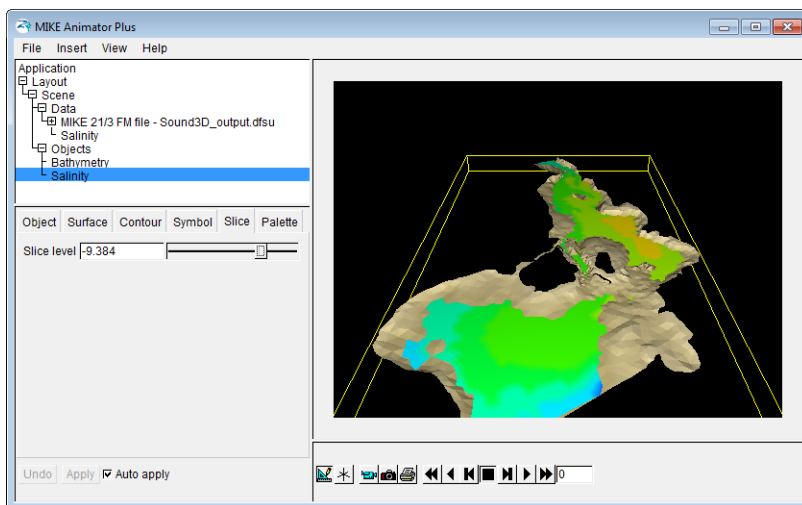

Figure 6.70 Example of salinity shown by horizontal slice



Vertical slice

A vertical slice shows the item value for a certain vertical section across the domain. You specify the position in the Slice property page by defining the direction of points A and B relative to the center of the domain.

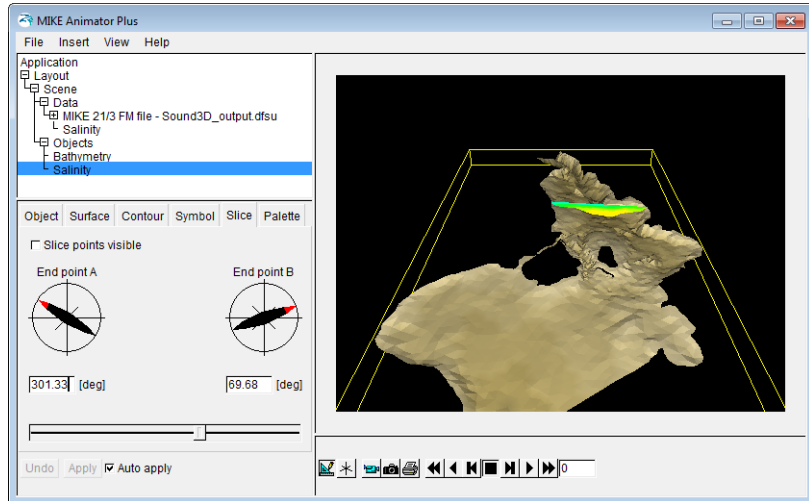

Figure 6.71 Example of salinity shown by a vertical slice

Note that a vertical slice is a surface that may be modified in similar way as other types for surfaces, e.g. it is possible to add contour lines for the individual surface using the Contour property page.

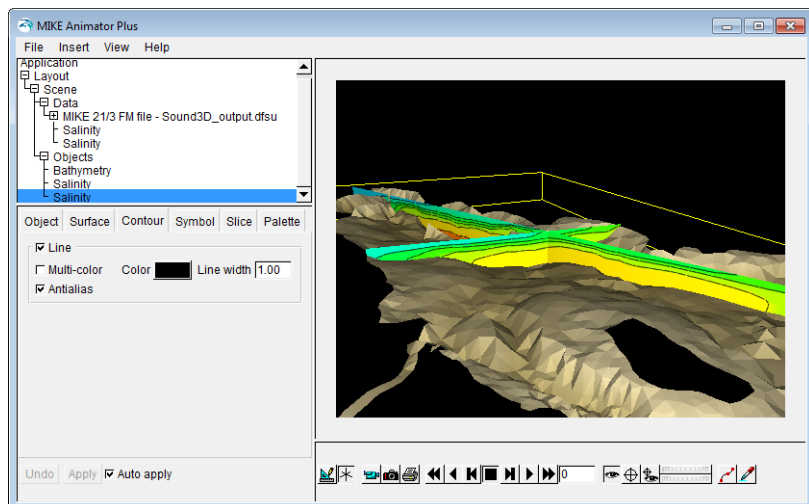

Figure 6.72 Example of salinity shown by two vertical slices with contour curves

Isosurface

An isosurface shows the surface that follows a certain value in the item data. E.g. a slice level of 28.8 in the Slice property page will create graphics that show the surface where the interpolated values becomes 28.8. In positions where the vertical data don't hold this value no data is shown.

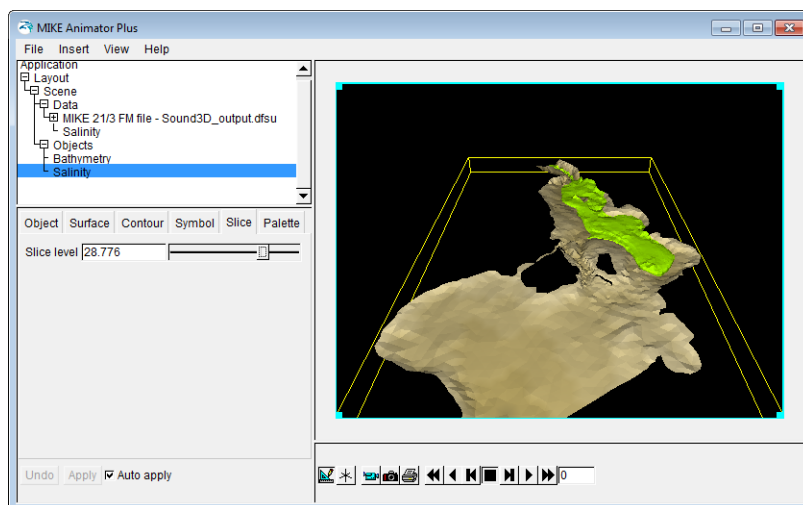

Figure 6.73 Example of salinity shown as isosurface

Isosurface with mapped variable

An isosurface with mapped variable shows the surface that follows a certain value in the item data, however the coloring of the surface will correspond to the mapped variable. E.g. salinity as an isosurface mapped to temperature will create graphics that show the surface where the interpolated values becomes the given slice level, but the color code indicates the corresponding temperature.

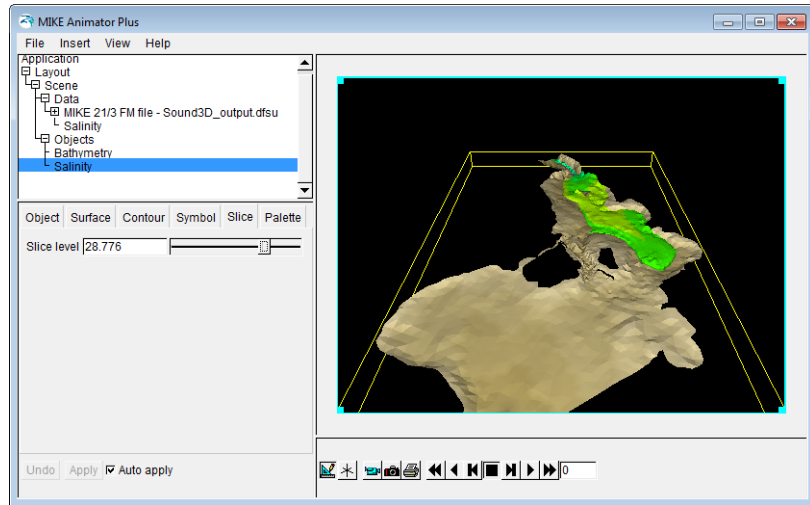

Figure 6.74 Isosurface with mapped variable

6.10 How to visualise dynamic bed level

Per default the bathymetry item is static and constant in time. However it is possible to display a dynamic item in similar way as the bathymetry. And hence visualize the effect of e.g. bank failure by overlaying a number of surfaces.

The results from a FM simulation with a varying bed level may contain the item “Still water depth”. By multiplying this item by -1 the values can be interpreted as the bathymetry level. For clarification the item description is renamed to “Dynamic bed level” and item type is changed to “Bed level”.

6.10.1 Bathymetry

First select a file to display.

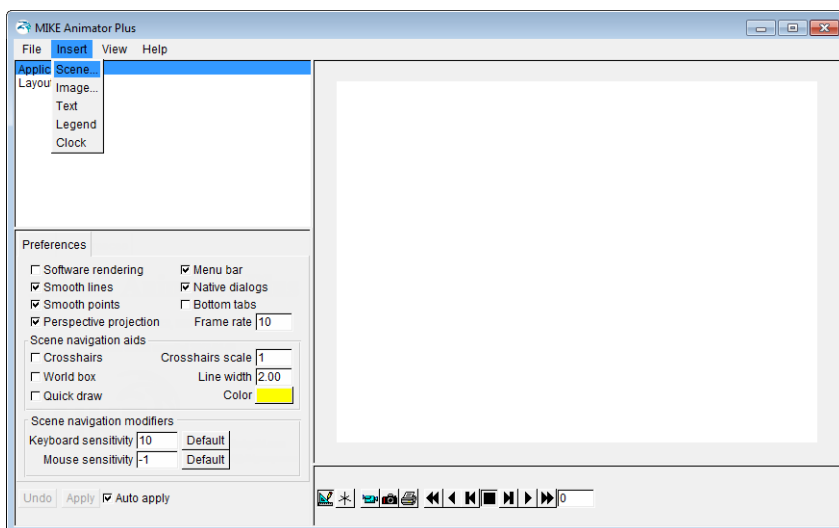

Figure 6.75 Select Insert → Scene

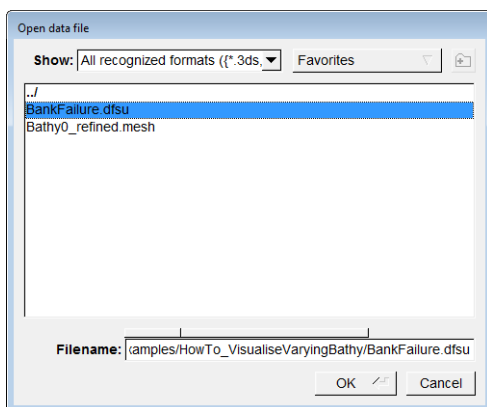

Figure 6.76 Select file to display

Next highlight the item “Dynamic bed level” and create a surface that is mapped to magnitude.

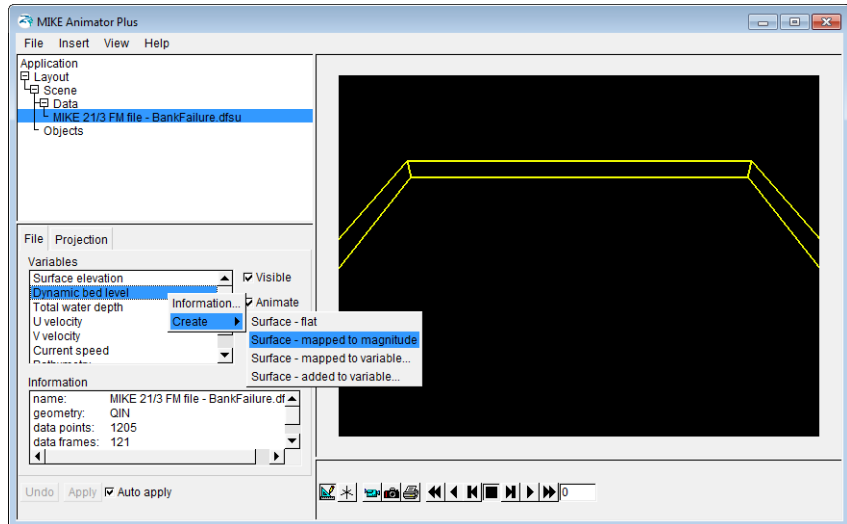

Figure 6.77 Select item and create mapped surface layer

Per default the surface layer for an ‘un-recognized’ item is displayed by the Rainbow palette. By choosing the preset “Land” palette the surface layer will resemble bathymetry.

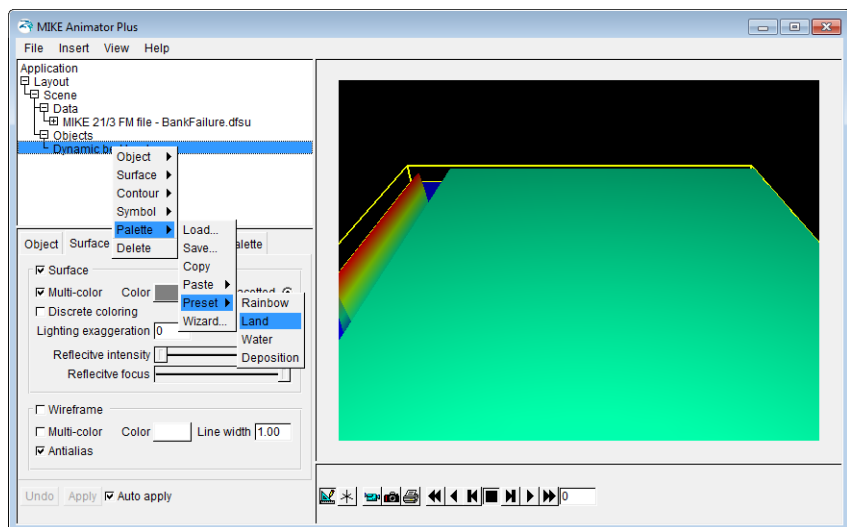

Figure 6.78 Changing color palette to resemble land

By enabling the scene mode in the graphics window in the toolbar it is possible to use the cursor to zoom and rotate the data displayed in the scene.

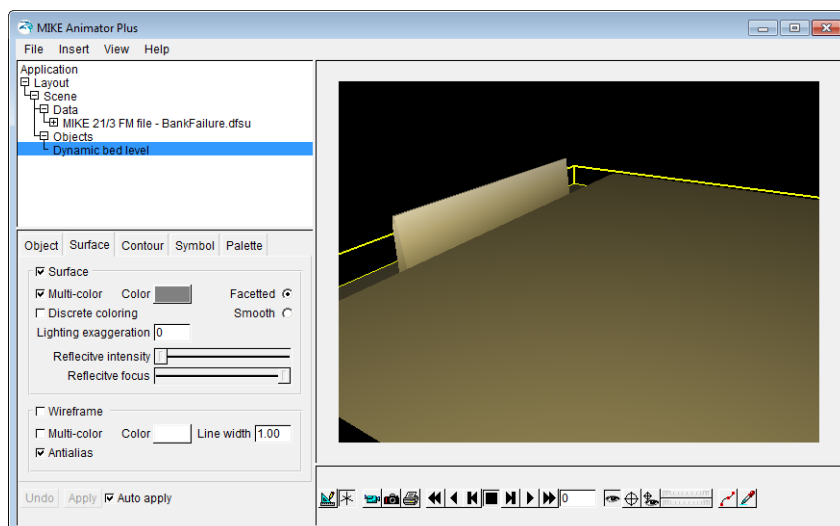

Figure 6.79 Activated scene mode: Display turned for best presentation

6.10.2 Animation

The dynamic bed level change can now be visualised by an animation in time. Add a clock to the layout for reference.
(Please see *How to animate time series data (p. 144)* for description).

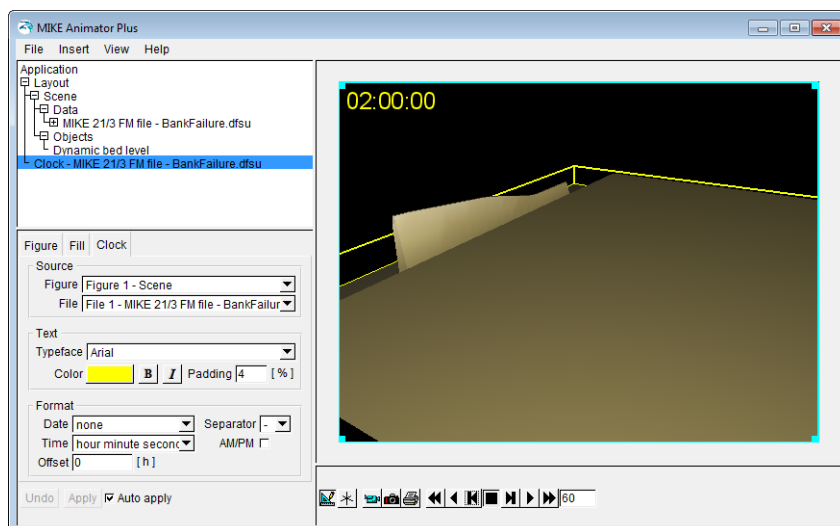

Figure 6.80 Resulting bed level change in animation



6.10.3 Surface elevation

Next, highlight the item “Surface elevation” and create a surface to show in the display together with the dynamic bed level.

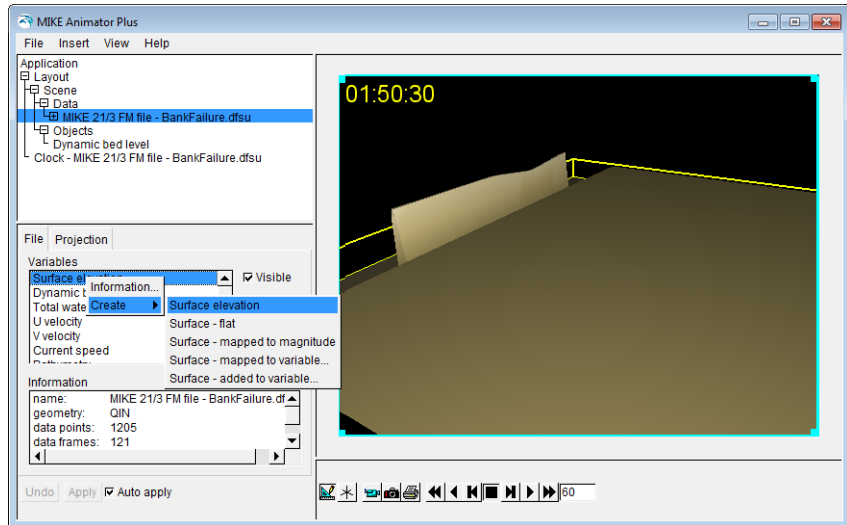

Figure 6.81 Highlight item and right-click to specify surface elevation

The surface layer item is per default shown by the preset water palette.

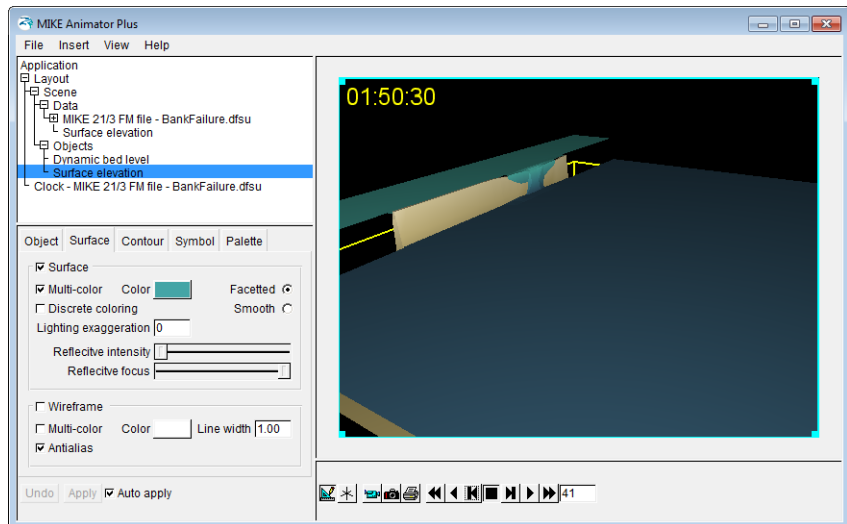

Figure 6.82 Snapshot of resulting display: start of bank failure occurrence with water overflowing the bank



6.10.4 Flow pattern

Once the surface elevation overlay the bathymetry, it is not possible to see the dynamic bed level. By disabling the surface elevation layer and adding flow vectors and a color legend it is possible to visualize the flow pattern along with the bathymetry change. (Please see How to show flow arrows (p. 149) and Legend (p. 130) for description).

Note that the color legend refers to the resulting current speed. By saving the palette it is possible to use the same for other items and setups.

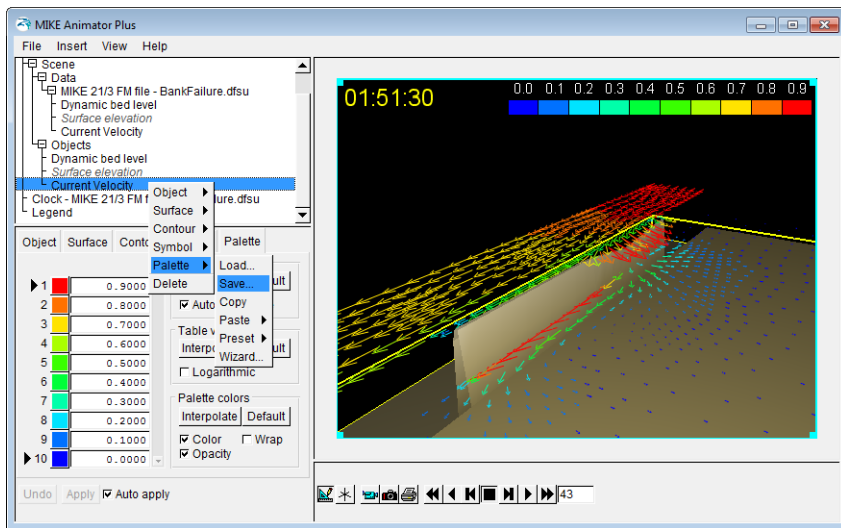

Figure 6.83 Snapshot of resulting display. Right-click the item to save palette.

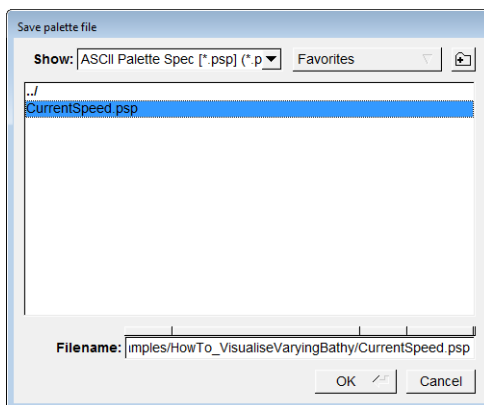

Figure 6.84 Save palette by name. Note that the format and extension of the palette file is different from the normal MIKE Zero palette file.



6.10.5 Current speed mapped to water level

It is possible to display one item by the coloring of the surface layer of another item by mapping, e.g. if you want to illustrate current speed by coloring the surface layer displaying surface elevation.

Right-click the “Current speed” item to create a surface layer mapped to variable, and next load the previously saved palette.

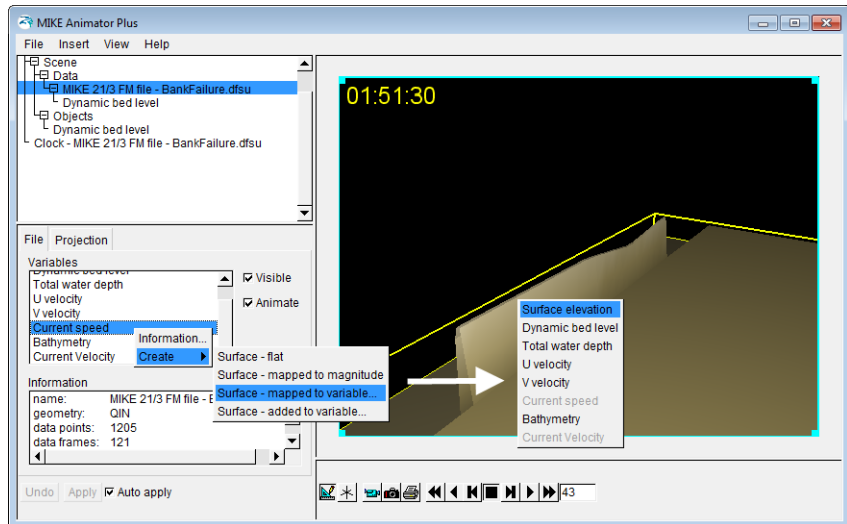

Figure 6.85 Create item mapped to variable and select the surface to map upon.

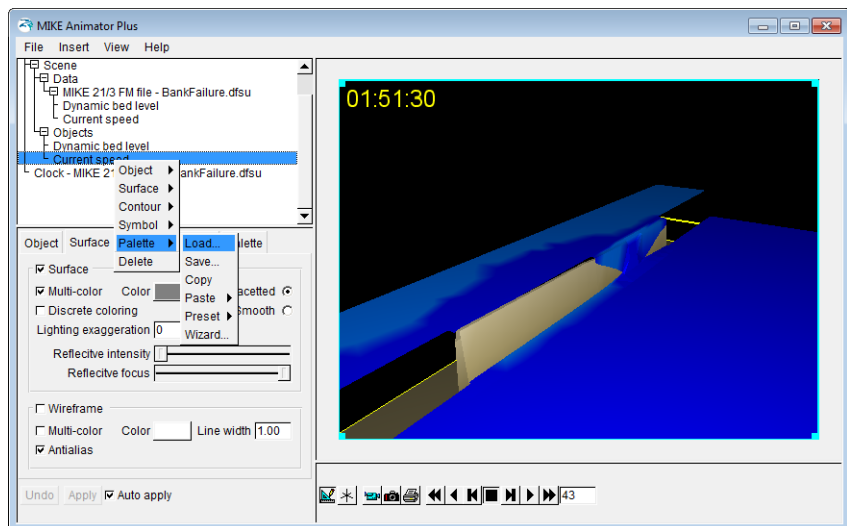

Figure 6.86 Right-click the item to load previously saved palette colors.



Note that you still have to add a Legend object in order to display the color legend in the layout.

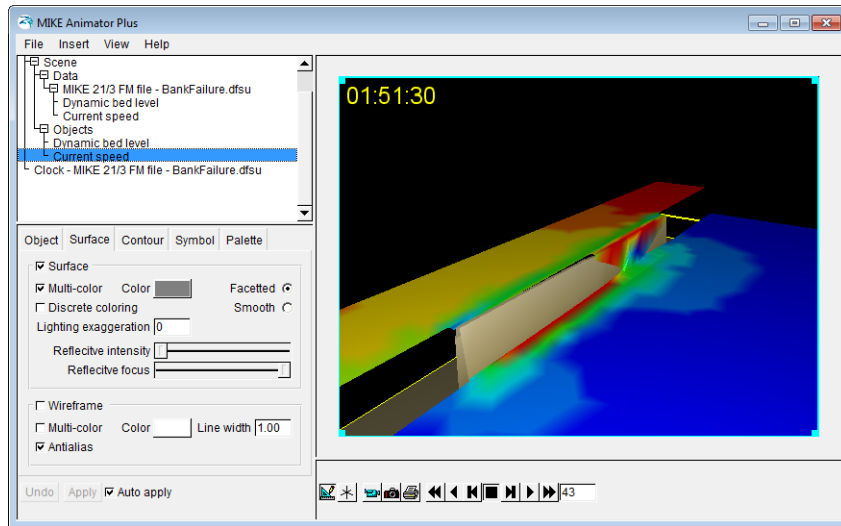

Figure 6.87 Resulting display: position of layer display actual water level whereas the colors illustrate the current speeds in the domain.

6.11 How to add and control solids

MIKE Animator Plus contains the possibility of including and visualizing 3D studio solids in a user-defined location in the domain.

A 3D studio solid can be used to e.g. visualize ship movements or a structure component such as a bridge pillar.

6.11.1 Bathymetry

First select a file and create the layer to define the domain and for reference (in this instance it is a constant bathymetry value of -10m in a domain covering 100 m x 100 m).

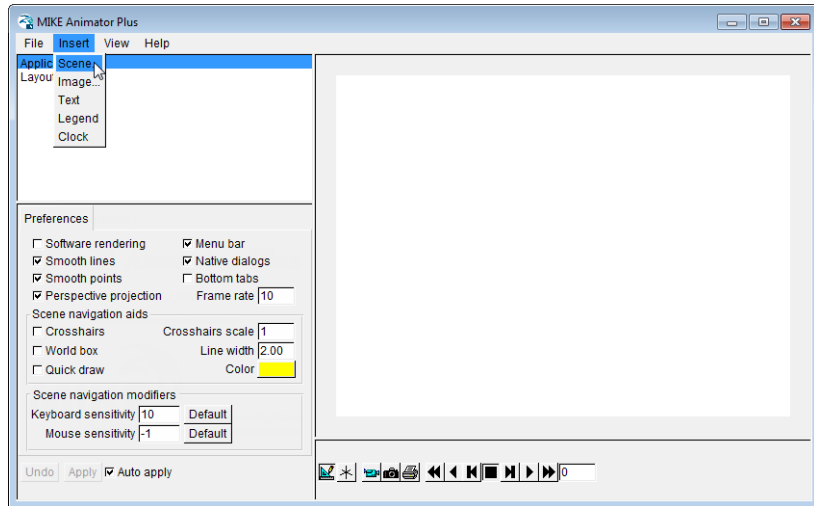

Figure 6.88 Select insert → Scene

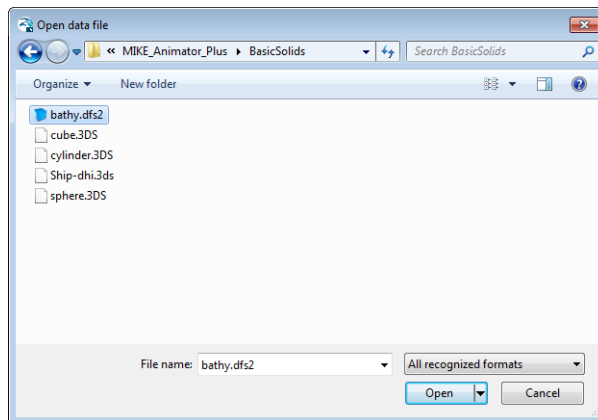

Figure 6.89 Select file to display

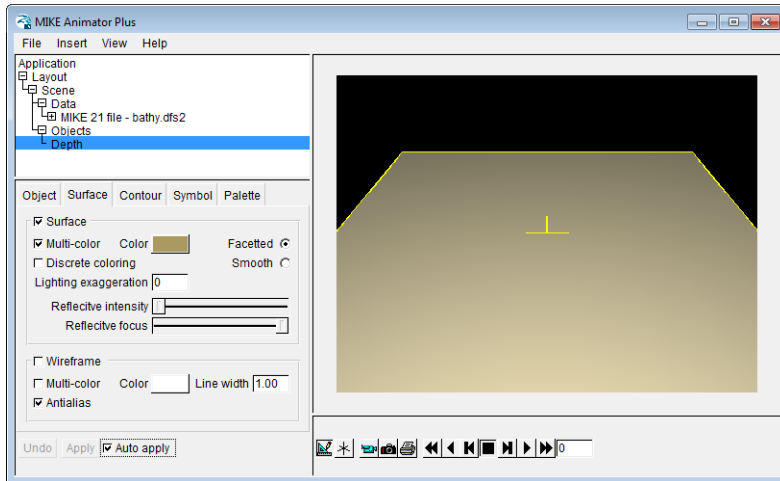

Figure 6.90 Select and create surface

6.11.2 Solid

A 3D studio is handled similar to other object components with respect to adding the solid. Select Scene to add more objects.

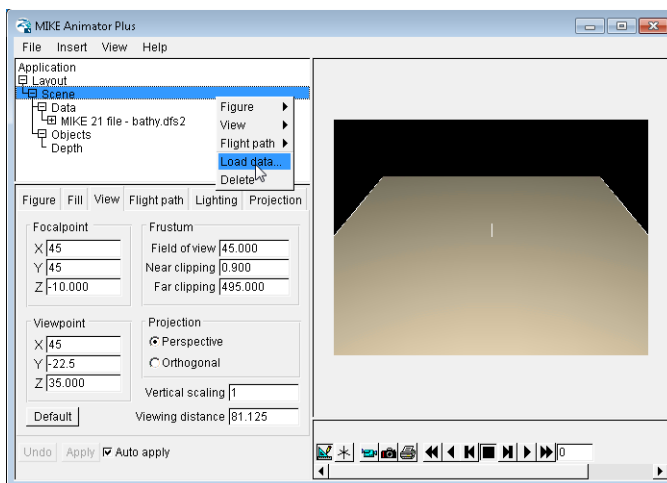

Figure 6.91 Scene and right-click to add data

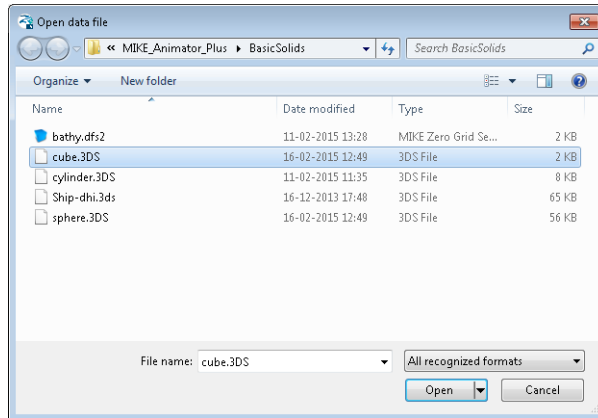

Figure 6.92 Select file to display

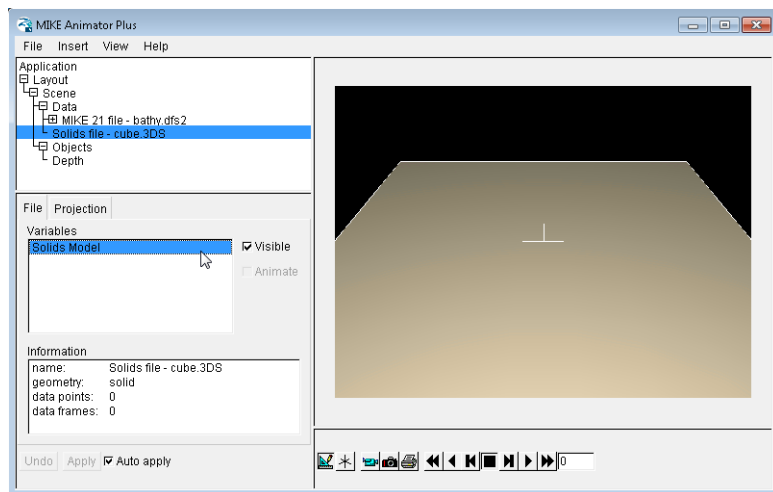

Figure 6.93 Select the variable to show the solid

The solid is initially entered into the centre of the domain, using a default size. This may result in the solid being difficult to see in the display. Often you need to place and scale the solid before a reasonable display is reached.

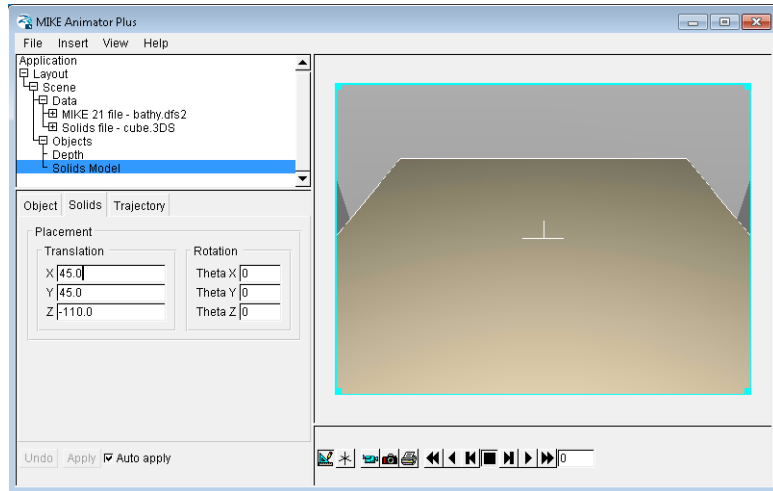

Figure 6.94 Initial display of solid

Next place the solid in position (25,25,0) and set the size of the cube sides to 10 m. If a number of solids are to be included you can rename the object to e.g. Cube for easier identification.

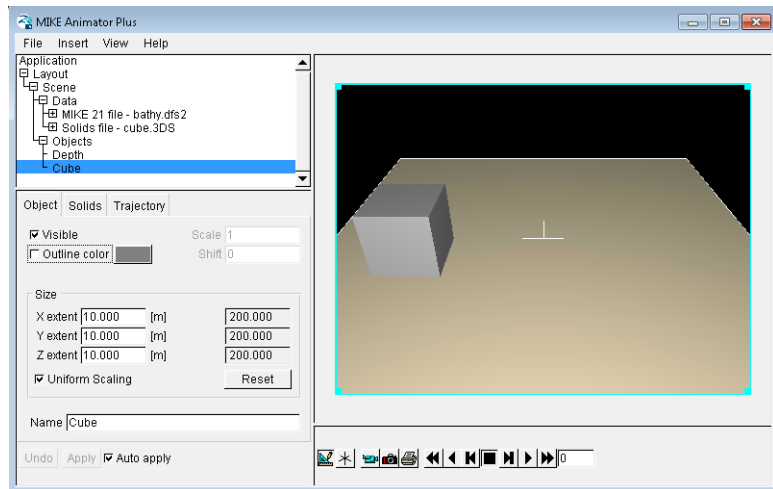

Figure 6.95 Resulting display of solid after re-positioning and re-sizing.

The installation contains other 3D studio solids such as a cylinder, a sphere and a ship. These can be included in the same scene using the same procedure as described above.

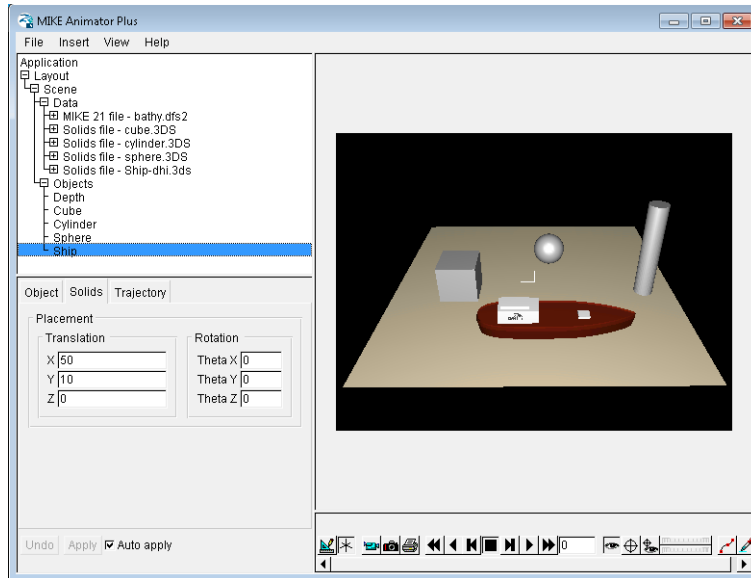

Figure 6.96 Example of solids in the display

Besides moving the solid in the horizontal and vertical direction it is also possible to rotate the solid around the three axis. This is done together with the placement of the solid. E.g. to change the orientation of the ship you can rotate the solid around the z-axis as shown in Figure 6.97. To define a moving solid you need to import a trajectory as shown in another example in the installation.

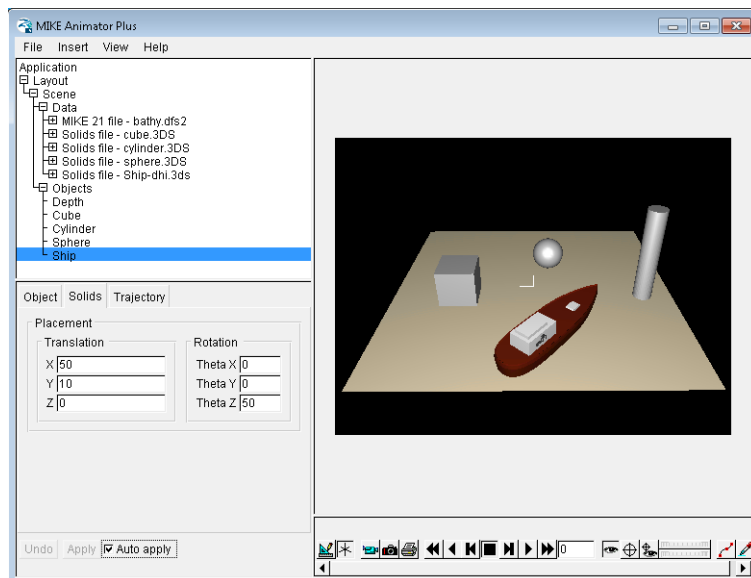

Figure 6.97 Example of rotated 3D solid



6.12 Trouble shooting

What to do if...

6.12.1 Gaps in surface

Sometimes you may experience gaps in the coloring of a surface. The occurrence of this depends on the graphics card and may be due to steep gradients in the surface (e.g. because of small grid spacings).

To overcome this problem the following can be noted:

- Using an Orthogonal projection in the View may give better results than using a Perspective projection
- If feasible, the grid spacing could be increased such that a higher accuracy can be obtained in the view (scale the vertical accordingly)
- Enabling Software rendering in the Preferences dialog sometimes resolves the issue



INDEX

**Numerics**

3D solid 48, 58

A

Animate 34

Animation 29, 144

Arrow 149

B

Background fill 124

Bounding box 48, 55

C

Clock 30, 145

Contour 31, 127

Coordinate system 77

Correction angle 64

Crosshairs 82

D

Derived item 149

DHI world file 42, 133

Draping 41, 94, 133

Drawing order 50, 53

E

Edit Unit Base Group 14

ESRI world file 43

F

Figure 33

File 34

Fill 35

Flight path 36, 39, 84

Flight speed 39

Focalpoint 27

G

GOB 47

H

Horizontal slice 56

I

Image 40, 131

Image output 43

Isosurface 158

Item type 23, 65

L

Layer 154

Layout Mode 14

Legend 44, 130

Lighting 45, 140

M

Model area 72

Model coordinates 80

Movie 46, 80, 86

O

Object type 24

Online help 9

Opacity 52

Origin of solid 59

Orthoimage 41, 133

P

Palette 51, 126, 164

Perspective 66

Preferences 53

Print 55

R

Record 147

S

Scene Mode 14

Slice 56, 155

Source file 64

Surface 60

Symbol 61, 151

Synchronization 19, 29

T

Text 62, 129

Trajectory 14, 63

Transparency 40, 52

Trouble shooting 172

U

User guide 9

V

Vertical scaling 77, 124

Vertical slice 57

Video 147



Index

View	26
Viewpoint	26

W

Waves	137
Wireframe	125
World box	128

X

XML	23, 114
---------------	---------

