

# MIKE+

## River Network Modelling

### User Guide







## PLEASE NOTE

### **COPYRIGHT**

This document refers to proprietary computer software which is protected by copyright. All rights are reserved. Copying or other reproduction of this manual or the related programs is prohibited without prior written consent of DHI A/S (hereinafter referred to as "DHI"). For details please refer to your 'DHI Software Licence Agreement'.

### **LIMITED LIABILITY**

The liability of DHI is limited as specified in your DHI Software Licence Agreement:

In no event shall DHI or its representatives (agents and suppliers) be liable for any damages whatsoever including, without limitation, special, indirect, incidental or consequential damages or damages for loss of business profits or savings, business interruption, loss of business information or other pecuniary loss arising in connection with the Agreement, e.g. out of Licensee's use of or the inability to use the Software, even if DHI has been advised of the possibility of such damages.

This limitation shall apply to claims of personal injury to the extent permitted by law. Some jurisdictions do not allow the exclusion or limitation of liability for consequential, special, indirect, incidental damages and, accordingly, some portions of these limitations may not apply.

Notwithstanding the above, DHI's total liability (whether in contract, tort, including negligence, or otherwise) under or in connection with the Agreement shall in aggregate during the term not exceed the lesser of EUR 10.000 or the fees paid by Licensee under the Agreement during the 12 months' period previous to the event giving rise to a claim.

Licensee acknowledge that the liability limitations and exclusions set out in the Agreement reflect the allocation of risk negotiated and agreed by the parties and that DHI would not enter into the Agreement without these limitations and exclusions on its liability. These limitations and exclusions will apply notwithstanding any failure of essential purpose of any limited remedy.





# CONTENTS

<b>1</b>	<b>General Settings</b>	11
1.1	Model Type	11
1.2	Description	13
<b>2</b>	<b>Map Configuration</b>	15
2.1	Coordinate System	15
2.2	Background Map	16
<b>3</b>	<b>River Network Hydraulic Modelling</b>	19
3.1	Introduction	19
3.2	Definition of a MIKE 1D Network	19
3.2.1	Digitise a River Network on the Map	20
3.2.2	Import River Network Data	21
3.3	Rivers	21
3.4	Cross Sections	34
3.4.1	Inserting Cross Sections on the Map	36
3.4.2	Cross Section Tree	37
3.4.3	Cross Section Properties	42
3.4.4	Tools and Plugins	56
3.5	Bed Roughness	80
3.6	Structures	84
3.6.1	Culverts	86
3.6.2	Weirs	95
3.6.3	Bridges	105
3.6.4	Pumps	124
3.6.5	Gates	128
3.6.6	Direct discharges	136
3.6.7	Dambreak	139
3.6.8	Energy losses	146
3.6.9	Tabulated structures	150
3.7	Storages	153
3.8	River Tools	155
3.8.1	Trace rivers from DEM tool	156
3.8.2	Compute storage from DEM tool	157
<b>4</b>	<b>Rainfall-Runoff Modelling</b>	161
4.1	Catchments	162
4.1.1	General	164
4.1.2	Description	167



4.2	Hydrological Models	169
4.2.1	Time-Area Method (A)	170
4.2.2	Kinematic Wave (B)	175
4.2.3	Linear Reservoir (C1 and C2)	178
4.2.4	Unit Hydrograph Method (UHM)	183
4.2.5	RDI	186
4.2.6	RDI - Guidelines for Application	215
4.2.7	Land uses	222
4.3	Catchment Connections	224
4.3.1	Catchment Connections Overview	224
4.3.2	Catchment Connections Editor	226
4.4	Low Impact Development (LID)	229
4.4.1	Bioretention Cells	231
4.4.2	Infiltration Trenches	232
4.4.3	Porous Pavement	233
4.4.4	Rain Barrels	234
4.4.5	Vegetative Swales	235
4.4.6	Rain Garden	235
4.4.7	Green Roof	236
4.4.8	LID Properties Editor	237
4.4.9	LID Deployment	253
<b>5</b>	<b>Modelling Stormwater Quality (SWQ)</b>	<b>259</b>
5.1	Introduction	259
5.2	SWQ Model Setup	263
5.3	SWQ Global Data	263
5.4	SWQ Methods	264
5.4.1	Identification	266
5.4.2	Surface Loads	267
5.4.3	Build-Up/Wash-Off	269
5.4.4	EMC	271
5.5	Boundary Conditions for SWQ	272
5.5.1	SWQ Boundary Condition Types	273
5.5.2	Spatial Extent	274
5.6	WQ Boundary Properties for SWQ	275
5.6.1	Boundary Condition Selector	277
5.6.2	Identification	277
5.6.3	Water Quality	278
5.6.4	Temporal Variation	278
5.7	Workflow	281
<b>6</b>	<b>Initial Conditions</b>	<b>285</b>
6.1	HD Initial Conditions	285
6.1.1	Identification	285
6.1.2	Default Values	286
6.1.3	Local Values	287
6.1.4	Hotstart Files	290
6.1.5	Description	292



6.2	AD Initial Conditions	292
6.2.1	Identification	293
6.2.2	Default Values	293
6.2.3	Local Values	293
6.2.4	Hotstart Files	296
6.2.5	Description	297
<b>7</b>	<b>Boundary Conditions</b>	<b>299</b>
7.1	Hydraulic boundary conditions	299
7.1.1	Catchment boundary conditions	299
7.1.2	Network boundary conditions	301
7.1.3	Spatial extent	304
7.1.4	Temporal variation	305
7.1.5	Limited interval	307
7.1.6	Scaling factor	307
7.1.7	Distributed weights	307
7.1.8	Q/h Relation	312
7.1.9	Description	315
7.2	Wind Scaling Factors	315
7.3	Leakage coefficients	316
7.4	Water Quality Boundary Condition Properties	316
7.4.1	Identification	317
7.4.2	Water quality	320
7.4.3	Temporal Variation	321
7.4.4	Scaling factor	322
7.4.5	Mixing	322
7.4.6	Description	322
7.5	Load Point	322
7.5.1	Geometry	323
7.5.2	Load point connection	324
7.5.3	Description	324
7.6	Repetitive Profiles	325
7.6.1	Diurnal patterns	326
7.6.2	Cyclic profiles	327
7.6.3	Profiles calendar	328
7.6.4	Special days	330
7.7	Boundary Overview	331
<b>8</b>	<b>Tables</b>	<b>333</b>
8.1	Curves and Relations	333
8.1.1	Capacity curves	336
8.1.2	Pump acceleration curve	336
8.1.3	Regulation curves $Q_{max}(H)$ and $Q_{max}(dH)$	336
8.1.4	QH relation	336
8.1.5	Valve rating curve	336
8.1.6	Time-Area curve	337
8.1.7	Removal efficiency	337
8.1.8	Curb inlet DQ and QQ relations	337



8.1.9	Capacity curve QdH & Power	338
8.1.10	Runoff pollutants	338
8.1.11	Basin geometry	339
8.1.12	Generic control rule	339
8.1.13	Control rule time series	339
8.1.14	Undefined type	340
8.2	Two-dimensional Tables	340
8.3	Materials	341
8.4	Outlet Head Loss	342
8.5	On Grade Captures	345
<b>9</b>	<b>Control Rules</b>	<b>347</b>
9.1	Controls in Urban and River Networks	347
9.2	Architecture of Real-Time Control Systems	348
9.3	MIKE+ Control vs. Real Life	350
9.4	Sensors	350
9.5	PID Parameters	354
9.5.1	Calibration of the PID Constants	355
9.6	Actions	357
9.7	Control Rules	365
9.7.1	Identification	366
9.7.2	Rules	366
9.7.3	Description	369
9.7.4	Difference between weir and weir in orifice	369
9.8	Control Rules Computations	371
<b>10</b>	<b>Water Quality</b>	<b>373</b>
10.1	Advection-Dispersion (AD)	373
10.2	Water Quality with MIKE ECO Lab	377
10.2.1	Notes on MIKE ECO Lab	378
10.2.2	MIKE ECO Lab Templates	380
10.2.3	MIKE ECO Lab State Variables	382
10.2.4	MIKE ECO Lab Forcings	384
10.2.5	MIKE ECO Lab Constants	386
10.2.6	Running MIKE ECO Lab Simulations	387
<b>11</b>	<b>Data Assimilation</b>	<b>391</b>
11.1	General parameters	391
11.1.1	Mode selection	391
11.1.2	Basic parameters	391
11.1.3	Forecast	392
11.2	Update parameters	392
11.2.1	Measurement location	393
11.2.2	Weighting function	394
11.2.3	Standard deviation	395
11.2.4	Description	397
11.3	Error forecast equations	397
11.3.1	Identification	397



11.3.2	Equation definition	397
11.3.3	Parameter definition	398
11.3.4	Estimation period	399
11.4	Standard deviation	399
11.4.1	Identification	400
11.4.2	Standard deviation definition	400
11.5	Perturbations parameters	402
11.5.1	Identification	402
11.5.2	Perturbation definition	402
<b>12</b>	<b>Calibrations</b>	<b>405</b>
12.1	Measurement Stations	405
12.1.1	Identification	407
12.1.2	Model Connection	407
12.1.3	Measurements	409
12.1.4	Description	410
12.2	Plots and Statistics	411
<b>13</b>	<b>Result Specifications</b>	<b>417</b>
13.1	Result Files	417
13.1.1	Identification	420
13.1.2	Location	424
13.1.3	Format	431
13.1.4	Items	433
13.1.5	DEM input	447
13.1.6	Combining various result items in one file	448
13.2	Network Summary	450
<b>14</b>	<b>Scenarios</b>	<b>455</b>
14.1	What are Scenarios	455
14.2	Design of the MIKE+ Scenario Manager	456
14.3	Managing Scenarios and Alternatives	459
14.4	How to Start Working with Scenarios	462
<b>15</b>	<b>Simulation Specifications</b>	<b>463</b>
15.1	Simulation Setup	463
15.1.1	General	468
15.1.2	Catchments	472
15.1.3	HD	475
15.1.4	AD and WQ	479
15.1.5	LTS	481
15.1.6	Results	482
15.2	Batch Simulation	485
<b>Index</b>		<b>489</b>







# 1 General Settings

MIKE+ is a flexible system for modelling and design not only of water distribution and wastewater and stormwater collection systems, but also of 2D overland domains and river networks.

The Rivers module in MIKE+ allows for:

- Modelling of river hydraulics and water quality
- Coupling to an external MIKE HYDRO river model from within MIKE+

River modelling options are made available in MIKE+ under the umbrella of 'Rivers, collection system and overland flows' model type.

Access the Model type and Description editors for River modelling under the General Settings section.

## 1.1 Model Type

The 'Model type' editor provides an 'at a glance' view of which MIKE+ features and modules are active. Active features and modules control the menus being accessible from the Setup tree view.

Within the "Rivers, collection system and overland flows" working mode, you can choose to have the following features activated:

- Catchments
- Collection system network
- River network
- 2D overland

Catchments can be connected to both Collection system and River networks. Collection system and River networks can also be connected together. When 2D overland is enabled with Collection system network and/or river network, couplings between the various features are enabled automatically.

You can then activate the following modules, which will apply to all selected features whenever relevant:

- **Rainfall Runoff (RR):** The RR module simulates hydrological processes on catchments. Enabling the Catchments feature but without including the RR module allows applying catchment discharge to the collection system and river networks.



- Hydrodynamic (HD): The HD module simulates the flows in collection system networks, river networks and/or 2D overland, depending on the selected features. The HD module includes the two sub-modules Control Rules (only apply applicable to Collection system and River networks) and Long Term Statistics (LTS), only applicable to the Collection system network.
- Transport (AD, SWQ): The transport module simulates the Advection-Dispersion processes (for e.g. pollution transport) in collection system networks, river networks and/or 2D overland, depending on the selected features. The transport option also enables stormwater quality (SWQ) simulations on catchments, when Catchment feature and Rainfall-Runoff module are active.
- Water quality (MIKE ECO Lab): The MIKE ECO Lab module simulates the advanced water quality processes (e.g. biological processes) in collection system networks, river networks and/or 2D overland, depending on the selected features.
- Sediment transport (ST): The ST module simulates transport of sediments in collection system and river networks. It is not available for 2D overland.
- Data assimilation (DA): The DA module includes an updating feature for continuous processing and updating of model states during simulations. Data assimilation is used for many types of applications, but in particular for real-time forecasting where the forecasted values of network state conditions (water levels, flows, etc.) are much more accurate and reliable when update and error estimation are included. It is designed for river networks.

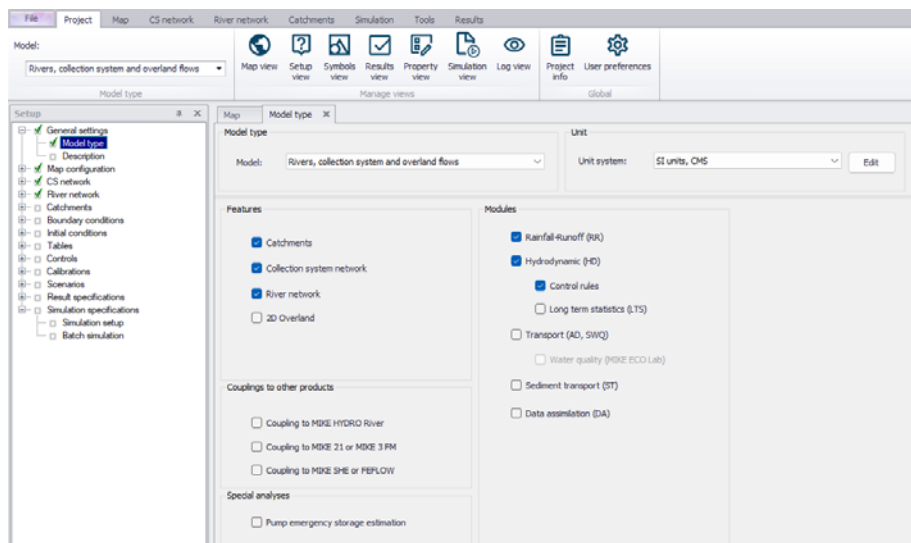

Figure 1.1 Model type and module selection



The following couplings to other MIKE products are also available:

- Coupling to MIKE HYDRO River: When this is active, the desired MIKE HYDRO model setup file must be selected in the 'River model' page. Note that coupling AD module with MIKE HYDRO is allowed and automatically enabled when the 'Transport (AD, SWQ)' module is also included in the simulation setup. AD components' names in MIKE HYDRO must, however, be identical to the components' names in MIKE+.
- Coupling to MIKE 21 or MIKE 3 Flow Model FM: When this is active, the desired MIKE 21 FM or MIKE 3 FM model setup file must be selected in the '2D / 3D overland model' page. Note that this coupling cannot be enabled at the same time as the 2D overland feature, since only one source of overland model can be used at a time.
- Coupling to MIKE SHE or FEFLOW: When this is active, it is possible to define parts of the river network to be coupled to a MIKE SHE or FEFLOW model. The network simulation file (\*.m1dx file) must then be exported from MIKE+ for use in MIKE SHE or FEFLOW. This also allows coupling the collection system network to MIKE SHE: in that case, the corresponding coupling file (\*.couple) must also be exported from MIKE+ for use in MIKE SHE.

When the different features and modules are activated, the corresponding menus will be added in the Setup view. Note that the features and modules are actually included in a simulation only if they are also included in the simulation definition, from the 'Simulation setup' editor.

The 'Pump emergency storage estimation' option enables a special type of analysis for collection system networks, enabling extra simulation options under the 'Special analysis' group in the Setup tree view. It estimates the time and volume available prior to an overflow at the wastewater pump station assets in the event of system failure.

## 1.2 Description

The General Settings section contains the Description editor. This editor allows addition of information about the project and a free text description of the model. It may also be used as a model build log to make notes on updates and amendments.

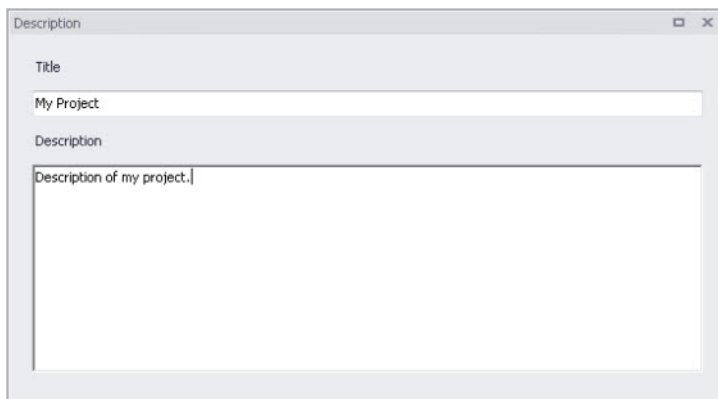

Figure 1.2 The Description Editor



## 2 Map Configuration

The Map Configuration section contains information on the coordinate system used in the MIKE+ project and presents options for customising the background image.

### 2.1 Coordinate System

The Coordinate System dialog (Figure 2.1) displays the Projection system used in the project.

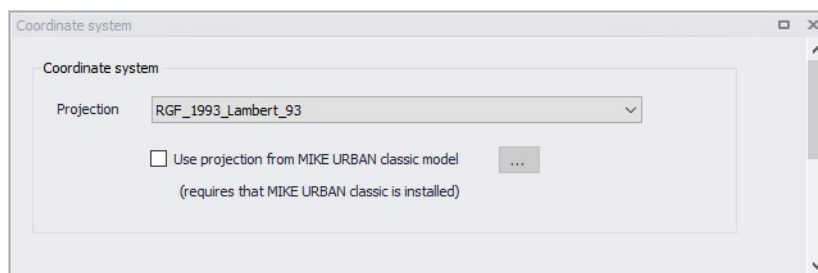

Figure 2.1 The Coordinate System dialog showing information on the projection system used in the project

The Projection can be selected from the short list, or by searching the projection amongst all the map projections available in MIKE+. The latter is achieved by selecting the <Browse...> option at the bottom of the list: this will open a window listing the available projections, and where it is also possible to import new projections from a projection file (\*.prj file).

Alternatively, the map projection may be read from a MIKE URBAN classic file. If MIKE URBAN classic is installed on your computer, you can tick the corresponding option, select a MIKE URBAN classic file and the same projection will be used afterwards in MIKE+.

When changing the map projection, it is possible to reproject geographical data in the project, for example to convert the coordinates of the network and catchments data, or mesh arcs used for the creation of the 2D domain. Some data files used as input for the simulation can however not be re-projected: this is especially the case for an external 2D domain file (\*.mesh or \*.dfs2) or external 2D data file used to map input parameters (e.g. \*.dfsu or \*.dfs2 file used to map the 2D surface roughness).

The same options for selecting the Projection are also used in the 'New Module Setup' window when a new MIKE+ project is created (Figure 2.2).

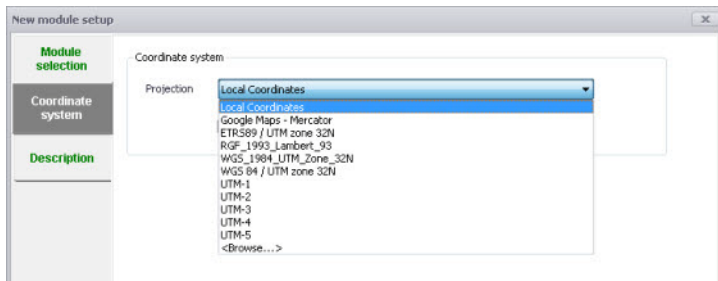

Figure 2.2 Specify the projection system for a new MIKE+ project on the New Module Setup window

## 2.2 Background Map

The Background Map editor allows the user to select a background image to show on the Map View in MIKE+ (Figure 2.3).

Activate a background map overlay by ticking the 'Visible' checkbox on the editor.

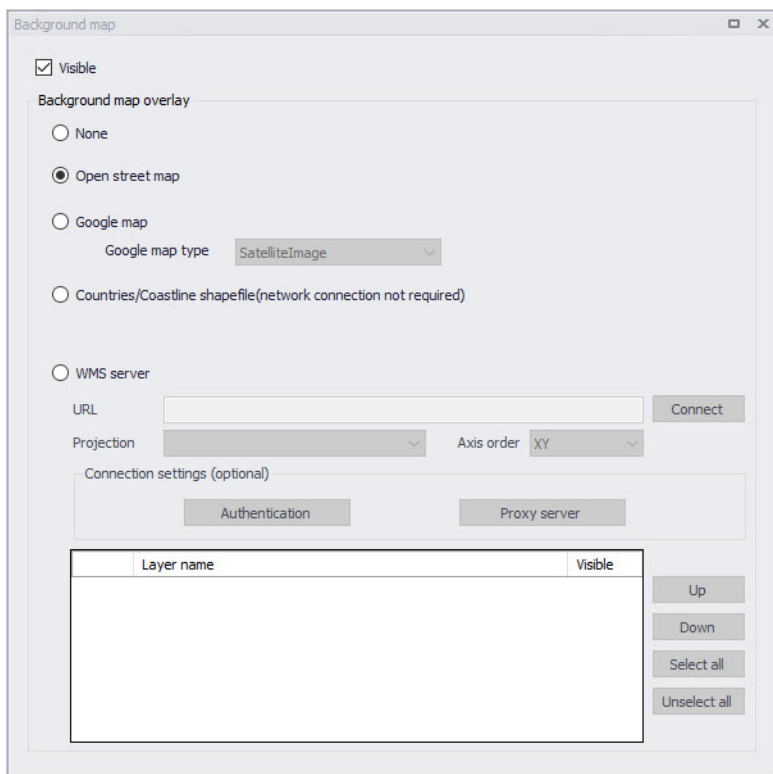

Figure 2.3 The Background Map Editor



The following background map overlay options are available:

- **None**
- **Open Street Map**
- **Google Map.** Select the Google map type to display (i.e. Street map, Satellite image, Terrain, or Hybrid).
- **Countries/Coastline Shapefile.** Polygon feature showing coastlines and demarcating oceans and inland areas.
- **WMS server.** Background maps obtained from a remote server. Enter the URL of the server and click 'Connect'. If the server is a private server, you will need to supply the user name and password by using the 'Authentication' button, and you may optionally tick 'Save password' in order not to enter it again the next time you open MIKE+. If your network uses a proxy server, you will need to press the 'Proxy server' button to provide the server address (which should include the port number, if any) as well as optional user name and password for this proxy server. When the connection is established, the table will provide the list of layers available on the WMS server, and it is possible to select which layers to display in MIKE+ using the 'Visible' box. The list of projections will show the map projection(s) supported by the WMS server, and the one used for the model data in MIKE+ will be selected if possible. Note that displaying layers from a WMS server requires that the MIKE+ project uses the same map projection as the WMS layers: if the projection used in MIKE+ doesn't match any of the projections supported by the WMS server, you will be asked to update the map projection in MIKE+. Also note that it is only possible to connect to WMS servers using projected map projections (geographical coordinate systems not supported). An axis order also needs to be specified, defining the format of the coordinates on the WMS server: most of the servers provide coordinates in the XY order, but some servers provide coordinates in the opposite order and in this case the option must be changed to 'YX' otherwise the layers won't be displayed on the map.

An internet connection must be available for Open Street Map, Google Map and WMS server overlays (Figure 2.4).

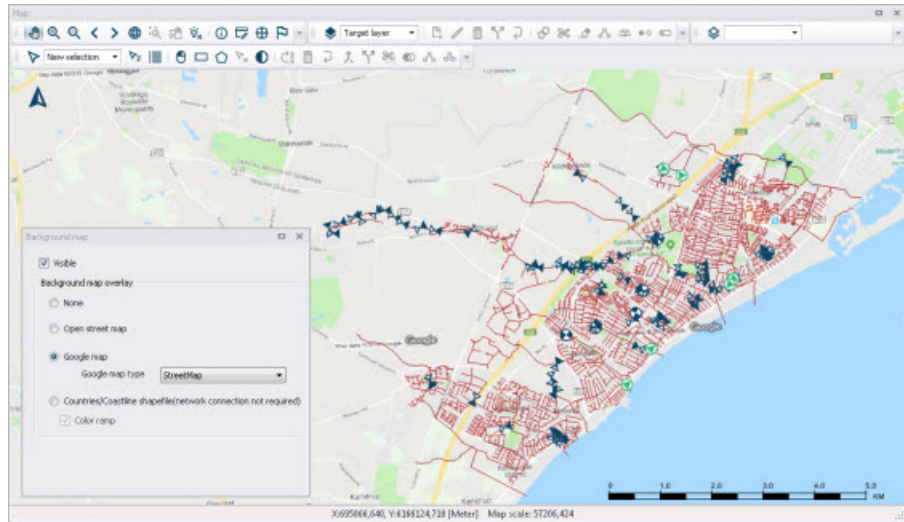

Figure 2.4 An example Google Map background on the Map View in MIKE+



Note: Because the proxy server settings are related to your local network and not to the model database, these settings are stored on the local machine instead of the MIKE+ project files. That means that the specified settings will then apply to other MIKE+ projects opened on the same computer. On the opposite, the proxy settings will have to be supplied again if the same model database is later opened from another computer connected to the same network.





## 3 River Network Hydraulic Modelling

### 3.1 Introduction

The MIKE+ Rivers module provides a platform for building and executing one-dimensional river models for a large variety of river-related project applications.

Typical application areas for river models include river hydraulics analysis, flood analysis and alleviation design studies, real time flood or drought forecasting, ecology and water quality assessments in rivers and wetlands, and water quality forecasting, among others.

A river model in MIKE+ is described with:

- River branches
- Cross sections
- Bed roughness
- Culverts
- Weirs
- Gates
- Direct discharges

The succeeding sections provide information on the MIKE 1D river network data model and associated editors in MIKE+.

### 3.2 Definition of a MIKE 1D Network

A MIKE 1D river network can be defined within MIKE+ by:

- Import of existing MIKE+ Project
- Import of external river model data (e.g. GIS) into MIKE+
- Graphically digitizing and manual data typing within MIKE+

The last option is frequently used in combination with one of the previous options to efficiently build a model in MIKE+.

It is recommended to define a spatial reference your network so that features are correctly geographically located.

### 3.2.1 Digitise a River Network on the Map

Digitise river networks directly on the Map. Use tools from the Edit Features toolbox on the River Network menu ribbon to digitise river networks on the Map (Figure 3.1).



Figure 3.1 The River Network menu ribbon

Set the Target Layer to 'Rivers', and use the 'Create' tool to draw the river network on the Map (Figure 3.2). Left-click to set river branch vertices, right-click to remove the last defined vertex, and double-click to end the drawing.

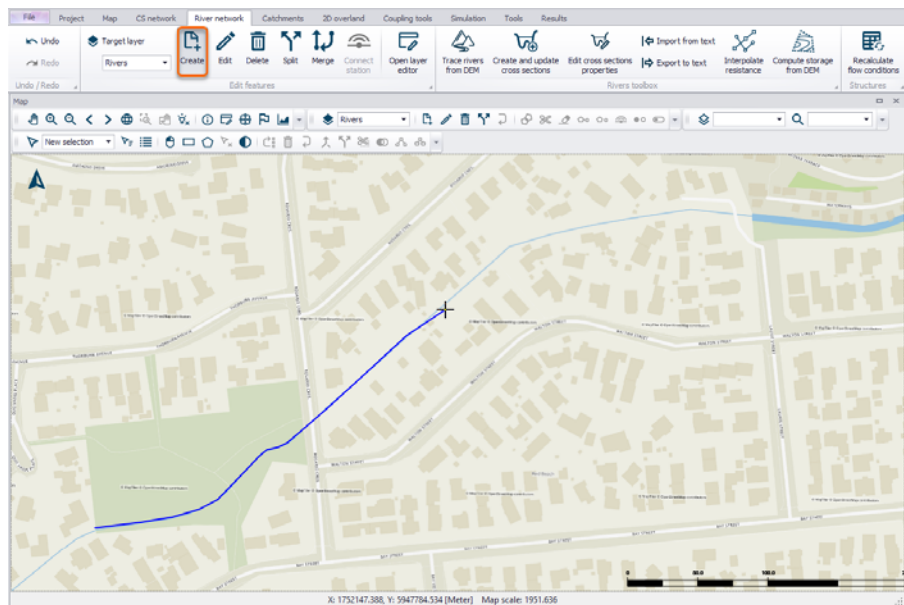

Figure 3.2 Use the 'Create' tool to digitise River features on the Map.

Use the 'Edit' tool to modify river branch features on the Map. While editing, left-click on an edge to add a vertex. Double left-click on an existing vertex to delete it. Move an existing vertex by clicking on it and dragging the point to the new location. Right-click outside the feature to stop editing and save edits.

One may use a background map to help with digitising river networks on the Map.



### 3.2.2 Import River Network Data

River network data may be imported from external file sources (e.g. shapefile) using the Import and Export tool in MIKE+ (Figure 3.3).

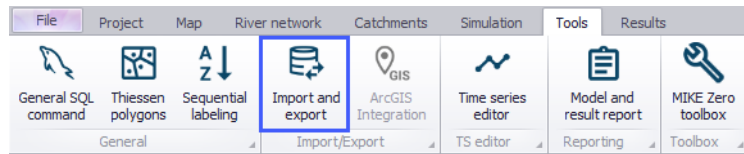

Figure 3.3 The Import and Export tool from the Tools menu ribbon

The database tables relevant for river networks in MIKE+ have a prefix of 'mrm\_'. For example, one may import river branch/alignment information (i.e. Rivers data layer) through the mrm\_Branch data table.

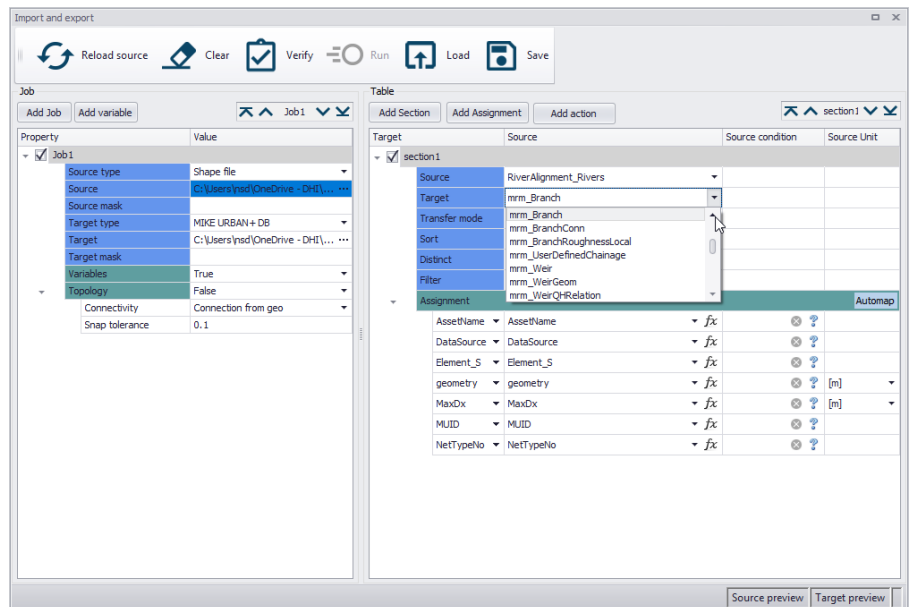

Figure 3.4 Configure data imports into relevant tables for river networks in MIKE+

More details on the Import and Export tool are found in the MIKE+ Model Manager User Guide Chapter 6 Import and Export.

## 3.3 Rivers

The river network is the basis of river model computations in MIKE+. The river network is defined as a combination of connected river segments and

computational points. Module-specific features are added using the river network as a base.

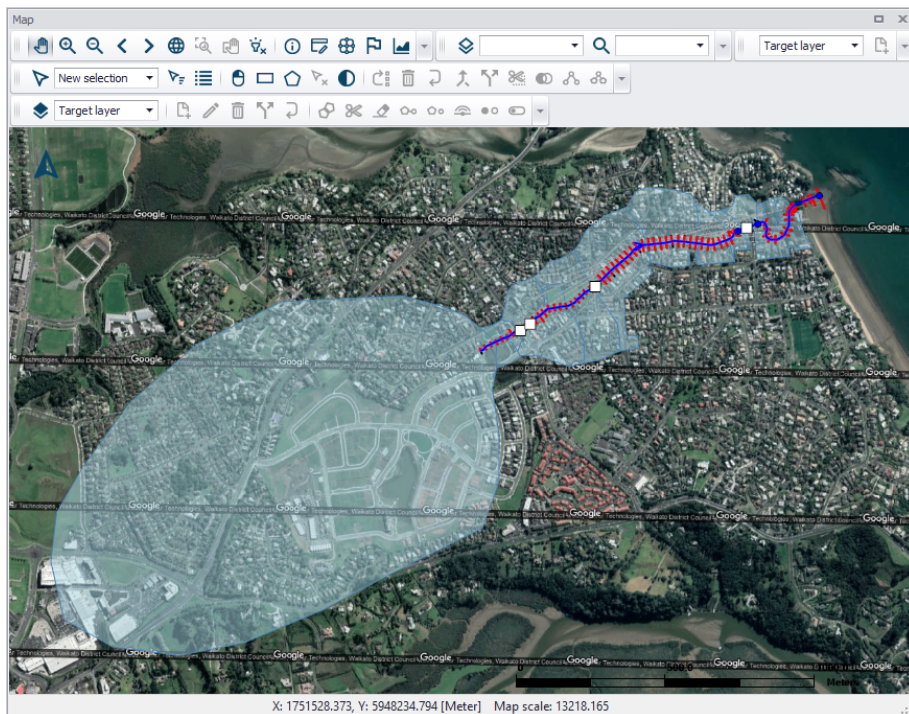

Figure 3.5 Example of a river network in MIKE+

River networks may comprise of a single or several river segments or branches, and options for connecting river branches as well as defining specific chainage points are available.

River model calculation points comprise of h- and Q-points:

- **h-points:** Water level (h) calculation points. All cross sections as well as start- and end-points of river branches are h-points in the model. Moreover, h-points are automatically inserted to ensure that the maximum distance between h-points (i.e. grid spacing) is less than or equal to the defined 'Max dx' value.
- **Q-points:** Discharge (Q) calculation points. Q-points are automatically inserted midway between h-points in the entire model area. Additionally, hydraulic structures are included as Q-points in the numerical model.

Inflows to the River network are defined through Boundary Conditions River Network.

The Rivers editor contains data on defined river branches in MIKE+.



One may use the 'Insert' button to add river branch data in the editor.

It is however recommended to define river branches via the main Map or through import of geometric data (e.g. shapefiles) for quicker definition of river alignment coordinates. See Definition of a MIKE 1D Network (p. 19).

Use the 'Delete' button to remove river branch data from the editor.

	Name	Apply	Upstream	Upstream type	Chainage [m]	Downstream	Downstream type	Chainage [m]	Topo ID	Max dx [m]
1	GRONAA-TM	<input checked="" type="checkbox"/>				VIDAA-MEL	River	1250	TOPO-95	10000
2	LINDSKOV	<input checked="" type="checkbox"/>				SEJERSBK-NED	River	320	TOPO-95	10000
3	SEJERSBK-NED	<input checked="" type="checkbox"/>				VIDAA-NED	River	8775	TOPO-96	10000
4	SONDERAA	<input checked="" type="checkbox"/>				VIDAA-MAG	River	790.178	Topo-93	10000
5	VIDAA-MAG	<input checked="" type="checkbox"/>				VIDAA-NED	River	0	TOPO-92	10000
6	VIDAA-MEL	<input checked="" type="checkbox"/>				VIDAA-MAG	River	53	TOPO-96	10000
7	VIDAA-NED	<input checked="" type="checkbox"/>							TOPO-92	500

Figure 3.6 The Rivers editor

## Identification

General properties for river branches are specified under the Identification group:

- **Name:** The descriptive name of the river. Multiple rivers can have the same name, if they are defined with a different range of chainages.
- **Apply:** This check box allows to toggle the Active status of the river on and off. The simulations will omit all rivers (and their structures) that are not active.
- **Connections:** Provides information on upstream and downstream linkages to other networks. Connections may be to other river networks or to Collection System Networks.

Define connections using the corresponding ellipsis button or arrow beside the Upstream or Downstream connection input box.



Figure 3.7 Connections groupbox

The ellipsis button gives access to the ID Selector window from which one may select a CS node or river branch element to connect from the list of available nodes or river branches in the project (Figure 3.8).

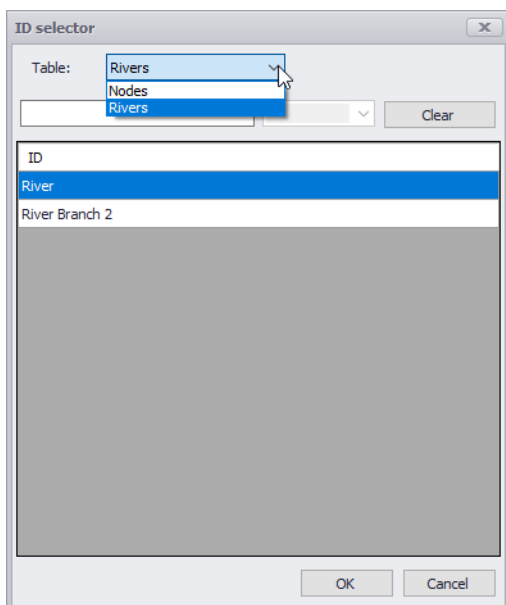

Figure 3.8 Select an element to connect from the list of available Nodes or River branches in the project presented in the ID Selector window that is accessed via the ellipsis button.

Alternatively, define river branch connections via the main Map using the arrow button.

Define the location of the connection to another river branch via the 'Chainage' input box.

## Geometry

Geometric information for a river branch are defined via the Geometry tab in the editor.



Figure 3.9 The Geometry tab page on the Rivers editor.

### Topo ID

Define a cross section data set for a river branch via the Topo ID input box. Use the ellipsis button to access the ID Selector window, which lists available topographical data sets for a river branch (Figure 3.10).

Topo ID is an abbreviation for 'Topographical Identifier', which refers to the same variable defined as part of cross section definitions. Also see Cross Sections (p. 34).

The cross section file accessed via the Cross Sections editor offers the possibility to store several measurement campaigns (e.g. from different years or before and after the construction of a structure), and these are identified through different Topo ID's. This is to enable simulation of alternative scenarios once the river network has been configured. The topographical data used in a simulation is defined by the Topo ID.



Note that the River ID in the Rivers editor must correspond to the Branch ID in the cross section file for data presented in the Cross Sections editor to detect available cross sections data for a river branch in the Rivers editor.



Figure 3.10 Select a TopoID for a river branch from the list of available sets on the ID Selector window accessed via the ellipsis button.



### Max dx

The grid spacing or the maximum distance between two adjacent water level (h) calculation points in the numerical scheme used during river model simulations.

Calculation points in the River model are defined as follows:

- At locations where Cross sections are present in the cross section file, h-points are always created.
- At locations where rivers are connected, a 'connection node' is created internally in the simulation engine and h-points are automatically created at these locations as well (in case connections are defined where no cross sections are defined).
- If the defined value of Max dx is smaller than the distance between cross sections, a number of additional h-points are automatically inserted at engine-defined locations to ensure that the maximum distance between h-points is less than or equal to the defined Max dx. The additional h-points generated from the Max dx criteria in the model use linearly interpolated values for hydraulic parameters (i.e Area, Radius, Width, etc.) from the nearest physically defined up- and downstream cross sections.

Max dx may therefore be used to increase the spatial resolution of the river model by forcing an additional number of calculation points between physically-defined cross sections. (The lower the Max dx value, the higher the resolution).

### Flow direction

The flow direction may be set as positive or negative, and indicates how the chainage definition is interpreted with respect to the flow direction.

If flow direction is defined as positive, the main flow direction will be assumed to go from low chainages to high chainages in the river branch and the corresponding discharge will get a positive sign in the results (whereas the reversed flow direction will get a negative sign). If flow direction is defined as negative, the main flow direction is defined in the opposite way: positive discharge results will describe water flowing from high chainages to low chainages, and negative results in the opposite direction. This main flow direction is per default reflected with an arrow along the river on the map.

The default assumption is to define flow direction positive with increasing chainages looking downstream of the river. Hence, if a river has been defined with chainage 0 (zero) at the river mouth and chainages increasing upstream, the flow direction must be defined as negative.

The 'Flow direction' also controls the definition of the left and right sides of the river, which are important for the correct definition of cross sections: the sides are observed looking in the direction of the main flow:





- For a positive flow direction, the left and right sides are observed looking in the direction of increasing chainages
- For a negative flow direction, the left and right sides are observed looking in the direction of decreasing chainages.

### Start chainage

The chainage of the first point in the river branch. To change this chainage, it is required to insert a User defined chainage point in the first point of a branch.

### End chainage

The chainage of the last point in the river branch. To modify this chainage, a User defined chainage point must be inserted in this last point of the branch.

### River type

There are three different river types available:

- **Regular:** A regular river is a 'normal' river consisting of a number of computational points defined from cross sections. A minimum of one cross section is required. The hydrodynamic simulation in a regular river is based on a solution of the de Saint-Venant equations.
- **Structure link.** A structure link is typically a short river used to connect a flood plain to the main river. Structure links do not require cross sections to be specified but a river structure must be specified on the river and the hydrodynamic simulation is therefore based on an energy loss calculation.
- **Simple routing.** Routing is a simplified hydraulic calculation. The concept of routing is basically the transformation of a hydrograph entering at the upstream end of a branch into a downstream outflow, using a simple equation. Cross sections are not necessarily required on routing rivers. Routing options are defined in the 'Routing' tab of the Rivers editor.

A structure link generally represents the embankment geometry between parallel rivers (e.g. main river and flood plain river) or between a main river and a storage area. Structure links are modelled as a single structure river of only three computational points (h-Q-h). A structure link doesn't require cross sections to be defined: the h-points are automatically assumed to be made of very wide geometries. The Q-point in the middle of a structure link is defined through a structure, and any type of river structure is accepted. This structure must be specified in the corresponding structure editor (e.g. Culverts editor), but when changing the river type to a Structure link, MIKE+ offers the option to automatically insert an 'open culvert' type of structure, which can represent an overflow weir with a length to include the friction loss component and which is well suited for describing overbank spilling. The friction loss is computed using the length defined by the upstream and downstream chainages of the river.

Typical structure links describing overbank spilling is illustrated in Figure 3.11.

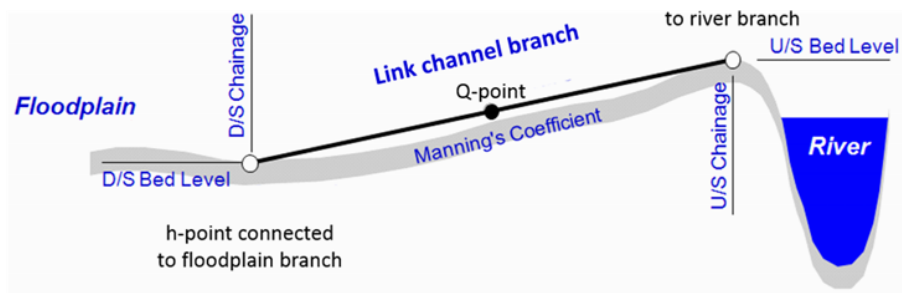

Figure 3.11 Longitudinal representation of a link channel



Note that following the internal formulation of the structure link where no true cross sections are defined in a structure link, the usage is restricted to Hydrodynamic simulations ONLY. Thus, for e.g. Water Quality calculations the setup should be void of structure links. They should in that case be replaced by 'regular' rivers with actual cross sections defined.

Routing can be used to model the hydraulics of upstream tributaries and secondary rivers, where the main concern is to route water to the main rivers.

Routing is a simplified hydraulic calculation. Normally, simulation of hydrograph mitigation along a river is based on the shallow water equations, which require cross section information. However, routing doesn't require such cross sections. The concept of routing is basically transformation of a hydrograph, i.e. calculating the modified hydrograph (different peak value and adjusted shape) at a given location based on the hydrograph at the upstream point and simple parameters. Typically, routing may be used to represent a reach of a river, a reservoir or a structure.

Note that the following applies to routing rivers:

- Routing rivers cannot be used to model a looped part of a river network.
- Use of routing rivers requires that all rivers located upstream of a routing river are also routing rivers. Routing can however be combined with regular rivers, if these are located downstream the routing rivers.
- Runoff from catchments can be included in a routing river.
- The routing method does not support the use of structures on routing rivers.
- The routing method does not account for backwater effects.
- If no routing point is inserted in a routing river (in the 'Routing' tab), the outflow will equal the inflow.

### Edit coordinates

In some cases it might be necessary to update the coordinates of the vertices of the river branch on the Map.



When a specific river branch is selected in the overview table, click on the Edit coordinates button to access the Edit Coordinates of Vertices dialog (Figure 3.12). This table contains the X and Y coordinates of the vertices of the selected branch, which can be edited (copy and paste is also supported).

New rows may be added or existing rows deleted. 'Insert' adds a new row before (above) the active row and 'Append' adds a new row after (below) the active row.

Click on OK to update the river branch alignment on the Map after changes.

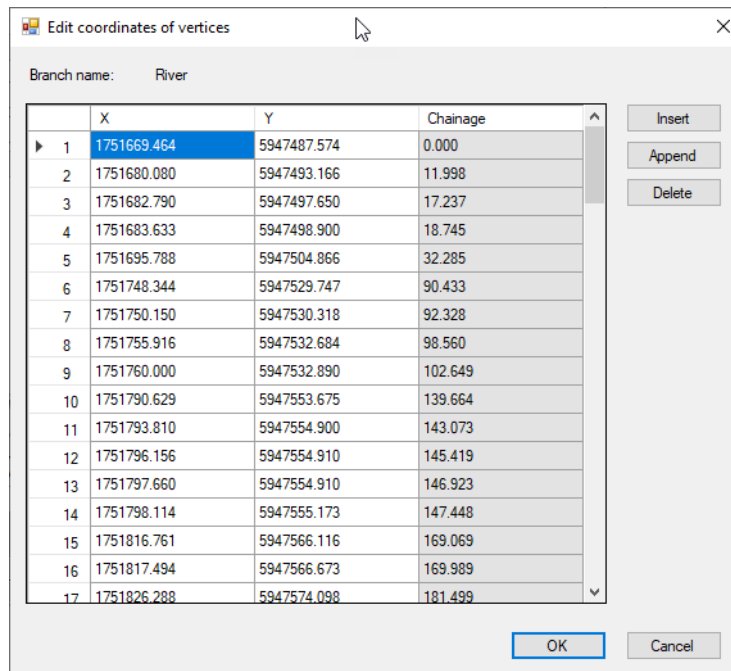

Figure 3.12 The Edit Coordinates of Vertices dialog

## Chainage Points

A user defined chainage point is a specific location with a controlled chainage. Data on user defined change points are listed in the Chainage Points tab page of the Rivers editor (Figure 3.13).



Geometry	Chainage points	Wave approximation	Routing	Description
Delete 1/4 rows, 0 selected				
User defined chainage				
	X [m]	Y [m]	Chainage [m]	
▶ 1	485721.511229132	6089743.8036166	1	
2	484204.320827162	6090104.87431074	1778.788	
3	483139.164574977	6090258.60936712	2914.733	
4	481839.363259051	6090494.47789942	4324	

Figure 3.13 The Chainage points tab page in the River editor

If a river branch does not contain any user defined chainage points the start chainage is per default set at 0 chainage and the end chainage equivalent to the length of the branch calculated based on the geographical length of the branch shape. Both the start and end chainages may be controlled by inserting user defined chainage points.

The chainage along a river branch between two user defined chainage points are linearly calculated between the two defined chainage values. The chainage along a branch between a user defined chainage point and a branch end is calculated as the geographical distance from the defined chainage value.

Add user defined chainage points to the River network via the main Map.

Use the Edit Features toolbox on the River Network menu ribbon (see Figure 3.1). Set the target layer to 'User defined change' and use the 'Create' tool to define user defined chainage points on the Map.

The coordinates and chainages for user defined chainage points defined on the Map are shown on the table in the Chainage Points tab page on the Rivers editor.

Use the Delete button on the Chainage Points tab page to remove user defined chainage points. The Delete tool from the Edit Features toolbox may also be used to remove user defined chainage points via the Map.



**Note:** If a user defined chainage point is moved, the defined chainage is fixed and hence moving the point will update all chainages along the river branch.



**Example:** A river branch without user defined chainage values is created with a geographical length of 1000 m. The start chainage will be 0 and the end chainage will be 1000.

A user defined chainage point is added at 500 m (geographically) along the branch and given the chainage 750. The start chainage is now automatically updated to 250 and the end chainage to 1250.

Another user defined chainage point is added at 250 m (geographically) along the branch and given the chainage 100. The start chainage is now automatically updated to -150 and the end chainage is unchanged at 1250.



## Wave Approximation

Wave approximation refers to the numerical solution and number of physical terms included in the Momentum equation applied in the Hydrodynamic simulation. For further details, please see the MIKE 1D reference manual.

By default, the wave approximation is selected for the entire river network in the MIKE 1D engine configuration dialog in Model Manager. But it is possible to apply a different wave approximation for some rivers. When the option 'Use specified local wave approximation' is selected, then it is possible to select the wave approximation for the current river, which will take priority on the global wave approximation.

## Routing

The 'Routing' tab contains definitions of locations and properties for routing points along the river. A routing point is a location where a routing procedure is active, that is where change in hydrograph appearance occurs.

If no routing point is inserted in a routing river, the outflow will equal the inflow.

To allow for the insertion of routing point into a river, the river type must be defined as 'Simple routing', in the 'Geometry' tab. Routing points can be added or deleted using the 'Insert' or 'Delete' buttons above the table in the 'Routing' tab.

Multiple routing points can be defined on the same river if required.

### Simple routing location

Specify the name and location of a routing point:

**ID.** String identification of the routing point.

**Chainage.** Chainage at which the routing method is applied. The chainage of a routing point will have effect on the downstream node in the river where the routing point is defined.

### Flow routing method

Three routing methods are available. These methods are:

- **Muskingum:** a routing method that requires two parameters to be specified to describe the delay and the shape of the modified hydrograph. These parameters are fixed in time and space.
- **Muskingum-Cunge:** a modified version of the Muskingum routing method, for which the two parameters are automatically computed based on the diffusive wave model. The parameters are recomputed at each time step of the simulation. Hence, this method doesn't require any additional parameter to be specified by the user.



- **No flow routing:** the hydrograph is not transformed while passing the current routing point.

When the Muskingum method is selected, the two additional parameters below must also be specified.

**Delay parameter.** Time for the hydrograph to travel between the selected river node and the next downstream node. Its value may also be estimated as the observed travel time of the flood peak between the nodes.

**Shape parameter.** A dimensionless factor controlling the shape of the modified hydrograph. This factor depends on the shape of the modelled wedge storage and must be between 0 and 0.5. In natural rivers, it usually has a value between 0 (reservoir type storage) and 0.3, with a mean value of 0.2.



Note: the Muskingum-Cunge method computes the delay parameter and the shape parameter using the flow width and the flow area, and it therefore requires that a cross section exists at the routing location.

### Water level method

Routing rivers do not per default consider any water level, as the primary purpose is to route a hydrograph through the river system and hence, only the discharge is a key state variable. It is, however, possible to determine water levels using one of the methods below:

- Rating curve
- Manning formula.

Both methods apply for steady-state flows and are thus approximations, but they are usually reasonable estimates as long as the water level does not change rapidly (e.g. during a flood).

When the 'Rating curve' method is used, it looks up the water level in a user specified Q-h relation table, selected from the list of tables defined in the 'Curves and relations' editor. The table must cover the range of discharges encountered during the simulation, and must be defined with the type 'QH relation'.

When the 'Manning' method is used, the Manning formula is applied during the simulation:

$$Q = 1/n \cdot A \cdot R^{2/3} \cdot \sqrt{S} \quad (3.1)$$

Where n is the Manning (n) number, A is the cross-sectional area, S is the water surface slope, R is the hydraulic radius or resistance radius. For these parameters to be computed, it is required to specify a cross section at the same chainage along the river in order to get hydraulic parameters from its processed data. If no cross section exists at this location, it is not possible to use the Manning formula option.



## Description

The Description tab page is where free text descriptions for river branch data may be added (Figure 3.14). It offers options for providing asset and model management information for river model data, as well as attributes for quick model data query.

- **Description:** Free text description for the river branch data.
- **Data source:** Free text describing data source for the river data.
- **Asset ID:** Associated asset management system ID for the river data, if any.
- **Status:** Project-defined status information that may be used for model build management or e.g. model data query. Pre-defined codes are contained in the Status Code editor (Figure 3.15) which may be accessed via the ellipsis button from the Status dropdown menu.
- **Network type:** Project-defined model network type that may be used for e.g. model data query.
- **Add picture:** Option for adding images associated with the river data.

The screenshot shows the 'Description' tab selected in a multi-tabbed interface. The tabs are: Geometry, Chainage points, Wave approximation, Routing, and Description. The 'Description' tab contains the following fields:

- Description:
- Data source:
- Asset ID:
- Status:
- Network type:

An 'Add picture' button is located to the right of the 'Asset ID' field.

Figure 3.14 The Description tab page on the Rivers editor

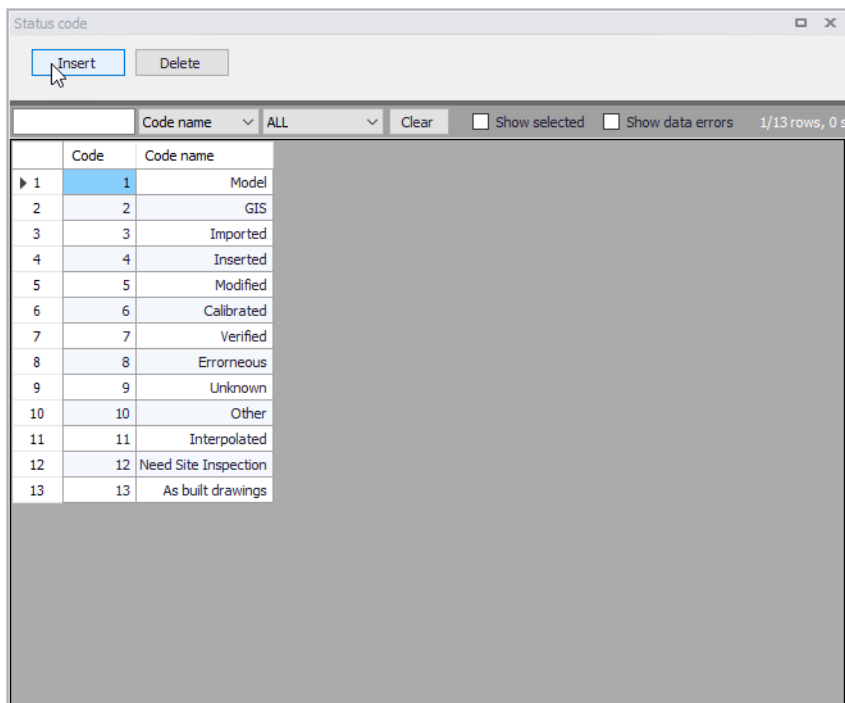

Figure 3.15 The Status Code editor

## 3.4 Cross Sections

River cross section data are essential in defining river network models, as they are used in determining conveyance and flow areas in solving the 1D shallow water equations during simulations.

Cross section data are stored in an external \*.XNS11 cross section file, which may be created, edited, loaded, and visualized via the Cross Sections editor under the River Network setup group in MIKE+ (Figure 3.16).

Cross sections may also be edited and shown graphically on the Map (Figure 3.17).

Cross sections data in the editor are presented under a number of windows, as shown Figure 3.16.



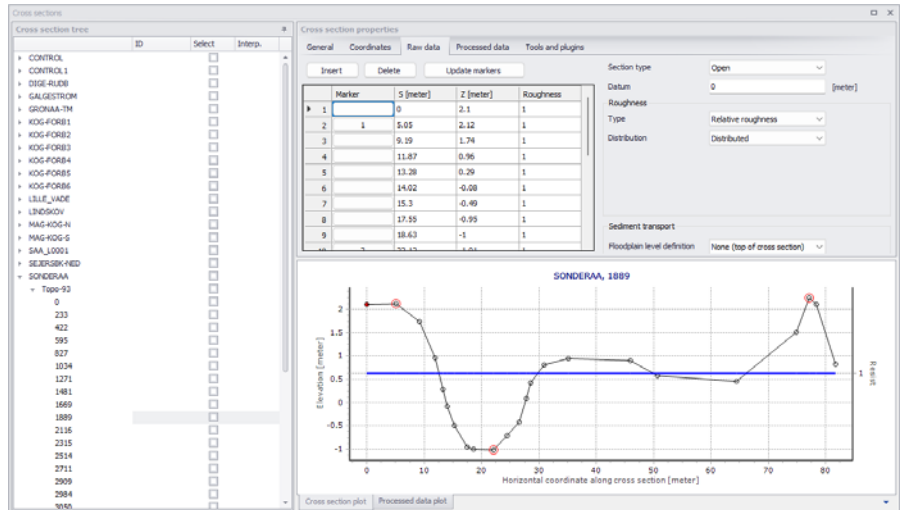

Figure 3.16 The Cross Sections editor in MIKE+

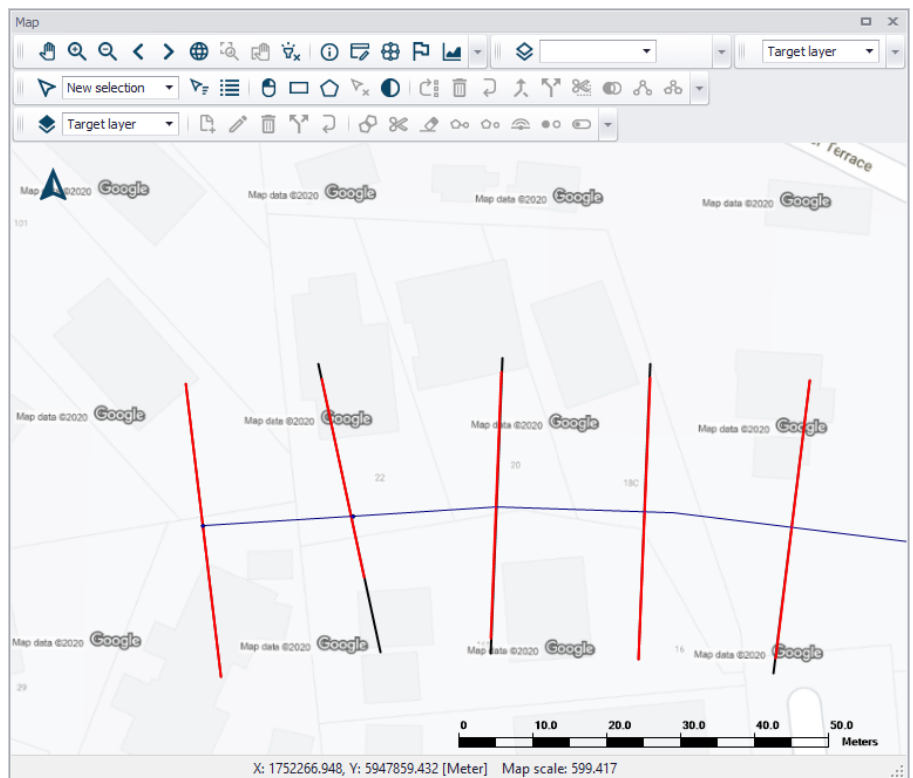
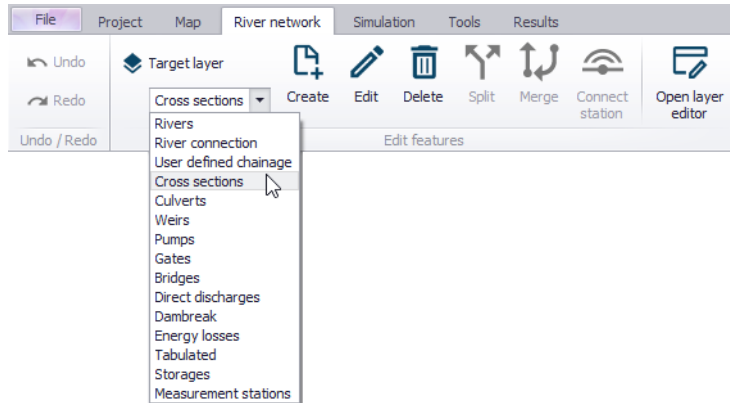

Figure 3.17 Cross Section lines shown on the Map



### 3.4.1 Inserting Cross Sections on the Map

Use tools from the Edit Feature toolbox on the River Network menu ribbon to insert and edit cross sections via the main Map.



Set the 'Target layer' to 'Cross sections' and use the 'Create' tool to insert a cross section via the Map.

Cross sections are defined as polylines. To add a new cross section line, click firstly on the required location of the bank on one side of the river and then click at all locations of intermediate points of the polyline. To stop digitising the cross section, double-click at the location of the bank on the other side of the river. The digitised cross section must always intersect with a river branch. The river branch name and chainage defining the location of the cross section are automatically defined by this intersection. The created cross section is automatically shown in the Cross Sections editor.



**Note** that inserting a cross section on the Map will set marker 1 at the point to the left of the river branch (taking the river Flow Direction into account), marker 3 at the point located to the right of the branch, and marker 2 where it crosses the river branch.

Cross sections that are drawn on the map will automatically be created with coordinates for each digitised points, linking them to the position specified. The use of these coordinates can be disabled in the Cross Sections editor.



**Note:** Cross sections with coordinates are fixed at the given location. This means that the chainage of the cross section used in the calculation may differ from the position shown on the map e.g. if the chainages have been edited after the cross sections have been drawn. Chainages may be updated using the tool 'Edit properties for multiple cross sections'.

To edit a cross section on the map, use the 'Edit' tool and click once on the cross section on the map. The vertices of the polyline are then shown on the map, and you can click and drag these vertices to edit the location of the



cross section. Clicking between two vertices will add a new vertex to the cross section.

Activate the **'Delete'** tool and click on a cross section on the map to delete it.



**Note:** Tools for automatic creation of cross sections (from e.g. survey points and/or DEM) or automatic import from text files are also available in the ribbon, in the 'River network' tab.

### 3.4.2 Cross Section Tree

The Cross Section Tree window on the Cross Sections editor shows a list of all cross sections available in the setup (Figure 3.18).

In the first column, cross sections are identified by their river name, Topo ID, and chainage.

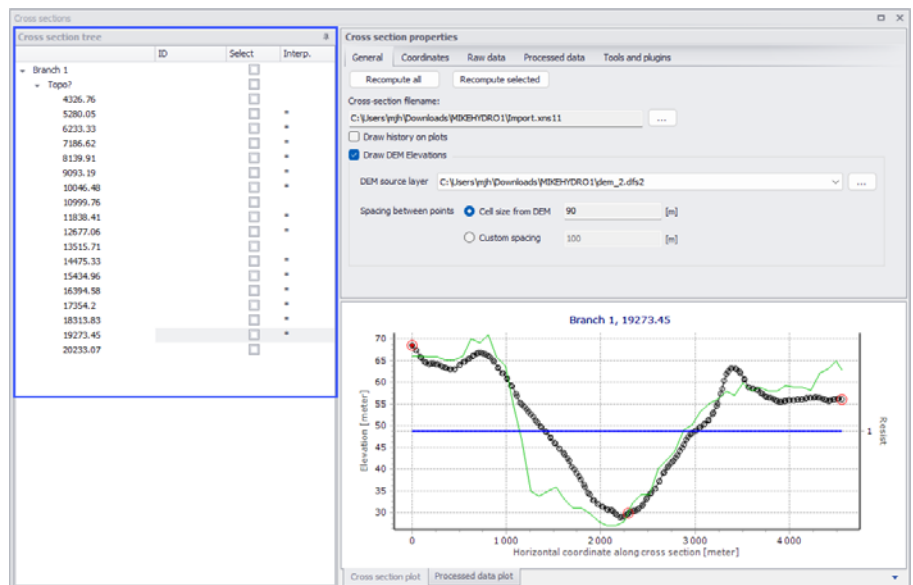

Figure 3.18 The Cross Section Tree window on the left side of the Cross Sections editor

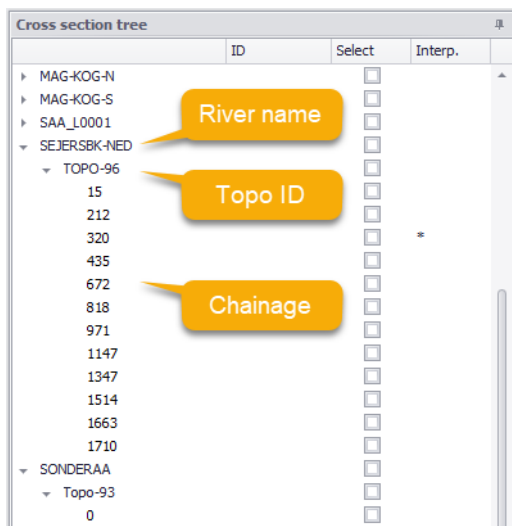

Figure 3.19 Cross Section Tree data columns

Clicking on a cross section in the tree view will show properties for this cross-section on the right-hand side of the editor (Figure 3.20).

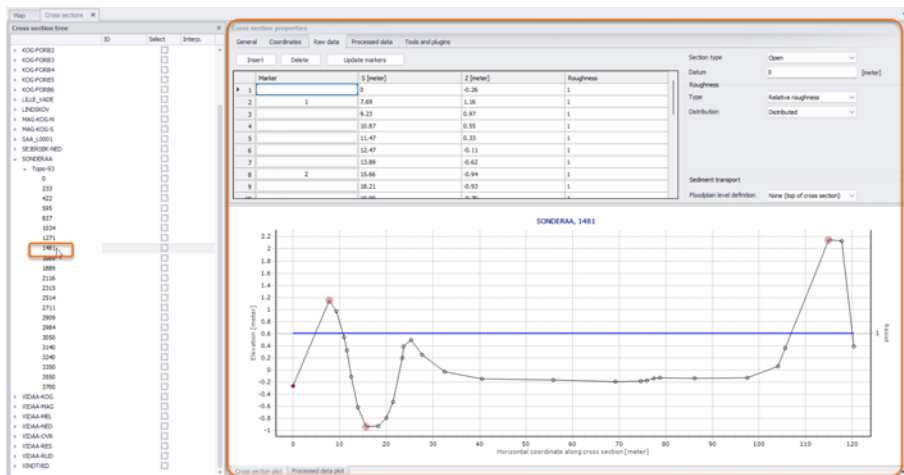

Figure 3.20 Cross Section Properties on the right side of the editor

Right-clicking in the first column gives access to options to edit the cross sections (Figure 3.21). The context menu options slightly vary according to where you clicked on the tree view. For instance, clicking on a single chainage allows editing the corresponding cross section only, whereas clicking on the Topo ID or on the river name allows editing all or a selection of cross sections.

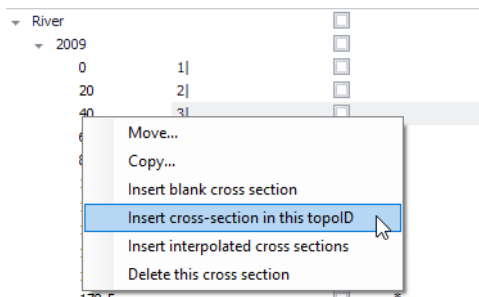

Figure 3.21 Context menu options when right-clicking on a cross section chainage

The ‘Move...’ option allows moving cross sections to different locations, by changing either the river name, Topo ID and/or chainage. When selecting the ‘Move...’ option, the dialog in Figure 3.22 appears, where the ‘From’ groupbox indicates which cross sections are being moved and the ‘To’ groupbox indicates the destination which has to be specified by the user.

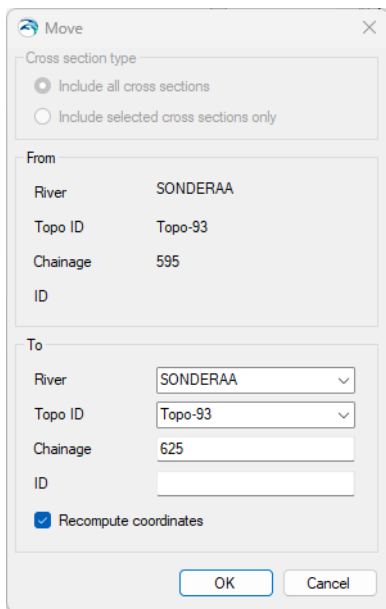

Figure 3.22 The Move dialog for relocating a cross section

The ‘From’ groupbox shows the original chainage only when moving a single cross section. It shows the Topo ID only when moving a single cross section or a group of sections from a given Topo ID.

If the option 'Recompute coordinates' is selected, the coordinates of the cross section will be updated, assuming that the cross section is a straight line perpendicular to the river, crossing the river at the location of the Marker 2. If the option is not selected, the coordinates will remain identical to the original coordinates, and therefore the cross section will remain at the same location



on the map despite the change of chainage. In case of inconsistency between the chainage location and the coordinates, the actual location used in the simulation will be the chainage value.



**Note:** The upper part of the dialog ('Cross section type') is only active when selecting 'Move...' from a river name or a Topo ID (Figure 3.22). It allows selecting between moving all the cross sections of the river/Topo ID, or only the selection. These options are therefore not relevant for moving a single cross section.

The 'Copy...' option is similar to the 'Move...' except that the original cross sections are kept at their original locations.

To insert a cross section, it is possible to use the 'Insert blank cross section' option, which allows creating a cross section on any river and for any Topo ID, specified as shown in Figure 3.23.

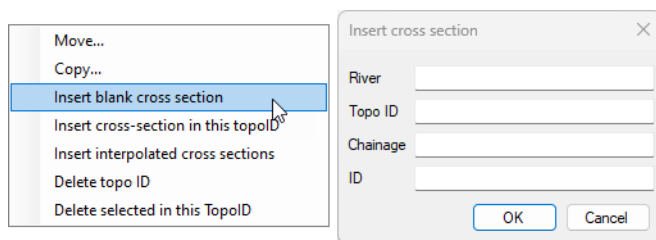

Figure 3.23 'Insert blank cross section' option dialog

Alternatively, the 'Insert Cross Section in this Topo ID' option allows inserting a cross section under the corresponding Topo ID. The Topo ID (and river name) are automatically filled, as illustrated in Figure 3.24.

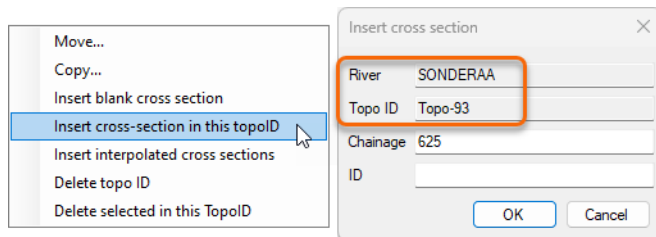

Figure 3.24 'Insert cross section in this topo ID' option dialog

The 'Insert Cross Section in this River' option is available from the context menu when right-clicking on the river name. It allows for inserting a cross section under the selected river name. The river name is automatically filled, and the Topo ID and Chainage need to be specified (Figure 3.25).

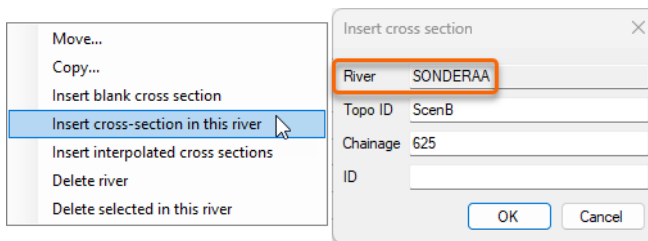

Figure 3.25 'Insert cross section in this river' option dialog

It is possible to insert additional cross sections interpolated from initially available (e.g. surveyed) data using the 'Insert interpolated cross sections' option from the context menu on the Cross Section Tree.

This opens the Insert Interpolated Cross Sections dialog shown in Figure 3.26, where the river name and Topo ID where interpolation shall be conducted must be selected. It is possible to interpolate a single cross section at a given chainage or multiple cross sections. In the latter case, a maximum distance between the interpolated cross sections must be specified, along with the range of chainages where interpolation is conducted.

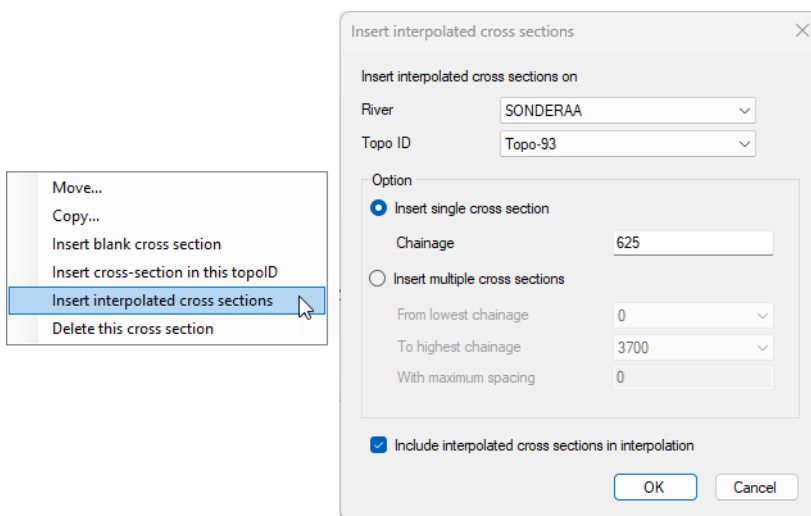

Figure 3.26 'Insert interpolated cross sections' option dialog



**Note:** Tools for automatic creation of cross sections (from e.g. survey points and/or DEM) or automatic import from text files are also available in the ribbon, in the 'River network' tab.

There are also multiple options for deleting cross sections. Right-clicking on a single cross section gives access to the 'Delete this cross section' feature. Clicking on the Topo ID allows deleting either all cross sections under this Topo ID (using the 'Delete topo ID' option) or only the selected sections under



the Topo ID (using the 'Delete selected in this topo ID' option). Finally, clicking on the river name allows deleting either all cross sections under the river (using the 'Delete river' option) or only the selected sections under the river name (using the 'Delete selected in this river' option).

The Cross Section Tree panel also has the following columns:

- **ID:** The second column contains user defined identifiers. To add or edit an ID, click on the field for the relevant cross section.
- **Select:** The third column contains a checkbox that allow selecting and deselecting cross sections. Selections may later be used to process multiple cross sections at the same time, for instance to edit their properties.
- **Interp:** The last column contains a symbol for cross sections created by interpolation from other cross sections. This allows keeping track of the origin of cross section data.



**Note:** Per default, cross sections are sorted by increasing chainage under each river and Topo ID. It is however possible to sort them by decreasing chainage by clicking in the header of the first column, or sort them by their attributes (ID, selected/unselected, interpolated) by clicking on the appropriate column header.

### 3.4.3 Cross Section Properties

The properties for cross sections are shown in the 'Cross Section Properties' panel on the upper right-hand side of the Cross Sections editor (Figure 3.27).

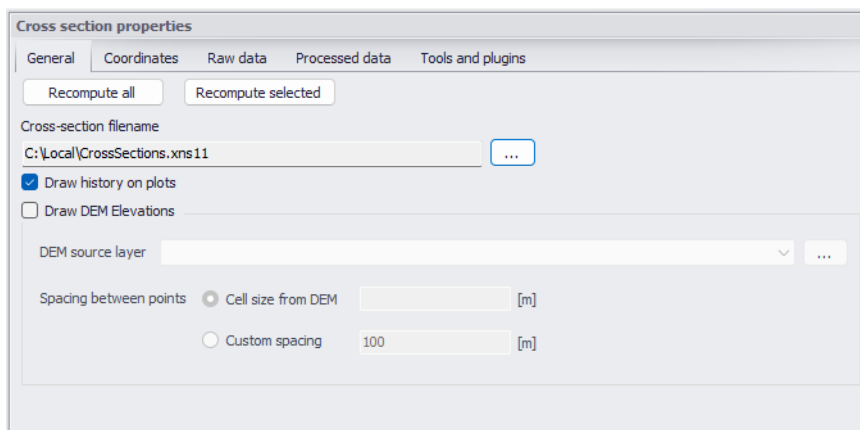

Figure 3.27 The Cross Section Properties panel on the Cross Sections editor

#### General

The General tab contains options and data which are relevant for all or part of all the cross sections.





- **Recompute all:** The 'Recompute all' button recomputes processed data for all the cross sections.
- **Recompute selected:** The 'Recompute selected' button recomputes processed data for only the selected cross sections (those having the 'Select' checkbox checked).
- **Cross-section filename:** Cross sections are stored in a cross section file with the \*.XNS11 file extension. Click the '...' button to either select an existing file or to create a new one.
- **Draw history on plots:** When this option is checked, watermarks are added as a history of previous cross sections drawn on the 'Cross section plot' and the 'Processed data plot'. This feature allows comparison of multiple cross sections on a single scale.
- **Draw DEM elevations:** When this option is checked, a green line is added on the 'Cross section plot', showing the elevations obtained from a selected DEM. This feature allows comparison of the active cross sections with e.g. a more detailed or more recent DEM. When this option is active, the following must be specified:
  - DEM source layer: the input raster file containing the DEM data, from which the DEM plots will be obtained.
  - Spacing between points: this is used to control the maximum spacing between points along the DEM line. By default, the maximum spacing is set to the cell size of the DEM raster. By changing to a custom spacing, any other custom value can be used.

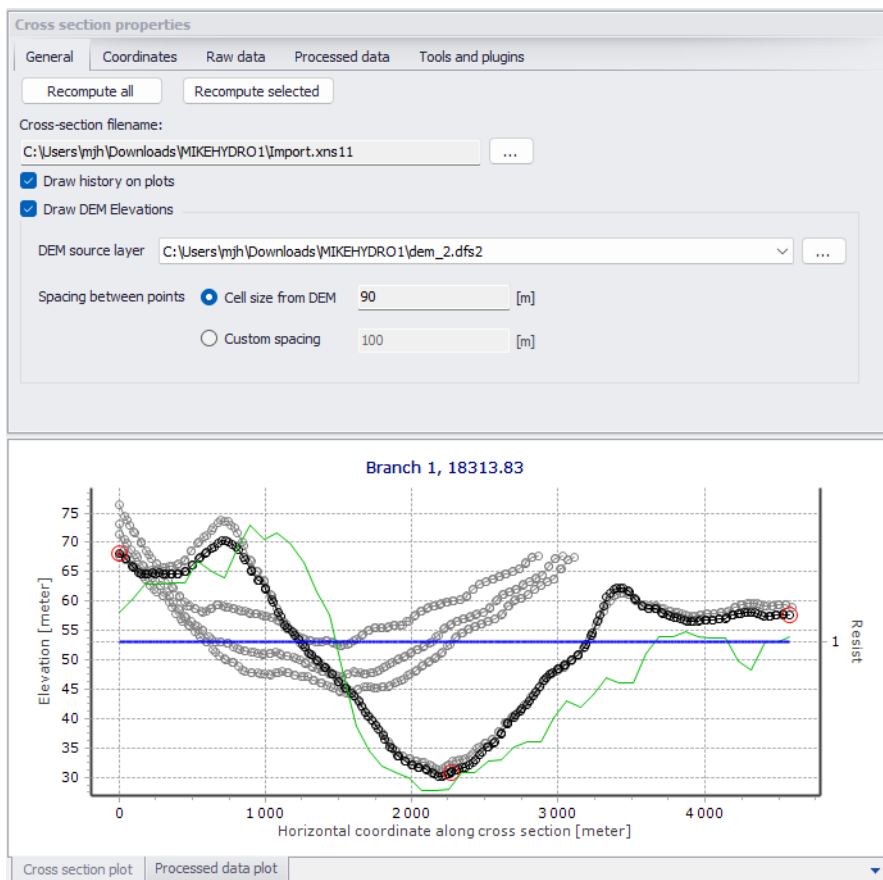

Figure 3.28 'Draw history on plots' option shows previous cross sections, 'Draw DEM elevations' shows a green DEM line.

## Coordinates

One may customize the location of cross sections via the 'Coordinates' tab on the Cross Section Properties panel. The tab page tabulates vertices defining the location of the cross section (i.e. the red cross section polyline shown on the map). Each row describes a point defined by its X and Y coordinates expressed in the coordinate system used for features in the setup. These vertices do not have to match the list of points provided in the 'Raw data' tab.

The coordinates in the table must be sorted from the left side of the river (at the top of the table) towards the right side of the river (at the bottom of the table). The definition of the left and right sides of the river depends on the selected 'Flow direction' of the river branch. Refer to the Rivers definition description for more details.

When cross sections have been created from the Map view, the table is automatically filled with all vertices defining the location of the polyline and one point at the intersection with the branch.



When coordinates are provided in the table, the 'Apply' option can be activated. When applied, cross sections are displayed on the map based on the defined coordinates. Otherwise, the cross section is displayed perpendicular to the branch at the specified chainage, using the length calculated from the 'Raw data' tab.

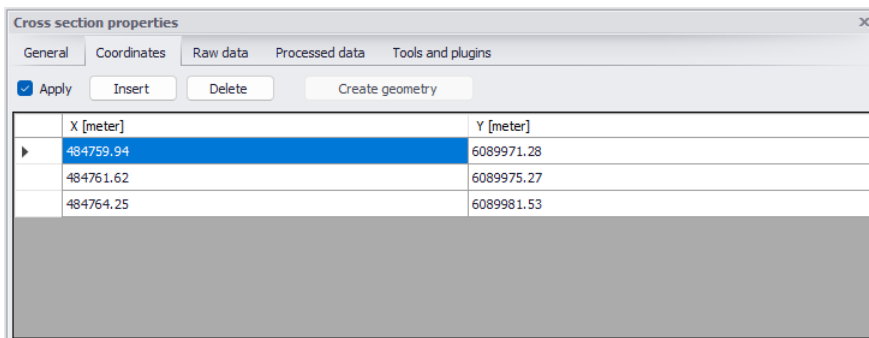

Figure 3.29 The Coordinates tab on the Cross Section Properties panel

### Raw Data

The 'Raw data' tab tabulates points defining the topography of the river bed along the cross section (Figure 3.30). These points do not have to match the list of vertices provided in the 'Coordinates' tab.

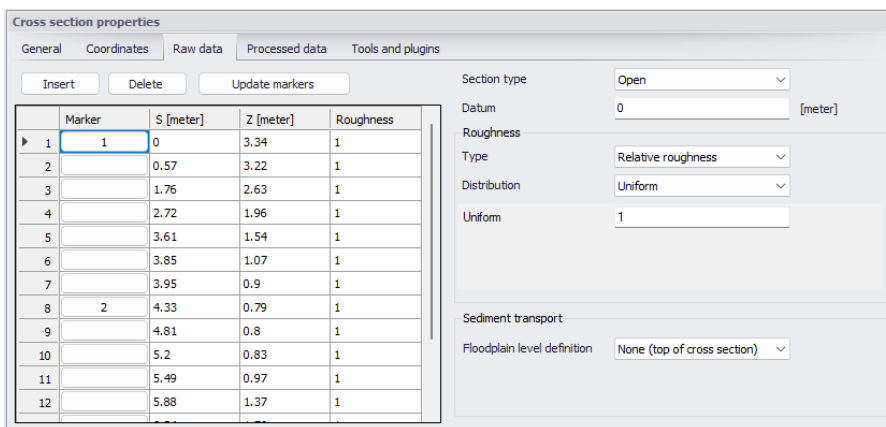

Figure 3.30 The Raw Data tab page on the Cross Section Properties panel

The 'S' column is the horizontal distance of each point along the cross section from the left end of the cross section. The points in the table must be sorted from the left side of the river (at the top of the table) towards the right side of the river (at the bottom of the table). The definition of the left and right sides of the river depends on the selected 'Flow direction' of the river. Refer to the Rivers definition description for more details.

The 'Z' column is the elevation of the points.

The 'Insert' button above the table can be used to insert a new line at the bottom of the table, while the 'Delete' button can be used to delete the active line.

Markers may be assigned to points under the 'Marker' column of the table. Markers can be assigned in two ways. Click an element under the 'Marker' column, which opens a marker dialog as shown in Figure 3.31 from which a marker number may be defined for the selected point.

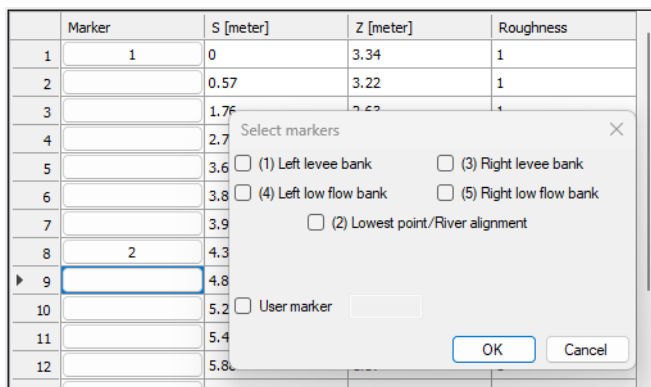

Figure 3.31 The Select Markers dialog

Alternatively, select a point on the cross section plot below the table, and press the marker number on the keyboard. Pressing the 'Ctrl' key and the marker number will remove the marker for the selected point on the cross section plot.

A number of markers may be defined:

- **Left and right levee banks (Markers 1 & 3):** Defines the extent or the active part of the cross section used for calculations. Default placement of markers 1 and 3 is to apply marker 1 in the very first point in the raw data and marker 3 at the very last point of the raw data. Placing any of these markers at different locations will limit the extent of the active part of the cross section such that only the part of the cross section between markers 1 and 3 is included in the simulation (that is, Processed data are only calculated for cross section data between these markers).
- **Left and right low flow banks (Markers 4 & 5):** Defines the extent of the low flow channel. The markers influence the calculation of the processed data. If defined, the section is internally divided into three major 'slices' at markers 4 and 5 positions and the resulting processed data for such a section is a sum of integration results of three sub-parts of the section instead of calculating a result from one single, large section.



Additionally, markers 4 and 5 can be used to define the extent of the low flow channel which is used with the 'High/low flow zones' description of the resistance distribution in the raw cross section data.

- **Lowest point/River alignment (Marker 2):** Marker 2 typically defines the lowest point of the river section, or the location of the intersection with the river line. Marker 2 settings do not affect the calculations. Instead, it is primarily used to place cross sections which have no coordinates defined along the river alignment. It is therefore recommended to define the correct position of marker 2 in all sections.
- **User marker:** Any number above 7 may be used as a user marker. User markers do not impact the simulation results. They are an option for indicating a specific point in a cross section e.g. the location of a measurement gauge.



**Note:** Marker locations must be defined such that marker 1 is defined to the left of marker 3 in the raw data table.

### Update Markers

This button automatically updates markers 1, 2 and 3 locations in the current cross section, which are at the left end point, lowest point, and right end point, respectively.

### Section Type

The type of cross section is set here. Four options are available:

- **Open section:** Typical setting for river cross sections.
- **Closed irregular:** Closed sections with arbitrary shape.
- **Closed circular:** Closed circular section shape where the geometry is only defined by the diameter.
- **Closed rectangular:** Closed rectangular section shape where the geometry is only defined by the width and height.

### Datum

A datum value may be entered here. The datum is normally used for adjusting the levels of the cross sections such that they conform to a specific reference datum in the model area. The datum value is added to all elevations in the 'Raw data' tab. The datum is also used for circular and rectangular sections to set the elevation of the bottom level of the cross section.

### Roughness Type

There are various options for defining the desired type of roughness method for cross sections. The following types are available:



- **Relative roughness:** The resistance/roughness is given relative to the roughness number specified in the 'Bed roughness' editor. The roughness value specified in the cross section for this roughness type is therefore a coefficient. A coefficient higher than 1 will increase the actual roughness of the river bed, whereas a coefficient lower than 1 will decrease the actual roughness. So when the roughness type is Manning (M) in the 'Bed roughness' editor, then the Manning's M value is divided by this coefficient. When the resistance type is Manning (n), then the Manning's n value is multiplied by this coefficient.
- **Manning's n:** The roughness number is specified as Manning's n in the unit  $s/m^{(1/3)}$ .
- **Manning's M:** The roughness number is specified as Manning's M in the unit  $m^{(1/3)}/s$  (Manning's  $M = 1/\text{Manning's } n$ ).
- **Chezy number:** The roughness number is specified as Chezy number in the unit  $m^{(1/2)}/s$ .
- **Darcy-Weisbach (k):** The roughness is specified in the form of an equivalent grain diameter.



**Note:** Roughness numbers have to be defined in the 'Bed roughness' editor, as a global value and eventually local values. However, if absolute roughness numbers are defined in one or more cross sections as either Manning's n, Manning's M or Chezy number, then these numbers will have first priority and overrule any roughness values defined in the 'Bed roughness' editor.

### Roughness Distribution

The distribution type defines the description of the transversal roughness across the cross section. Three options are available:

- **Uniform:** A single roughness number will be applied uniformly throughout the cross section.
- **High/Low flow zones:** Three roughness numbers are to be specified. The 'Left high flow' number applies between markers 1 and 4, the 'Right high flow' number applies between markers 5 and 3, and the 'Low flow' number between markers 4 and 5. If marker 4 and 5 do not exist the low flow roughness number will apply uniformly throughout the cross section.
- **Distributed:** The roughness number is to be specified for each point in the raw data table in the 'Roughness' column. The value specified for a given point applies uniformly between the point and the previous point.

### Sediment Transport Floodplain Level Definition

If the Sediment Transport module is active for river model simulations, this controls the level of the floodplain above which no sediment transport calculation is considered. Three options are available:

- **None (top of cross section):** The level is set to the highest level of the cross section, meaning that the sediment transport calculation is also performed in the floodplain when the cross section covers this floodplain.



- **Min. of markers 4 and 5:** The level is set to the lowest value between levels of markers 4 and 5.
- **User defined:** A user defined value is used. The level of the floodplain must be defined accordingly.

The floodplain level definition is only used when the Sediment Transport module is active for river model simulations and when it includes morphological updates.

## Processed Data

The ‘Processed data’ tab displays the hydraulic characteristics of the cross section which are used during the simulation (Figure 3.32). These processed data provide the values of cross section area, radius, width, bed roughness and conveyance as a function of the water level.

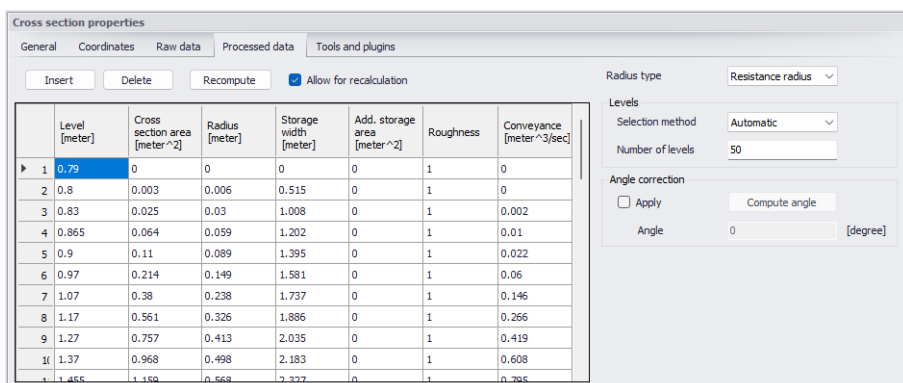

Figure 3.32 The Processed Data tab page on the Cross Section Properties panel

Details on these variables are given below:

- **Level:** Levels for which processed data are calculated in the cross section. Default level definitions range from the lowest z-value and up to the highest z-value in the raw data table.
- **Cross section area:** Effective cross sectional flow area calculated from the raw data. Effective area is determined from the total flow area adjusted by eventual relative resistance values different from 1 in the raw data tab.
- **Radius:** Resistance or hydraulic radius depending on the selected type in the ‘Radius type’ dropdown list.
- **Storage width:** Width of the water surface for the given water level.



- **Add. storage area:** Additional storage area defined manually as a function of the water level. The purpose of the additional storage area is to include an additional volume of storage in the cross section, which is not represented by the geometry in the raw data. The calculated water level in this additional storage remains strictly the same as in the cross section. This is useful for representing small storages associated with the main branch such as a lakes, bays and small inlets. The additional storage area values describe the area of the water surface for a given water level. Additional storage areas are always user-defined; they will never be given a value from the automatic processing of the raw data.
- **Roughness:** This factor can be used to apply a level dependent, variable roughness in the cross section. The roughness factor can contain the following two types of values depending on the Roughness Type definition in the raw data tab:
  - Roughness type defined as relative roughness factor: In this case, the roughness value is interpreted as a factor by which the roughness numbers defined in the 'Bed roughness' editor will be multiplied or divided during the calculation in order to establish a level-dependent roughness in the section. That is, the roughness factor works as a level dependent roughness scaling factor in the current section. It is important to note in the case of relative roughness type that a factor higher than 1 will increase the actual roughness of the river bed, whereas a factor lower than 1 will decrease the actual roughness. So when the roughness type is Manning (M), then the Manning's M value is divided by this factor. When the roughness type is Manning (n), then the Manning's n value is multiplied by this factor.
  - Roughness type defined as absolute roughness number (Manning's n, Manning's M or Chezy number): In this case, the roughness column contains the actual roughness number applied in the simulation. The roughness column can therefore have values of either Manning's M, Manning's n or Chezy numbers.
- **Conveyance:** Conveyance values are not used in the simulation but is primarily displayed as part of the processed data for the purposes of checking that the conveyance is monotonously increasing with increasing water level, which is one of the key assumptions for open water hydraulics.

During the simulation, the processed data will be interpolated in order to cover the full range of water levels encountered during the simulation.



**Note:** Processed data are essential in simulations as they describe the hydraulic properties for cross sections. Hence, it is important to inspect processed data and make sure that they accurately describe these hydraulic parameters. It is for example important to make sure that their plots are smooth in order to correctly reproduce progressive changes with changing water levels. If the plots show abrupt changes, it may be necessary to edit the





levels at which processed data are computed. Additionally, a situation where the conveyance column is not monotonically increasing with water levels can occur, especially in the case of some closed sections or in situations where the section geometry includes a sudden width increase and the radius type has been set to 'Hydraulic radius'. Should this occur, it is strongly recommended (not to say a strict requirement) to adjust the section characteristics such that a monotonically increasing conveyance curve is obtained. If not, there is a high risk of encountering instabilities in the simulation for water levels in the range where conveyance values are not monotonically increasing.

Typical options for optimising cross section characteristics for open sections is to use 'Resistance radius' types instead. Alternatively, when using the 'Hydraulic radius' type option, manually subdivide the section into several 'slices' by adjusting the relative roughness numbers in the raw data at locations where the section's shape significantly changes (e.g. changing a relative roughness value from 1.000 to 1.001 'forces' the processed data calculator to divide the integration of the processed data into several slices and the non-monotonically increasing conveyance curve can normally be resolved from this.



**Note:** The conveyance values presented in the conveyance column are actually not the 'True' conveyance values. Depending on the choice of roughness type in the 'Processed data' tab, the 'True' conveyance may depend on the roughness values specified in the 'Bed roughness' editor. However it has been decided to present conveyance values which do not consider these roughness numbers. Consequently, the conveyance shown in the processed data page does not reflect the true conveyance, but is primarily offered as a way for analysing the 'conveyance trend' as a function of water levels in the cross sections. These should be monotonically increasing with water levels to ensure healthy output from the simulations.

### Insert and Delete Buttons

The 'Insert' button above the table can be used to insert a new line in the table, while the 'Delete' button can be used to delete the active line.

### Allow for Recalculation

Processed data values may be automatically recomputed when this option is checked. Values are recomputed when changes are made to cross section properties, when the 'Recompute' button in the tab page is pressed, or when the 'Recompute all' or 'Recompute selected' buttons in the 'General' tab are pressed. In case the processed data have been manually adjusted, one may need to uncheck this option to ensure manual adjustments are unchanged.



**Note:** Processed data are also recomputed when the setup is saved if 'Allow for recalculation' is active.

### Recompute

This button is only active when the option 'Allow for recalculation' is checked. Pressing this button recomputes all the processed data in the table.



## Radius Type

The radius type may be set as:

- **Resistance radius:** A resistance radius formulation is used.
- **Effective area, hydraulic radius:** A hydraulic radius formulation where the area is adjusted to the effective area according to the relative roughness variation.
- **Total area, hydraulic radius:** A hydraulic radius formulation where the total area is equal to the physical cross sectional area.

## Levels

Options for dividing the cross section into levels for processed data computation are:

- **Automatic:** The levels are selected automatically. In case Radius Type is 'Resistance radius,' levels are selected according to variations in section flow width. For 'Total area, hydraulic radius' radius type, levels are selected according to variation in the section conveyance.
- **Equidistant:** The levels are selected with equidistant level difference determined from the 'Number of levels' specified.
- **User-defined:** The levels can be fully or partially user-defined. Define levels in the 'Levels for processed data' table accessed via the 'Edit levels' button. If the number of defined levels is less than required by the Number of Levels specification the remaining levels will be selected automatically.

Set the desired number of processed data levels via the 'Number of levels' parameter. The automatic level selection method may not use the full number of levels specified. This will occur when a smaller number of levels is sufficient to describe the variation of cross sectional parameters.

The 'Edit levels' button is only available if the level selection method is user-defined. The required levels are entered manually or pasted into the 'Levels for processed data' table (Figure 3.33).



Level
8.462
8.532
8.601
8.671
8.74
8.81
8.88
8.949
9.019
9.088

Figure 3.33 'Levels for processed data' table

### Angle Correction

An angle correction may optionally be applied to the cross section. The correction may be used for situations where the cross section profile is not perpendicular to the center line of the river. To activate the correction, the 'Apply' checkbox must be checked, and the angle must be manually specified.

The correction applied is simply a projection of the cross sectional profile on the normal to the thalweg of the river:

$$X_{cor} = X \cos \theta \tag{3.2}$$

where  $\theta$  is as shown in the figure below.

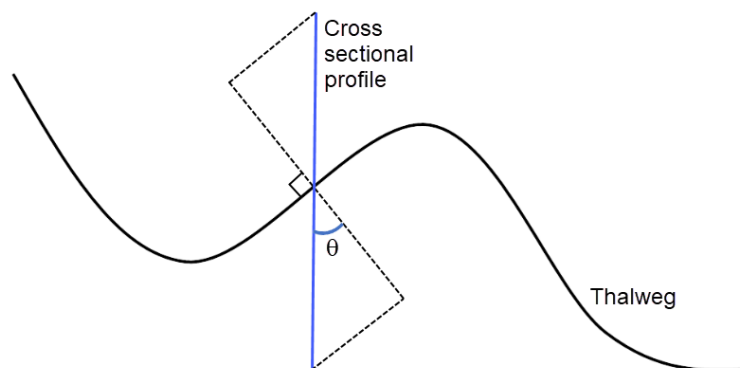

Figure 3.34 Correction angle for cross sections

Please note that the correction of X-coordinates is not reflected in a change of S values in the raw data table, but only in the processed data table.

## Cross Section Plot

The Cross Section Plot panel (Figure 3.35) shows various data:

- A single black line for the current cross section. The curve represents the values defined in the raw data table with the X axis describing the S values and the Y axis describing Z values plus the datum value.
- Points shown with red circles on the plot indicate the locations of markers 1, 2 and 3. Points shown with blue circles represent markers 4 and 5.
- The blue curve describes the resistance values across the current cross section.
- Optionally, a number of grey plots from different cross sections if the 'Draw history on plots' option in the 'General' tab is active.
- Optionally, a green line describing elevations obtained from a selected DEM, if the option 'Draw DEM elevations', in the 'General' tab, is active.

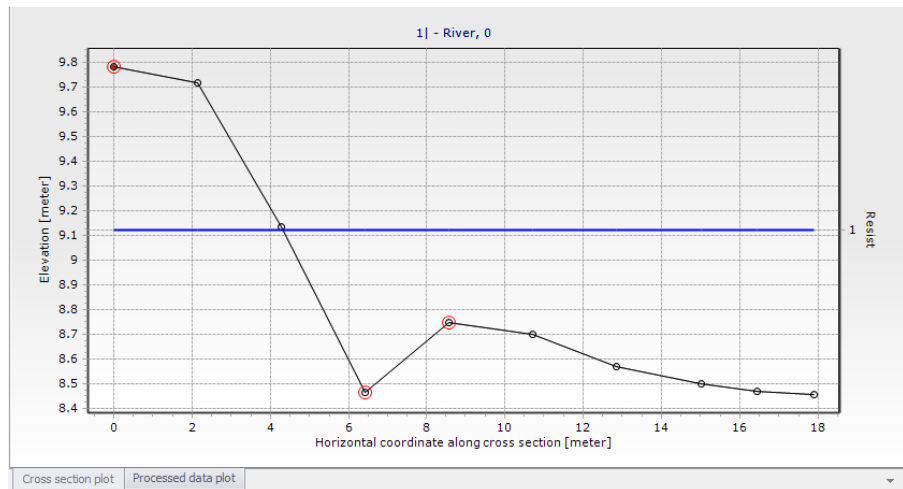

Figure 3.35 The Cross Section Plot panel on the Cross Sections editor



**Note:** To remove the history of cross section plots, right-click on the plot and choose 'Clear history' from the context menu (Figure 3.36).

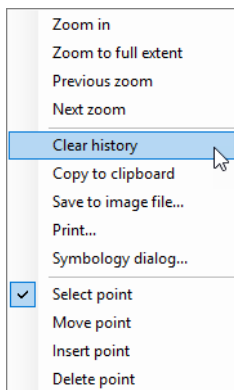

Figure 3.36 Context menu from the cross section plot

A number of options for the plot are available through the contextual menu. Right-click on the cross section plot to access the dialog (Figure 3.36).

The context menu includes the following three feature groups:

- The first group of features relates to zooming facilities: Zoom in, zoom to full extent, and previous/next zoom facilities are available.
- The second group of features relates to the appearance and export of the plot. From here you can export the image to the clipboard or to an image file on the disk, and you can also print it. Additionally, the symbology dialog allows changing the display settings of the plot.
- The third group of features relates editing the active cross section's raw data on the plot. The following functions are available:
  - Select: When active, it is possible to select a cross section point on the plot, which makes the point active in the raw data table. Pressing a number on the keyboard will assign the corresponding marker value to the selected point. Pressing the 'Ctrl' key + the number will remove the corresponding marker.
  - Move points: When active, it is possible to move a point graphically on the plot. The raw data table will be updated accordingly.
  - Insert: For adding new cross section points through the plot. Inserted points are interpolated between two existing points, and may be moved afterwards.
  - Delete: For deleting points from the plot.

## Processed Data Plot

The Processed Data Plot panel shows data for the current cross section, or also for a number of cross sections if the 'Draw history on plots' option in the 'General' tab is active (Figure 3.37).

The curve represents the values defined in the processed data table, with the Y axis describing the level values and the X axis describing one of the other

items from the table (e.g. area, radius, width, additional storage, roughness, or conveyance). The plotted item is controlled by the dropdown list above the plot.

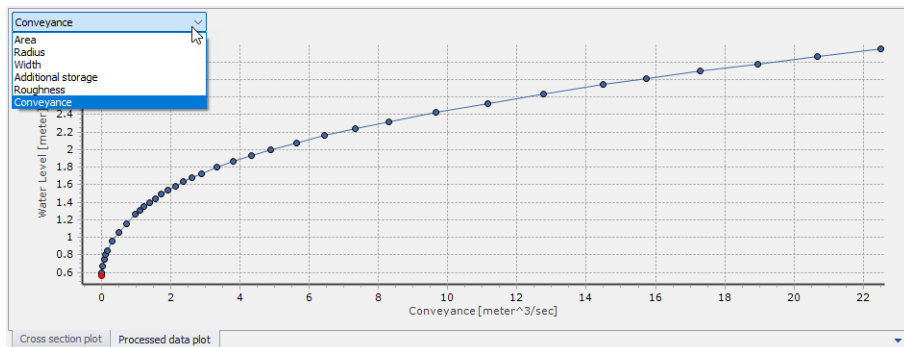

Figure 3.37 The Processed Data Plot panel on the Cross Sections editor

To control the settings and appearance of the plot, a number of options are available through a contextual menu. Open the menu dialog by right-clicking on the plot. Zooming and plot appearance options are offered on the context menu.

### 3.4.4 Tools and Plugins

The Tools and Plugins tab page in the Cross Sections editor offers several tools related to defining and processing cross section data (Figure 3.38).

Double-click on a tool name on the left panel to launch the tool.

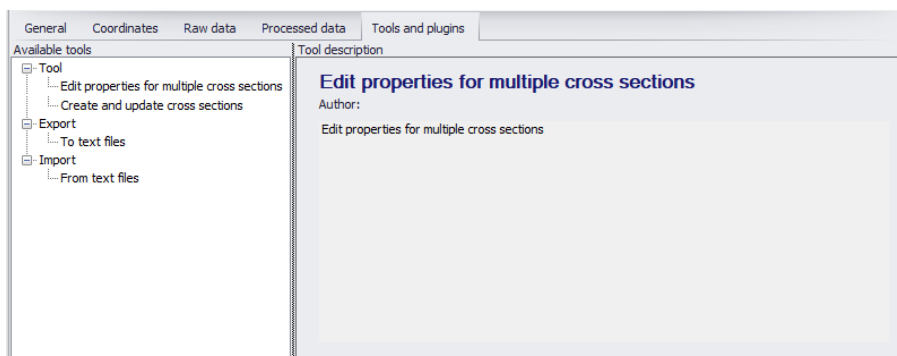

Figure 3.38 The Tools and Plugins tab page in the Cross Sections editor



## Edit Properties for Multiple Cross Sections

Use this tool to make multiple changes to raw and/or processed data for cross sections and apply them to multiple cross sections at the same time (Figure 3.39). To use the tool:

1. Select the parameters to edit from the Properties groupbox by ticking on the corresponding checkboxes for parameters of interest. The parameters are grouped into sections corresponding to their location (i.e. Raw Data, Processed Data, or Coordinates tab page).
2. Specify new values/settings for these parameters in the dialog.
3. Under the 'Apply to' groupbox, define for which cross sections the changes are applied from among the available options.
4. Click on the 'Update' button to run the tool. A status log for the tool execution is shown at the bottom of the dialog.

Figure 3.39 Dialog for the 'Edit properties for multiple cross sections' tool

### Raw and Processed Data

The following raw and processed data parameters may be modified with the tool:

- **Raw data - Datum:** The datum of the cross section can be changed here.



- **Raw data - Resistance:** A change of transversal distribution, resistance type definition and resistance values can be set here.
- **Raw data - Markers:** Multiple options are available to move markers. Markers 1 and 3 can be moved on river banks or to cross sections extents. Markers 4 and 5 can be moved to river banks. Marker 2 can be set either at the lowest point or at the intersection with the branch.

The tick-boxes in front of the maker values determine which markers should be updated as only selected marker values will be updated.

Additionally, when markers are moved to river banks, a minimum decrease of elevation must be specified to identify the location of the banks.

- **Processed data - Allow for recalculation:** The option 'Allow for recalculation' of the processed data can be activated or deactivated here.
- **Sediment transport - Floodplain level:** The floodplain level used in river model Sediment Transport calculations can be defined here. When it is set to User defined, the corresponding value must also be specified.
- **Processed data - Radius:** The radius type can be changed here.
- **Processed data - Levels:** The levels selection method, as well as the number of levels used for determining the processed data, can be changed here.
- **Processed data - Angle correction:** Activating or deactivating the angle correction respectively checks or unchecks the 'Apply' angle correction in the processed data.

Computing the angle correction edits the angle value.

## Location

Activating or deactivating the coordinates respectively checks or unchecks the 'Apply' option in the Coordinates tab.

Location

Activate coordinates

Invert left and right sides in: Coordinates and raw data

Invert only if coordinates are digitised from the right to the left side

Edit chainage or coordinates

Recompute chainage using  $\text{New Chainage} = a * \text{Original Chainage} + b$

a: 1 b: 0

Update chainage using coordinates and branch location

Reset coordinate using raw data, chainage and branch location

Inverting left and right sides of the cross section swaps either the coordinates of the cross sections, the raw data or both. The option 'Invert only if coordinates are digitised from the right to the left side' allows to perform this change only in case the cross section's coordinates have been provided in the wrong direction.





Several options are available to edit the chainages or coordinates:

- Recomputing the chainage with the formula  $\text{New Chainage} = a * \text{Original Chainage} + b$ , where a and b can be changed manually.
- Updating chainages of cross sections by using the cross sections coordinates and the position of the branch to identify their intersection. This may be used after moving a cross section on the map, to reflect the change in the chainage and therefore in the simulation.
- Resetting the coordinates: this will fill in the Coordinates table, assuming that the cross section is perpendicular to the branch and that marker 2 is aligned with the branch.

### Apply to

The selected changes can either be applied to all cross sections, or only to the selected ones.

Apply to

Apply changes to: All cross sections  Only update cross sections from branches and TopoID included in simulation

All cross sections  
Selected cross sections

If the option 'Only update cross sections from branches and TopoID included in simulation' is checked, all cross sections defined for non-existent branches, or under a different Topo ID than the one used for the branch in the simulation, are ignored.

### Buttons

- **Update:** Applies the selected changes to the cross sections.
- **Save log:** Saves the messages issued during the update to a text file.
- **Clear log:** Clears the log-messages in the text box above the buttons.
- **Close:** Closes the tool.

## Interpolate resistance

The tool 'Interpolate resistance' may be used to perform a linear interpolation of resistance values, and assign them to cross sections.

Note that the tool doesn't change the resistance distribution type for the cross sections, i.e. it may for example change the 'Uniform' value for a cross section which uses the type 'High / low flow zones' but in this case the cross section won't use the modified value in the simulation until its distribution type is changed.

### Option

It is possible to select between two different types of values to be interpolated:



- 'Uniform': this is used to change the 'Uniform' resistance value of the cross sections
- 'High/low flow zones': this is used to change the 'Left high flow', 'Low flow' and 'Right high flow' values of the cross sections.

The input resistance values to be interpolated are entered in the table. Each row contains a location (River ID and chainage) and resistance value(s). The locations specified in this table don't have to match the cross sections locations. When the cross sections are updated, values from this table are interpolated linearly as a function of the chainage, and are then assigned to cross sections found within the range of chainages defined between the smallest and the highest chainage specified for each river. When a cross section's chainage is out of the specified ranges, it is not processed.

Two buttons are available above the table:

- 'Import all sections': adds one row for each cross section's location existing in the model definition. Only the cross sections from the active Topo ID (Topo ID selected in the 'Rivers' editor) are imported.
- 'Import selected sections': adds only the cross sections being selected.

### Apply to

The selected changes can either be applied to all cross sections, or only to the selected ones. Regardless of the selected option, only the cross sections lying within the range of chainages specified in the table are updated.

If the option 'Only update cross sections from branches and Topo ID included in simulation' is checked, all cross sections defined on non-existing rivers, or on a different Topo ID than the one used for the river in the simulation, are ignored.

### Buttons

- Update: Applies the selected changes to the cross sections.
- Save log: Saves the messages issued during the update to a text file.
- Clear log: Clears the log-messages in the text box above the buttons.
- Close: Closes the tool.

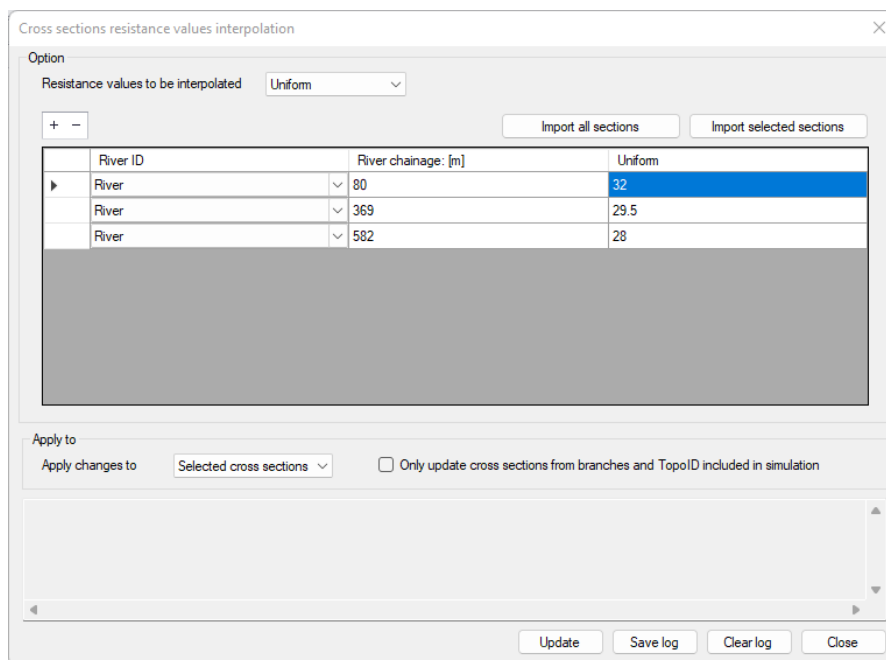

Figure 3.40 The resistance values interpolation tool

## Export to Text Files

This tool is used to export cross section data to a text file. Executing the tool opens a dialog, where one defines:

- The file name and path for the text file to be created. In this dialog, you can choose to export three types of data:
  - Raw data only: this will export most of the properties of the cross-sections (coordinates, elevation data and other properties)
  - Raw data and processed data: this will export the same data as with the option 'Raw data' as well as the table of processed data.
  - Marker levels and coordinates: this will not export the main properties of the cross sections, but only some specific selected information, including:
    - Levels at the various markers' locations
    - Minimum level from marker 1 and 3 (minimum levee level)
    - Minimum level from marker 4 and 5 (minimum low flow bank level)
    - XY coordinates at intersection with river (coordinates of the calculation point along the river)
    - XY coordinates at left or right end of cross section (coordinates of the first or last points of the cross sections, regardless of position of markers 1 and 3).
- Under the 'Apply to' groupbox, choose between exporting all cross sections or only currently selected cross sections.

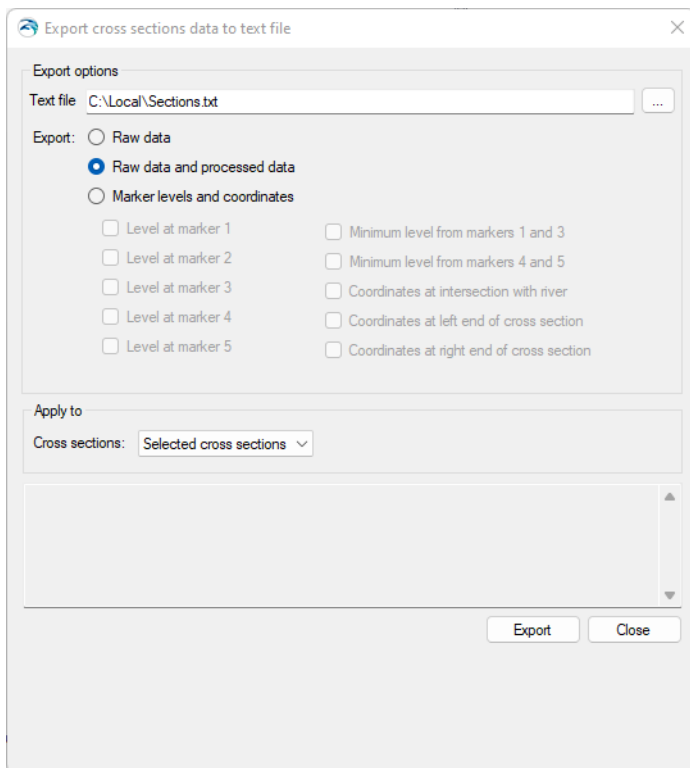

Figure 3.41 Dialog for the 'Export to text files' tool

### Import from Text Files

Use this tool to import cross section data from a text file. This facility reads raw topographical data as well as additional cross section properties for MIKE+.

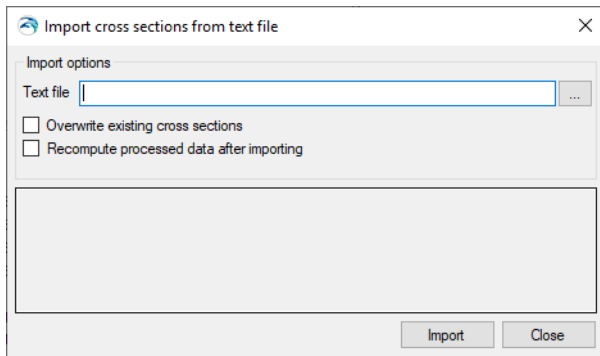

Figure 3.42 Dialog for the 'Import from text files' tool



Executing the tool opens a dialog (Figure 3.42,) where the text file to import should be defined.

This dialog also contains an option for overwriting existing cross sections when a cross section already exists at the location of an imported cross section. When this option is left unchecked, cross sections in the text file will not be imported when other cross sections already exist at the same location.

When 'Recompute processed data after importing' is selected, the table with processed data is automatically recomputed for each imported cross section.

### Text file format

As a minimum, each cross section must contain the following information, in this order:

```

Topo ID
Branch name
Chainage
    
```

In order to also import topographical data, a cross section needs a profile section, indicated by a 'PROFILE N' row, where N is the number of rows below containing the S-Z data.

Each cross section data must end with a row containing stars:

```

*****
    
```

There are no limits to the number of cross sections which can be imported from a text file.



An example text file for importing two cross sections is shown below:

```

Topo-Current
MainRiver
150
PROFILE 5
0 80.34
3.54 77.89
7.73 76.46
10.91 77.15
13.61 80.39
*****
Topo-Future
Tributary
0
PROFILE 6
    
```



```

0 75.16
2.15 74.89
3.52 73.21
5.69 73.36
8.46 73.54
11.94 74.79
*****

```

Note that columns can be space-delimited or tab-delimited. Any white space or tab at the beginning of a row will be ignored during the import process. All numerical values should be entered in international (SI) units.

Additional cross section properties may also be imported from the text file using additional and optional sections in the text file. Except for location information (Topo ID, Branch name and chainage) which must be the first sections for each cross section, all other sections can be added in any order in the text file for each cross section.

Usually, these additional sections consist of a first row identifying the river parameter, and one or more rows below with the corresponding values to be imported.



**Note** that it is possible to use the tool for exporting cross sections to get an example of a text file containing all properties that the importer can handle.

A list of possible additional properties is provided below:

- **PROFILE:** Additional columns can be added to the right of the S and Z columns to import distributed resistance numbers (third column) and markers (fourth column). Markers are identified with the following tags:
  - <#1> marker 1
  - <#2> marker 2
  - <#4> marker 3
  - <#8> marker 4
  - <#16> marker 5
  - <#32> marker 6
  - <#64> marker 7

When multiple markers are added to the same point of the cross section, the number to be inserted in the text file corresponds to the sum of numbers associated to these markers. For instance, <#6> will import markers 2 and 3 to the same point.

Additionally, the following data may be added:

- User marker in the fifth column



- X and Y coordinates for each point of the cross section in eighth and ninth columns respectively. Sixth and seventh columns are not used, and should be set to 0 for backward compatibility reasons in order to add coordinates. Note that when importing X and Y coordinates, it is important that specified S values are consistent with distances computed from these coordinates.
- **COORDINATES:** The line with numerical values first contains an indicator, which can be:
  - 0: The coordinates are not applied. In this case, no coordinates have to be specified afterwards.
  - 3: The coordinates are applied. In this case, this indicator is followed by another value on the same line, providing the number of sets of coordinates to be specified. Each set of coordinates is then provided as a separate line below, containing successively S, X, and Y values.
- **CLOSED SECTION:** This section can be added to import the cross section as a closed section. In this case, a value of 1 has to be added in the row below.
- **PROTECT DATA:** When this parameter is set to 0, the 'Allow for recalculation' checkbox is checked. It is unchecked for a value of 1.
- **DATUM:** Datum value for the cross section in meters.
- **RADIUS TYPE:** Numerical code indicating the radius type for the cross section, which can be:
  - 0: Resistance radius
  - 1: Hydraulic radius using effective area
  - 2: Hydraulic radius using total area.

When this section is not inserted, the default option (Resistance radius) is applied, except for closed sections, where the default is 2.

- **SECTION ID:** Optional identifier for the cross section.
- **INTERPOLATED:** The 'Interpolated' flag indicated by a star in the cross sections tree. It is set either to 0 (Not interpolated) or 1 (Interpolated)
- **ANGLE:** The correction angle used in the processed data. It is followed by a line with two numerical values:
  - The angle value
  - A value 0 when the angle correction is not applied, or 1 when applied.
- **RESISTANCE NUMBERS:** This section contains seven numerical values, as described and in the order below:
  - Transversal distribution, with a value of 0 for Uniform, 1 for High/low flow zones, and 2 for Distributed



- Resistance type, with a value of 0 for Relative, 1 for Manning n, 2 for Manning M, 3 for Chezy, and 4 for Darcy-Weisbach
  - Uniform resistance value
  - Resistance value for left high flow zone
  - Resistance value for low flow zone
  - Resistance value for right high flow zone
  - Resistance value for a vegetation zone
- **PROCESSED DATA:** Processed data for cross sections may also be imported in case it is not desired to use values recomputed by the program. The next two lines are text lines containing headings. Each row of the processed data table is then added as a separate line below, and with the following columns (in this order):
    - Level
    - Cross section area
    - Hydraulic radius
    - Width
    - Additional flooded area
    - Resistance factor

## Create and Update Cross Sections

The 'Create and update cross sections' tool offers possibilities for creating and modifying cross sections data. Launching the tool brings up a tabbed dialog (Figure 3.43), with various tab pages offering options that are relevant depending on the Method selected in the Method tab page.

To use the tool:

1. Choose the process to run on the **Method** tab page.
2. Configure settings in the data tab pages relevant for the selected method. For example, a method involving the use of DEM data will need configuration of parameters in the DEM Settings tab page.
3. Define where/for which river model elements (i.e. branch or cross sections) updates are made in the **Input Selection** tab page.



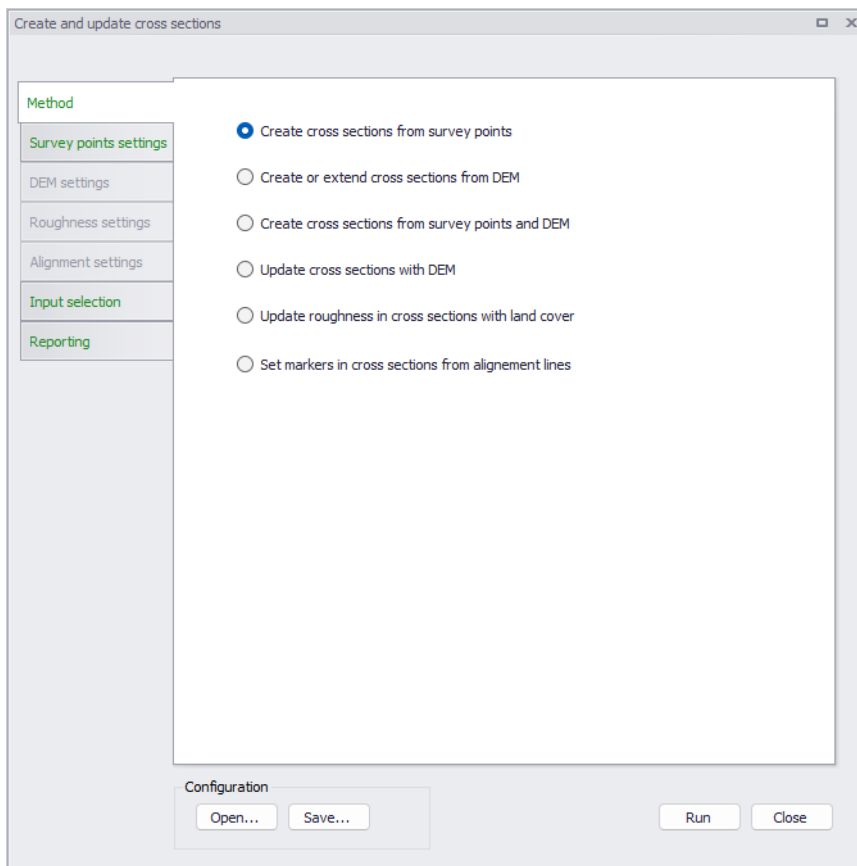

Figure 3.43 The dialog for the 'Create and update cross sections' tool

### Method

Choose the desired operation to run from the Method tab page. The Method tab page offers options to:

- **Create cross sections from survey points:** Option to define and extract cross section elevations from survey points.
- **Create or extend cross sections from DEM:** Option to create or add to cross section elevations data from a Digital Elevation Model (DEM).
- **Create cross sections from survey points and DEM:** Option to define and extract cross section elevations from both DEM and survey point data.
- **Update cross sections with DEM:** Option to modify cross section elevations from a Digital Elevation Model (DEM).
- **Update roughness in cross sections with land cover:** Option to modify/define cross section roughness from polygon feature layers/shapefiles, DFS2 rasters, or ASCII raster layers.



Cross section properties

General Coordinates Raw data Processed data Tools and plugins

+ - Update markers

	Marker	S	Z	Resistance
▶ 1	1	0	5.758	1
2		2	5.678	1
3		4	5.57	1
4		6	5.436	1
5		8	5.244	1
6		10	4.936	1
7		12	4.471	1
8		14	3.82	1
9		16	2.992	1
10		18	2.124	1
11	2	20	1.793	1
12		22	2.451	1
13		24	2.988	1
14		26	3.183	1
15		28	3.507	1
16		30	3.73	1
17		32	3.89	1

- **Set markers in cross sections from alignment lines:** Option to update the position of markers in cross sections, at intersections with alignment lines (polyline shape files, describing e.g. river bank locations). This operation will not alter the geometry of cross sections, but only update the marker positions according to the alignment line locations.

### Survey Points Settings

Define parameters in the Survey Points Settings tab page if the selected option from the Method tab involves use of survey points data.

Point feature layers (i.e. point shapefiles and \*.XYZ text files) loaded into the MIKE+ project may be used as survey point data.



Figure 3.44 The Survey Points Settings tab page

- **Survey points layer:** Select the pre-loaded feature layer (i.e. point \*.XYZ or shapefile) to use as survey points data from the dropdown list. An external point layer file may also be loaded using the ellipsis button.  
 Data formats in \*.XYZ files should be:
  - One row per point without header
  - 3 mandatory columns in the order: X, Y and Z
  - A fourth optional column with ID of the cross section to which the point belongs
  - Both space and tab are accepted as column separators
  - Both point and comma are accepted as decimal separators
- **Elevation attribute:** Select which numerical attribute in the chosen survey points layer represents elevation. This option is disabled for \*.XYZ files.
- **Gathering points in cross sections:** Define which survey points are used in creating cross sections:
  - Automatically using cross section ID attribute: With this options, the tool processes all points in one go. The survey point shapefile contains information on cross section IDs. Select the attribute in the shapefile that relates the individual survey points to a specific cross section from the dropdown menu. All survey points with the same ID field will be created as one cross section.

- Manually by selecting points in digitised polygon: For this option, the cross sections are created one by one. Use survey points within a polygon defined on the Main Map using the 'Digitize' button. Double-clicking on the Map ends the polygon creation, and a cross section is created using all the points from the layer in the digitised polygon.

The cross section is created as a straight line through the connected survey points using a least-squares fit. The individual survey points are projected orthogonally onto the cross section line as shown below in Figure 3.45.

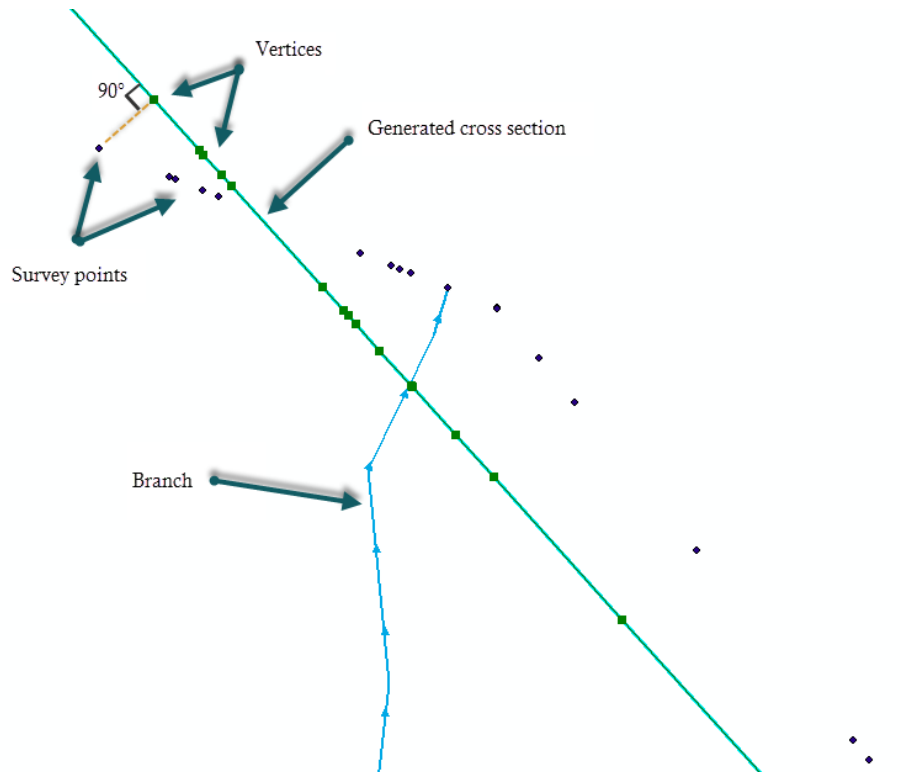

Figure 3.45 Survey points projected onto cross section line

### DEM Settings

Define parameters in the DEM Settings tab page if the selected option from the Method tab involves the use of DEM data (i.e. in creating or updating cross sections).



Figure 3.46 Options in the DEM Settings tab page

The following settings may be configured:

- **DEM layer:** Select or define the DEM raster layer to use in the processing. A pre-loaded raster layer may be selected from the dropdown list, or an external raster file may be loaded using the ellipsis button. Valid rasters include ESRI ASCII, DFS2 files, GeoTIFF files, and ESRI binary grids.
- **Maximum spacing between points:** The maximum spacing between points along the cross sections can either be user-specified or set per default to half the cell size of the DEM. The selected spacing between points is kept only if the created number of points remains lower than the specified maximum number of points. If this maximum number of points is reached, the spacing between points is increased accordingly.



- **Maximum number of points:** Should the specified maximum spacing between cross section points result in more than the allowed maximum points, the spacing is increased to obtain the maximum number of points. The maximum number of points is always the total number of points in the cross section: when extending existing cross sections, it also includes the number of points in the original cross sections.
- **Use bilinear interpolation from 4 closest cells:** When active, bilinear interpolation is used when extracting cross section z-values from the DEM cells. If unchecked the z-value in the cross section profile will be the exact value from the DEM cells that are intersected, whereas if bilinear interpolation is used, z-values will be the interpolated z-value from the 4 closest neighbouring DEM grid cells.
- **Create new with constant lengths:** Defining properties for new cross sections to be generated.
  - Interval: Equidistant distance between cross sections to be generated.
  - Width: This defines the width of the generated cross sections. Cross section lines will be located with half of the width distance on each side of the river centre line.

- **Create new at locations from layer:** Use a shapefile containing cross section polylines at the requested locations along the rivers in the model. Select the shapefile to use from the dropdown list of available shapefiles or load a shapefile using the ellipsis button.

Cross sections will only be generated where shapefile geometries intersect with the selected river branch. The cross section will be generated as a straight line from the first to the last point in the line shape.

It is possible to automatically assign an ID to each generated cross section by activating the option 'Assign ID from attribute'. This ID is obtained from the shapefile attribute selected in the dropdown list.

- **Extend existing with fixed width on both sides of rivers:** Widen cross sections on both sides of rivers as much as the length specified in the input box. Topography along the extended parts of cross sections is obtained from the underlying DEM.
- **Extend existing up to alignment lines:** Use alignment lines to extend the width of existing cross sections. Topography along the extended parts of cross sections is obtained from the underlying DEM.
- **Manually digitize on map:** Create a cross section along a line defined interactively on the Map. Cross sections will only be generated if they intersect a river. Click the 'Digitize' button to draw cross sections locations on the map. Double-click to stop digitizing a cross section, before digitizing additional locations if necessary. Right-click when all locations are digitized, to create the cross sections.



Creating cross sections requires that 'Elevation and Spacing' options are defined. This requires that a DEM is selected, and that the spacing between points as well as the maximum number of points are specified. When extending a cross section, the specified maximum number of points corresponds to the total number of points in the extended cross section, including original points.

If a cross section intersects with more than one alignment line of the same type, the alignment line closest to the river is used.

### Roughness Settings

Configure parameters in the Roughness Settings tab page when using the 'Update roughness in cross sections with land cover' option.

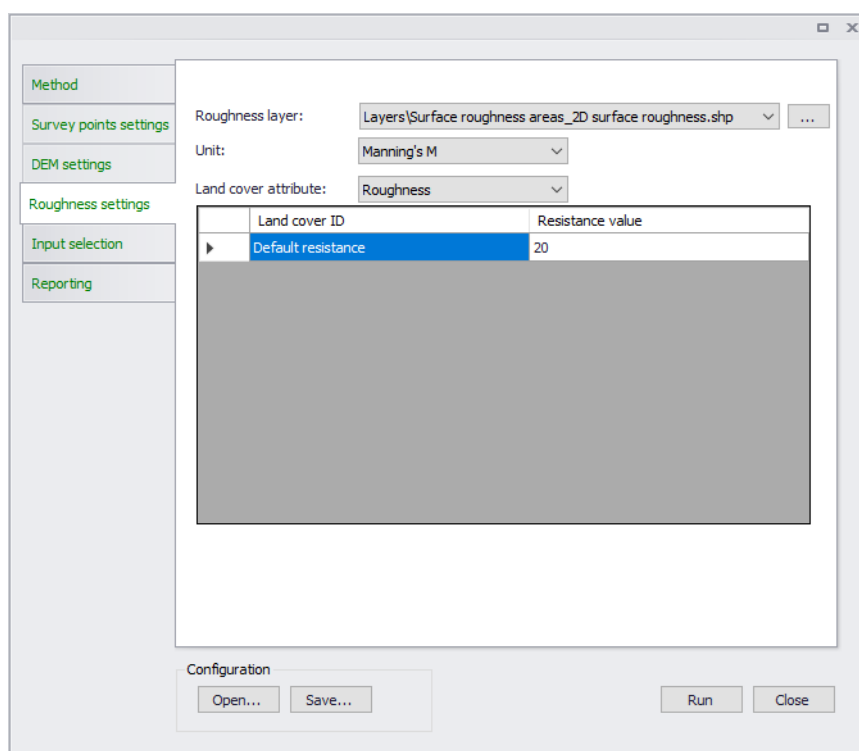
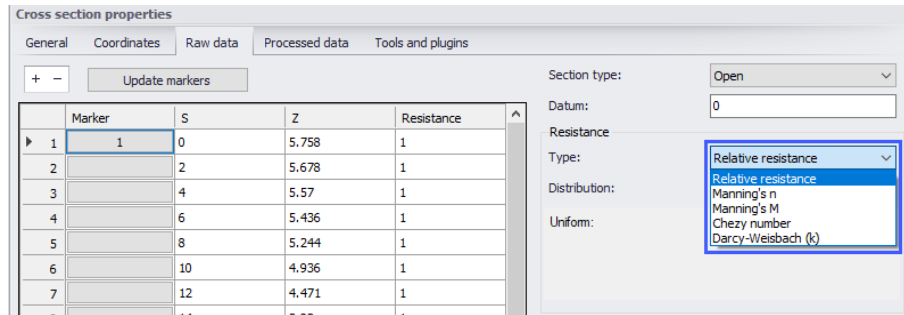

Figure 3.47 The Roughness Settings tab page

- **Roughness layer:** Select or load the raster or polygon feature layer to use in the processing. Select valid pre-loaded shapefiles or rasters from the dropdown list, or point to external files using the ellipsis button.
  - Polygon feature layer: Selecting a polygon feature layer requires further definition of feature attributes and corresponding resistance values.
  - Raster layer: Values as defined in the raster layer are used as resistance values in the processing.



- **Unit:** Defines the Resistance Type for the values being defined (see Cross Sections Raw Data):
  - Relative resistance
  - Manning's n
  - Manning's M
  - Chezy number
  - Darcy-Weisbach (k)



- **Land cover attribute:** If the Roughness Layer is a polygon feature/shapfile layer, define the feature attribute representing Resistance values from the dropdown list. Attributes with integer values can be used.

The secondary table lists unique resistance attribute types from the feature layer. The first row shows uneditable information for 'Default resistance' used for areas not covered by features in the layer. Define corresponding resistance values for each attribute type.

### Alignment settings

This tab is used to control how cross sections markers are to be updated, when using the method 'Set markers in cross sections from alignment lines'.



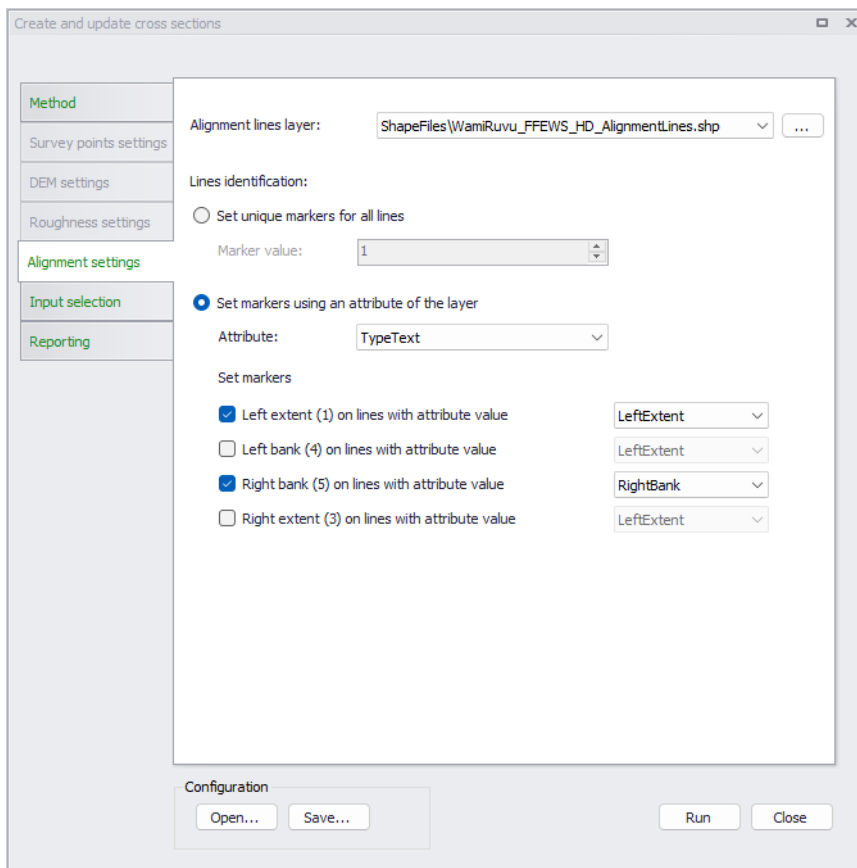

Figure 3.48 Options in the Alignment settings tab page

This operation will not alter the geometry of cross sections, but only update the marker positions according to the alignment line locations. If the cross section does not contain a point at the marker position a new point is inserted with an elevation interpolated from the previous and next point in the cross section. If a cross section does not intersect with an alignment line, the marker is not updated. If a cross section intersects with more than one alignment line of the same type, the alignment line closest to the branch is used.

Select or define the alignment line shape file in the 'Alignment lines layer' list. A pre-loaded layer may be selected from the dropdown list, or an external shape file may be added using the ellipsis button. Only shape files containing polylines are valid for this tool.

Two different options are available to set markers at intersections with the polylines in the shape file:



- Set unique markers for all lines: with this method, the same marker value will be applied at all intersections between the processed cross sections and any alignment line. The applied marker value must be specified in the 'Marker value' field. This method can apply any marker value to the cross sections, although only values from 1 to 5 are used by MIKE+ (higher values will be used as user-defined marker).
- Set markers using an attribute of the layer: with this method, the value to be applied will be read from an attribute of the selected shape file. It therefore allows to process different markers with the same shape file. When using this method, the following settings are used:
  - Attribute: this list shows all attributes in the selected shape file. Select the attribute defining the marker value to be updated. The attribute can contain either a numerical value or a text.
  - Set markers: this method can update the position of markers 1, 4, 5, and/or 3. Tick the markers to be updated using the available boxes. For each selected marker, select the corresponding value in the shape file's attribute. The given marker will be set at the intersection with an alignment line, only if the line's attribute contains the selected value.

### Input Selection

Define which parts of the river model are involved in the processing in the Input Selection tab page.

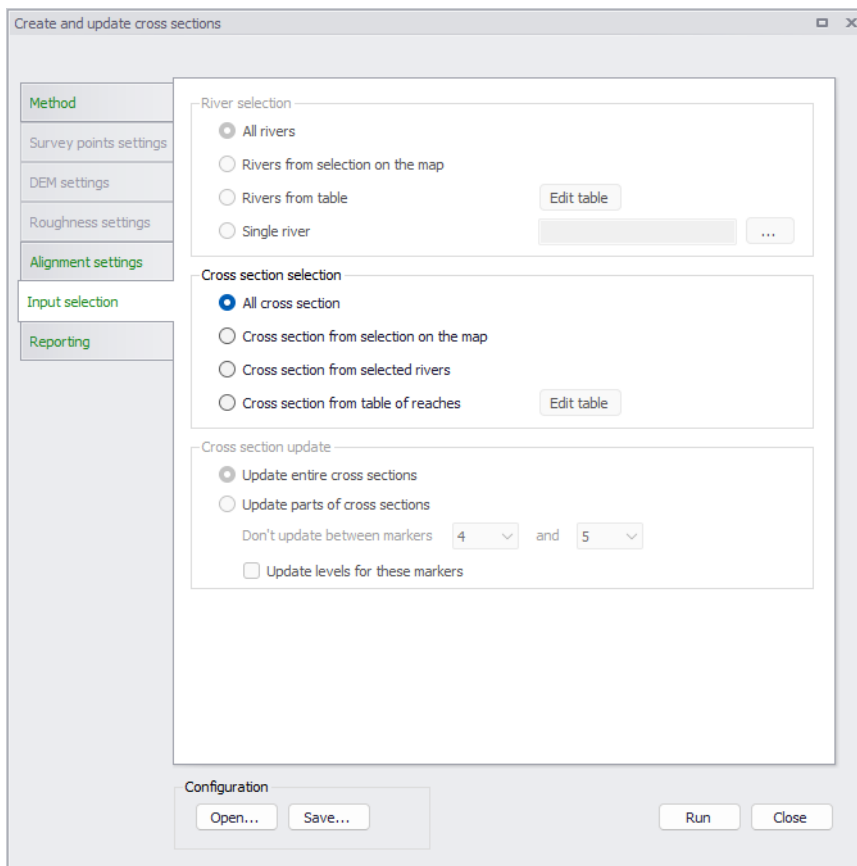

Figure 3.49 Options in the Input Selection tab page

The tab page presents options for selecting river branches and reaches to involve in the processing as appropriate for some methods. It also has options for selecting cross sections, or parts of cross sections, relevant for other methods.

- **Rivers selections:**
  - All rivers
  - Rivers from selection on the map
  - Table of reaches: The reaches are defined using the 'Edit table' button.
  - Single river: Define the river in the input box.
- **Cross sections selections:** Relevant for selecting the cross sections to process.
  - All cross sections: All cross sections in the model will be updated.
  - Cross sections from selection on the map: Only the selected cross sections will be updated.



- Cross sections from selected rivers: Only the cross sections on the selected river branches will be updated.
- Cross sections from table of reaches: The reaches are defined using the 'Edit table' button. The locations of cross sections to be updated are specified in a table, offering flexible options to control the branches to be included, and also the range of chainages for each branch where cross sections are updated. Cross sections are updated only between the specified lowest and highest chainages, and if the box is checked in the 'Include' column.

The 'Edit table' buttons present a dialog wherein river branches and reaches to include in the processing may be easily defined in a list.

	Include	Channel ID	Upstream ch.	Downstream ch.	
▶	<input checked="" type="checkbox"/>	River	742	1410	Insert
					Delete
					Import all
					Import from file
					Include all
					Exclude all

- **Cross sections update:** Relevant for selecting which **parts** of (selected) cross sections to process.
  - Update entire cross sections: This updates the elevation data all along the cross sections.
  - Update parts of cross sections: For updating only parts of cross sections.

Use the 'Don't update between markers' option to define segments along cross sections to exclude from editing based on marker values.

Tick the 'Update levels for these markers' option to allow levels of the selected markers to be updated/adjusted. Levels at the selected markers are unchanged if the option is unchecked.



Update whole cross sections  
 Update parts of cross sections  
 Don't update between markers  and   
 Update levels for these markers

As an example, it is possible to update the elevation data only in the floodplain by use of markers 4 and 5, which may be located on the banks. If banks levels are obtained from a survey which is assumed to be more accurate than the DEM used to update the floodplain, then the option should remain unchecked in order not to update the bank levels. On the opposite, if the new DEM is assumed to be more accurate than original data describing the banks, the option should be checked to update the bank levels as well.

### Reporting

The Reporting tab page shows information about the tool execution. Use the 'Save report' option to generate a file copy of the execution log. The 'Clear report' button clears the contents of the execution log shown in the dialog.

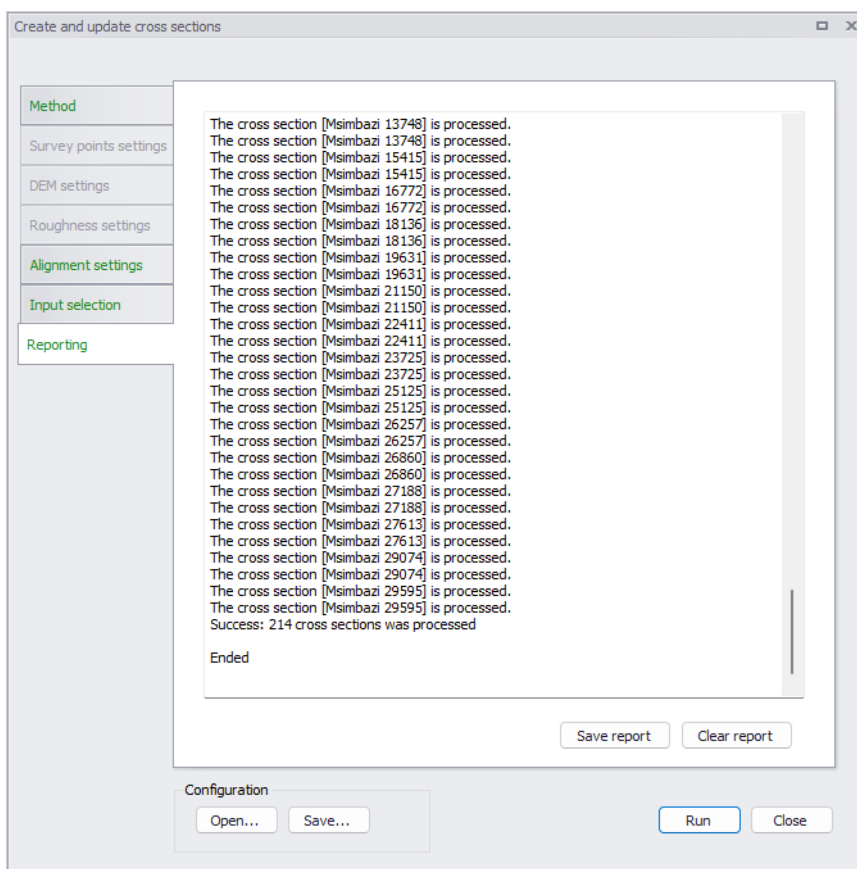

Figure 3.50 The Reporting tab page



## Buttons

- **Run:** Generates or updates cross sections following the specifications in the dialog.
- **Digitize:** Used to define the polygon for manually selecting the survey points to use. Also executes the tool after defining the polygon.
- **Open:** Loads a previously-saved \*.XML configuration file for the tool.
- **Save:** Saves the tool configuration to an \*.XML file.
- **Close:** Closes the tool.

## 3.5 Bed Roughness

Bed roughness values for hydrodynamic computations may be defined for river networks in MIKE+.

ID	River ID	Chainage [m]	Roughness [m <sup>1/3</sup> /s]	
1	Roughness_21	VIDAA-MAG	53	25
2	Roughness_22	VIDAA-OVR	4822	23
3	Roughness_23	GRONAA-TM	1601	18
4	Roughness_24	GRONAA-TM	7450	20
5	Roughness_25	SONDERAA	0	32
6	Roughness_26	SONDERAA	3700	31

Figure 3.51 The Bed Roughness editor for river networks in MIKE+

## Roughness Definition Type

### Distribution

Two approaches may be applied for the bed roughness definition. Either a single (uniform) elevation zone or a so-called multiple zones approach.

With the 'Single elevation zone' option, bed roughness is applied using a uniform section approach. The bed roughness is defined by the selected rough-



ness 'Formulation' and associated default (global) and local values if the 'Resistance type' has been set to 'Relative resistance' for the cross section. The resulting roughness number applied in the simulation is the defined bed roughness multiplied by the water level-dependent 'Resistance factor' which is specified for the cross sections in the cross section editor (saved in the \*.XNS11 file).

With the 'Multiple zones' approach, the same rules apply, but it also offers a possibility for the user to divide the cross sections in a number of zones with different global/local bed roughness values. These zones would typically represent the various areas with a local bed roughness value (e.g. a zone without vegetation at the bottom of the cross section, a vegetation zone on banks, etc.) as illustrated in Figure 3.52.

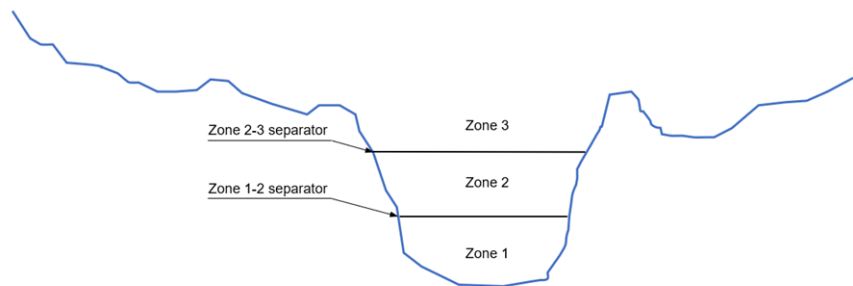

Figure 3.52 Multiple zones description of a cross-section

The resulting bed roughness numbers applied in the simulation are the zone values multiplied by the 'Resistance factors' specified for the cross sections in the cross sections editor.

Zones separators, defining the threshold level or depth between two consecutive zones, must be specified in the 'Zones separators' tab.

During the simulation, the bed roughness applied to the cross section will vary in time as a function of the water level: at each time step, the bed roughness from the zone in which the water surface is, will apply uniformly to the whole cross section.

### Formulation

Four bed roughness formulations are available from the Formulation dropdown menu:

- Manning (M) (Unit:  $m^{1/3}/s$ ; Typical range: 10-100)
- Manning (n) (Reciprocal of Manning M; Typical range: 0.010-0.100)
- Chezy (C) (Unit:  $m^{1/2}/s$ )
- Darcy-Weisbach (k) (Unit: m)



For more information on the resistance formulas, please refer to the MIKE 1D Reference Manual.

The selected Formulation type will apply to both global and local roughness definitions, and no matter if the definition is based on a single zone or multiple zones.



**Note:** Bed roughness values are actually applied to processed data of the cross section. Each row from the processed data table gets the bed roughness value from the zone corresponding to the row's level. Interpolation will apply afterwards during the simulation, between the processed data levels.

## Roughness values

Roughness numbers specified in this editor are a combination of a default roughness value and possibly one or more 'Local roughness' values.

The 'Default roughness' value represents a global bed roughness value. It is applied for all calculation points in the river network, unless local values are defined. For the 'Single elevation zone' approach, a uniform value needs to be specified. For the 'Multiple zones' approach, a default 'Number of zones' must be specified, which is applied to all calculation points of the river network unless local bed roughness values with a different number of zones is specified. The default bed roughness values for each of the default zones must also be specified.

Local roughness values are applied at specific locations defined by River ID and chainage. Add local roughness values through the editor using the 'Insert' button. Each local value is defined with:

- **ID:** Unique ID for the local roughness definition
- **River ID:** River branch ID
- **Chainage:** Location along the river branch for the local roughness definition

For the 'Single elevation zone' approach, a uniform roughness value for the location has to be specified in the 'Roughness' field. For the 'Multiple zones' approach, a local number of zones and their corresponding roughness values must be specified. The roughness values for the local zones are specified in the overview table at the bottom of the editor. This local number of zones can only apply if corresponding local zones separators also exist on the same reaches of rivers. Therefore, if a local bed roughness location is added, but if no local zone separators exist, the local bed roughness is defined with the global number of zones.

If two or more local values are defined on the same river, intermediate values are calculated by linear interpolation.





Bed roughness

Roughness definition type

Distribution  Single elevation zone  Multiple zones Formulation Manning (M)

Roughness values Zone separators Roughness factors

Default roughness

Number of zones 2

Zone 1 29 [m<sup>1/3</sup>/s] 2 24

Local roughness

Number of zones 4

ID Roughness\_26

River ID SONDERAA Chainage 3700 [m]

Insert Delete

ID	River ID	Chainage [m]	Zone 1 (lowest) [m <sup>1/3</sup> /s]	Zone 2 [m <sup>1/3</sup> /s]	Zone 3 [m <sup>1/3</sup> /s]	Zone 4 [m <sup>1/3</sup> /s]
1	Roughness_21	VIDAA-MAG	53	25	19	30
2	Roughness_22	VIDAA-OVR	4822	28	25	30
3	Roughness_23	GRONAA-TM	1601	21	18	30
4	Roughness_24	GRONAA-TM	7450	23	20	30

Figure 3.53 The Bed Roughness editor with the Multiple zones definition type

## Zone separators

Zone separators define the vertical threshold elevation between two consecutive zones, when the 'Multiple zones' approach is applied.

The default zones separators are applied throughout all calculation points in the network, unless local zones separators have been defined. Zones separators' values may either be expressed as depths or levels. When expressed as depth, the specified depths represent the height from the bottom of the cross section up to the zone separators. Depths for the consecutive zone values must therefore increase.

Local zones separators must be specified at locations where a local number of zones is expected, or at locations where the zones need to have different elevations than the default values. Local zone separators are added using the 'Insert' button, and are located by a River ID and a chainage. For each location, the various thresholds between zones are specified in the overview table at the bottom of the editor.

ID	River ID	Chainage [m]	Zones separators defined as	Zone 1-2	
1	ZoneSeparator_1	LINDSKOV	3314.308	Depth	1.2
2	ZoneSeparator_2	VIDAA-MAG	5900	Depth	1.4

Figure 3.54 Definition of zone separators for the bed roughness definition with Multiple zones

## Roughness factors

By activating the 'Apply bed roughness factors' option, it is possible to apply factors/coefficients to the bed roughness values, which can either be constant or varying in time. This facility e.g. allows to apply seasonal variations of bed roughness.

Applying a roughness factor higher than 1 will decrease the actual roughness of the river bed, whereas a value lower than 1 will increase the actual roughness. So, when the roughness type is Manning (M), then the Manning (M) value is multiplied by the factor. When the roughness type is Manning (n), then the Manning (n) value is divided by the factor. This applies regardless if the cross sections use a relative or Manning roughness value: if a cross section uses a Manning roughness value, then the roughness factor is applied to its processed data.

Roughness factors specified in this editor are a combination of a default (global) value and possibly one or more local factors.

The default roughness factor is applied throughout all calculation points in the river network, unless local values have been defined.

Local roughness factors are applied at specific locations defined by River ID, start chainage and end chainage.

## 3.6 Structures

Consideration of man-made interventions and hydraulic structures is important in most river applications to achieve accurate and reliable model results. Hydraulic structures impose significant internal control points to a river model



allowing for correct flow dynamics and back water effects around structures in the model.

MIKE+ supports the modelling of the following types of river network structures:

- Culverts
- Weirs
- Bridges
- Pumps
- Gates
- Direct discharges
- Dambreak
- Energy losses
- Tabulated structures

Structures are placed at Q-points where the momentum equation is solved, and structures are included in a model to replace the momentum equation with something more suitable for the structure in question. The effect of the bed friction is generally not taken into account, and thus there must be h-points (cross sections) up- and downstream close to the structure.

Insert a structure in the river model through the main Map. Use the Create tool from the Edit Features toolbox on the River Network menu ribbon to define structures on the Map.

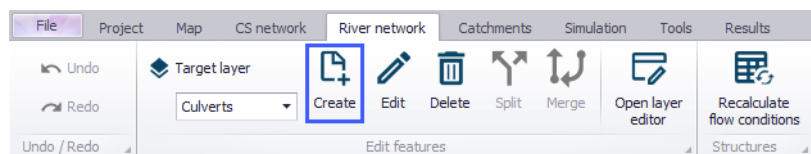

Figure 3.55 Define river structures on the Map using the Create tool on the River Network menu ribbon.

Set the target layer to the expected structure type, and use the Create tool to define a structure on the Map. Click along a river branch to locate the structure.

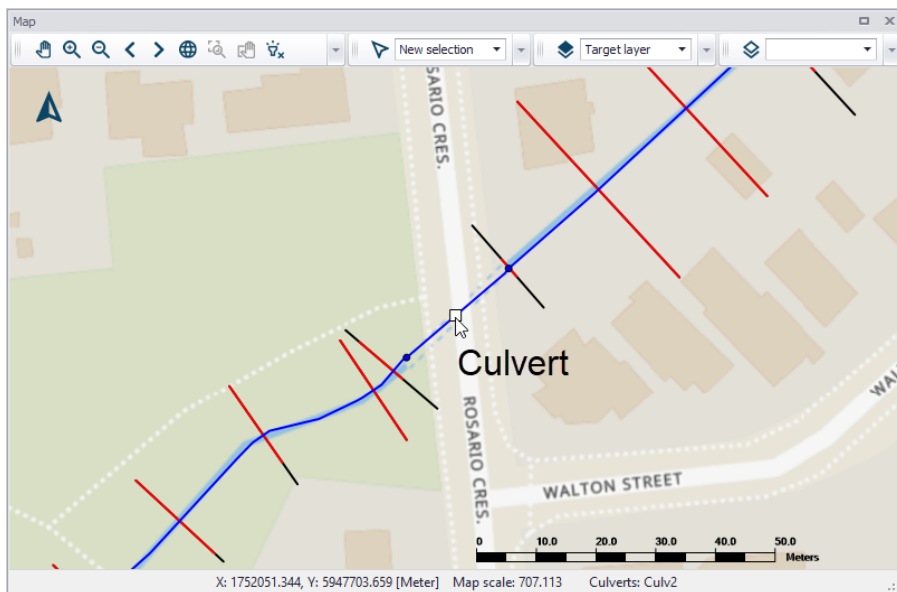

Figure 3.56 A culvert defined along a river network in MIKE+

Records for structures defined on the Map are added in the corresponding editors. Also, structures may be defined directly in the editors using the 'Insert' button. Use the 'Delete' button in the editor to remove a structure from the river model.

### 3.6.1 Culverts

Culverts are structures that allow flows from one point to another through obstructions, such as roadways. Data on culverts are contained in the Culverts editor (Figure 3.57).

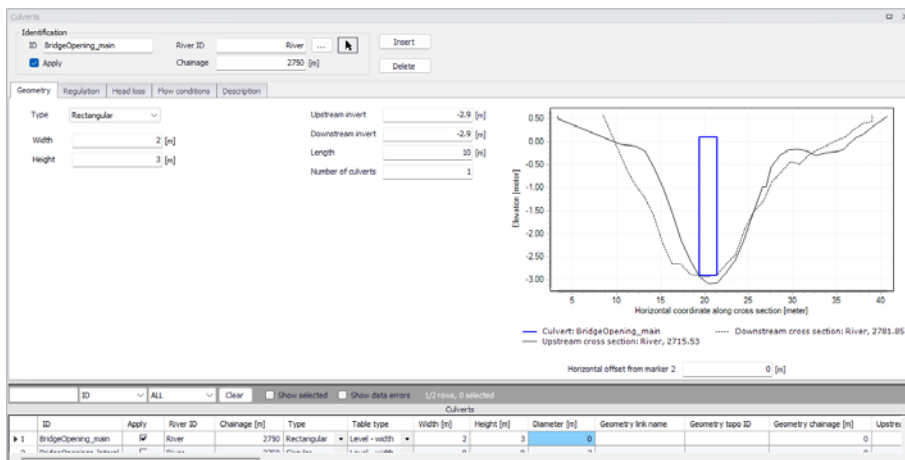

Figure 3.57 The Culverts editor accessed via the River Network setup group

## Identification

The Identification group holds basic information on culverts.

### ID

Unique string identification for the culvert.

### River ID

The ID of the river branch where the culvert is located. The River ID is automatically registered is the culvert is defined via the Map. Use the button with an arrow, to select the location of the structure on the map: this will specify both the River ID and the Chainage of the structure.

### Chainage

Chainage at which the culvert is located.

### Apply

This check box allows the user to toggle the Active status of the culvert on and off. The simulations will omit all culverts that are not active.

## Geometry

Geometric properties for the culvert are defined on the Geometry tab page of the Culverts editor (Figure 3.58).

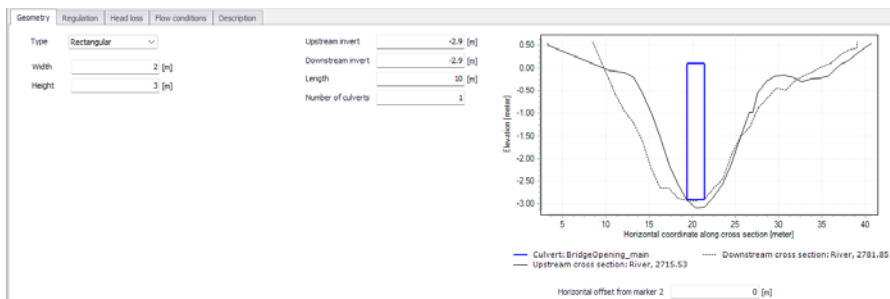

Figure 3.58 Geometry tab on the Culverts editor

Define properties such as:

### Type

The type of cross sectional geometry for a culvert:

- **Rectangular:** The geometry is defined by width and height.
- **Irregular:** The geometry is defined using a level-width table or a depth-width table. Select the relevant table type and click on the Insert button to add rows to the table. Note that the values in the first column (level or depth) must be increasing.

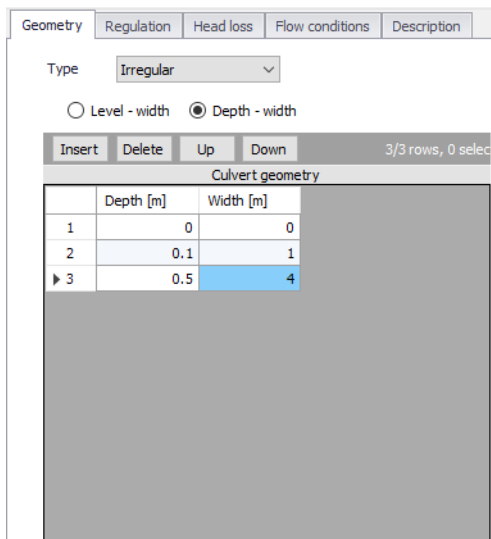

- **Circular:** The geometry is specified by a diameter.
- **From topography file:** The culvert geometry is specified in the cross section editor. Select the Link Name (Branch ID), Topo ID, and Chainage of the cross section describing the structure's geometry. If the cross section is an opened cross section, the structure will be an open culvert which is never submerged.



Geometry	Regulation	Head loss	Flow conditions	Description
Type	From topography file			
Geometry link name	Culvert	...		
Geometry topo ID	Culvert 2020	...		
Geometry chainage	0	[m]	...	

### Upstream Invert

Invert level of the upstream end of the culvert.

### Downstream Invert

Invert level of the downstream end of the culvert.

### Length

Length of the culvert.

### Number of Culverts

Number of parallel culverts.

### Structure plot

To help ensuring that the geometry of the culvert is properly defined, the culvert's shape is shown and is compared to its upstream and downstream cross sections. On this plot, the horizontal axis shows the X-coordinates from the upstream cross section. The downstream cross section is then shifted so that its marker 2 is aligned with the marker 2 from the upstream cross section. The culvert shape is also centered around this marker 2, but can be moved horizontally using the value 'Horizontal offset from marker 2'.

Note that this horizontal offset value is only used for the visualization purpose and has no impact on the simulation. Also note that the structure shape is always plotted in a symmetric manner although the actual structure may be asymmetric, and this doesn't affect the simulation neither as long as the flow area in the structure is correct.



**Note:** Since a culvert is defined as a structure causing a contraction loss, a friction loss (bend loss) and subsequently an expansion loss, the geometry of the culvert must be such that the cross sectional area at the inflow is less than the cross sectional area upstream of the culvert for all water levels. Similarly, the cross sectional area at the outflow end must be less than the cross sectional area immediately downstream of the culvert.

## Regulation

Explicit regulation of flows through the structure may be set in the Regulation tab page of the Culverts editor (Figure 3.59).

Figure 3.59 The Regulation tab page on the Culverts editor

### Non Return Flap

Activate this option to allow control of flow direction through the structure:

- **Only Positive Flow:** Only positive flow is allowed, i.e. whenever the water level downstream is higher than upstream, the flow through the structure will be zero.
- **Only Negative Flow:** Only negative flow is allowed, i.e. whenever the water level upstream is higher than downstream, the flow through the structure will be zero.
- **No Flow:** The flow through structures will always be zero regardless of upstream and downstream water levels.

### Section Type

The culvert type must be specified as either open or closed for rectangular and irregular culverts. Circular culverts are closed, and culverts defined with a cross section definition are defined as open or closed in the Cross Sections editor/file.

### Apply flow factor

When this option is active, the discharge computed through the culvert is multiplied by a flow factor. This factor's value is specified in the Flow factor field. The factor is a dimensionless factor, and a value of 1 means that no change is applied to the computed discharge. A value lower than 1 can typically be used to describe the reduction of the flow through the structure due to obstacles, like debris, restricting the flow area in the structure.

## Head Loss

Define head loss parameters for the structure on the Head Loss tab page of the Culverts editor.

Head loss variables are included in the calculation of the flow direction-dependent energy loss for flow through hydraulic structures. They include:

- **Manning's n:** Manning bed resistance number along the culvert (for calculation of the friction loss through a structure with a certain length).





- **Positive/Negative flow.** Local head loss factors are defined for Inflow (entrance), Outflow (exit), Free overflow (correction coefficient), and Bends. Different loss factors can be applied depending on the flow direction across the structure.

Geometry	Regulation	Head loss	Flow conditions	Description
Manning's n <input type="text" value="0.02"/> [s/m <sup>1/3</sup> ]				
	Inflow	Outflow	Free overflow	Bends
Positive flow	<input type="text" value="0.5"/>	<input type="text" value="1"/>	<input type="text" value="1"/>	<input type="text" value="0"/>
Negative flow	<input type="text" value="0.5"/>	<input type="text" value="1"/>	<input type="text" value="1"/>	<input type="text" value="0"/>
Computational method		<input type="text" value="Energy equation"/>		

Figure 3.60 The Head Loss tab page of the Culverts editor

Besides, a computational method must be selected. Two options are available:

- **Energy equation:** with this method, the flow through the structure is solved using the energy equation, in order to compute the discharge in the structure as a function of the head loss factors. The computed discharge is then applied at the calculation point. This is the preferred option in case there are big changes in cross sections before and after the structure, or if the flow area of the structure is much less than that of the river.
- **Shallow water equation:** with this method, the flow through the structure is solved adding a head loss term to the shallow water equation (Saint-Venant momentum equation), this term being a function of the head loss factors. With this method, the same equation is applied at structures' locations as at other regular calculation points (without structures). This ensures a continuity of the results between the upstream / downstream reaches and the structure, e.g. also including a bed friction between the upstream and downstream cross sections of the structure. Additionally, this method also enforces the use of velocity in upstream and downstream cross sections to compute the head loss, instead of using the velocity in the structure. This option is mainly designed for scenarios where the structure creates little or no head loss for low water levels, as e.g. for an overarching bridge. See the "Head loss mode" in the MIKE 1D reference manual, for more information.

Notes: When the flow through the structure becomes supercritical, the applied method is always the Energy equation. Besides, the 'Shallow water equation' method cannot be applied for structures located on rivers of type 'Structure link'. When several structures exist at the same location, if any of them uses the Shallow water equation method, then all other structures at the same location will also apply the same equation no matter the selected method in their properties.



## Flow Conditions

Flow condition parameters through structures are shown in the Flow Conditions tab page of the editor (Figure 3.61).

Figure 3.61 shows the Flow Conditions tab page of the Culverts editor. The interface includes tabs for Geometry, Regulation, Head loss, Flow conditions, and Description. The 'Flow conditions' tab is active, showing a 'No. of Q/h relations' field set to 40 and a 'Calculate Q/h relations' button. Below this are four tables: 'Positive flow Q/h relations', 'Negative flow Q/h relations', 'Positive orifice flow', and 'Negative orifice flow'. Each table has columns for depth (y [m]), discharge (Qc [m<sup>3</sup>/s]), orifice diameter (y/D), and coefficient (Co). At the bottom is a 'Hydraulic Parameters' table with columns for depth (y [m]), Area [m<sup>2</sup>], Radius [m], and Conveyance [m<sup>3</sup>/s].

Figure 3.61 The Flow Conditions tab page of the Culverts editor

Different hydraulic relations for the structure are automatically calculated by clicking on the 'Calculate Q/h relations' button once 'No. of Q/h relations' (i.e. data rows) has been specified.

### Allow for Recalculation

Q/h relations can either be calculated automatically or entered/edited manually. If the Q/h relations have been modified manually, it is possible to prevent further changes to the values by unchecking 'Allow for recalculation'. This will ensure that Q/h relations for this structure are not recalculated through the 'Recalculate flow conditions' function.

### Q/h Relations

The Q/h relations are given as Q/y relations (where y is depth above the lowest of the Upstream and Downstream invert levels). The Q/y relations table also shows the type of flow occurring for the actual levels. Please note that the flow type definitions in the tables are only flow indicators derived from the Q/h table calculation, and these indicators are not directly impacting the calculation results. Hence, there will be no effect of changing these flow-type definitions on the calculation results.



Q/h Relations				
Positive flow Q/h relations				
	y [m]	Qc [m <sup>3</sup> /s]	Type	
1	0	0	No flow	
2	0.0110836	0.000203572	Outlet C	
▶ 3	0.0440679	0.00320538	Inlet C	
4	0.0980911	0.0158001	Inlet C	

The possible flow types are:

- **No Flow:** No flow occurs at the first level ( $y = 0$ ) and when the flap regulation flag prohibits flow in one direction.
- **Inlet C:** The flow at the inlet is critical.
- **Outlet C:** The flow at the outlet is critical. A backwater curve using a fine resolution is calculated to relate the discharge to the upstream water level in the river.
- **Orifice:** The flow at the culvert inlet has an orifice type formation.
- **Full:** The culvert is fully wet with a free discharge at the outlet.

### Orifice Flow Coefficients

Orifice type discharge is calculated based on the orifice coefficient tables shown in the this table. These coefficients can be edited, added or deleted, if needed. After editing the Orifice flow coefficients it is required to recalculate the Q/h relations using the 'Calculate Q/h relations' button.

Orifice Flow Coefficient					
Positive orifice flow coefficients			Negative orifice flow coefficients		
	y/D	Co		y/D	Co
▶ 1	1	0.65	▶ 1	1	0.65
2	5	0.65	2	5	0.65

### Hydraulic Parameters

The hydraulic parameters table shows level dependent parameters used in the calculation of Q/h relations. The hydraulic parameters are also used internally in the hydrodynamic engine when calculating the structure flow for other flow conditions than the free outflow. Hydraulic parameters include Flow Area, Hydraulic Radius, and Conveyance calculated for the level 'y' (depth above culvert invert).



Hydraulic Parameters				
Insert	Delete	Up	Down	1/21 rows, 0 selected
Hydraulic parameters				
	y [m]	Area [m <sup>2</sup> ]	Radius [m]	Conveyance [m <sup>3</sup> /s]
▶ 1	0	1E-05	0.000177828	3.16228E-08
2	0.007387	0.000925609	0.00491051	2.6741E-05
3	0.0293661	0.00729599	0.0193532	0.00052592
4	0.0653961	0.0240229	0.0424819	0.0029248
5	0.11459	0.0550045	0.072952	0.00960336

To compute the Q/h relations, the nearest upstream and downstream cross sections are used. The cross sections must be located within a distance which is smaller than the user-defined maximum grid-spacing ('Max dx') for the branch in question. The Q/h relations cannot be calculated unless cross sections are defined.



**Note** that Q/h relations must be re-calculated if any changes are made to the culvert and/or up/downstream cross sections. This is done by either pressing the 'Calculate Q/h relations' button on the editor for an individual structure or using the 'Recalculate flow conditions' function on the River Network menu ribbon.

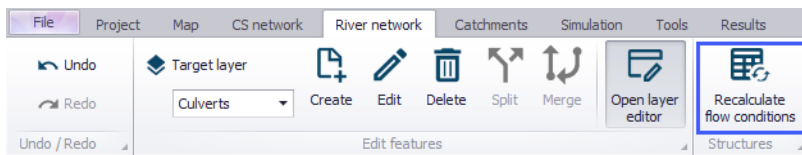

Figure 3.62 The Recalculate Flow Conditions function on the River Network menu ribbon

## Description

Use the Description tab page to add free text descriptions for culverts (Figure 3.63). It offers options for providing asset and model management information, as well as attributes for quick model data query.



Figure 3.63 The Description tab page on the Culverts editor

- **Description:** Free text description for the culvert.
- **Data source:** Free text describing data source for culvert data.
- **Status:** Project-defined status information that may be used for model build management or e.g. model data query. Pre-defined codes are contained in the Status Code editor (Figure 3.15) which may be accessed via the ellipsis button from the Status dropdown menu (see Figure 3.63).
- **Add picture:** Option for adding images associated with the culvert structure.

### 3.6.2 Weirs

Weirs, which are essentially low flow barriers across river widths causing changes to flow characteristics, may be modelled for river networks in MIKE+ via the Weirs editor accessed under the River Network setup group (Figure 3.64).

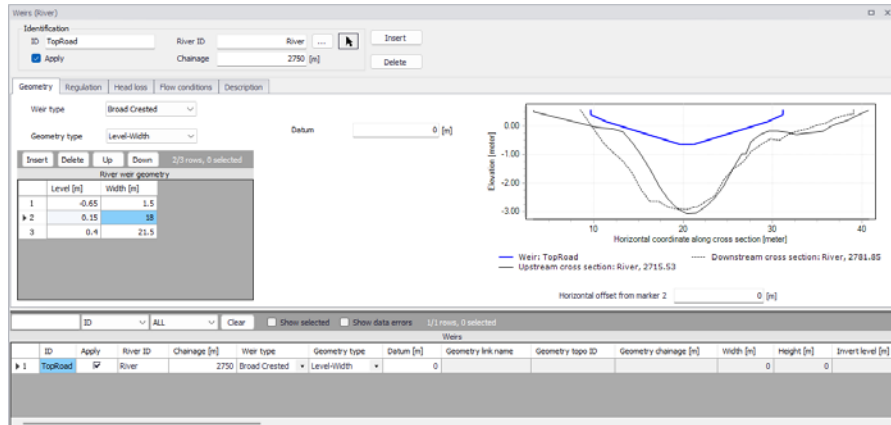

Figure 3.64 The Weirs editor accessed through the River Network setup group

Define weirs along river networks in MIKE+ via the main Map setting the Target Layer for feature editing to 'Weirs.' See Structures (p. 84).

Alternatively, define weir structures via the Weirs editor using the 'Insert' button.

## Identification

The Identification groupbox holds general information on the weir structures.

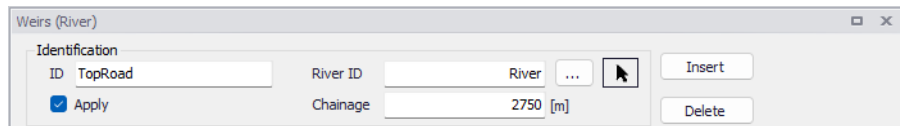

### ID

Unique string identification for the weir.

### River ID

The river branch ID where the weir is located. Use the button with an arrow, to select the location of the structure on the map: this will specify both the River ID and the Chainage of the structure

### Chainage

Chainage along the river branch where the weir is located.

### Apply

This check box allows the user to toggle the Active status of the weir on and off. The simulations will omit all weirs that are not active.



## Geometry

Structure type and geometric properties for weirs are defined in the Geometry tab page of the Weirs editor (Figure 3.65).

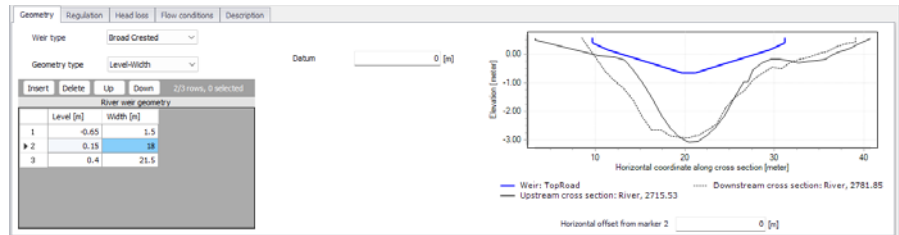

Figure 3.65 The Geometry tab page on the Weirs editor

## Weir Type

The Weir Type defines the type of weir formulation used to calculate flow dynamics over the structure.

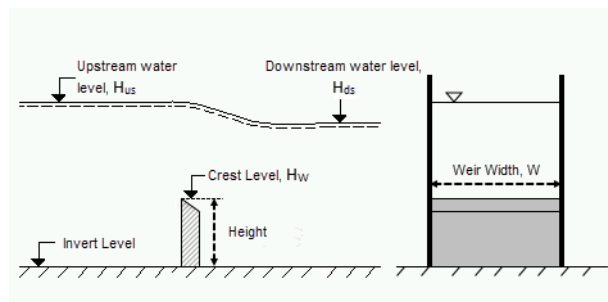

Figure 3.66 Weir formula parameters

The weir formulation may be defined as:

- **Broad Crested.** For Broad Crested weirs a hydrostatic pressure condition is assumed and the  $Q/h$  relationship is calculated automatically.

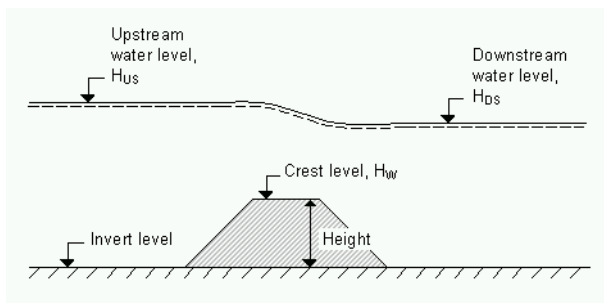

Figure 3.67 Broad crested weir

Broad crested weir Geometry Type may be:

- Level-Width: The weir geometry is defined in a Level/Width table with levels (relative to the datum) and corresponding flow widths (See Figure 3.65).

The Datum is the vertical offset added to the level column in the level/width table.

The Level/Width table holds user defined levels and corresponding flow widths. Click on the Insert button to add rows to the table. Note that values in the ‘Level’ column must be increasing.

Geometry type

Insert Delete Up Down 1/2 rows, 0 selected

River weir geometry		
	Level [m]	Width [m]
▶ 1	0.5	5
2	1	5

- From topography file: The weir geometry is specified in the Cross Sections editor. Select the link name (i.e. Branch ID), topo ID, and chainage for the cross section describing the structure geometry.





Geometry	Regulation	Head loss	Flow conditions	Description
Weir type	Broad Crested			
Geometry type	From topography file			
Geometry link name	Weir	...		
Geometry topo ID	Weir 2020	...		
Geometry chainage	0 [m]	...		

- **Villemonte Formula.** A standard weir expression reduced according to the Villemonte formula is applied. Also see the MIKE 1D Reference Manual for more details.

Define the following parameters (Figure 3.66):

- Width. Width of the flow,  $W$ .
- Height. Weir height.
- Invert Level. Bottom datum level.
- Weir Coefficient. Weir coefficient is the multiplication coefficient 'C' in the weir formula.
- Weir Exponential Coefficient. Weir exponent coefficient is the exponential coefficient 'k' in the weir formula.

The Villemonte formula reads:

$$Q = W \cdot C \cdot (H_{US} - H_W)^k \cdot \left[ 1 - \left( \frac{H_{ds} - H_W}{H_{US} - H_W} \right)^{0,385} \right] \quad (3.3)$$

Where  $Q$  is discharge through the structure,  $W$  is width,  $C$  is weir coefficient,  $k$  is the weir exponential coefficient,  $H_{US}$  is upstream water level,  $H_{ds}$  is downstream water level and  $H_W$  is weir level (i.e. Invert Level + Height).

- **Honma Formula.** The Honma weir expression. Also see the MIKE 1D Reference Manual for more details.

Define the following parameters (Figure 3.66):

- Width. Width of the flow,  $W$ .
- Crest Level. Weir level,  $H_W$ .
- Weir Coefficient. The weir coefficient is the multiplication coefficient 'C<sub>1</sub>' of the Honma weir formula.



The Honma formula reads:

$$Q = \begin{cases} C_1 W(H_{us} - H_w) \sqrt{(H_{us} - H_w)} & \text{for } (H_{ds} - H_w)/H_{us} < 2/3 \\ C_2 W(H_{ds} - H_w) \sqrt{(H_{us} - H_{ds})} & \text{for } (H_{ds} - H_w)/H_{us} \geq 2/3 \end{cases} \quad (3.4)$$

Where  $Q$  is the discharge through the structure,  $W$  is the width,  $C_1$  is the first weir coefficient,  $C_2 = (3/2)\sqrt{3}C_1$  is the second weir coefficient,  $H_{us}$  is the upstream water level,  $H_{ds}$  is the downstream water level, and  $H_w$  is weir level

- **Extended Honma Formula.** An extended version of the Honma weir formula is applied.

The Extended Honma formula calculates the flow in three flow regimes: 1) Perfect flow, 2) Imperfect flow, and 3) Submerged overflow. The equations reads:

$$Q = \begin{cases} \left[ C_0 W h_u^{3/2} \right. & , \text{ Perfect} \\ \left. C_0 (\text{Alpha} \cdot (h_d/h_u)^q + \text{Beta}) W h_u^{3/2} \right. & , \text{ Imperfect} \\ \left. C_0 (\text{Gamma} \cdot (h_d/h_u)^r + \text{Delta}) W h_d (h_u - h_d)^{1/2} \right. & , \text{ Submerged} \end{cases} \quad (3.5)$$

where

$$C_0 = a \cdot (h_u/H)^p + b$$

$W$  is weir width

$H$  is weir height above cross section invert

$h_d$  is the upstream water level above the crest

$h_u$  is the down stream water level above the crest

Provide values for the following parameters:

- Width. Width of the flow,  $W$ .
- Height. Weir height,  $H$ .
- Crest Level. Weir level.
- Perfect overflow parameters:  
 $(h_d/h_u)_i$  is the depth ratio limit between perfect and imperfect flow regime.  
Parameters  $a$ ,  $b$  and  $p$  are used to calculate the weir coefficient  $C_0$ .
- Imperfect overflow parameters  
Parameters  $\text{Alpha}$ ,  $\text{Beta}$  and  $q$  are used in imperfect overflow calculation



- Submerged overflow parameters  
 $(h_d/h_w)_s$  is the depth ratio limit between imperfect and submerged flow regime.  
 Parameters Gamma, Delta and r used in submerged overflow calculation.

**Note:** It is not checked if there is a continuous transition from one flow regime to the next. This has to be ensured by the user through proper selection of the parameters.

Also see the MIKE 1D Reference Manual for more details.

### Structure plot

To help ensuring that the geometry of the weir is properly defined, the weir's shape is shown and is compared to its upstream and downstream cross sections. On this plot, the horizontal axis shows the X-coordinates from the upstream cross section. The downstream cross section is then shifted so that its marker 2 is aligned with the marker 2 from the upstream cross section. The weir shape is also centered around this marker 2, but can be moved horizontally using the value 'Horizontal offset from marker 2'.

Note that this horizontal offset value is only used for the visualization purpose and has no impact on the simulation. Also note that the structure shape is always plotted in a symmetric manner although the actual structure may be asymmetric, and this doesn't affect the simulation neither as long as the flow area in the structure is correct.



**Note:** Since a weir is a structure causing a contraction loss and subsequently an expansion loss, the geometry of the weir must be such that the cross sectional area at the weir is less than the cross sectional area at both the upstream and the downstream cross sections for all water levels.

## Regulation

Flow regulation setting may be defined for river network weirs via the Regulation tab page of the Weirs editor.

The screenshot shows the 'Regulation' tab of the Weirs editor. It contains the following elements:

- Tab headers: Geometry, Regulation (selected), Head loss, Flow conditions, Description.
- Non return flap:  Non return flap. A dropdown menu is set to 'Only negative flow'.
- Flow blockage:  Apply flow factor. A text input field contains the value '1' with a unit indicator '[0]'.

Figure 3.68 The Regulation tab page on the Weirs editor



## Non Return Flap

Activate the 'Non return flap' option to control the direction of flow over weirs:

- **Only Positive Flow:** Only positive flow is allowed, i.e. whenever the water level downstream is higher than upstream, the flow through the structure will be zero.
- **Only Negative Flow:** Only negative flow is allowed, i.e. whenever the water level upstream is higher than downstream the flow through the structure will be zero.
- **No Flow:** The flow through structures will always be zero regardless of upstream and downstream water levels.

## Apply flow factor

When this option is active, the discharge computed through the weir is multiplied by a flow factor. This factor's value is specified in the Flow factor field. The factor is a dimensionless factor, and a value of 1 means that no change is applied to the computed discharge. A value lower than 1 can typically be used to describe the reduction of the flow through the structure due to obstacles, like debris, restricting the flow area in the structure.

## Head Loss

For **broad crested** weirs, parameters for computing energy loss through the structure may be defined via the Head Loss tab page (Figure 3.69).

	Inflow	Outflow	Free overflow
Positive flow	<input type="text" value="0.5"/>	<input type="text" value="1"/>	<input type="text" value="1"/>
Negative flow	<input type="text" value="0.5"/>	<input type="text" value="1"/>	<input type="text" value="1"/>

Computational method:  ▾

Figure 3.69 The Head Loss tab page for broad crested weirs

Head loss factors may be defined depending on flow direction across the weir (positive or negative flow direction).

Besides, a computational method must be selected. Two options are available:



- Energy equation: with this method, the flow through the structure is solved using the energy equation, in order to compute the discharge in the structure as a function of the head loss factors. The computed discharge is then applied at the calculation point. This is the preferred option in case there are big changes in cross sections before and after the structure, or if the flow area of the structure is much less than that of the river.
- Shallow water equation: with this method, the flow through the structure is solved adding a head loss term to the shallow water equation (Saint-Venant momentum equation), this term being a function of the head loss factors. With this method, the same equation is applied at structures' locations as at other regular calculation points (without structures). This ensures a continuity of the results between the upstream / downstream reaches and the structure, e.g. also including a bed friction between the upstream and downstream cross sections of the structure. Additionally, this method also enforces the use of velocity in upstream and downstream cross sections to compute the head loss, instead of using the velocity in the structure. This option is mainly designed for scenarios where the structure creates little or no head loss for low water levels, as e.g. for an overarching bridge. See the "Head loss mode" in the MIKE 1D reference manual, for more information.

Note: When the flow through the structure becomes supercritical, the applied method is always the Energy equation. Besides, the 'Shallow water equation' method cannot be applied for structures located on rivers of type 'Structure link'. When several structures exist at the same location, if any of them uses the Shallow water equation method, then all other structures at the same location will also apply the same equation no matter the selected method in their properties.

## Flow Conditions

For **broad crested** weirs, a tab for Flow Conditions is available. Free over-flow Q/h relations are calculated automatically by clicking on the 'Calculate Q/h relations' button once the 'No. of Q/h relations' value has been specified.

### Allow for Recalculation

Q/h relations can either be calculated automatically or entered/edited manually. If the Q/h relations have been modified manually it is possible to lock the values by disabling the 'Allow for recalculation' option. This will ensure that Q/h relations for this structure are not recalculated.



Geometry	Regulation	Head loss	Flow conditions	Description		
<input checked="" type="checkbox"/> Allow for recalculation		No of Q/h relations		40	Calculate Q/h relations	
Q/h Relations						
Insert		Delete		Up		Down
1/40 rows, 0 selected						
Weir Qh relations						
	Q [m <sup>3</sup> /s]	H-Pos [m]	H-Neg [m]	H-Weir [m]	Width [m]	Area [m <sup>2</sup> ]
▶ 1	0	5	5	5	1	0
2	0.00454677	5.02238	5.0224	5.01282	1	0.0128207
3	0.0128602	5.04464	5.04473	5.02564	1	0.0256414
4	0.0236257	5.0668	5.06701	5.03846	1	0.0384622
5	0.0363742	5.08888	5.08922	5.05128	1	0.0512829
6	0.0508345	5.11087	5.11139	5.0641	1	0.0641036
7	0.0668236	5.13279	5.1335	5.07692	1	0.0769243
8	0.0842074	5.15464	5.15557	5.08975	1	0.089745
9	0.102882	5.17643	5.17761	5.10257	1	0.102566

Figure 3.70 The Flow Conditions tab page for broad crested weirs

The results of the Q/H relations calculations are shown in the Q/h Relations table and includes values for:

- **Q:** Structure discharge
- **H-Pos:** Level upstream in case of positive flow
- **H-Neg:** Level downstream in case of negative flow
- **H-Weir:** Level at structure
- **Width:** Structure width for actual structure level
- **Area:** Structure area for actual structure level

To compute Q/h relation values, the nearest upstream and downstream cross sections are used. The cross sections must be located within a distance which is smaller than the user-defined maximum grid-spacing ('Max dx') for the river branch in question. The Q/h relations cannot be calculated unless cross sections are defined.



**Note** that Q/h relations must be re-calculated if changes are made to the weir and/or up/downstream cross sections. This is done using the 'Calculate Q/h relations' button for an individual structure or using the 'Recalculate flow conditions' tool in the 'River Network' menu ribbon.

## Description

Use the Description tab page to add free text descriptions for weirs (Figure 3.71). It offers options for providing asset and model management information, as well as attributes for quick model data query.



Figure 3.71 The Description tab page on the Weirs editor

- **Description:** Free text description for the weir structure.
- **Data source:** Free text describing data source for the weir data.
- **Status:** Project-defined status information that may be used for model build management or e.g. model data query. Pre-defined codes are contained in the Status Code editor (Figure 3.15) which may be accessed via the ellipsis button from the Status dropdown menu (see Figure 3.71).
- **Add picture:** Option for adding images associated with the weir structure.

### 3.6.3 Bridges

#### Working with bridges

'Bridge'-type structures are defined by one or more openings. The Bridges editor is therefore split into two parts:

- The main structure is defined in the primary table, in the left part of the editor. The main structure primarily stores information about the location of the bridge.
- The list of openings for the active main structure is defined in the secondary table, in the right part of the editor. Openings describe the various apertures under the bridge. Each opening is bound to the main structure on which it has been created, and a minimum of one opening is required for each main structure.

Figure 3.72 illustrates an example of bridge containing multiple openings.

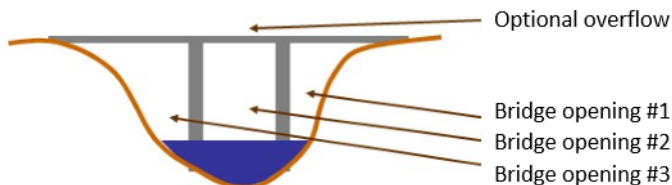

Figure 3.72 Example of bridge openings

A main structure may be added or removed from the map, or from the primary table on the left. Openings can only be controlled from the right part of the editor. Removing a main structure will remove all its openings as well.

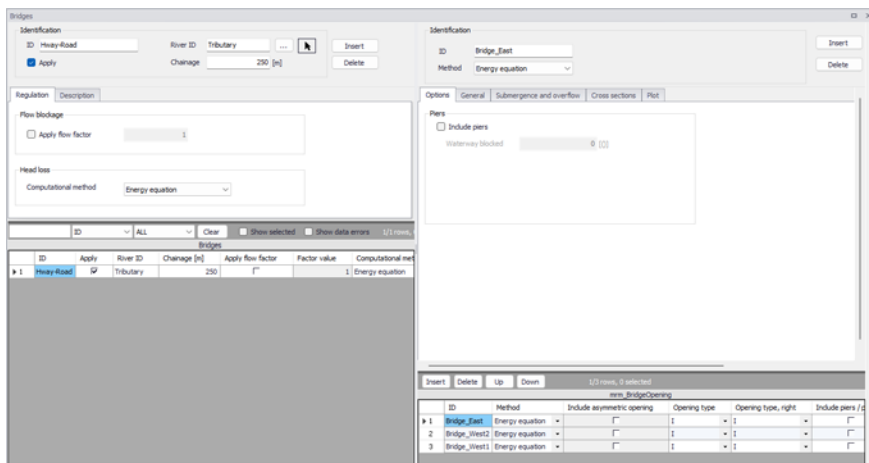

Figure 3.73 The Bridges editor accessed via the River Network setup group

## Identification of the main structure

The Identification group holds basic information on bridges structures.

### ID

Unique string identification for the bridge.

### River ID

The ID of the river where the bridge is located. The River ID is automatically registered if the bridge is created via the Map. Use the button with an arrow, to select the location of the structure on the map: this will specify both the River ID and the Chainage of the structure.

### Chainage

Chainage at which the bridge is located along the river.





### Apply

This check box allows the user to toggle the Active status of the bridge on and off. The simulations will omit all bridges that are not active.

## Regulation

### Apply flow factor

When this option is active, the total discharge computed through the bridge (i.e. the sum of discharges through the various openings) is multiplied by a flow factor. This factor's value is specified in the Flow factor field. The factor is a dimensionless factor, and a value of 1 means that no change is applied to the computed discharge. A value lower than 1 can typically be used to describe the reduction of the flow through the structure due to obstacles, like debris, restricting the flow area in the structure.

### Computational method

Two computational methods are available:

- **Energy equation:** with this method, the flow through the structure is solved using the energy equation, in order to compute the discharge in the structure as a function of the head loss factors. The computed discharge is then applied at the calculation point. . This is the preferred option in case there are big changes in cross sections before and after the structure, or if the flow area of the structure is much less than that of the river.
- **Shallow water equation:** with this method, the flow through the structure is solved adding a head loss term to the shallow water equation (Saint-Venant momentum equation), this term being a function of the head loss factors. With this method, the same equation is applied at structures' locations as at other regular calculation points (without structures). This ensures a continuity of the results between the upstream / downstream reaches and the structure, e.g. also including a bed friction between the upstream and downstream cross sections of the structure. Additionally, this method also enforces the use of velocity in upstream and downstream cross sections to compute the head loss, instead of using the velocity in the structure. This option is mainly designed for scenarios where the structure creates little or no head loss for low water levels, as e.g. for an overarching bridge. See the "Head loss mode" in the MIKE 1D reference manual, for more information.

Note: When the flow through the structure becomes supercritical, the applied method is always the Energy equation. Besides, the 'Shallow water equation' method cannot be applied for structures located on rivers of type 'Structure link'. When several structures exist at the same location, if any of them uses the Shallow water equation method, then all other structures at the same location will also apply the same equation no matter the selected method in their properties.

## Description

Use the Description tab to add free text descriptions for bridges structures (Figure 3.77). It offers options for providing model management information, as well as attributes for quick model data query.

Figure 3.74 The Description tab on the Bridges structures editor

- **Description:** Free text description for the tabulated structures.
- **Data source:** Free text describing data source for tabulated structures data.
- **Status:** Project-defined status information that may be used for model build management or e.g. model data query. Pre-defined codes are contained in the Status Code editor (Figure 3.15) which may be accessed via the ellipsis button from the Status dropdown menu (see Figure 3.74).
- **Add picture:** Option for adding images associated with the tabulated structure.

## Identification of the opening

This Identification group holds basic information on the bridge's opening.

### ID

Unique string identification for the opening.

### Method

The method controls the equation applied to describe the free surface flow through the opening. The available methods can be divided into pure free flow methods and methods which may be combined with submergence/overflow methods. The pure free flow methods can be further subdivided into methods for piers and methods for arches. The choice of method should be based on the assumptions for the different methods and the requirements of the modelling. The available methods are:

- **Energy equation:** a standard step method where a backwater surface profile determination is used to calculate the discharge through the opening. The method takes the contraction and expansion loss for bridges of arbitrary shape into account. The method assumes subcritical flow and may default to critical flow for steep water surface gradients.



- FHWA WSPRO: the Federal Highway Administration (FHWA) WSPRO method is based on the solution of the energy equation. Contraction loss is taken into account through the calculation of an effective flow length. Expansion losses are determined through the use of numerous experimentally based tables. The method takes the effect of eccentricity, skewness, wingwalls, embankment slope etc. into account through the use of these tables.
- USBPR: the US Bureau of Public Roads (USBPR) method estimates free surface flow assuming normal depth conditions. The method is based on experiments and takes the effect of eccentricity, skewness and piers into account.
- Yarnell piers: an equation derived from experiments for normal flow conditions in the subcritical flow range. The effect of piers is handled through the use of adjustment factors.
- Nagler piers: an orifice type of flow description with the effect of the piers taken into account through an adjustment factor.
- Hydraulic Research arch: the Hydraulic Research method is based on laboratory experiments of both single and multi-spanned arch bridges in rectangular channels. The method uses tables describing the relationship between the blockage ratio, the downstream Froude number and the upstream water level.
- Biery and Delleur arch: an orifice type of equation is used to describe the discharge through the opening. The equation is derived under the assumption of a rectangular channel and is based on a single span arch opening. Multiple arch openings are handled by a simple multiplication factor.

#### Include asymmetric opening

Used for individual definition of left and right abutments' properties. When this option is active, most of the opening's parameters have to be defined separately for the left and for the right side. This option is only available with the FHWA WSPRO method.

#### Opening type

For the FHWA WSPRO method, the opening type describes the type of embankment and abutment, through four different types: I, II, III and IV.

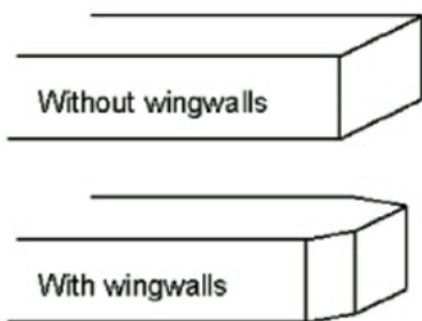

Figure 3.75 Definition sketch of opening type I (vertical embankments and vertical abutments, with or without wingwalls) (after Matthai)

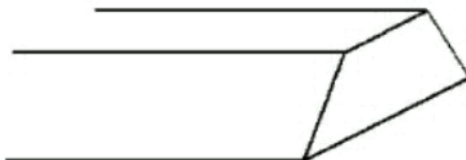

Figure 3.76 Definition sketch of opening type II (sloping embankments without wingwalls) (after Matthai)



Figure 3.77 Definition sketch of opening type III (sloping embankments and sloping abutments; spillthrough) (after Matthai)

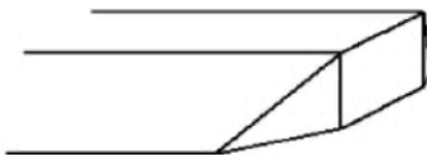

Figure 3.78 Definition sketch of opening type IV (sloping embankments and vertical abutments with wingwalls) (after Matthai)

## Options

Additional options may be added to the free surface flow calculation. Available options depend on the selected method. To include an option, simply tick the corresponding box.

Most of the options are taken into account through the use of adjustment factors defined in tables. It is possible to either use the default tables or use custom tables.

### Piers and piles.

This option may be used to include the effect of piers and piles on the free surface flow calculation.

### *Waterway blocked*

The proportion of the waterway blocked by piers/piles.

### *Type*

For the FHWA WSPRO method, two types are available:

- Piers
- Piles.

For the USBPR method, the following types of piers are available:

- Single cylinder
- Twin cylinder 1
- Twin cylinder 2
- Series of cylinder
- Single squared
- Twin squared 1
- Twin squared 2
- Series of squared
- Semi-circular



- Series of I-formed.

#### *Use custom table*

When this option is unchecked, the simulation uses the default loss tables for piers and piles. When checked, the simulation uses user-defined tables, which are selected in the corresponding fields, using the ellipsis button.

For the FHWA WSPRO method with type 'Piers', the table must be defined in the 'Curves and relations' editor, and with a type 'Bridge FHWA WSPRO piers'. For the FHWA WSPRO method with type 'Piles', two table must be defined:

- The expected type for the first / upper table depends on the opening type. For the opening type I, the table must be defined in the 'Curves and relations' editor, and with a type 'Bridge FHWA WSPRO piles type I'. For the other opening types, the table must be defined in the 'Two-dimensional tables' editor, and with type 'Bridge FHWA WSPRO piles' to store the values of the adjustment factor  $k_p$  (for  $j=0.1$ ).
- The second / lower table must be defined in the 'Curves and relations' editor, and with type 'Bridge FHWA WSPRO piles table 2'

For the USBPR method, the table must be defined the 'Curves and relations' editor, and with a type 'Bridge USBPR piers'.

Please refer to the reference manual for descriptions of variables used in the tables.

#### **Skewness**

Skewness can be applied when the abutments are not perpendicular to the flow direction.

#### *Angle*

Angle describing the orientation of abutments.

#### *Use custom table*

When this option is unchecked, the simulation uses the default loss table for skewness. When checked, the simulation uses a user-defined table, which is selected in the corresponding field, using the ellipsis button.

The table must be defined in the 'Curves and relations' editor, and with a type 'Bridge USBPR skewness'.

Please refer to the reference manual for descriptions of variables used in the table.

#### **Eccentricity**

Eccentricity can be applied when the bridge opening is eccentrically located in the river.



### *Use custom table*

When this option is unchecked, the simulation uses the default loss table for eccentricity. When checked, the simulation uses a user-defined table, which is selected in the corresponding field, using the ellipsis button.

For the FHWA WSPRO method, the table must be defined in the 'Curves and relations' editor, and with a type 'Bridge FHWA WSPRO eccentricity'. For the USBPR method, the table must be defined in the 'Two-dimensional tables' editor, and with a type 'Bridge USBPR eccentricity' to store the values of the parameter  $k_e$ .

Please refer to the reference manual for descriptions of variables used in the table.

### *Spur dykes*

This option may be used to include the effect of spur dykes on the free surface flow calculation.

### *Use custom table*

When this option is unchecked, the simulation uses the default loss tables for spur dykes. When checked, the simulation uses user-defined tables, which are selected in the corresponding fields, using the ellipsis buttons.

For the opening types I, II and IV, only one table is used: it must be defined in the 'Curves and relations' editor, and with a type 'Bridge FHWA WSPRO spur dyke'. For the opening type III, two tables are used:

- The first / upper table must be defined in the 'Two-dimensional tables' editor, and with type 'Bridge FHWA WSPRO spur dyke III'. It stores values for the  $k_d$  parameter.
- The second / lower table must be defined in the 'Two-dimensional tables' editor, and also with type 'Bridge FHWA WSPRO spur dyke III', but this one stores values for the  $k_a$  parameter.

Please refer to the reference manual for descriptions of variables used in the tables.

### *Length*

The length of the spur dyke.

### *Type*

The type of the spur dyke, which can be either straight or elliptical.

### *Angle*

The angle, for an elliptical spur dyke.

### *Offset*

The offset, for a straight spur dyke.



## General

The parameters available here control the free surface flow equations applied for the active opening. The number of parameters depends on the selected method.

### *Roughness type*

Defines the type of roughness value specified for the opening. The type can be either Manning's M or Manning's n.

### *Roughness value*

The value for the roughness on the bridge structure.

This roughness value will per default apply all along the bridge's cross sections. However, if these cross sections have markers 'Left abutment' and 'Right abutment' specified, then it is assumed that the part of the cross sections in-between represents the river bed, and the roughness applied between these markers is obtained from the roughness applied to the upstream and downstream cross sections. In this case, the roughness value specified for the opening only applies from the left extent of the bridge's cross section to 'Left abutment' marker, and from 'Right abutment' marker to the right extent of the bridge's cross section.

### *Ratio*

Selects between the channel contraction ratio ( $m=1-M$ ) or bridge opening ratio (M) as parameter in the various tables.

### *Waterway length*

Length of the waterway in the flow direction.

### *Level of waterway length*

The level at which the waterway length is measured.

### *Contraction loss coef.*

The contraction loss factor.

### *Expansion loss coef.*

The expansion loss factor.

### *Opening width*

For an arch: opening width at the arch spring line (b, in figure below). For piers: total opening width between the piers.



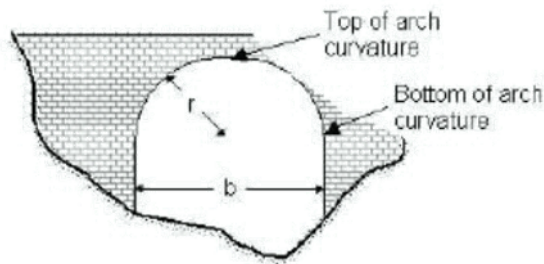

Figure 3.79 Geometrical description of an arch

### *Type of piers*

Describes the shape of the piers:

- Squared
- Semi-circular
- 90-degree triangular
- Twin cylinder without diaphragm
- Twin cylinder with diaphragm
- Lens-shaped
- Ten pile trestle bent (only available for Yarnell piers)

The selected type of piers is only used when applying predefined tables of coefficients. When working with custom tables instead, the type of piers is not used.

### *Number of arches*

The number of arches in the opening.

### *Level of bottom of arch curvature.*

Level of arch spring line, shown on Figure 3.79 above.

### *Level of top of arch curvature*

Level of upper most point in the arch, shown on Figure 3.79 above.

### *Radius of arch curvature*

Radius of the arch ( $r$ , in Figure 3.79 above).

### *Use custom table*

When this option is unchecked, default loss factor tables are used in the simulation. When checked, a user-defined table may be used, which is selected in the corresponding field, using the ellipsis button.



For the Yarnell piers method, the table must be defined in the 'Curves and relations' editor, and with a type 'Bridge Yarnell piers'. For the Nagler piers method, the table must be defined in the 'Curves and relations' editor, and with a type 'Bridge Nagler piers'. For the Hydraulic Research arch method, the table must be defined in the 'Two-dimensional tables' editor, and with a type 'Bridge Hydraulic Research arch' to store values for the parameter  $H1/Y4$ . For the Biery and Delleur arch method, the table must be defined in the 'Two-dimensional tables' editor, and with a type 'Bridge Biery and Delleur arch' to store the values for the coefficient of discharge.

## Free surface flow

This tab contains additional geometrical parameters for the FHWA WSPRO and USBPR methods. When working with asymmetric openings, these parameters must be specified for the left and right side, respectively.

### *Use custom table*

When this option is unchecked, the simulation uses the default loss table for the related item. When checked, the simulation uses a user-defined table, which is selected in the corresponding field, using the ellipsis button. In this user-defined table, it is possible to add more rows and sometimes more columns, and edit the values.

For the FHWA WSPRO method, the following custom tables may be used:

- Base coefficient: for opening type I, the table must be defined in the 'Curves and relations' editor and with a type 'Bridge FHWA WSPRO base coef. type I'. For opening types II, III and IV, the table must be defined in the 'Two-dimensional tables' editor, respectively with type 'Bridge FHWA WSPRO base coef. type II', 'Bridge FHWA WSPRO base coef. type III' and 'Bridge FHWA WSPRO base coef. type IV' to store the values of the base coefficient  $C$ .
- Entrance rounding: the table must be defined in the 'Curves and relations' editor, and with a type 'Bridge FHWA WSPRO entrance'.
- Froude number: the table must be defined in the 'Curves and relations' editor, and with a type 'Bridge FHWA WSPRO Froude'.
- Average depth: the table must be defined in the 'Curves and relations' editor, and with a type 'Bridge FHWA WSPRO depth' to store the values of the parameter  $k_y$ .
- Abutment: the table must be defined in the 'Curves and relations' editor, and with a type 'Bridge FHWA WSPRO abutment' to store the values of the parameter  $k_x$ .
- Wingwalls: the table must be defined in the 'Curves and relations' editor, and with a type 'Bridge FHWA WSPRO wingwall'.

For the USBPR method, the following custom tables may be used:



- Base coefficient: the table must be defined in the 'Curves and relations' editor, and with a type 'Bridge USBPR base coefficient'.
- Velocity distribution coefficient: the table must be defined in the 'Two-dimensional tables' editor, and with a type 'Bridge USBPR velocity distribution' to store the values of the parameter Alpha2.

Please refer to the reference manual for descriptions of variables used in the tables for the various methods.

#### *Type (Base coefficient)*

Three types of openings are available with the USBPR method:

- 90° wingwall
- 45° wingwall
- Spillthrough

#### *Type (Entrance rounding)*

For opening type I with FHWA WSPRO method, two types of entrance rounding are available:

- Corner
- Wingwall.

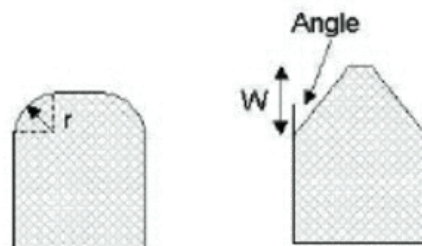

Figure 3.80 Rounding type for opening type I (Left: corner; Right: wingwall)

#### *Radius (Entrance rounding)*

Radius of the corner ( $r$ , in Figure 3.80 above).

#### *Width (Entrance rounding)*

Width of the wingwall ( $W$ , in Figure 3.80 above).

#### *Angle (Entrance rounding)*

Angle of the corner (Angle, in Figure 3.80 above).



### *Embankment slope*

The slope of the embankment for opening types II, III, and IV with FHWA WSPRO method. For example, use a value 2 for a 1:2 slope.

### *Angle (Wingwalls)*

Angle of the wingwall for opening type IV with FHWA WSPRO method.

## Submergence and overflow

Under the Submergence and overflow tab, it is possible to optionally include either submergence, or submergence and overflow.

These options are only available in combination with the Energy equation, FHWA WSPRO or USBPR method for free surface flow calculation.

### Submergence

#### *Method*

The method controls the equation applied to describe the submerged flow through the opening. The choice of method should be based on the assumptions for the different methods and the requirements of the modelling. The available methods are:

- FHWA WSPRO: the Federal Highway Administration (FHWA) WSPRO method for pressure flow is based on two orifice equation descriptions. One for situations when the orifice is submerged downstream and a modified equation for situations when only the upstream part of the orifice is submerged.
- Energy equation: the flow under the opening is determined through a standard backwater step method. The flow is assumed to be in the sub-critical range and thus the method may default to critical flow. Both contraction and expansion losses are taken into account.
- Culvert: a standard culvert description may be chosen for submergence flow, where the culvert is specified in the 'Culverts' editor. The culvert is only active if submergence occurs.

#### *Discharge coefficient*

The discharge coefficient in the FHWA submergence equation.

#### *Use custom table*

When this option is unchecked, the simulation uses the default table for coefficient of discharge. When checked, the simulation uses a user-defined table, which is selected in the corresponding field, using the ellipsis button.

The table must be defined in the 'Curves and relations' editor, and with a type 'Bridge FHWA WSPRO submergence'.



Please refer to the reference manual for descriptions of variables used in the table.

#### *Bridge soffit level*

The soffit (underside) level of the opening.

#### *Contraction loss*

The contraction loss coefficient.

#### *Expansion loss*

The expansion loss coefficient.

#### *Culvert*

The ID of the selected culvert to be used, from the list of valid structures in the 'Culverts' editor. The culvert must be located on the same river and the same chainage as the bridge.

### Overflow

#### *Method*

The method controls the equation applied to describe the flow over the bridge. The choice of method should be based on the assumptions for the different methods and the requirements of the modelling. The available methods are:

- FHWA WSPRO: the Federal Highway Administration (FHWA) WSPRO method is based on a weir equation taking tail water submergence into account through the use of a submergence coefficient. The method may be used for both gravel and paved surfaces.
- Energy equation: the flow over the bridge is determined through a standard backwater step method. The flow is assumed to be in the subcritical range and thus the method may default to critical flow.
- Weir: a standard weir description may be chosen for overflow, where the weir is specified in the 'Weirs' editor. The weir is only active if overflow occurs.

#### *Bridge deck level*

The deck (underside) level for the opening.

#### *Length*

The length of top of embankment in the flow direction.

#### *Use custom tables*

When this option is unchecked, the simulation uses the default tables for coefficients of discharge and for the submergence factor. When checked, the simulation uses user-defined tables, which are selected in the corresponding fields, using the ellipsis buttons.



The tables must be defined in the 'Curves and relations' editor. The table for discharge coef. #1 must have a type 'Bridge FHWA WSPRO overflow cf1'. The table for discharge coef. #2 must have a type 'Bridge FHWA WSPRO overflow cf2'. The table for the submergence factor must have a type 'Bridge FHWA WSPRO overflow kt'.

Please refer to the reference manual for descriptions of variables used in the tables.

### *Surface*

The surface of the top of the bridge, required when using default tables, and which can be of type:

- Paved
- Gravel.

### *Weir*

The ID of the selected weir to be used, from the list of valid structures in the 'Weirs' editor, from the river network. The weir must be located on the same river and the same chainage as the bridge.

## Cross sections

In the Cross sections tab, it is required to specify the geometry of the bridge opening, on both its upstream and its downstream side. The corresponding bridge's cross sections should describe the bottom of the opening as well as its lateral walls, and are used for the free surface flow calculation. When submergence and overflow are included, the levels of submergence and overflow are specified in the Submergence and overflow tab, and therefore don't have to be included in the bridge's cross sections.

The upstream and downstream bridge's cross sections are illustrated on Figure 6.29, representing a plan view of the bridge, respectively as sections 2 and 3. Cross sections 1 and 4 are the closest cross sections defined in the Cross sections editor.

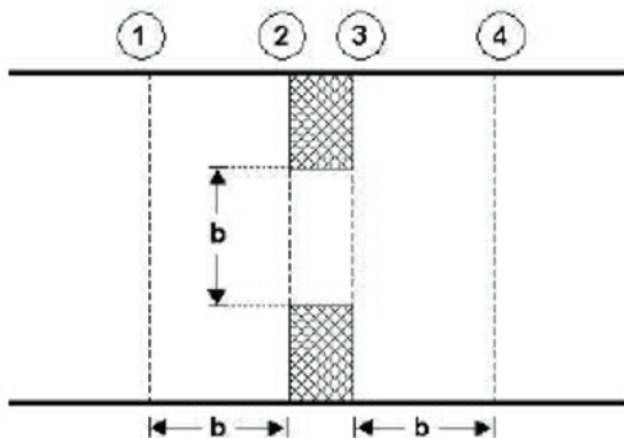

Figure 3.81 Location of upstream and downstream cross sections

The location of the cross sections outside the bridge (as defined in the Cross sections editor from the tree view) should be so that any potential contraction or expansion loss is taken into account. In other words, the optimal location is where the stream lines are parallel prior to a contraction and post a possible expansion. As a rule of thumb, the distance between the bridge and the cross sections should be in the order of one opening width.

#### Upstream section, free surface flow

The upstream cross section of the opening is defined in a table, which provides a list of points describing the topography along the lateral walls and the bottom of the opening.

The 'S' column provides the horizontal distance of each point along the cross section, from the left end of the cross section. Note that the S-values are compared to the S-values of the upstream cross section (defined in the 'Cross sections' editor), and it is therefore important that S-values are consistent between these cross sections.

The 'Z' column provides the elevation of the points.

The 'Roughness' column provides the relative resistance in the cross section point. A factor 1 corresponds to the resistance value specified in the General tab.

The 'Marker' column may optionally contain the following markers:

- 'Left extent': defines the left extent of the active part of the cross section used for the calculation. All points of the cross section located to the left of this marker are ignored. If this marker is not defined in the cross section, it is assumed that left extent corresponds to the first point in the table.



- 'Left abutment': defines the horizontal position of the bottom of the left wall of the opening.
- 'Right abutment': defines the horizontal position of the bottom of the right wall of the opening.
- 'Right extent': defines the right extent of the active part of the cross section used for the calculation. All points of the cross section located to the right of this marker are ignored. If this marker is not defined in the cross section, it is assumed that right extent corresponds to the last point in the table.

When markers 'Left abutment' and 'Right abutment' are defined in the cross section, it is assumed that the part of the cross section between these two markers corresponds to the natural river bed, and in this case the roughness applied between these markers is obtained from the upstream and downstream cross sections. If these markers are not defined, the roughness value specified in the General tab will be uniformly applied along the bridge's cross section.

The buttons above the table can be used to insert, delete and re-order lines in the table.

#### *Datum*

A datum value may be entered here. The datum is added to all Z values in the table. The datum is normally used for adjusting the levels of the cross sections such that they conform to a specific reference datum in the model area.

#### *Copy upstr. section*

The button 'Copy upstr. section' fills in the table, by copying the S, Z and roughness values from the first cross section located upstream of the bridge. This allows to easily obtain the geometry of the upstream cross section, and manually edit this cross section afterwards to describe the geometry of the bridge.

#### *Use custom sub-cross section*

When the main structure contains multiple openings, the entrance loss upstream and downstream of each opening is computed using a sub-part of the upstream cross section (defined in the 'Cross sections' editor), and not using the full width of the upstream cross section. The upstream sub-cross section represents the part of the cross section where the water flows towards the active opening.

When the option 'Use custom sub-cross section' is unchecked, the upstream sub-cross section is defined automatically, based on geometrical considerations only. When the option is checked, the position of the upstream sub-cross is manually defined between 'From S value' and 'To' S-value.





### *From S value*

This value represents the left horizontal extent of the upstream sub-cross section. This S value refers to the S value specified in the raw data table of the upstream cross section, defined in the Cross sections editor.

### *To S value*

This value represents the right horizontal extent of the upstream sub-cross section. This S value refers to the S value specified in the raw data table of the upstream cross section, defined in the Cross sections editor.

### *Downstream section, free surface flow*

The downstream cross section of the opening may either be defined as a copy of the upstream cross section of the bridge, in which case elevations are corrected using a longitudinal slope, or defined with its own table.

### *Cross section*

This controls the way the downstream cross section of the bridge is defined:

- Same as upstream: the downstream cross section of the bridge is defined with data from the upstream cross section, but with a correction of elevations to take the longitudinal slope into account.
- User-defined section: the downstream cross section of the bridge is defined in its own table. Please refer to the description of the table used for the upstream cross section for more details.

### *Slope*

The slope between the upstream and the downstream cross sections of the bridge.

### *Datum*

A datum value may be entered here when the downstream cross section of the bridge is defined in its own table. The datum is added to all Z values in this table. The datum is normally used for adjusting the levels of the cross sections such that they conform to a specific reference datum in the model area.

### *Copy downstr. section*

The button 'Copy downstr. section' fills in the table, by copying the S, Z and roughness values from the first cross section located downstream of the bridge. This allows to easily obtain the geometry of the downstream cross section, and manually edit this cross section afterwards to describe the geometry of the bridge.

### *Use default downstream sub-cross section*

When the main structure contains multiple openings, the exit loss downstream of each opening is computed using a sub-part of the downstream cross section (defined in the 'Cross sections' editor), and not using the full



width of the downstream cross section. The downstream sub-cross section represents the part of the cross section where the water flows from the active opening.

When the option 'Use custom sub-cross section' is unchecked, the downstream sub-cross section is defined automatically, based on geometrical considerations only. When the option is checked, the position of the downstream sub-cross is manually defined between 'From S value' and 'To' S-value.

#### *From S value*

This value represents the left horizontal extent of the downstream sub-cross section. This S value refers to the S value specified in the raw data table of the downstream cross section, defined in the Cross sections editor.

#### *To S value*

This value represents the right horizontal extent of the downstream sub-cross section. This S value refers to the S value specified in the raw data table of the downstream cross section, defined in the Cross sections editor.

## Plot

To help ensuring that the geometry of the bridge is properly defined, the bridge's cross sections are shown and are compared to its upstream and downstream cross sections. On this plot, the horizontal axis shows the X-coordinates from the upstream cross section. The downstream cross section is then shifted so that its marker 2 is aligned with the marker 2 from the upstream cross section. The bridge's cross sections are also centered around this marker 2, but can be moved horizontally using the value 'Horizontal offset from marker 2'.

Note that this horizontal offset value is only used for the visualization purpose and has no impact on the simulation.

### 3.6.4 Pumps

A pump controls the discharge on a river between two cross sections, either using a constant discharge or a relationship between its discharge and the upstream/downstream water level difference.



Pumps

Identification

ID RiverPump\_1 River ID River ... Insert

Apply Chainage 2391.429 [m] Delete

Attributes Description

Pump type Constant flow

Start level 48.51 [m]

Stop level 47.8 [m]

Acceleration Time 60 [sec]

Deceleration Time 60 [sec]

Constant flow 0.45 [m<sup>3</sup>/s]

Q-dH table ... Edit

ID ALL Clear Show selected Show data errors 1/1 rows, 0 selected

ID	Apply	River ID	Chainage [m]	Pump type	Start level [m]	Stop level [m]	Acceleration
1 RiverPump_1	<input checked="" type="checkbox"/>	River	2391.429	Constant flow	48.51	47.8	

Figure 3.82 The Pumps editor accessed via the River Network setup group

## Identification

The Identification group holds basic information on pumps structures.

### ID

Unique string identification for the pump.

### River ID

The ID of the river where the pump is located. The River ID is automatically registered if the pump is created via the Map. Use the button with an arrow, to select the location of the structure on the map: this will specify both the River ID and the Chainage of the structure.

### Chainage

Chainage at which the pump is located along the river.

### Apply

This check box allows the user to toggle the Active status of the pump on and off. The simulations will omit all pumps that are not active.

## Attributes

The general settings of the pumps are defined on the Attributes tab of the pumps editor (Figure 3.83).



Attributes	Description
Pump type	Constant flow
Start level	4.1 [m]
Stop level	2.6 [m]
Acceleration Time	1800 [sec]
Deceleration Time	3600 [sec]
Constant flow	51.5 [m <sup>3</sup> /s]
Q-dH table	... Edit

Figure 3.83 Attributes tab on the Pumps editor

### Pump type

The pump type is determined by the way its pump rate or discharge is defined:

- **Constant flow:** Pump discharge is fixed and independent of the local water head except for the start/stop control.
- **Q-DeltaH:** Pump discharge is controlled by a specified relationship between the discharge Q and the water level difference (dH).

### Start level

The pump will be activated when the upstream water level exceeds the Start level.

### Stop level

Water level below which the pump starts closing down

### Acceleration time

Duration for changing pump discharge from zero to full flow. The pump discharge is changed linearly in time.

### Deceleration time

Duration for changing pump discharge from full flow to zero. The pump discharge is changed linearly in time.

### Constant flow

The fixed discharge value, when the pump type is 'Constant flow'.

### Q-dH table

The selected table holding the relationship between the pump discharge Q and the upstream/downstream water level difference (dH). The table must be defined in the 'Curves and relations' editor, with a type 'Capacity Curve QdH'. Use the '...' button to select a table among the existing tables with a valid type. The discharge is determined through interpolated look up in the table.



Note: Extrapolation is not allowed. It is therefore recommended to add limit points to the Q-dH curve. See Figure 3.84.

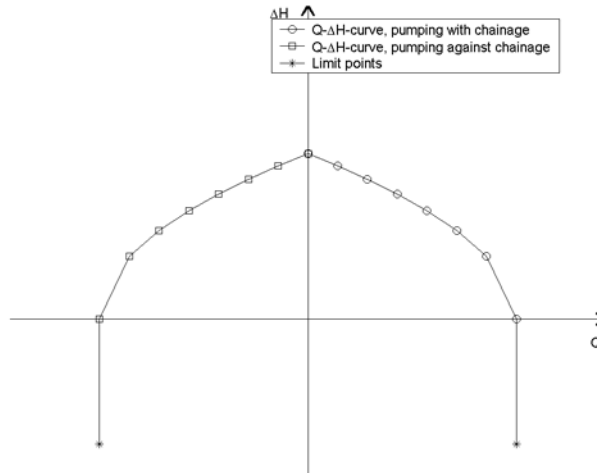

Figure 3.84 Q-dH curves for pumps

Note that a positive discharge  $Q$  is always interpreted as the pump pumping from upstream to downstream (i.e. from higher lying areas to a lower lying areas). Typically, this is from smaller chainage to higher chainage. If a negative flow direction is selected for the river containing the pump, positive discharge is still interpreted as pumping from upstream to downstream, but in this situation it means pumping from higher chainages to smaller chainages.

## Description

Use the Description tab to add free text descriptions for pumps (Figure 3.85). It offers options for providing model management information, as well as attributes for quick model data query.



The screenshot shows a software interface with two tabs: 'Attributes' and 'Description'. The 'Description' tab is active. It contains five input fields stacked vertically: 'Description', 'Data source', 'Asset ID', 'Status', and 'Network type'. The 'Status' and 'Network type' fields are dropdown menus. To the right of the 'Asset ID' field, there is a button labeled 'Add picture'.

Figure 3.85 The Description tab page on the Pumps editor

- **Description:** Free text description for the pump.
- **Data source:** Free text describing data source for pump data.
- **Status:** Project-defined status information that may be used for model build management or e.g. model data query. Pre-defined codes are contained in the Status Code editor (Figure 3.15) which may be accessed via the ellipsis button from the Status dropdown menu (see Figure 3.85).
- **Add picture:** Option for adding images associated with the pump.

### 3.6.5 Gates

Gates may be used whenever structure flow is to be regulated by the operation of a movable gate forming part of the structure. The Gates editor (Figure 3.86) contains the physical properties of the structures, while the rules regulating it are defined in the Control rules editor.

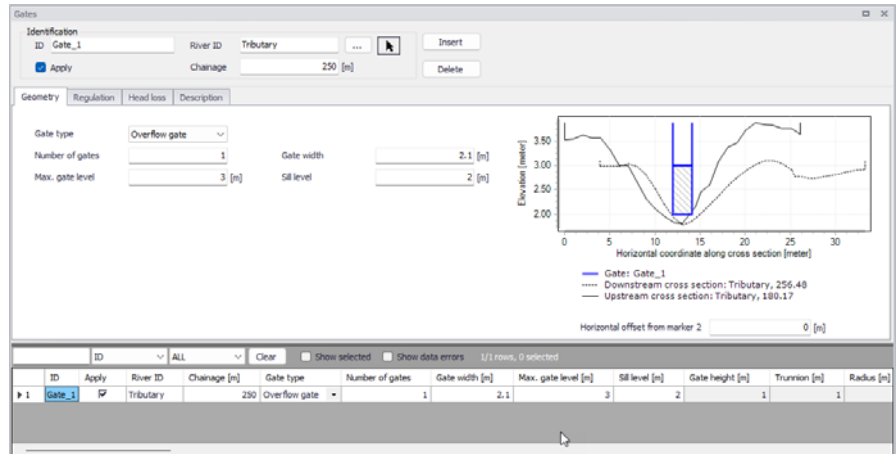

Figure 3.86 The Gates editor accessed via the River Network setup group

## Identification

The Identification group holds basic information on gates.

### ID

Unique string identification for the gate.

### River ID

The ID of the river branch where the gate is located. The River ID is automatically registered if the gate is created via the Map. Use the button with an arrow, to select the location of the structure on the map: this will specify both the River ID and the Chainage of the structure.

### Chainage

Chainage at which the gate is located.

### Apply

This check box allows the user to toggle the Active status of the gate on and off. The simulations will omit all gates that are not active.

## Geometry

Geometric properties for the gate are defined on the Geometry tab page of the gates editor (Figure 3.87).

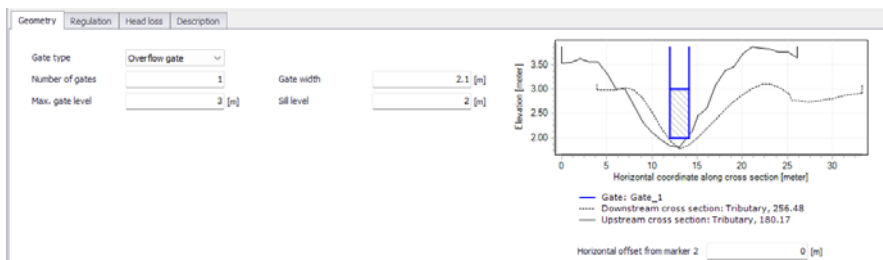

Figure 3.87 Geometry tab on the Gates editor

Define properties such as:

### Gate type

The following options are available to define the gate type:

- **Overflow gate:** This gate type corresponds to a variable crested weir.
- **Underflow gate:** This gate type corresponds to a vertical sluice gate.
- **Radial gate:** This gate type corresponds to a Tainter gate. In contrast to the other gate types a radial gate does not need any information about head loss factors. Instead a number of radial gate parameters must be entered, see the Flow parameters section.
- **Sluice gate:** This gate is physically the same as an underflow gate but instead of using the energy equation a set of flow formulas are applied, see the Flow parameters section.

### Number of gates

Number of parallel and identical gates. All these gates will inherit the same control rules and will therefore have the same gate level.

### Gate width

The width of the gate.

### Max. gate level

The highest possible gate level.

### Sill level

The level of the sill just upstream of the gate.

### Gate height

Parameter specified for radial gates and sluice gates. Height of the overflow crest above sill level when the gate is closed. See Figure 3.88 for radial gates.

### Trunnion

Parameter specified for radial gates only. Height of the center of gate circle above sill level, see Figure 3.88.





## Radius

Parameter specified for radial gates only. Radius of gate, see Figure 3.88.

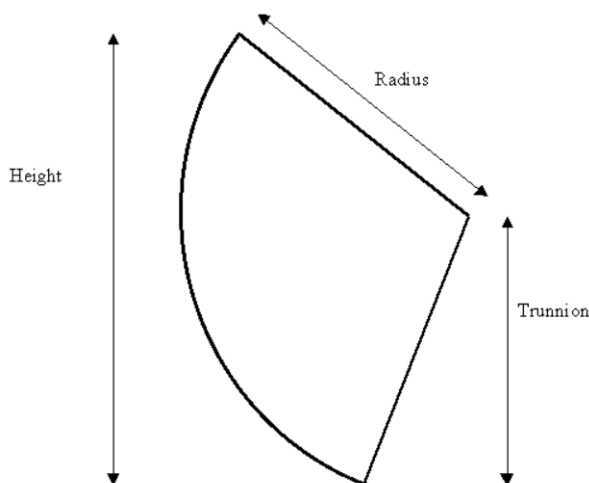

Figure 3.88 Definition of a radial gate

## Structure plot

To help ensuring that the geometry of the gate is properly defined, the gate's shape is shown and is compared to its upstream and downstream cross sections. On this plot, the horizontal axis shows the X-coordinates from the upstream cross section. The downstream cross section is then shifted so that its marker 2 is aligned with the marker 2 from the upstream cross section. The gate shape is also centered around this marker 2, but can be moved horizontally using the value 'Horizontal offset from marker 2'.

Note that this horizontal offset value is only used for the visualization purpose and has no impact on the simulation.

On the gate's shape, the area with hashes shows the area in which the gate can evolve, i.e. the area below the maximum gate level. It does not represent the actual / instantaneous gate level that will be computed during the simulation. For a radial gate, this is only the maximum level of the bottom of the gate, but the overflow will still be enabled in the simulation above this area with hashes.

## Regulation

Regulation settings (other than the control rules) of flows through the structure may be set in the Regulation tab page of the Gates editor (Figure 3.89).



Geometry	Regulation	Flow parameters	Description
Gate operation			
Max. speed	<input type="text" value="0.003"/>	[m/s]	
Initial gate level	<input type="text" value="112.1"/>	[m]	
Flow blockage			
<input type="checkbox"/> Apply flow factor	Flow factor	<input type="text" value="1"/>	

Figure 3.89 The Regulation tab page on the Gates editor

### Max. speed

Defines the maximum allowable change in gate level per time.

The maximum speed represents the physical maximum speed of the gate, and may be used to avoid very rapid changes in gate level. Such rapid changes could appear from some control rules but in case they are not realistic they would potentially create instabilities in the computation.

### Initial gate level

The value specified will be used as initial gate level at the beginning of the simulation.

### Apply flow factor

When this option is active, the discharge computed through the gate is multiplied by a flow factor. This factor's value is specified in the Flow factor field. The factor is a dimensionless factor, and a value of 1 means that no change is applied to the computed discharge. A value lower than 1 can typically be used to describe the reduction of the flow through the structure due to obstacles, like debris, restricting the flow area in the structure.

## Head Loss

Define head loss parameters for an overflow or underflow gate on the Head Loss tab page of the gates editor.

	Inflow	Outflow	Free overflow
Positive flow	<input type="text" value="0.5"/>	<input type="text" value="1"/>	<input type="text" value="1"/>
Negative flow	<input type="text" value="0.5"/>	<input type="text" value="1"/>	<input type="text" value="1"/>
Contraction coef.	<input type="text" value="0.63"/>		
Computational method	<input type="text" value="Energy equation"/>		

Figure 3.90 The Head Loss tab page of the Gates editor



Head loss variables are included in the calculation of the energy loss occurring for flows through hydraulic structures.

### Positive/Negative flow

Local head loss factors are defined for Inflow (entrance), Outflow (exit) and Free overflow (calibration factor). Different loss factors may be distinguished depending on the flow direction across the structure.

### Contraction coef.

This is the contraction coefficient used for underflow gates only.

### Computational method

Two computational methods are available:

- Energy equation: with this method, the flow through the structure is solved using the energy equation, in order to compute the discharge in the structure as a function of the head loss factors. The computed discharge is then applied at the calculation point. This is the preferred option in case there are big changes in cross sections before and after the structure, or if the flow area of the structure is much less than that of the river.
- Shallow water equation: with this method, the flow through the structure is solved adding a head loss term to the shallow water equation (Saint-Venant momentum equation), this term being a function of the head loss factors. With this method, the same equation is applied at structures' locations as at other regular calculation points (without structures). This ensures a continuity of the results between the upstream / downstream reaches and the structure, e.g. also including a bed friction between the upstream and downstream cross sections of the structure. Additionally, this method also enforces the use of velocity in upstream and downstream cross sections to compute the head loss, instead of using the velocity in the structure. This option is mainly designed for scenarios where the structure creates little or no head loss for low water levels, as e.g. for an overarching bridge. See the "Head loss mode" in the MIKE 1D reference manual, for more information.

Note: When the flow through the structure becomes supercritical, the applied method is always the Energy equation. Besides, the 'Shallow water equation' method cannot be applied for structures located on rivers of type 'Structure link'. When several structures exist at the same location, if any of them uses the Shallow water equation method, then all other structures at the same location will also apply the same equation no matter the selected method in their properties.

## Flow parameters

Flow parameters for radial gates and sluice gates are shown in the Flow parameters tab page of the Gates editor (Figure 3.91). The parameters to be specified are different for radial gates and for sluice gates.

Geometry	Regulation	Flow parameters	Description
Underflow factor	<input type="text" value="1"/>	Transition bottom	<input type="text" value="-0.152"/> [m]
Weir coefficient	<input type="text" value="1.5"/>	Transition depth	<input type="text" value="0.304"/> [m]
Weir exponent	<input type="text" value="1.838"/>		

Figure 3.91 The Flow parameters tab page for a radial gate

For radial gates, the structures are automatically divided into an underflow part and an overflow part. When specifying gate levels for a radial gate, the user should specify the level for the underflow part, i.e. the level of the bottom of the gate. The gate level for the overflow part is then calculated based on geometric considerations.

Flow through a radial gate is calculated as a function of the flow regime of the gate (either 'Free', 'Submerged' or 'Transition'). Free and Submerged flow regimes are calculated individually as described in 'Hydraulic Aspects - Radial Gates' in the MIKE 1D Reference Manual and flow in the transition zone is calculated as an interpolated value between the calculated Free and Submerged flows.

The following parameters are used for radial gates.

#### Underflow factor.

Discharge calibration factor. The factor is applied as a multiplication factor solely on the part of the discharge that flows below the radial gate (not applied to eventual overtopping gate flow).

#### Weir coefficient

Coefficient used in the calculation of eventual flow above the top of the radial gate (considered as weir flow above the top of the radial gate).

#### Weir exponent

Exponent used in the calculation of eventual flow above the top of the radial gate (considered as weir flow above the top of the radial gate).

#### Transition bottom

The Transition bottom parameter is an offset used to define the level where a free flow regime for the gate changes to a transition zone between free flow and submerged flow regime. It corresponds to  $y_{Tran, Bottom}$  as defined in 'Hydraulic Aspects - Radial Gates' in the MIKE 1D Reference Manual.

#### Transition depth

The transition depth parameter is used to define the depth (or height) of the transition zone between free flow and submerged flow regimes and consequently is used to define the level where the flow regime changes to submerged flow. Corresponds to  $y_{Tran, Depth}$  as defined in 'Hydraulic Aspects - Radial Gates' in the MIKE 1D Reference Manual.



For a sluice gate, the flow under the gate is divided into four flow regimes, the choice of which depends on the upstream and downstream water levels. The four flow regimes are:

- Controlled submerged
- Controlled free
- Uncontrolled submerged
- Uncontrolled free.

Additionally, the flow over the top of the sluice gate is taken into account when the water level upstream and/or downstream exceeds the gate level plus the gate height.

The following parameters are used for sluice gates, for the different flow regimes.

#### Coef. a

Coefficient a of the flow equation for the four different flow regimes.

#### Exp. b

Exponent b of the flow equation (it does not apply to the uncontrolled free flow).

#### High limit and low limit

High limit and low limit parameters used to smoothen the transitions between flow regimes (they do not apply to the uncontrolled free flow).

Please refer to the chapter 'Hydraulic Aspects - Sluice Gates' in the MIKE 1D Reference Manual for further details on the flow at sluice gates and to see the equations used in the computations.

## Description

Use the Description tab to add free text descriptions for gates (Figure 3.92). It offers options for providing model management information, as well as attributes for quick model data query.

Figure 3.92 The Description tab page on the Gates editor

- **Description:** Free text description for the gate.
- **Data source:** Free text describing data source for gate data.
- **Status:** Project-defined status information that may be used for model build management or e.g. model data query. Pre-defined codes are contained in the Status Code editor (Figure 3.15) which may be accessed via the ellipsis button from the Status dropdown menu (see Figure 3.92).
- **Add picture:** Option for adding images associated with the gate structure.

### 3.6.6 Direct discharges

A direct discharge structure is a structure which is not represented by its geometry, but instead directly by the discharge flowing through it. This type of structure may for example be used when a regulation is to be applied directly to the discharge, and not to e.g. a gate level.

The Direct discharges editor contains some attributes of the structures, while the control rules regulating it are defined in the Control rules editor.



Direct discharges

Identification

ID Discharge\_1 River ID River Chainage 2640.9 [m]

Apply

Attributes Description

Initial discharge 0 [m<sup>3</sup>/s] Max. discharge 15 [m<sup>3</sup>/s]

Maximum discharge change 0.015 [m<sup>3</sup>/s<sup>2</sup>] Number of structures 2

ID ALL Clear  Show selected  Show data errors 1/1 rows, 0 selected

ID	Apply	River ID	Chainage [m]	Initial discharge [m <sup>3</sup> /s]	Maximum discharge change [m <sup>3</sup> /s <sup>2</sup> ]	Number of s
1	<input checked="" type="checkbox"/>	River	2640.9	0	0.015	

Figure 3.93 The Direct discharges editor accessed via the River Network setup group

## Identification

The Identification group holds basic information on direct discharge structures.

### ID

Unique string identification for the structure.

### River ID

The ID of the river branch where the direct discharge structure is located. The River ID is automatically registered if the structure is created via the Map. Use the button with an arrow, to select the location of the structure on the map: this will specify both the River ID and the Chainage of the structure.

### Chainage

Chainage at which the direct discharge structure is located.

### Apply

This check box allows the user to toggle the Active status of the structure on and off. The simulations will omit all direct discharge structures that are not active.

## Attributes

The general settings of the direct discharge structures are defined on the Attributes tab of the direct discharges editor (Figure 3.94).



Attributes	Description
Initial discharge	<input type="text" value="5.3"/> [m <sup>3</sup> /s]
Max. discharge	<input type="text" value="12.5"/> [m <sup>3</sup> /s]
Maximum discharge change	<input type="text" value="0.002"/> [m <sup>3</sup> /s <sup>2</sup> ]
Number of structures	<input type="text" value="1"/>

Figure 3.94 Attributes tab on the Direct discharges editor

### Initial discharge

The value specified will be used as initial discharge at the beginning of the simulation.

### Max. discharge

This value is the maximum discharge through the structure. It is an absolute value acting both for positive and negative (reversed) flow directions.

### Max. discharge change

This variable defines the maximum allowable change in discharge per time. This variable may be used to avoid very rapid changes of discharge. Such rapid changes may happen with some control rules whereas they wouldn't be realistic and could create instabilities in the computation.

### Number of structures

Number of identical parallel discharge structures. When multiple structures are included, the control rules define the discharge through a single structure. This discharge is then multiplied by the number of structures.

## Description

Use the Description tab to add free text descriptions for direct discharge structures (Figure 3.95). It offers options for providing model management information, as well as attributes for quick model data query.

Attributes	Description
Description	<input type="text"/>
Data source	<input type="text"/>
Status	<input type="text" value="3: Imported"/> <input type="button" value="Add picture"/>

- 1: Model
- 2: GIS
- 3: Imported
- 4: Inserted
- 5: Modified
- 6: Calibrated
- 7: Verified
- 8: Erroneous
- 9: Unknown
- 10: Other
- 11: Interpolated
- 12: Need Site Inspection
- 13: As built drawings
- ...

Figure 3.95 The Description tab page on the Direct discharges editor





Description: Free text description for the direct discharge structure.

- **Data source:** Free text describing data source for direct discharge structure data.
- **Status:** Project-defined status information that may be used for model build management or e.g. model data query. Pre-defined codes are contained in the Status Code editor (Figure 3.15) which may be accessed via the ellipsis button from the Status dropdown menu (see Figure 3.95).
- **Add picture:** Option for adding images associated with the direct discharge structure.

### 3.6.7 Dambreak

A dambreak simulates the discharge through a breach, which geometry changes in time to describe the dynamic / progressive change of the breach's geometry. The temporal description of the breach geometry may be user-defined (controlled by time series) or computed using an erosion equation.

ID	Apply	River ID	Chainage [m]	Breach formula	Failure mode	Crest level before failure [m]	Crest length before failure [m]
Dambreak_1	<input checked="" type="checkbox"/>	Tributary	430	Energy equation	Time dependent	148.25	

Figure 3.96 The Dambreak editor accessed via the River Network setup group

A dambreak structure is described with two structures:

- A trapezoidal weir or circular opening, describing the breach. Its geometry (bottom width, crest width, bottom level, radius, etc.) changes in time to describe the temporal development of the breach.



- A horizontal weir, describing the overflow weir at the top of the dam. Its crest length is equal to its initial length minus the top width of the breach. Before the breach starts, its length is therefore equal to the normal length before failure. When the breach starts, its length decreases as much as the breach's top width increases, so that the total length remains unchanged.

Due to the highly unsteady nature of dambreak flood propagation, it is advisable that the river topography be described as accurately as possible through the use of as many cross-sections as necessary, particularly where the cross-sections are changing rapidly.

Another consideration is that the cross-sections themselves should extend as far as the highest modelled water level, which will normally be in excess of the highest recorded flood level. If the modelled water level exceeds the highest level in the cross-section for a particular location, MIKE+ will extrapolate the processed data of the cross section.



Note: When performing dambreak simulations, initial conditions should be set up with care, in order to obtain relevant results. Indeed, the discharge through the breach may highly depend on the downstream water level, therefore if the breach fails early in the simulation, the results may be influenced by the initial condition. It is advised to make sure that water levels and discharge throughout the domain, just before the failure, correctly represent the expected conditions. Additionally, initial conditions may create oscillations at the beginning of the simulation, which can unexpectedly trigger the failure of the dam in case the failure moment is controlled by the upstream water level. A hotstart initial condition may be used to achieve this.



Note: Your MIKE+ license must hold the MIKE+ Control module in order to authorize the use of dambreak structures.

## Identification

The Identification group holds basic information on the dambreak.

### ID

Unique string identification for the dambreak.

### River ID

The ID of the river where the dambreak is located. The River ID is automatically registered if the dambreak is created via the Map. Use the button with an arrow, to select the location of the structure on the map: this will specify both the River ID and the Chainage of the structure.

### Chainage

Chainage at which the dambreak is located along the river.



### Apply

This check box allows the user to toggle the Active status of the dambreak on and off. The simulations will omit all dambreak structures that are not active.

## General

The General tab is used for specifying the main properties of the dam and its break.

### Breach formula

The calculation of the dam break may be carried out using two different formulas. These will also affect the available options for geometry and failure mode. The breach formula available are:

- **Energy equation**
- **NWS DAMBRK equation** (from US National Weather Service)

### Failure mode

The development of the breach can take place in different ways. The failure mode of the structure is affected by the chosen breach formula.

When the energy equation is used to compute the dam break, the failure mode choices are:

- **Time dependent.** The development of the dam breach is specified by the user in terms of breach level, width and slope as functions of time (these are specified in the Breach development tab).
- **Erosion based.** The breach development is calculated by use of a sediment transport formula for which the parameters are specified in the Breach development tab.

If the NWS DAMBRK equation is selected the options are:

- **Breach failure.** The dam break initiates as a breach of the crest.
- **Piping failure.** The dam break initiates as a piping failure, the shape of the pipe being trapezoidal.

### Crest level before failure

The initial crest level of the dam before failure.

### Crest length before failure

The initial crest length (perpendicular to the flow) of the structure before failure.

The discharge through the dam is continuously computed through two separate structures, respectively describing the crest of the dam and the breach. After the failure, the width of the crest varies in time, and is equal to the Crest length before failure minus the instantaneous breach width. For this reason, the breach width cannot become longer than the Crest length before failure.



### Failure moment

The moment at which the dam failure commences can be defined in the following ways:

- **Hours after start.** The failure is specified to take place at a specified number of hours after the start of the simulation.
- **Date and time.** The failure time is specified as a specific date and time.
- **Reservoir water level.** The failure is specified to take place when the water level in the reservoir (assumed to be at the cross section immediately upstream of the dam) exceeds the specified level.
- **Control rule.** This option allows to use a user-defined rule to define the failure moment. This rule is defined in the Control rules menu, and may depend on e.g. instantaneous results or external data.

## Head loss

### Head Loss factors

The factors determining the energy loss occurring for flow over/through the hydraulic structure. These input parameters are only required for the energy equation method and must be specified for both Positive and Negative flow.

The inflow factor is a contraction loss factor. The outflow factor is an expansion loss factor. The Free overflow factor is a calibration factor used to adjust the head loss if extra phenomena should be included (a value of 1 means that no extra head loss is added).

### Flow blockage

When this option is active, the discharge computed through the dambreak is multiplied by a flow factor. This factor's value is specified in the Flow factor field. The factor is a dimensionless factor, and a value of 1 means that no change is applied to the computed discharge. A value lower than 1 can typically be used to describe the reduction of the flow through the structure due to obstacles, like debris, restricting the flow area in the structure.

## Breach development

This tab contains different parameters depending on the choice made for the breach formula and failure mode.

For the Erosion based failure mode, which can be selected when the Energy equation is used as breach formula, the parameters below are used. For this case, the vertical development of the breach is calculated using the Engelund-Hansen sediment transport formula. The breach's width is determined from the product of breach depth and the side erosion index specified by the user.



## Transversal dam geometry

### *Upstream slope*

Longitudinal slope (horizontal:vertical) of the upstream face of the dam structure.

### *Downstream slope*

Longitudinal slope (horizontal:vertical) of the downstream face of the of the dam structure.

### *Top width*

The top width of the dam crest, in the longitudinal direction.

## Material properties

### *Grain diameter*

Representative grain diameter of the dam core material.

### *Specific gravity*

Relative density of the dam core material. Usually ranging between 2.5 - 2.7.

### *Porosity*

Porosity of the dam core material. Usually ranging between 0.3 - 0.5.

### *Critical shear stress*

Critical shear stress of dam core material used for sediment transport estimation (Shields criteria). Usually ranging between 0.03 - 0.06.

### *Side erosion index*

Multiplication factor used to calculate breach width erosion rates from breach depth predictions.

## Limit of breach geometry

A limiting breach geometry must be specified using the following parameters:

- **Minimum bottom level.** Minimum bottom level of the trapezoidal shape describing the breach.
- **Maximum bottom width.** Maximum bottom width of the trapezoidal shape describing the breach.
- **Maximum breach slope.** Maximum transversal slope (horizontal: vertical) on the sides of the trapezoidal shape describing the breach.

## Initial failure

Type of initial failure. The failure of the dam can initially take place in two ways:

- **Breach failure:** a breach starting at the crest of the dam



- **Piping failure:** a piping failure through the dam.

For the 'Breach failure' type, the additional parameters below must be specified:

- **Initial level after failure.** The bottom level of the trapezoidal breach at the first time step after the failure moment.
- **Initial width after failure.** The bottom width of the trapezoidal breach at the first time step after the failure moment.

For the Piping failure type, the additional parameters below must be specified:

- **Starting level.** The pipe's center level at which piping failure begins to occur.
- **Initial diameter.** The diameter of the piping breach at the first time step after the failure moment.
- **Roughness.** Pipe roughness used to calculate the Darcy friction factor.
- **Collapse ratio (D/y).** When the ratio between the diameter of the pipe (D) and the distance from the top of the dam to the top of the pipe (y) is larger than the collapse ratio, the pipe collapses. After it has collapsed, the breach is modelled using a trapezoidal breach.
- **Volume loss ratio.** When the dam collapses some of the material may be carried out without depositing on the bed of the breach. The volume loss ratio is the fraction of the material to be washed out immediately after collapse. It ranges in the interval 0 - 1.
- **Calibration coefficient.** Calibration multiplication factor used to adjust the calculated change in pipe radius.

### Temporal description of geometry

In all the other cases, i.e. when the Energy equation is used with the 'Time dependent' failure mode, as well as when the NWS DAMBRK equation is selected as breach formula, the breach development is controlled by the parameters below.

#### *Breach bottom level*

The bottom level of the trapezoidal shape of the breach.

#### *Breach bottom width*

The bottom width of the trapezoidal shape of the breach.

#### *Transversal slope*

The transversal slope (horizontal:vertical) on both sides of the breach.



### *Pipe top level*

Upper level of the pipe. This option is available only if NWS piping failure is selected.

All these geometry features can be defined either as constant values or as time varying ones. For the latter it is necessary to select a dfs0 file, and select the appropriate item if the file contains more than one item.

### *Apply limiting section*

When using the Energy equation in combination with the 'Time dependent' failure mode, a limiting section can optionally be applied. If you select this option the development of the breach is limited (e.g. due to solid rock below the dam), otherwise it will be unlimited. The shape of the limitation must be specified as a cross section, in the 'Cross sections' editor. When this option is selected, the following parameters should also be specified.

### *River ID*

Name of the river in which the limiting cross section is defined, in the 'Cross sections' editor.

### *Topo ID*

Topo ID in which the limiting cross section is defined, in the 'Cross sections' editor.

### *Chainage*

Chainage of the limiting cross section, in the 'Cross sections' editor.

### *S-coordinate of breach's center*

The S-coordinate of the limiting cross section which is aligned with the breach centerline.

## Description

Use the Description tab to add free text descriptions for the dambreak (The Description tab on the Dambreak editor). It offers options for providing model management information, as well as attributes for quick model data query.

Figure 3.97 The Description tab on the Dambreak editor

- **Description:** Free text description for the dambreak.



- **Data source:** Free text describing data source for dambreak data.
- **Status:** Project-defined status information that may be used for model build management or e.g. model data query. Pre-defined codes are contained in the Status Code editor (Figure 3.15) which may be accessed via the ellipsis button from the Status dropdown menu (see Figure 3.77).
- **Add picture:** Option for adding images associated with the dambreak.

### Dambreak's reservoir description and auxiliary structures

To obtain an accurate description of the Dam reservoir storage characteristics, the reservoir can be modelled either as a single h-point in the model or as a branch with a number of cross sections correctly defining the topography and hence, volume characteristics along the reservoir.

In case the reservoir is represented by only one h-point, this will usually also correspond to the upstream boundary of the model where inflow hydrographs are specified. The reservoir is described with a storage node, the surface storage area of the dam is described as a function of the water level. The lowest water level should be somewhere below the final breach elevation of the dam, and should be associated with some finite flooded area.

#### 3.6.8 Energy losses

An energy loss is used to define losses associated with local flow obstructions such as sudden flow contractions or expansions and gradual or abrupt changes in the river alignment. Moreover, a user defined energy loss coefficient can be defined.





Energy losses

Identification

ID RiverEnergyLoss\_1 River ID River ... [Map Icon] Insert

Apply Chainage 540.5 [m] Delete

Energy losses Description

Abrupt change in alignment 0 [deg]

Gradual change in alignment 35 [deg]

Roughness value 0.03 [0]

Custom loss Positive flow 0 [0] Negative flow 0 [0]

Contraction loss 0 [0] 0 [0]

Expansion loss 0 [0] 0 [0]

Computational method Energy equation

ID ALL Clear Show selected Show data errors 1/1 rows, 0 selected

ID	Apply	River ID	Chainage [m]	Abrupt change in alignment	Abrupt change in alignment [deg]
1	<input checked="" type="checkbox"/>	River	540.5	<input type="checkbox"/>	

Figure 3.98 The Energy losses editor accessed via the River Network setup group

## Identification

The Identification group holds basic information on energy losses.

### ID

Unique string identification for the energy loss.

### River ID

The ID of the river where the energy loss is located. The River ID is automatically registered if the energy loss is created via the Map. Use the button with an arrow, to select the location of the structure on the map: this will specify both the River ID and the Chainage of the structure.

### Chainage

Chainage at which the energy loss is located along the river.

### Apply

This check box allows the user to toggle the Active status of the energy loss on and off. The simulations will omit all energy losses that are not active.



## Energy losses

At each specified energy loss location, a discharge grid point is inserted at simulation time. At each time step of the computation, the discharge at energy loss points is computed by use of the energy equation:

$$\Delta H = \zeta \frac{Q^2}{2gA^2} \quad (3.6)$$

in which  $\Delta H$  is the energy loss,  $g$  is the acceleration of gravity,  $Q$  is the discharge,  $A$  is the cross-sectional wetted area and  $\zeta$  denotes the energy loss coefficient.

Five different types of energy losses may be included in the simulation:

- Abrupt change in alignment
- Gradual change in alignment
- Custom loss
- Contraction loss
- Expansion loss

For an alignment change, the angular change in river alignment at the energy loss point must be specified. Additionally, for a gradual change the roughness coefficient must be defined.

For a custom loss, contraction loss or expansion loss, an energy loss coefficient must be defined for both positive and negative flows.

Besides, a computational method must be selected. Two options are available:

- Energy equation: with this method, the flow through the structure is solved using the energy equation, in order to compute the discharge in the structure as a function of the head loss factors. The computed discharge is then applied at the calculation point. This is the preferred option in case there are big changes in cross sections at an obstacle, or if the flow area alongside the obstacle is much less than that of the river.



- **Shallow water equation:** with this method, the flow through the structure is solved adding a head loss term to the shallow water equation (Saint-Venant momentum equation), this term being a function of the head loss factors. With this method, the same equation is applied at structures' locations as at other regular calculation points (without structures). This ensures a continuity of the results between the upstream / downstream reaches and the structure, e.g. also including a bed friction between the upstream and downstream cross sections of the structure. Additionally, this method also enforces the use of velocity in upstream and downstream cross sections to compute the head loss, instead of using the velocity in the structure. This option is mainly designed for scenarios where a structure creates little or no head loss for low water levels. See the "Head loss mode" in the MIKE 1D reference manual, for more information.

Note: When the flow through the structure becomes supercritical, the applied method is always the Energy equation. Besides, the 'Shallow water equation' method cannot be applied for structures located on rivers of type 'Structure link'. When several structures exist at the same location, if any of them uses the Shallow water equation method, then all other structures at the same location will also apply the same equation no matter the selected method in their properties.

## Description

Use the Description tab to add free text descriptions for energy losses (Figure 3.99). It offers options for providing model management information, as well as attributes for quick model data query.

The screenshot shows a software interface for editing energy losses. At the top, there are two tabs: 'Energy losses' and 'Description'. The 'Description' tab is active. Below the tabs, there are five input fields arranged vertically on the left side: 'Description' (a text box), 'Data source' (a text box), 'Asset ID' (a text box), 'Status' (a dropdown menu with a downward arrow), and 'Network type' (a dropdown menu with a downward arrow). To the right of these fields, there is a button labeled 'Add picture'.

Figure 3.99 The Description tab on the Energy losses editor

- **Description:** Free text description for the energy loss.
- **Data source:** Free text describing data source for energy loss data.
- **Status:** Project-defined status information that may be used for model build management or e.g. model data query. Pre-defined codes are contained in the Status Code editor (Figure 3.15) which may be accessed via the ellipsis button from the Status dropdown menu (see Figure 3.92)



- **Add picture:** Option for adding images associated with the energy loss.

### 3.6.9 Tabulated structures

Tabulated structures are structures regulated by a user-defined relationship between the discharge through the structure and the upstream and downstream water levels.

ID	Apply	River ID	Chainage [m]	Calculation mode	Q-h table
▶ 1	<input checked="" type="checkbox"/>	River	1245	Q as a function of h (upstream) and h (downstream)	Q_Curve_GateWest

Figure 3.100 The Tabulated structures editor accessed via the River Network setup group

## Identification

The Identification group holds basic information on tabulated structures.

### ID

Unique string identification for the tabulated structure.

### River ID

The ID of the river where the tabulated structure is located. The River ID is automatically registered if the tabulated structure is created via the Map. Use the button with an arrow, to select the location of the structure on the map: this will specify both the River ID and the Chainage of the structure.

### Chainage

Chainage at which the tabulated structure is located along the river.



## Apply

This check box allows the user to toggle the Active status of the tabulated structure on and off. The simulations will omit all tabulated structures that are not active.

## Attributes

### Calculation mode

Three calculation modes are available:

- **Q as a function of h (upstream) and h (downstream):** The discharge is given as a function of the upstream and downstream water levels. This relationship is defined in a table in the 'Two-dimensional tables' editor'. This table must have the type 'Tabulated Q (h(upstream), h(downstream))'.

In this table, the upstream water level 'h (upstream)' must be tabulated in the first column and must increase in the downward direction. The downstream water level 'h (downstream)' must be tabulated in the first row in the table and must increase in the right direction. Then the corresponding discharges must be tabulated. The discharge cannot increase in the right direction, and it cannot decrease in the downward direction.

- **h (upstream) as a function of h (downstream) and Q:** The upstream water level is given as a function of the discharge and downstream water level. This relationship is defined in a table in the 'Two-dimensional tables' editor'. This table must have the type 'Tabulated h(upstream) (Q, h(downstream))'.

In this table, the downstream water level 'h (downstream)' must be tabulated in the first column and must increase in the downward direction. The discharge must be tabulated in the first row in the table and must increase in the right direction. Then the corresponding upstream water levels must be tabulated and must increase in the right and the downward direction.

- **h (downstream) as a function of h (upstream) and Q:** The downstream water level is given as a function of the discharge and upstream water level. This relationship is defined in a table in the 'Two-dimensional tables' editor'. This table must have the type 'Tabulated (h(downstream) (Q, h(upstream)))'.

In this table, the upstream water level 'h (upstream)' must be tabulated in the first column and must increase in the downward direction. The discharge must be tabulated in the first row in the table and must increase in the right direction. Then the corresponding downstream water levels must be tabulated and must decrease in the right direction and increase in the downward direction.

## Tabulated data

### *Q-h table*

The selected table holding the relationship between the discharge in the structure and its upstream and downstream water levels, from the list of tables in the 'Two-dimensional tables' editor.

### *Discharge factor*

The discharge factor is multiplied to the discharge in the table.

### *Water level datum*

The water level datum is added to the upstream and downstream water levels in the table.

## Description

Use the Description tab to add free text descriptions for tabulated structures (Figure 3.101). It offers options for providing model management information, as well as attributes for quick model data query.

The screenshot shows a software interface with two tabs: 'Attributes' and 'Description'. The 'Description' tab is active. It contains five input fields: 'Description' (text), 'Data source' (text), 'Asset ID' (text), 'Status' (dropdown), and 'Network type' (dropdown). To the right of these fields is a button labeled 'Add picture'.

Figure 3.101 The Description tab on the Tabulated structures editor

- **Description:** Free text description for the tabulated structures.
- **Data source:** Free text describing data source for tabulated structures data.
- **Status:** Project-defined status information that may be used for model build management or e.g. model data query. Pre-defined codes are contained in the Status Code editor (Figure 3.15) which may be accessed via the ellipsis button from the Status dropdown menu (see Figure 3.101).
- **Add picture:** Option for adding images associated with the tabulated structure.



## 3.7 Storages

Storages describe any type of storage capacity, which can for example be a reservoir, a lake or a pond in a floodplain. The storage is described by a single calculation point during the simulation, represented by a relationship between the elevation and the storage volume or horizontal area. It is however represented by a polygon on the map, to illustrate the extent of the storage area.

A storage can be defined anywhere on the map, and should be connected to a river end. Connections are defined in the 'Rivers' editor, or using the 'River connection' feature layer on the map.

Storages can receive inflows from boundary conditions or from catchments. Refer to the respective chapters for more information.

Storages can be managed both graphically on the map and through the 'Storages' editor. The graphical editing on the map allows digitisation of the storage's extent using the tools Create, Edit, and Delete.

The Storages editor is used for editing the storage's attributes. It is also possible to insert new storages from the editor, in which case the new storages are given a schematised square shape.

ID	Apply	X coordinate [m]	Y coordinate [m]	Storage capacity type	Area at bottom elevation [m <sup>2</sup> ]
1 Southern reservoir	<input checked="" type="checkbox"/>	373419.58	8127671.129	Elevation - Area	

Figure 3.102 The Storages editor



Note: A storage can be connected to multiple rivers. A river can however support only one connection at each end, and it is therefore not possible to connect two storages to the same river end.



## Identification

The Storages editor has a general Identification group, containing information on catchment identifier and geographic location. Here the location is defined by the XY coordinates of the centroid of the storage polygon.

The 'Apply' check box allows the user to toggle the Active status of the storage on and off. The simulations will omit all storages that are not active.

## Geometry

The Geometry tab contains information to describe the storage capacity of the storage, which is to be derived from the topography within the storage area.

### Storage capacity type

The storage capacity type of the reservoir must be defined using the drop-down menu. There are two options:

- Elevation-area: the capacity is described using a table giving the horizontal area of the water surface as a function of the water level.
- Elevation-volume: the capacity is described using a table giving the stored water volume as a function of the water level. This Elevation-volume relationship is then converted to an Elevation-Area relationship during the simulation, using the following formula:

$$FIA_{i+1} = \left( \frac{\Delta V_{Table}}{\Delta H_{Table}} FIA_i \right) \cdot 2 \quad (3.7)$$

where:

- FIA: Storage area at level 'i' or 'i+1'
- $\Delta V_{Table}$  and  $\Delta H_{Table}$  are differences in volumes and levels respectively from values defined in the Elevation-Storage volume table.

### Area at bottom elevation

This is the area of the bottom of the storage (measured at the lowest level of the Elevation-volume relationship) which must be specified when the storage type is 'Elevation-volume'.

### Geometry table

This is the ID of the Elevation-area or Elevation-volume table describing the storage capacity, which must be defined in the 'Curves and relations' editor. For a storage type Elevation-area, the curve type must be 'Storage area capacity'. For a storage type Elevation-volume, the curve type must be 'Storage volume capacity'.





The Elevation-area relationship can be computed from a DEM, using the 'Compute storage from DEM tool'.

## Description

The Description tab allows the user to provide additional information for the storage.

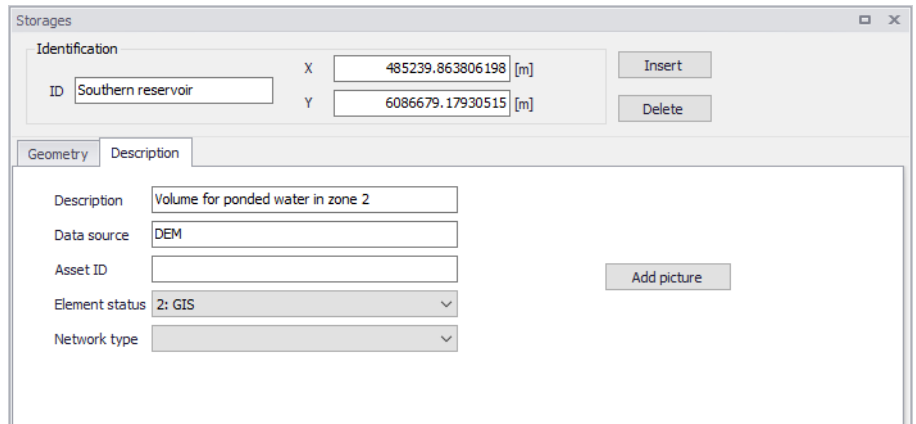

Figure 3.103 The Description tab from the Storages editor

## Connection

To create a connection to a river, go to the Rivers editor. In the 'Connections' group, click the button with an arrow to select a storage on the map, or the '...' button to select the storage from a list. This latter list is filtered by type of supported features, so selecting 'Storages' will show the list of storages which can be used.

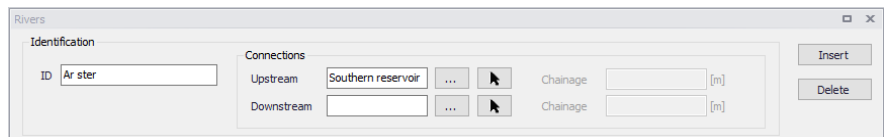

Figure 3.104 Connection to a storage defined in the Rivers editor

## 3.8 River Tools

A number of tools for river data processing are available in the 'River network' tab of the ribbon, in the 'Rivers toolbox' group.



Figure 3.105 The river data processing tools

Tools for creating, editing, importing and exporting cross sections are also accessible from the 'Cross sections' editor. Refer to Tools and Plugins for related descriptions.

### 3.8.1 Trace rivers from DEM tool

It is possible to automatically draw (trace) a river line using the elevation data from a DEM. From a start point (upstream) defined by the user on the map, the tool searches for the highest slope to find the direction of the flow i.e. the direction of the river line. This procedure is applied iteratively to find the river direction from cell to cell within the DEM extent.

While the tracing tool is active, moving the cursor over the map will automatically display a preview of the river that would be traced starting from the cursor position. When satisfied with the preview, click on the map to actually create the river.

The river will stop either when it reaches the border of the DEM or when it meets another existing river, in which case a connection to this river will also be created by the tool. It is possible to manually edit the river line afterwards, if necessary.

It is possible to include all elevation data (cells) from the DEM in the analysis, or include only a subset of the data. Using only a subset is especially relevant when the input DEM file is big. In that case, using only a subset can speed up the analysis. It is recommended that the size of the DEM should not exceed 25 million pixels. To use only a subset of the data, it is possible to reduce the spatial extent being analyzed and/or resample the data.

#### DEM source layer

Select from the list the DEM file to be used for the analysis. The tool supports DEM files with DHI format .dfs2, Esri text file format (.asc, .txt) or GeoTIFF (.tif, .tiff). The list initially shows the supported files already added to the map. If the file is not already available in the list, click the '...' button, select the file type and select the file.

Rotated grids are not supported, i.e. the Y axis of the DEM grid must be aligned with the North direction.

#### Spatial extent

Two options are available:



- Use whole DEM: the entire extent of the DEM will be included in the analysis.
- Use DEM only inside digitized area: this option allows defining a reduced extent covered by the DEM, from the map. Click the 'Digitize' button to draw on the map a rectangle defining the reduced extent. Once the area is finally defined, right-click on the map to stop the digitization. To edit the reduced area afterwards, use the 'Edit' button and then click and drag the symbols on the map to resize the rectangular area or move it on the map. Right-click on the map to stop editing.

### Resampling

Resampling requires specification of a resampling factor. If a resampling factor of 2 is used, then the minimum elevation of a 2x2 set of pixels is assigned to one new pixel with the same area as the 2x2 set. A resampling factor of 3 assigns the minimum value of a 3x3 pixel set to one new pixel with the same area as the 3x3 set, and so on.

### Number of pixels

This group shows for information the number of pixels in the source DEM, as well as the final number of pixels actually used in the analysis. They are both provided as number along the X axis and along the Y axis respectively. The final number of pixels is reduced by the spatial extent of the analysis when using the option 'Use DEM only inside digitized area', and is divided by the value of the resampling factor.



Note: many DEMs contain inaccuracies because of their resolution or artifacts resulting from the method of creation. When tracing rivers from a DEM, you may find some unexpected results. This can especially happen in flat areas where DEMs may not have the vertical resolution to correctly trace the rivers. Manual adjustments of the river lines may be necessary after the automatic tracing.



Note: in many digital elevation models, all pixels in lakes or other areas with ponded water have undefined (or blank) pixel values. When this situation occurs, all internal areas with undefined values are handled as a local depression. When a traced river is added, an artificial channel will be traced through the depression along the shortest path between the upstream and downstream ends. For example, if a lake is represented in a DEM as an undefined area, then an artificial flow path will be created through the lake along the shortest path to the outlet.

## 3.8.2 Compute storage from DEM tool

The storage capacity (Elevation-area relationship) can be computed for reservoirs, lakes, ponds, etc. and can be used as input definition for storage elements in the river network. The storage capacity is calculated using elevations from a DEM and spatial extents from the storage polygons on the map. The tool will automatically extract the area at different elevations for



each storage, and assign the obtained table (relationship) to the relevant storage.

Horizontal storage areas are calculated at regular vertical intervals. The lowest and highest elevations correspond respectively to the lowest and highest elevations from the DEM within the polygon. The intermediate elevations are controlled by the user-defined number of intervals, and are distributed evenly.



Note: Applying the tool to storages for which a geometry table is already applied will update them with a new geometry table.

### DEM layer

This is the source DEM used to estimate the storage capacity within the polygons. If valid DEMs are already loaded on the map, they can be selected from the drop-down list. The '...' button can be used to load a new DEM file.

### No of intervals in geometry table

This controls the number of elevations which will be obtained in the Elevation-area table.

### Input selection

The tool can process either:

- All storages: an Elevation-area relationship will be computed for each storage element in the model setup.
- Storages from selection on the map: an Elevation-area relationship will be computed only for the currently selected storages.
- Single storage: an Elevation-area relationship will be computed only for the selected storage.

### Configuration

- Open: loads the settings from a file created during a previous use of the tool.
- Save: saves the current settings in the tool to a file for later re-use.

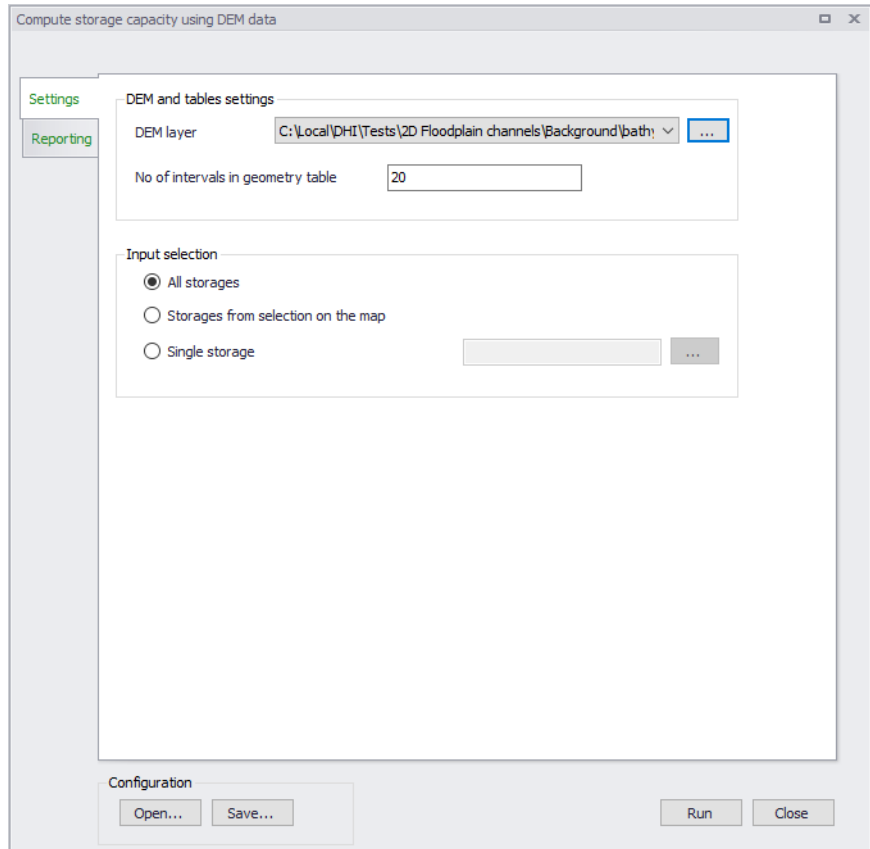

Figure 3.106 The Compute storage from DEM tool





## 4 Rainfall-Runoff Modelling

MIKE+ provides a versatile set of tools and computational models for modelling surface storm runoff and infiltration on urban and semi-rural catchments. The User can quickly prepare a precipitation-runoff model setup of desired level of detail (in terms of spatial discretization and input data) and use the computed runoff as a load to the collection network.

This Chapter provides a comprehensive guide for the preparation of hydrological models.

Modelling of urban storm runoff and infiltration requires understanding of information requirements and the involved processes. This understanding is supported by the illustration in Figure 4.1. Note that MIKE+ can model rain-fall-dependent infiltration (RDI). This is specifically discussed within the Parameters RDI section, and is not visually represented in Figure 4.1.

Although runoff computation and its subsequent use as a network load are, in principle, two distinct steps in the modelling process, MIKE+ has the facility to simulate the two processes simultaneously.

Runoff modelling engages the following:

- Catchments
- Optionally (only if network computations will follow), definition of the catchment connection, i.e. specification of the point of runoff inflow into the network.
- Definition of the hydrological models
- Precipitation (optionally, temperature and evapotranspiration)
- Runoff computations

The runoff is typically used as a hydraulic load to the collection network. This requires:

- Declaration of the computed runoff as a network hydraulic load
- Execution of the network computation.

Runoff and hydrodynamic network computations are run simultaneously in MIKE+. Nevertheless, they can also be launched in two distinct steps, if needed.

Furthermore, an important part of successful modelling is related to model calibration and verification, which ensure that the computed results fit reasonably well with the flow observations. The calibration and verification are important engineering activities in the modelling process, and they must be paid due attention.

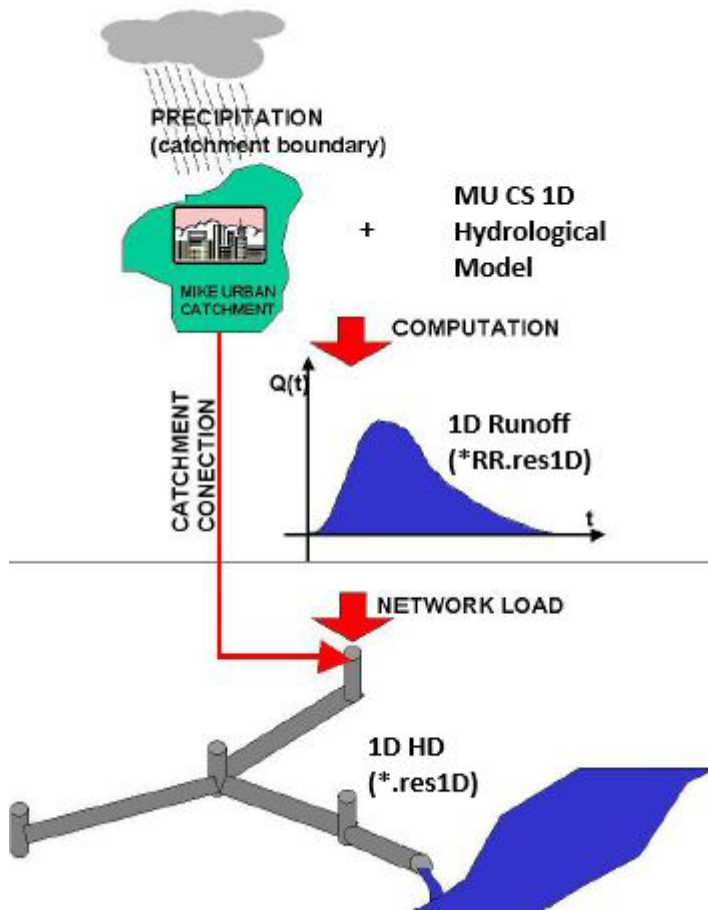

Figure 4.1 Illustrated flow of information in hydrological modelling

## 4.1 Catchments

Catchments are essential for any hydrological model. MIKE+ catchments are geographical polygon features which represent hydrological urban catchments or wastewater drainage areas. As such, catchments may be used for hydrological modeling or as wastewater sources.

In the context of hydrological modelling, MIKE+ catchments are treated as hydrological units where storm runoff and infiltration are generated based on a single set of model parameters and input data. Catchments represent the level of spatial discretization of the hydrological model.

Catchments are featured as a single data layer in MIKE+. After the definition of the catchments' connections to a model network, the catchments become a source of loads for a network model.





Catchments can be managed both graphically on the map and through the Catchments Editor. The two modes complement each other, and efficient management of catchment data can be achieved through joint application of both modes.

The graphical mode (i.e. Edit Features functionality) allows digitisation of catchment extent by tools like Create, Edit, Delete, and Split. Descriptions of graphical catchment tools are found in the Model Manager User Guide.

The Catchments Editor is used for:

- Editing catchment attributes. It is possible to insert catchments through the Editor; these are given a schematised quadratic shape.
- Editing connections to model networks and hydrological data for Rainfall-Runoff models.
- Editing catchment hydrological model attributes. It is possible to edit catchment attributes in relation to various hydrological runoff models available in MIKE+.

The Catchments Editor can be accessed via Catchments\Catchments.

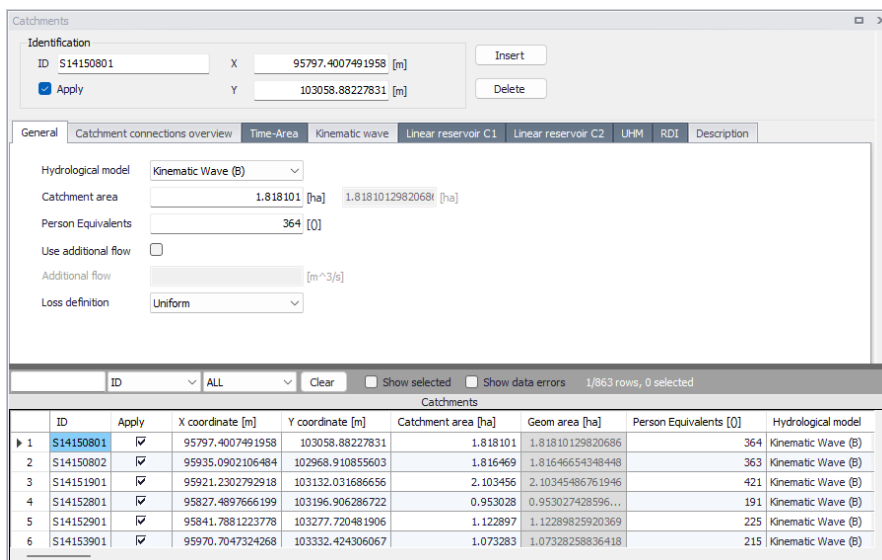

Figure 4.2 The Catchments Editor

The Catchments Editor has a general Identification Group containing information on catchment identifier and geographic location. The 'Apply' check box allows the user to toggle the Active status of the catchment on and off. The simulations will omit all catchments that are not active.

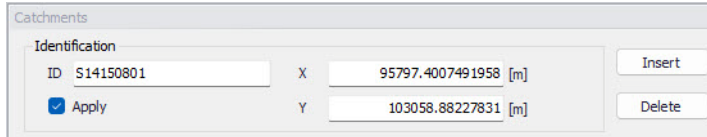

Figure 4.3 The Catchments Editor Identification Group

Table 4.1 Overview of the Catchments Editor Identification Group attributes (Table msm\_Catchment)

Edit field	Description	Usage	Attribute Table Field
ID	Unique catchment identifier	Yes	MUID
X	X coordinate of the catchment geometry centroid	Calculated (read-only)	-Derived-
Y	Y coordinate of the catchment geometry centroid	Calculated (read-only)	-Derived-
Apply	This check box allows to toggle the Active status of the catchment on and off. The simulations will omit all catchments that are not active.	Yes	Enabled

Other catchment attributes related to hydrological modelling and connections to model networks are organized in Tabs within the Catchments Editor and are described in succeeding Sections.

### 4.1.1 General

General catchment attributes related to geometry and Person Equivalents are specified in the 'General' tab of the Catchments Editor. Optionally, land use of the catchment's surface can also be specified in this tab.

In MIKE+, the geographical extent of a catchment is determined by the catchment polygon perimeter. MIKE+ provides information on the total catchment area based on polygon geometry.



In some cases, the geographical boundaries of a catchment do not coincide with the actual drainage area. A catchment extent may be defined based on some administrative division, while the drainage network is present only in some parts of the catchment. In such cases, the User may specify the Catchment Area value, which overwrites the actual geometric area in all hydrological computations.

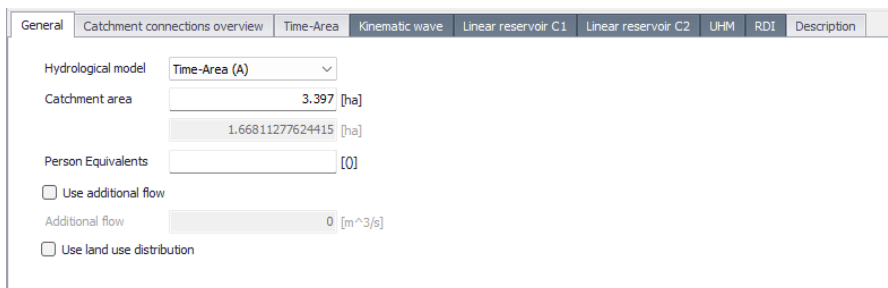

Figure 4.4 The General tab of the Catchments editor

A number of person equivalents may also be specified for the catchment, which will be used to compute the wastewater load on the catchment.

An optional additional flow can also be applied. It acts as a constant flow added to the computed catchment runoff during the simulation, if 'Use additional flow' is active.

Finally, the definition of land uses over the catchment may be activated from the 'Use land use distribution' option. This option allows defining local parameters within the catchment as a function of e.g. the surface coverage type. When this option is inactive, all parameters for the catchment simulation are defined in the tab corresponding to the selected hydrological model. When this option is active, an extra table must be filled with information about the description of each land use on the catchment. Land use definitions may be of two types:

- For hydrological models Time-Area (A), Kinematic wave (B), Linear Reservoir (C1) or Linear Reservoir (C2), the specification of the land use controls the local loss and infiltration settings, and is defined in the 'Land uses' editor. The computation of the runoff dynamics is instead performed at the catchment level, using the sum of runoffs from all land uses on the catchment, using the select hydrological model's method.
- For the RDI hydrological model, a land use is specified using a RDI parameter set (see Parameters RDI (p. 189)). Each RDI land use is simulated independently from other land uses: its resulting flow time series are simply summed up with flows from other land uses

The buttons next to the table are used to add or remove new land use types to the catchment. For each land use type, a contributing area (expressed as a



percentage of the catchment area) must be specified. The fields on the right of the table present the land use settings, for information (except for RDI land use type).

The percentage of the catchment area not contributing to the runoff is presented below the table. It represents the remainder of the catchment, not covered by the land uses, and therefore not generating runoff.

The approach based on land use is not available for the UHM hydrological model.

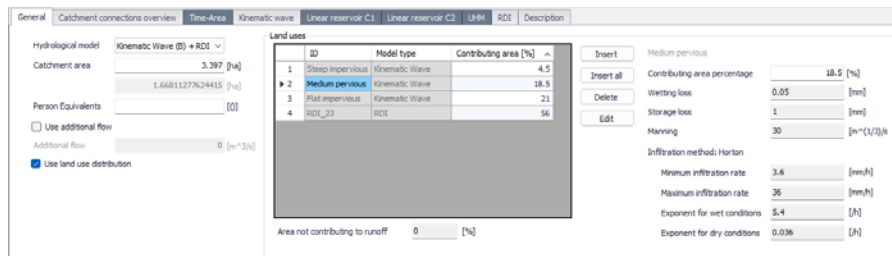

Figure 4.5 Definition of the land use on the catchment

Table 4.2 Overview of the Catchments Editor Geometry attributes (Table msm\_ - Catchment)

Edit field	Description	Usage	Attribute Table Field
Hydrological Model	Dropdown menu for selecting the hydrological runoff model to use for a catchment	Yes	HydrologicalModelNo
Catchment Area	The catchment area of relevance for the project	Optional	Area
(Geom. Area)	Program-calculated geometric area of the catchment polygon	Calculated (read-only)	-Derived-
Person Equivalents	Unit per capita loading for the catchment	Yes, Used as a method for wastewater load definition	Persons



Table 4.2 Overview of the Catchments Editor Geometry attributes (Table msm\_Catchment)

Edit field	Description	Usage	Attribute Table Field
Use additional flow	Option to include or exclude constant additional flow on the catchment	Optional	AddFlowNo
Additional Flow	Amount of constant additional flow	Optional	AddFlow
Use land use definition	Selection between uniform description of the catchment, or parameters distributed depending on the land use.	Yes	LossDefinition
Land use ID	Reference to a land use ID, as defined in the 'Land uses' editor, or to a RDI parameters ID, depending on the selected type of hydrological model.	Yes, If applying land use definition	LandUseID
Land use contributing area	Percentage of the catchment area covered by the corresponding land use.	Yes, If applying land use based loss definition	LandUseContrib

### 4.1.2 Description

The Catchments Editor Description Tab allows the User to provide additional information for a catchment record.

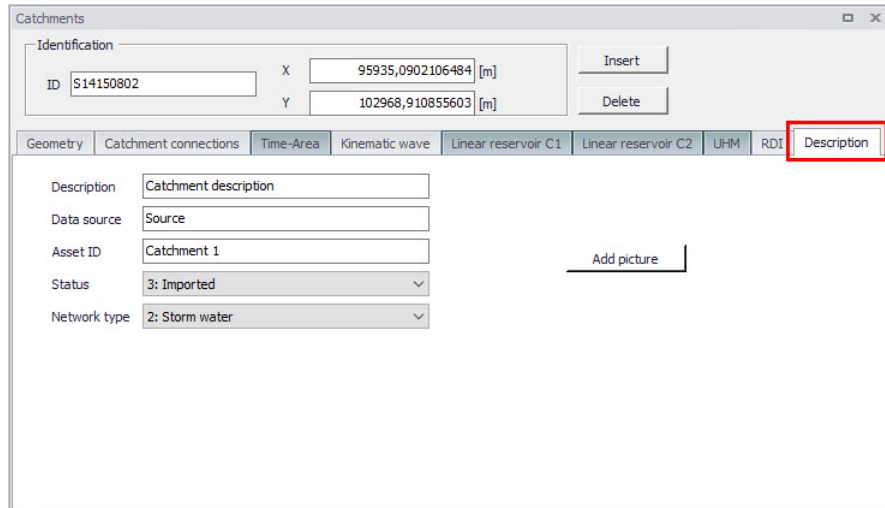

Figure 4.6 The Catchments Editor Description Tab

Table 4.3 The Catchments Editor Description Tab attributes (Table msm\_Catchment)

Edit field	Description	Usage	Attribute Table Field
Description	Free text description related to the catchment	Optional	Description
Data source	Reference to an external data source (e.g. table ID) from where the record was taken	Optional	DataSource
Asset ID	Reference to an ID used in external data sources	Optional	AssetName
Status	Data status for the record for keeping track of information source	Optional	Element_S



Table 4.3 The Catchments Editor Description Tab attributes (Table msm\_Catchment)

Edit field	Description	Usage	Attribute Table Field
Network Type	Attributes the catchment to a certain type of network. Used in cases where different network types are in the same project.	Optional	NetTypeNo
Add picture button	Facility for defining an image file for the catchment record. Accepts .PNG, .JPG, and .BMP image files.	Optional	-

## 4.2 Hydrological Models

Catchment records include information related to hydrological modelling. Such information is shown in separate tabs: one tab for each model.

Hydrological models for catchments include two distinct classes of models:

- **Surface runoff model:** These are the most common types in urban runoff analysis. The common characteristic of all the models in this class is that only surface runoff is computed. This implies discontinuous runoff hydrographs where flow starts as a result of rainfall and reduces to zero again after the end of rainfall. As such, these models are suitable for relatively densely urbanized catchments with dominant amount of runoff generated on impervious surfaces, and for single-event analyses (e.g. design rainfall of certain recurrence interval). These models fail to provide realistic results in dominantly rural catchments and for long-term analyses involving multi-event rainfall series.
- **Continuous hydrological models:** These models treat the precipitation volume balance without any truncation through complex concepts. As a result, the generated runoff includes both the overland and subsurface runoff components. Due to longer time scales involved, the runoff hydrographs appear practically continuous. An important property of continuous hydrological models is hydrological memory, i.e. the ability to simulate the catchment reaction to certain rainfall dependent on previous rainfalls. This type of model is essential for any long-term analysis and for dominantly rural catchments. On the other hand, these models are usually incapable of simulating extremely fast response of heavily impermeable urban catchments.



MIKE+ includes a series of surface runoff models and one continuous hydrological model. The surface runoff models available are:

- Time-Area Method (A)
- Kinematic Wave (B)
- Linear Reservoir (C1 and C2)
- Unit Hydrograph Method (UHM)

The continuous hydrological model included is Rainfall Dependent Infiltration (RDI).

Any of the surface runoff models can be used on their own, or in combination with RDI. When a surface runoff model is combined to RDI, the simulation will compute the runoff for each method (surface runoff model and RDI) separately as if they were different catchment, and will then sum the runoff of the surface runoff model and RDI model.

Combining different models for individual catchments in one runoff computation is also possible in MIKE+.

Detailed descriptions of the models are available in the following Sections and in the MIKE 1D Reference Manual.

#### 4.2.1 Time-Area Method (A)

The Time-Area Method is a simple surface runoff model with minimum data requirements. The runoff computation is based on a simple treatment of hydrological losses and the runoff routing by the so called Time-Area curve. Technical details on the method can be found in the MIKE 1D Reference Manual.

#### Model Data

A full overview of the editor fields and corresponding attributes is provided in the Table 4.4.



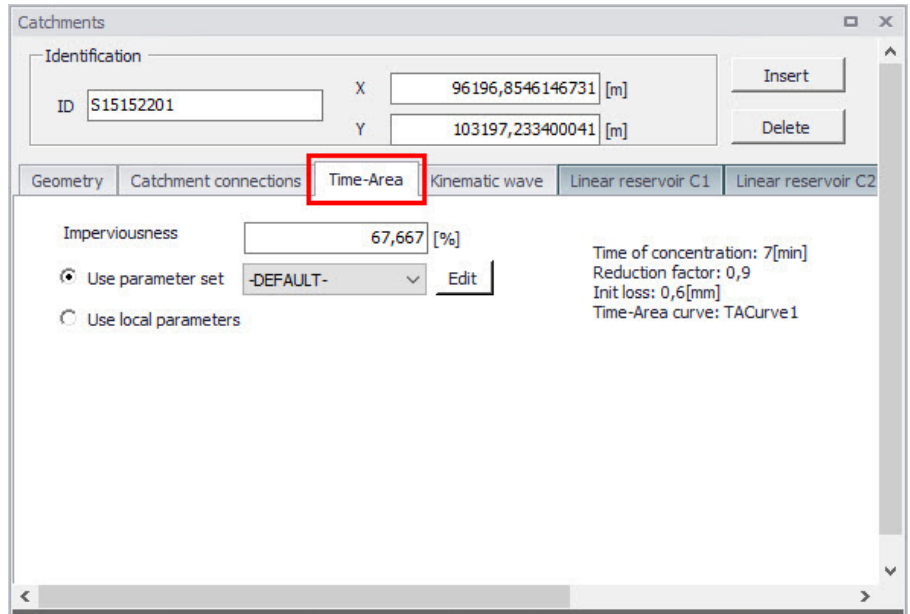

Figure 4.7 The Time-Area Model Tab

Table 4.4 Overview of the Time-Area Model attributes (Table msm\_Catchment)

Edit field	Description	Used or required by simulations	Field name in datastructure
Imperviousness	Impervious catchment area, as percent of the actual model area	Yes	ModelAImpArea
Use Parameter Set	Reference to a set of model parameters to be used for the current catchment	Yes	ModelAParAID
Use Local Parameters	Allows for local use of individual parameters	Optional	ModelALocalNo

### Parameters Time-Area

The Time-Area model uses several parameters. For practical reasons, these parameters have been grouped in parameter sets, which can be associated with certain catchments. This means the entire model setup can be established with a very small amount of information, while still allowing for full spa-



tial variation of model parameters for individual catchments through the application of local values.

New parameter sets can be inserted and values of individual parameters can be edited in the Parameters Time-Area Editor.

MIKE+ comes with a Default parameter set (-DEFAULT-). The User can insert any number of parameter sets and edit them as needed.

ID	Red Factor [0]	Init Loss [mm]	Conc Time [min]	TA Method	TA Cu
▶ 1 -DEFAULT-	0,9	0,6	7	Time-Area Curve No.	

Figure 4.8 The Time-Area Parameter Sets Editor (Catchments|Parameters Time-Area)

A full overview of the editor fields and corresponding database attributes is provided in the Table 4.5.



Table 4.5 Overview of the Time-Area Parameter Set Database attributes (Table msm\_HParA)

Edit field	Description	Used or required by simulations	Field name in datastructure
Parameter Set ID	Parameter set identifier	Yes	MUID
Time of Concentration	Concentration time	Yes	ConcTime
Initial Loss	Initial loss (wetting, interception, local depressions...)	Yes	InitLoss
Reduction Factor	Hydrological reduction factor	Yes	RedFactor
Time-Area curve/coefficient radio buttons	Switch for use of predefined tabulated T-A curves or analytically computed T-A relation	Yes	TAMethodNo
Time-Area Curve	Predefined T-A curve ID	Optional, alternates with TACoeff	TACurveID
Time-Area Coeff.	Value of the analytical T-A curve coefficient	Optional, alternates with TACurveID	TACoeff

## Time-Area Curve Editor

The Time-Area model uses (except if analytical curve is applied) predefined tabulated time-area curves. A Time-Area curve represents the contributing part of the catchment surface as a function of time. Implicitly, the Time-Area curve accounts for the shape of the catchment in relation to the outlet point.

MIKE+ comes with three Default Time-Area curves: TACurve1, TACurve2, and TACurve3, applicable for rectangular, divergent and convergent catchments, respectively (see the figures below).

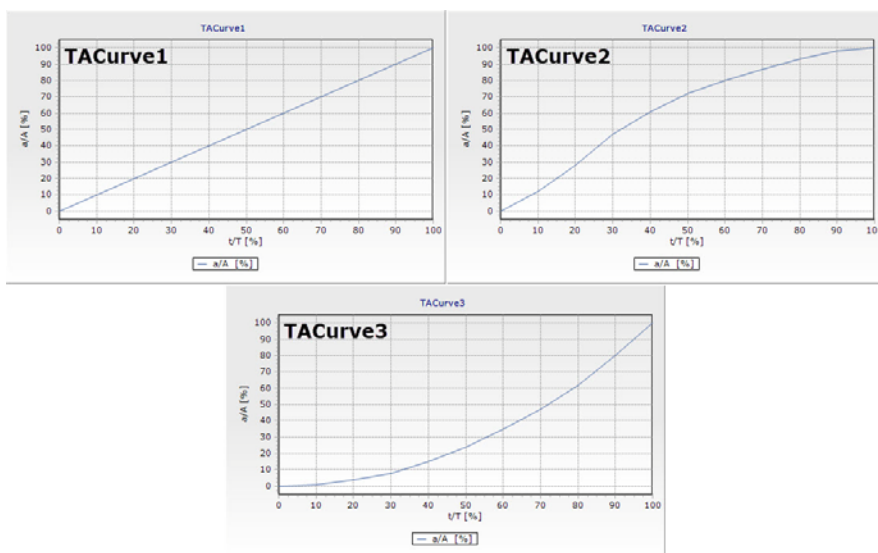

Figure 4.9 Three Default Time-Area curves

You can define any number of custom Time-Area curves. These can be inserted and edited in the editor for Curves and relations (Tables|Curves and Relations). Each Time-Area table must start with a pair of values (0,0) and must end with a pair of values representing the whole (per Default, MIKE+ maintains T-A curves in percent (%), i.e. the last pair of values in the table must be (100,100).

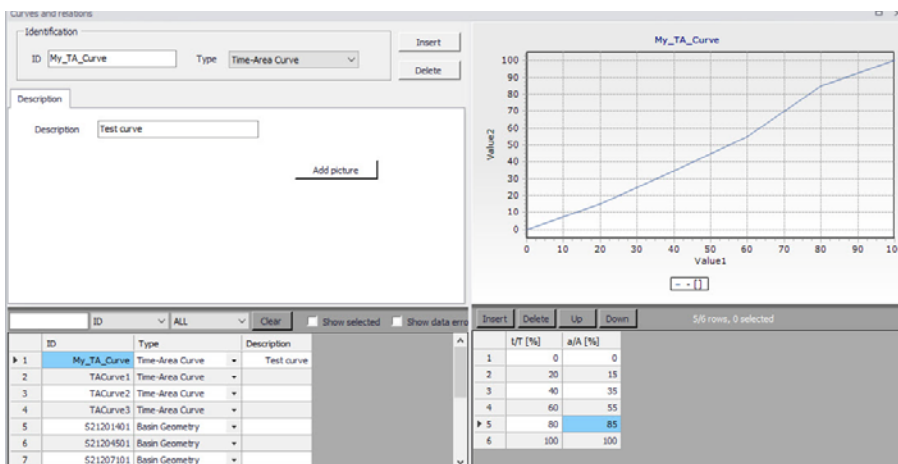

Figure 4.10 The Curves and Relations Editor with a user-defined Time-Area curve



## 4.2.2 Kinematic Wave (B)

The Kinematic Wave (Model B) is a surface runoff model with moderate data requirements. The runoff computation is based on a comprehensive treatment of hydrological losses (including infiltration) and the runoff routing by the Kinematic Wave (Manning) formula. Technical details can be found in the MIKE 1D Reference Manual.

### Model Data

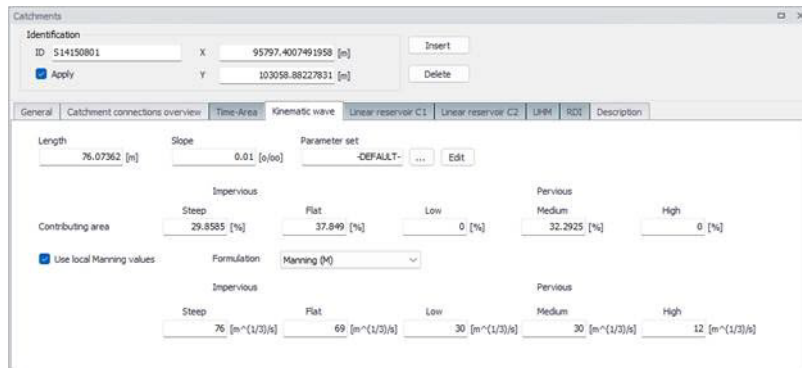

Figure 4.11 The Kinematic Wave Model Tab

A full overview of the editor fields and corresponding attributes is provided in the Table 4.6.

Table 4.6 Overview of the Kinematic Wave model attributes (Table ms\_Catchment)

Edit field	Description	Used or required by simulations	Field name in datastructure
Length	Characteristic length of the catchment	Yes	ModelBLength
Slope	Representative slope of the catchment	Yes	ModelBSlope
Parameter Set	Reference to a set of model parameters to be used for the current catchment	Yes	ModelBParBID



Table 4.6 Overview of the Kinematic Wave model attributes (Table ms\_Catchment)

Edit field	Description	Used or required by simulations	Field name in datastructure
Contributing Area (five fields)	Fraction of the actual model area for each surface category	Yes	ModelBAISteep, ModelBAIFlat, ModelBAPSmall, ModelBAPMedium, ModelBAPLarge
Use Local Manning values	Allows for local use of individual Manning coefficients	Optional	ModelBLocalNo
Formulation	Selects whether the local Manning values are expressed as Manning (M) or Manning (n)	Yes, If Use local Manning values is chosen	FricTypeNo
Manning Number (five fields)	Local value of the Manning number for various types of catchment surfaces	Optional	ModelBMISteep, ModelBMIFlat, ModelBMPSmall, ModelBMPMedium, ModelBMPLarge

## Parameters Kinematic Wave

The Kinematic Wave model uses a relatively large number of parameters. For practical reasons, these parameters have been grouped in parameter sets, which, in turn, can be associated with certain catchments. The entire model setup can thus be established with a very small amount of information, while still allowing for full spatial variation of model parameters for individual catchments through the application of local values.

New parameter sets can be inserted and values of individual parameters can be edited in the Parameters Kinematic Wave Editor. This can be activated at Catchments|Parameters Kinematic Wave.

MIKE+ comes with a Default parameter set (-DEFAULT-). The User can insert any number of parameter sets and edit them as needed.



Figure 4.12 The Kinematic Wave Parameter Sets Editor (Catchments|Parameters Kinematic Wave)

A full overview of the editor fields and corresponding database attributes is provided in the Table 4.7.

Table 4.7 Overview of the Kinematic Wave Parameter Set Attributes (Table msm\_HParB)

Edit field	Description	Used or required by simulations	Field name in datastructure
Parameter set ID	Parameter set identifier	Yes	MUID
Wetting (five fields)	Wetting initial loss on various types of surfaces	Yes	WetSteep, WetFlat, WetSmall, WetMedium, WetLarge
Storage (four fields)	Storage initial loss on various types of surfaces	Yes	StorageFlat, StorageSmall, StorageMedium, StorageLarge



Table 4.7 Overview of the Kinematic Wave Parameter Set Attributes (Table msm\_HParB)

Edit field	Description	Used or required by simulations	Field name in datastructure
Maximum (three fields)	Horton's maximum infiltration capacity on various types of surfaces	Yes	InfMaxSmall, InfMaxMedium, InfMaxLarge
Minimum (three fields)	Horton's minimum infiltration capacity on various types of surfaces	Yes	InfMinSmall, InfMinMedium, InfMinLarge
Wet Condition (three fields)	Horton's exponent for wet conditions on various types of surfaces	Yes	InfExpWetSmall, InfExpWetMedium, InfExpWetLarge
Dry Condition (three fields)	Horton's exponent for dry conditions on various types of surfaces	Yes	InfExpDrySmall, InfExpDryMedium, InfExpDryLarge
Formulation	Selects whether the Manning values are expressed as Manning (M) or Manning (n)	Yes	FricTypeNo
Manning (five fields)	Manning number for various types of catchment surfaces	Yes	ManningSteep, ManningFlat, ManningSmall, ManningMedium, ManningLarge

### 4.2.3 Linear Reservoir (C1 and C2)

The Linear Reservoir model (Model C) is a surface runoff model with minimum data requirements. The runoff computation is based on a comprehensive treatment of hydrological losses (including infiltration) and runoff routing by the linear reservoir principle. Technical details can be found in the MIKE 1D Reference Manual.

MIKE+ includes this model in two versions: C1 and C2. These are variants of the same model, and are used as national standards in the Netherlands and France, respectively.





## Linear Reservoir C1 Model Data

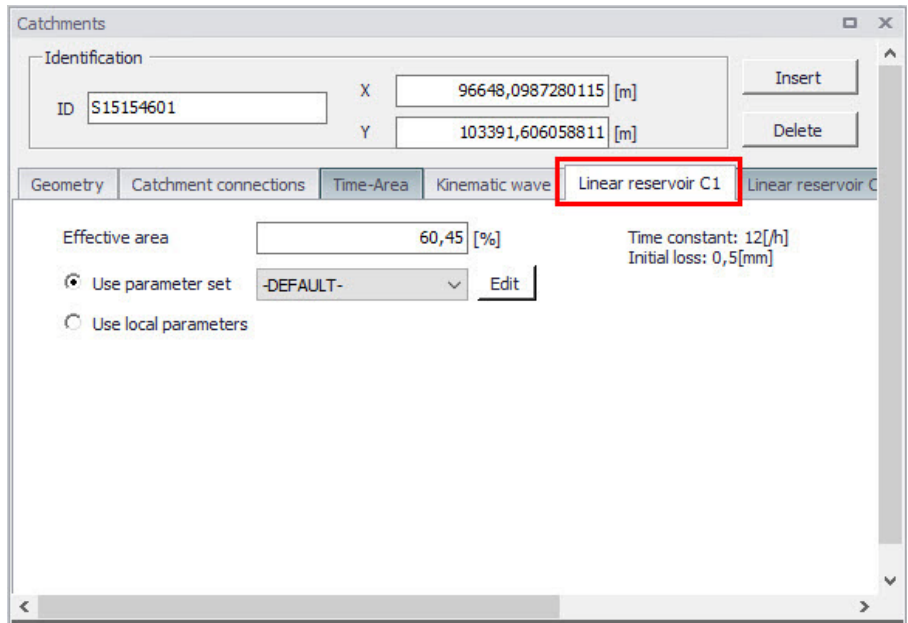

Figure 4.13 The Linear Reservoir C1 Model Tab

A full overview of the editor fields and corresponding attributes for the Linear Reservoir C1 model is provided in the Table 4.8.

Table 4.8 Overview of the Linear Reservoir C1 attributes (Table msm\_Catchment)

Edit field	Description	Used or required by simulations	Field name in datastructure
Effective Area	Contributing area	Yes	ModelC1EffectiveArea
Use Parameter Set	Reference to a set of model parameters to be used for the current catchment	Yes	ModelC1ParCID
Use Local Parameters	Allows for local use of individual parameters	Optional	ModelC1LocalNo

Table 4.8 Overview of the Linear Reservoir C1 attributes (Table msm\_Catchment)

Edit field	Description	Used or required by simulations	Field name in datastructure
Time Constant	Local value of the time constant	Optional	ModelC1TimeConst
Init. Loss	Local value of the initial loss	Optional	ModelC1Iloss

## Linear Reservoir C2 Model Data

Figure 4.14 The Linear Reservoir C2 Model Tab

A full overview of the editor fields and corresponding Linear Reservoir C2 model attributes is provided in the Table 4.9.

Table 4.9 Overview of the Linear Reservoir C2 attributes (Table msm\_Catchment)

Edit field	Description	Used or required by simulations	Field name in datastructure
Length	Characteristic length of the catchment	Yes	ModelCLength
Slope	Representative slope of the catchment	Yes	ModelCSlope



Table 4.9 Overview of the Linear Reservoir C2 attributes (Table msm\_Catchment)

Edit field	Description	Used or required by simulations	Field name in datastructure
Imperviousness	Impervious area as a percentage of the actual model area. For values $\geq 20\%$ , the catchment is an urban catchment. For values $< 20\%$ , the catchment is a rural one.	Yes	ModelC2ImperviousArea
Use Parameter Set	Reference to a set of model parameters to be used for the current catchment	Yes	ModelC2ParCID
Use Local Parameters	Allows for local use of individual parameters	Optional	ModelC2LocalNo
Reduction Factor	Local value of the hydrological reduction factor	Optional	ModelC2RedFactor
Init. Loss	Local value of the initial loss	Optional	ModelC2Iloss
Lag Time	Local value of the lag time	Optional	ModelC2LagTime

## Parameters Linear Reservoir

The Linear Reservoir model uses a number of parameters. For practical reasons, these parameters have been grouped in parameter sets, which, in turn, can be associated with certain catchments. This means the entire model setup can be established with a very small amount of information, while still allowing for full spatial variation of model parameters for individual catchments through the application of local values.

New parameter sets can be inserted and values of individual parameters can be edited in the Parameters Linear Reservoir Editor. This can be activated via Catchments|Parameters Linear Reservoir.

MIKE+ comes with a Default parameter set (-DEFAULT-). The User can insert any number of parameter sets and edit them as needed.



Parameters linear reservoir

Identification

Parameter set ID

Insert

Delete

Parameters

C1  C2

Initial loss  [mm] Time constant  [h]

Reduction factor  [0] Lag time  [min]

Infiltration

Horton's infiltration capacity

Maximum  [mm/h] Time constants

Minimum  [mm/h] Wet condition  [h]

Dry condition  [h]

ID ALL Clear Show selected Show data errors 1/1 rows, 0 selected

ID	Max Cap [mm/h]	R. factor [0]	I loss [mm]	Lag time [min]	Infiltr	Min Cap [mm/h]	Wet Con
1	-DEFAULT-	2	0,9	0,5	5	<input checked="" type="checkbox"/>	0,5

Figure 4.15 The Linear Reservoir C1 Parameter Sets Editor (Catchments|Parameters Linear Reservoir) - Dutch version

Parameters linear reservoir

Identification

Parameter set ID

Insert

Delete

Parameters

C1  C2

Initial loss  [mm] Time constant  [h]

Reduction factor  [0] Lag time  [min]

Infiltration

Horton's infiltration capacity

Maximum  [mm/h] Time constants

Minimum  [mm/h] Wet condition  [h]

Dry condition  [h]

ID ALL Clear Show selected Show data errors 1/1 rows, 0 selected

ID	Max Cap [mm/h]	R. factor [0]	I loss [mm]	Lag time [min]	Infiltr	Min Cap [mm/h]	Wet Con
1	-DEFAULT-	2	0,9	0,5	5	<input checked="" type="checkbox"/>	0,5

Figure 4.16 The Linear Reservoir C2 Parameter Sets Editor (Catchments|Parameters Linear Reservoir) - French version

A full overview of the editor fields and corresponding database attributes is provided in the Table 4.10.



Table 4.10 Overview of the Linear Reservoir Parameter Set attributes (Table msm\_HParC)

Edit field	Description	Used or required by simulations	Field name in datastructure
Parameter Set ID	Parameter set identifier	Yes	MUID
C1/C2	Toggle for editor setting for model C1 and C2, respectively	Yes	-
Initial Loss	Local value of the initial loss	Yes	lloss
Time Constant	Local value of the time constant	Optional, model C1 only	CTime
Reduction Factor	Local value of the hydrological reduction factor	Optional, model C2 only	RFactor
Lag Time	Local value of the lag time	Optional, model C2 only	LagTime
Infiltration	Toggle for switching ON and OFF calculation of infiltration	Optional	InfiltrNo
Maximum Horton's Infiltration Capacity	Maximum infiltration capacity	Optional, if infiltration included	MaxCap
Minimum Horton's infiltration capacity	Minimum infiltration capacity	Optional, if infiltration included	MinCap
Wet Condition Time Constant	Infiltration time constant for wet conditions	Optional, if infiltration included	WetCond
Dry Condition Time Constant	Infiltration time constant for dry conditions	Optional, if infiltration included	DryCond

#### 4.2.4 Unit Hydrograph Method (UHM)

The Unit Hydrograph Method (UHM) is a simple linear surface runoff model used to derive hydrographs for any amount of excess precipitation. The runoff computation includes a comprehensive treatment of hydrological losses (i.e. calculation of excess precipitation) and runoff routing through creation of a composite hydrograph. Technical details can be found in the MIKE 1D Reference Manual.



Figure 4.17 The Unit Hydrograph Model Tab

An overview of the editor fields and corresponding UHM Model attributes is provided in the Table 4.11.

Table 4.11 Overview of the UHM Model attributes (Table msm\_Catchment)

Edit field	Description	Used or required by simulations	Field name in datastructure
Contributin area fraction	Relative size of contributing area	Yes	UHMAreaFactor
Cp	Hydrograph peak factor	Optional, SUH Standard method only	UHMCp
Hydrograph	Method for hydrograph computation	Yes	UHMMethodNo
Slope	Representative catchment slope	Optional, SUH Alameda method only	UHMSuhSlope
Loss Model	Method for computing hydrological losses	Yes	UHMLossModelNo
Initial Loss	Initial loss	Optional, Constant Loss method only	UHMInitLoss
Constant Loss	Constant loss	Optional, Constant Loss method only	UHMCnstLoss
Runoff Coefficient	Runoff coefficient	Optional, Proportional Loss method only	UHMRunoffCoeff



Table 4.11 Overview of the UHM Model attributes (Table msm\_Catchment)

Edit field	Description	Used or required by simulations	Field name in datastructure
Curve Number	Standard hydrograph curve number	Optional, SCS and SCS Generalized loss methods only	UHMCurveNum
Initial AMC	Antecedent moisture condition	Optional, SCS loss method only	UHMAC
Initial Abstr. Depth	Initial abstraction depth	Optional, SCS Generalized loss method only	UHMinInitAbstract-Depth
Lag Time Method	Method for lag time computation	Yes	UHMLagTimeMethodNo
Lag Time	User-specified lag time	Optional, User specified lag time method only	UHMLagTime
Hydraulic Length	Hydraulic length of the catchment	Optional, SCS Formula lag time method only	UHMHydraulicLength
LT Curve No.	CSC Curve number used for computing lag time	Optional, SCS Formula lag time method only	UHMLagCurveNum
LT Slope	Average catchment slope	Optional, SCS Formula lag time method only	UHMSlope
L	Length of the main stream from outlet to the divide	Optional, SUH Standard and Alameda lag time methods only	UHMSuhL
Ct	Watershed (catchment) coefficient	Optional, SUH Standard lag time method only	UHMSuhCt
Lc	Length of the main stream from the outlet to the point closest to the catchment centroid	Optional, SUH Standard and Alameda lag time methods only	UHMSuhLc
Stream Slope	Average Overland Slope	Optional, SUH Alameda lag time method only	UHMStreamSlope
Basin Factor	Basin factor	Optional, SUH Alameda lag time method only	UHMBasFactor



## 4.2.5 RDI

Continuous runoff from MIKE+ catchments can be modelled using an RDI computation, a continuous hydrological model Rainfall Dependent Infiltration (RDI). RDI provides detailed, continuous modelling of the complete land phase of the hydrologic cycle, providing support for urban, rural, and mixed catchments analyses. Precipitation is routed through four different types of storage: snow, surface, unsaturated zone (root-zone) and groundwater. This enables continuous modelling of the runoff processes, which is particularly useful when long-term hydraulic and pollution load effects are analyzed.

Instead of only performing hydrological load analysis of the sewer system for short periods of high intensity rainstorms, a continuous, long-term analysis is applied to look at periods of both wet and dry weather, as well as inflows and infiltration to the sewer network. This provides a more accurate picture of actual loads on treatment plants and combined sewer overflows.

When studying the real flow conditions in sewer systems, flow peaks during rain events are often found to exceed the values that can be attributed to the contribution from participating impervious areas. This is a consequence of the phenomenon, usually named Rainfall Induced Infiltration. This differs from the Rainfall Induced Inflow by the fact that it does not only depend on the actual precipitation, but is heavily affected by the actual hydrological situation, i.e. the memory from earlier hydrological events. For a certain rainfall event, the increase in flow will therefore differ, depending on hydrological events during the previous period. The Rainfall Induced Infiltration is also distinguished by a slow flow response, which takes place during several days after the rainfall event.

From a hydrological point of view, parts of the infiltration behave in the same way as the inflow. Therefore, classification of total hydrological loads to infiltration and inflow is not suitable for modelling approach. Rather, to describe appropriately the constitutive components of flow hydrographs distinguished by their hydrological behaviour, the following concept is used instead:

- FRC - Fast Response Component: comprises the rain induced inflow and fast infiltration component;
- SRC - Slow Response Component: comprises slow infiltration component.

Distinctive for the FRC component is that it is not influenced by the previous hydrological situation, i.e. high or low soil moisture content. It occurs as a direct consequence of a rainfall. The FRC component consists of the inflow to the sewer system and the fast flow component of the infiltration, not dependent on previous hydrological conditions.

On the other hand, characteristic of the SRC component is that it is highly dependent on previous hydrological conditions and usually responds slowly





to a rainfall. The SRC component consists of the rest of the precipitation-induced infiltration and dry weather infiltration/inflow.

When combined with any of the surface runoff models, RDI provides a platform for accurate and reliable computation of runoff free from the limitations inherent to standard urban runoff modelling.

Figure 4.18 shows an example illustrating the influence of previous hydrological conditions for the two components and their response to a rainfall.

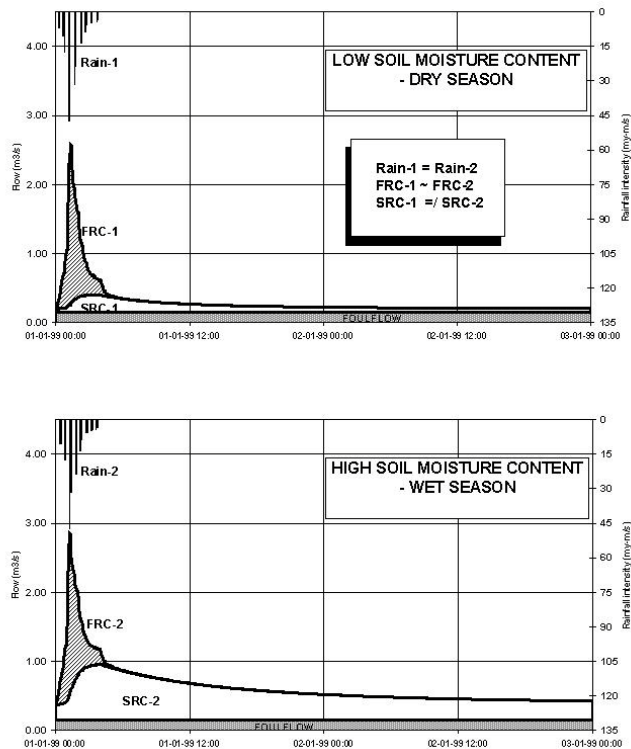

Figure 4.18 Different catchment response under the same rainfall due to different soil moisture conditions at the beginning of the rainfall

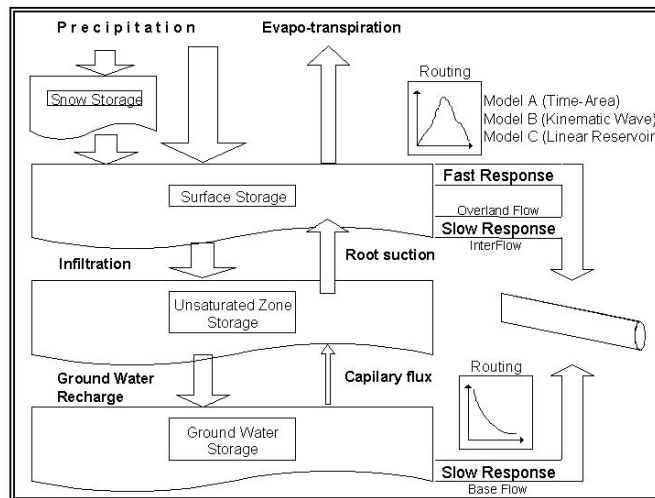

Figure 4.19 Schematics of the RDI Model

## Model Data

The model data for additional catchment flow and RDI are in the database table `msm_Catchment`.

General	Catchment connections overview	Time-Area	Kinematic wave	Linear reservoir C1	Linear reservoir C2	UHM	RDI	Description
Contributing area percentage <input type="text" value="100"/> [%]								
Parameter set <input type="text" value="Parm_S14"/> <input type="button" value="..."/> <input type="button" value="Edit"/>								
<input type="checkbox"/> Include autocalibration <input type="button" value="Edit measurement"/>								

Figure 4.20 The RDI tab in the Catchments editor

The contributing area percentage is the fraction of the catchment area to which the RDI model is applied. The parameter set is selected from the list of sets, defined in the 'Parameters RDI' editor.

When 'Include autocalibration' is selected, the simulation will initially run iterations to calibrate the RDI parameters in the selected parameter set against a discharge measurement time series, in `.dfs0` file format. This discharge measurement time series must be specified in a measurement station connected to the same catchment (in 'Calibrations | Measurement stations').

A full overview of the editor fields and corresponding database attributes is provided in the Table 4.12.



Table 4.12 Overview of the RDI attributes (Table msm\_Catchment)

Edit field	Description	Used or required by simulations	Field name in datastructure
Contributing area percentage	Fraction of catchment area to which the RDI model is applied	Yes, if RDI activated	RdiiArea
Parameter Set	Reference to a set of RDI model parameters to be used for the current catchment	Yes, if RDI activated	ParRDiiID
Include autocalibration	Enables automatic calibration of the RDI parameters against measurement time series	Optional	IncludeAutoCalNo

## Parameters RDI

The RDI Model uses a large number of parameters. For practical reasons, these parameters have been grouped in parameter sets, which can be associated with certain catchments. This means the entire model setup can be established with a very small amount of information.

New parameter sets can be inserted and values of individual parameters can be edited in the Parameters RDI Editor. This can be activated via Catchments|Parameters RDI.

MIKE+ comes with a Default RDI parameter set (-DEFAULT-). The User can insert any number of parameter sets and edit them as needed.

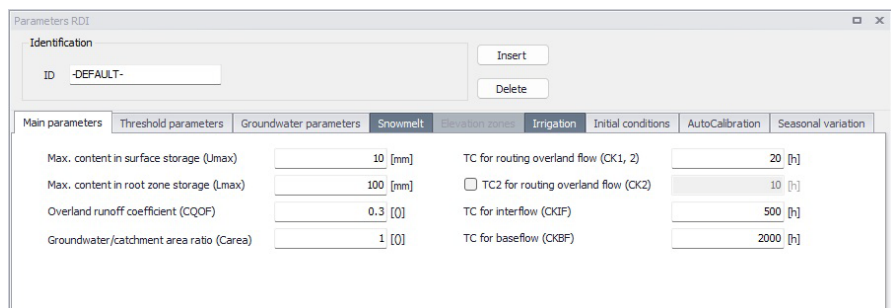

Figure 4.21 The Main Parameters tab



The RDI parameters are grouped into Tabs in the editor by:

- Main parameters
- Threshold parameters
- Groundwater parameters
- Snow melt
- Elevation zones
- Irrigation
- Initial conditions
- AutoCalibration
- Seasonal variation

A full overview of the editor fields and corresponding database attributes is provided in the tables below.

Table 4.13 Overview of Parameters RDI Main Parameters Tab attributes (Table 'msm\_HParRDII')

<b>Edit field</b>	<b>Description</b>	<b>Used or required by simulations</b>	<b>Field name in datastructure</b>
ID	Parameter set identifier	Yes	MUID
Max. content in surface storage (Umax)	Capacity of surface storage. It represents the cumulative total water content of the interception storage (on vegetation), surface depression storage and storage in the uppermost layers (a few cm) of the soil. Typical values are between 10-20 mm.	Yes	Umax



Table 4.13 Overview of Parameters RDI Main Parameters Tab attributes (Table 'msm\_HParRDII')

Edit field	Description	Used or required by simulations	Field name in datastructure
Max. content in root zone storage (Lmax)	Capacity of root zone (lower) storage. It represents the maximum soil moisture content in the root zone, which is available for transpiration by vegetation. Typical values are between 50-300 mm.	Yes	Lmax
Overland runoff coefficient (CQOF)	Fraction of runoff going to overland flow. It determines the division of excess rainfall between overland flow and infiltration.	Yes	Cqof
Groundwater(catchment area ratio (Carea)	This parameter describes the ratio of the groundwater catchment area to the topographical surface water catchment area. Local geological condition may cause part of the infiltrating water to drain to another catchment. This loss of water is described by a Carea less than one. Usual value: 1.0.	Yes	GwCarea



Table 4.13 Overview of Parameters RDI Main Parameters Tab attributes (Table 'msm\_HParRDI')

Edit field	Description	Used or required by simulations	Field name in datastructure
TC for routing overland flow (CK1,2)	Time constant for overland runoff component. It determines the shape of hydrograph peaks. The routing takes place through two linear reservoirs (serially connected) with different time constants, expressed in [hours]. High, sharp peaks are simulated with small time constants, whereas low peaks, at a later time, are simulated with large values of these parameters. Values in the range of 3-48 hours are common.	Yes	Ck
TC2 for routing overland flow (CK2)	Enables specification of a second time constant for the second linear reservoir.	Optional	Ck2TypeNo
CK2 value	The time constant for the second linear reservoir, when 'TC2 overland flow (CK2)' is selected	Yes, if 'TC2 overland flow (CK2)' is selected	Ck2



Table 4.13 Overview of Parameters RDI Main Parameters Tab attributes (Table 'msm\_HParRDII')

Edit field	Description	Used or required by simulations	Field name in datastructure
TC for interflow (CKIF)	Time constant for interflow runoff component. It determines the amount of interflow, which decreases with larger time constants. Values in the range of 500-1000 hours are common.	Yes	Ckif
TC for baseflow (CKBF)	Time constant for baseflow runoff component. It can be determined from the hydrograph recession in dry periods. In rare cases, the shape of the measured recession changes to a slower recession after some time. To simulate this, a second groundwater reservoir may be included, in the 'Groundwater parameters' tab.	Yes	Ckbf

Main parameters	Threshold parameters	Groundwater parameters	Snowmelt	Evaporation	Irrigation	Initial conditions	AutoCalibration	Seasonal variation
		Root zone fraction for overland flow (TOF)	<input type="text" value="0"/>	[0]				
		Root zone fraction for interflow (TIF)	<input type="text" value="0"/>	[0]				
		Root zone fraction for groundwater recharge (TG)	<input type="text" value="0"/>	[0]				

Figure 4.22 The Threshold Parameters Tab



Table 4.14 Overview of Parameters RDI Threshold Parameters Tab attributes (Table 'msm\_HParRDII')

Edit field	Description	Used or required by simulations	Field name in datastructure
Root zone fraction for overland flow (TOF)	Fraction of root zone capacity above which overland flow starts. The main impact of TOF is seen at the beginning of a wet season, where an increase of the parameter value will delay the start of runoff as overland flow. Threshold value range between 0 and 70% of Lmax, and the maximum value allowed is 0.99.	Yes	Tof
Root zone fraction for interflow (TIF)	Fraction of root zone capacity above which interflow starts.	Yes	Tif
Root zone fraction for groundwater recharge (TG)	Fraction of root zone capacity above which groundwater recharge starts. The main impact of increasing TG is less recharge to the groundwater storage. Threshold values range between 0 and 70% of Lmax and the maximum value allowed is 0.99.	Yes	Tg





Parameters RDI

Identification

ID:  Insert  
Delete

---

Main parameters  
  Threshold parameters  
  Groundwater parameters  
  Snowmelt  
  Evaporation zones  
  Irrigation  
  Initial conditions  
  AutoCalibration  
  Seasonal variation

Specific yield of groundwater reservoir (Sy)	<input type="text" value="0.1"/> [0]	<input type="checkbox"/> Use lower baseflow	
Min. groundwater depth below surface (GWLmin)	<input type="text" value="0"/> [m]	Recharge to groundwater (CQLow)	<input type="text" value="0"/> [%]
Max. groundwater depth causing baseflow (GWLbft0)	<input type="text" value="10"/> [m]	TC for routing lower baseflow (CKLow)	<input type="text" value="10000"/> [h]
<input type="checkbox"/> Seasonal variation of groundwater depth causing baseflow		<input type="checkbox"/> Use abstraction	
Min. GW depth for seasonal variation (GWLBF_min)	<input type="text" value="0"/> [m]	Pumped depth defined as	<input type="text" value="Varying in time"/>
Groundwater depth for unit capillary flux (GWLf1)	<input type="text" value="0"/> [m]		

Figure 4.23 The Groundwater Parameters Tab



Table 4.15 Overview of Parameters RDI Groundwater Parameters Tab attributes (Table 'msm\_HParRDII')

Edit field	Description	Used or required by simulations	Field name in datastructure
Specific yield of groundwater reservoir (Sy)	Specific yield of the groundwater reservoir (porosity). This parameter should be kept at the default value except for the special cases in which the groundwater level is used for calibration. This may be required in riparian areas, for example, where the outflow of groundwater strongly influences the seasonal variation of the levels in the surrounding rivers. Simulation of groundwater level variation requires values of the specific yield Sy and of the groundwater outflow level GWLbf0, which may vary in time. The value of Sy depends on the soil type and may often be assessed from hydrogeological data, e.g. test pumping. Typically values of 0.01-0.10 for clay and 0.10-0.30 for sand are used.	Yes	GwSy
Min. groundwater depth below surface (GWLmin)	Top of the groundwater storage (depth from surface)	Yes	GWLmin



Table 4.15 Overview of Parameters RDI Groundwater Parameters Tab attributes (Table 'msm\_HParRDII')

Edit field	Description	Used or required by simulations	Field name in datastructure
Max. groundwater depth causing base-flow (GWLbf0)	Bottom of the groundwater storage (depth from surface)). This parameter should be kept at the default value except for the special cases in which the groundwater level is used for calibration, cf. Sy above.	Yes	GWLbf0
Seasonal variation of groundwater depth causing base-flow	In low-lying catchments the annual variation of the maximum groundwater depth may be of importance. This variation relative to the difference between the maximum and minimum groundwater depth can be entered if the option is ticked. The monthly values are given relative to the difference between GWLbf0 and GWLBF_min [0-1]. This is done in the 'Seasonal variation' tab, in the column 'Variation of groundwater maximum water depth'.	Optional	GWSeasonTypeNo
Min. GW depth for seasonal variation (GWLBF_min)	If the Seasonal variation of groundwater depth causing base-flow is selected, the minimum groundwater depth [m] has also to be entered for the calculations.	Optional	GWLBFMin



Table 4.15 Overview of Parameters RDI Groundwater Parameters Tab attributes (Table 'msm\_HParRDII')

Edit field	Description	Used or required by simulations	Field name in datastructure
Groundwater depth for unit capillary flux (GWLf1)	Groundwater depth causing an upward capillary flux of 1 mm/day when the upper soil layers are dry corresponding to wilting point. The effect of capillary flux is negligible for most applications. Keep the default value of 0.0 to disregard capillary flux.	Yes	Gwlfl1
Use lower baseflow	Activates the use of a second linear reservoir, which can have a larger time constant to better represent the groundwater recession.	Optional	LowerBFTypeNo
Recharge to groundwater (CQLow)	The recharge to the lower (second) groundwater reservoir is specified here as a percentage of the total recharge.	Yes, if 'Use lower baseflow' is selected	CQLow
TC for routing lower baseflow (CKLow)	A baseflow time constant, which is usually larger than the CKBF.	Yes, if 'Use lower baseflow' is selected	CKLow



Table 4.15 Overview of Parameters RDI Groundwater Parameters Tab attributes (Table 'msm\_HParRDII')

Edit field	Description	Used or required by simulations	Field name in datastructure
Use abstraction	If this option is selected, it is possible to specify the groundwater abstraction depth from the catchment.	Optional	AbstractionTypeNo
Pumped depth defined as	When abstraction is used, the pumped depth can be defined either as 'Varying in time' (in which case the time series is provided as a catchment boundary condition), or using 'Seasonal variation' (in which case monthly values of abstraction depth are defined in the 'Seasonal variation' tab).	Optional	AbstractionSource-TypeNo

The screenshot shows the 'Snowmelt' tab with the following settings:

- Include snowmelt
- Base temperature (T0): 0 [deg C]
- Degree-day coefficient type: Constant
- Degree-day coefficient (C<sub>snow</sub>): 2 [mm/deg C/d]
- Use solar radiation
- Radiation coefficient: 0 [0]
- Use rainfall heat transfer
- Rainfall degree-day coefficient (C<sub>rain</sub>): 0 [deg C/d]

Figure 4.24 The 'Snowmelt' Tab

The snow module simulates the accumulation and melting of snow in a RDI catchment. It is included in the model when the 'Include snowmelt' checkbox is ticked.

The snow melt module uses a temperature input time series, usually mean daily temperature. This has to be specified as a boundary condition for the catchments.



Table 4.16 Overview of the 'Snowmelt' tab attributes (Table 'msm\_HParRDII')

Edit field	Description	Used or required by simulations	Field name in data-structure
Include snowmelt	Switch for activation of the snow storage / snowmelt processes	Yes	SnowmeltNo
Base temperature (T0)	The precipitation is retained in the snow storage only if the temperature is below the base temperature, whereas it is bypassed to the surface storage (U) in situations with higher temperatures. The base temperature is usually at or near zero degree C.	Optional	T0
Degree-day coefficient type	The content of the snow storage melts at a rate defined by the degree-day coefficient multiplied by the temperature difference above the 'Base temperature'. This degree-day coefficient can either be constant during the simulation, or varying in time (in which case a time series of degree-day coefficient has to be provided as boundary condition to the catchment), or using seasonal variation (in which case the monthly values of the coefficient have to be specified in the 'Seasonal variation' tab).	Optional	SnowmeltCTypeNo



Table 4.16 Overview of the 'Snowmelt' tab attributes (Table 'msm\_HParRDII')

Edit field	Description	Used or required by simulations	Field name in data-structure
Degree-day coefficient (Csnow)	The constant value of the degree-day coefficient. Typical values for Csnow are 2-4 mm/day/C.	Optional	SnowmeltC
Use solar radiation	This option may be enabled when time series data for incoming radiation are available. The radiation time series must be specified as a boundary condition to the catchment. The total snow melt is calculated as a contribution from the traditional snow melt approach based on Csnow (representing the convective term) plus a term based on the radiation.	Optional	RadiationTypeNo
Radiation coefficient	The radiation coefficient value, when the effect of solar radiation is included.	Optional	RadiationCoef
Use rainfall heat transfer	This option may be enabled when the melting effect from the advective heat transferred to the snow pack by rainfall is significant.	Optional	RainfallCoefTypeNo
Rainfall degree-day coefficient (Crain)	This heat transfer from the rainfall is represented in the snow module as a linear function of the precipitation multiplied by the rainfall degree-day coefficient and the temperature deviation above the base temperature.	Optional	RainfallCoef



Main parameters | Threshold parameters | Groundwater parameters | Snowmelt | **Elevation zones** | Irrigation | Initial conditions | AutoCalibration | Seasonal variation

Delineate catchment into elevation zones for snow modelling

Vertical corrections

Correct temperature in dry condition      Correction      -0.6 [deg C/100m]     

Correct temperature in wet condition      Correction      -0.4 [deg C/100m]

Reference elevation for temperature station      1540 [m]

Correct precipitation rate      Correction      2 [%/100m]

Reference elevation for precipitation station      1320 [m]

Insert    Delete    Up    Down      3/4 rows, 0 selected

Elevation zones							
	Zone	Elevation [m]	Area [km <sup>2</sup> ]	Min storage for full coverage [mm]	Max storage in zone [mm]	Max water retained in snow [%]	Dry temperatu
1	1	855	40215	100	10000	0	
2	2	1115	24650	100	10000	0	
▶ 3	3	1490	12400	100	10000	0	
4	4	1920	6420	100	10000	0	

Figure 4.25 The 'Elevation zones' Tab

The 'Elevation zones' tab becomes available when snowmelt is included in the model. When the 'Delineate catchment into elevation zones for snow modelling' option is selected, the snowmelt distributed approach is applied. Following this approach, the catchment is divided into a certain number of elevation zones, each with specific snow melt parameters, temperature and precipitation inputs.

Global parameters used with elevation zones are described in the table below.





Table 4.17 Overview of the global attributes in the 'Elevation zones' tab (Table 'msm\_HParRDII')

Edit field	Description	Used or required by simulations	Field name in data-structure
Delineate catchment into elevation zones for snow modelling	Switch to enable or disable the distributed approach for snowmelt modelling	Yes	ElevZonesNo
Correct temperature in dry condition	When this option is ticked, the temperature correction will be recomputed in the table of zones when pressing the 'Calculate corrections' button. The correction value specifies the vertical gradient [C/100 m] for adjustment of temperature under dry conditions. The temperature in the actual elevation zone is calculated based on a linear transformation of the temperature from the reference station to the actual zone, the correction being defined as the dry temperature lapse rate multiplied by the difference in elevations between the reference station and the zone.	Optional	CorrectDryTempNo and Correct-DryTempCorrection



Table 4.17 Overview of the global attributes in the 'Elevation zones' tab (Table 'msm\_HParRDI')

Edit field	Description	Used or required by simulations	Field name in data-structure
Correct temperature in wet condition	When this option is ticked, the temperature correction will be recomputed in the table of zones when pressing the 'Calculate corrections' button. The correction value specifies the vertical gradient [C/100 m] for adjustment of temperature under wet conditions, defined as days with precipitation higher than 10 [mm]. The temperature in the actual elevation zone is calculated based on a linear transformation of the temperature from the reference station to the actual zone, the correction being defined as the wet temperature lapse rate multiplied by the difference in elevations between the reference station and the actual zone.	Optional	CorrectWetTempNo and CorrectWetTempCorrection
Reference elevation for temperature station	This parameter defines the elevation of the reference temperature station. This station is used as a reference for calculating the temperature correction within each elevation zone.	Optional	TempStationElev



Table 4.17 Overview of the global attributes in the 'Elevation zones' tab (Table 'msm\_HParRDII')

Edit field	Description	Used or required by simulations	Field name in data-structure
Correct precipitation rate	When this option is ticked, the precipitation correction will be recomputed in the table of zones when pressing the 'Calculate corrections' button. The correction value specifies the vertical gradient for adjustment of precipitation and is expressed in [percent/100 m]. The precipitation in the actual elevation zone is calculated based on a linear transformation of the precipitation from the reference station to the actual zone, the correction being defined as correction of precipitation rate [percent/100 m] multiplied by the difference in elevation between the reference station and the actual zone.	Optional	CorrectPrecNo and CorrectPrecCorrection
Reference elevation for precipitation station	This parameter defines the elevation of the reference precipitation station. This station is used as a reference for calculating the precipitation correction within each elevation zone.	Optional	PrecStationElev

Elevation zones are defined in the secondary table at the bottom of the tab. The number of zones is defined by the number of records in this table. Parameters used for each elevation zone are described in the table below.



Table 4.18 Overview of the zones' attributes in the 'Elevation zones' tab (Table 'msm\_HParRDII')

<b>Edit field</b>	<b>Description</b>	<b>Used or required by simulations</b>	<b>Field name in data-structure</b>
Elevation	The elevation of each zone is specified in the table as the average elevation of the zone. The elevation must increase from zone (i) to zone (i+1).	Yes	Elevation
Area	The area of the zone. The total area of the elevation zones must equal the area of the catchment.	Yes	Area
Min storage for full coverage	This parameter defines the required amount of snow to ensure that the zone area is fully covered with snow. When the water equivalent of the snow pack falls under this value, the area coverage (and the snow melt) will be reduced linearly with the snow storage in the zone.	Yes	MinStorage
Max storage in zone	This value defines the upper limit for snow storage in a zone. Snow above this value will be automatically redistributed to the neighbouring lower zone.	Yes	MaxStorage



Table 4.18 Overview of the zones' attributes in the 'Elevation zones' tab (Table 'msm\_HParRDII')

Edit field	Description	Used or required by simulations	Field name in data-structure
Max water retained in snow	It defines the maximum water content in the snow pack of the zone. Generated snow melt is retained in the snow storage as liquid water until the total amount of liquid water exceeds this water retention capacity. When the air temperature is below the base temperature $T_0$ , the liquid water of the snow re-freezes with rate $C_{snow}$ .	Yes	MaxWaterRetain
Dry temperature correction	The temperature correction for dry conditions to estimate actual temperature for the specific zone.	Yes	DryTempCorrection
Wet temperature correction	The temperature correction for wet conditions to estimate actual temperature for the specific zone.	Yes	WetTempCorrection
Precipitation correction	The relative correction for precipitation, expressed in percent, to estimate the precipitation for the specific zone.	Yes	PrecipTempCorrection



Parameter	Value	Unit
Infiltration rate at field capacity (K0inf)	1	[mm/h]
Local groundwater (PClgw)	35	[%]
Local river (PClr)	65	[%]
External river (PCexr)	0	[%]
Chainage	0	[m]

Figure 4.26 The 'Irrigation' Tab

An irrigation module is included in the rainfall-runoff model when the 'Include irrigation' box is ticked. The irrigation module is used for adjusting the water balance in the RDI model. The purpose of the irrigation module is that of simulating the runoff and groundwater recharge/baseflow from the irrigated areas, so that RDI can be calibrated for the non-irrigated part of the catchment.

Minor irrigation schemes within a catchment will normally have negligible influence on the catchment hydrology, unless transfer of water over catchment boundaries is involved. Large schemes, however, may significantly affect the runoff and the groundwater recharge through local increases in evapotranspiration and infiltration as well as through operational and field losses.

The irrigation module of RDI may be applied to describe the effect of irrigation on the following aspects:

- The overall water balance of the catchment. This will be affected mainly by the increased evapotranspiration and by possible external water sources for irrigation.
- Local infiltration and groundwater recharge in irrigated areas.
- The distribution of catchment runoff amongst different runoff components (overland flow, interflow, baseflow). This may be influenced by the increased infiltration in irrigated areas as well as by local abstraction of irrigation water from groundwater or streams.



Table 4.19 Overview of the 'Irrigation' tab attributes (Table 'msm\_HParRDII')

<b>Edit field</b>	<b>Description</b>	<b>Used or required by simulations</b>	<b>Field name in datastructure</b>
Include irrigation	A switch to enable or disable the irrigation module.	Yes	IncludelIrrigationNo
Infiltration rate at field capacity (K0inf)	This parameter defines the rate of infiltration at field capacity	Optional	K0inf
Local groundwater (PClgw)	Percentage of water for irrigation supplied by groundwater sources.	Optional	PClgw
Local river (PClr)	Percentage of water used for irrigation supplied by a local river.	Optional	PClr
External river (PCexr)	Percentage of water for irrigation supplied by a river external from the catchment.	Optional	PCexr
River ID	When part of the irrigation source comes from an external river (PCexr > 0), the River ID field is used to specify the location on the river network where the water is taken from.	Optional	RiverID



Table 4.19 Overview of the 'Irrigation' tab attributes (Table 'msm\_HParRDII')

Edit field	Description	Used or required by simulations	Field name in datastructure
Chainage	When part of the irrigation source comes from an external river, the Chainage field is used to specify the location on the river where the water is taken from.	Optional	Chainage
Include seasonal variation of crop coefficients and operational losses	If this checkbox is ticked, 'Irrigation crop coefficient' and 'Irrigation operational and conveyance losses' can be specified as monthly values in the 'Seasonal variation' tab. The 'Irrigation crop coefficient', also defined as Kc, allows to quantify the amount of water required and transpired by the crop. Different crops have different crop coefficient. Kc is multiplied by the reference ET of a standard crop (grass) to calculate the water demand of the crop of interest. 'Irrigation operational and conveyance losses' represent the system losses of irrigation water for the different components / processes (Groundwater, Overland flow, Evaporation).	Optional	IncludeSeasonal-VarNo





Main parameters	Threshold parameters	Groundwater parameters	Snowmelt	Evaporation	Irrigation	Initial conditions	AutoCalibration	Seasonal variation
Surface storage (U)		<input type="text" value="0"/> [mm]				Snow storage <input type="text" value="0"/> [mm]		
Root zone storage (L)		<input type="text" value="10"/> [mm]						
Overland flow (QOF)		<input type="text" value="1.5"/> [mm/h]						
Interflow (QIF)		<input type="text" value="0.5"/> [mm/h]						
Groundwater depth (GWL)		<input type="text" value="10"/> [m]						
Baseflow (BF)		<input type="text" value="4.35"/> [m <sup>3</sup> /s]						
Lower baseflow (BF-low)		<input type="text" value="1.2"/> [m <sup>3</sup> /s]						

Figure 4.27 The 'Initial Conditions' Tab

Table 4.20 Overview of Parameters RDI Initial Conditions Tab attributes (Table 'msm\_HParRDII')

Edit field	Description	Used or required by simulations	Field name in datastructure
Surface Storage (U)	Water depth in the surface storage at the simulation start	Yes	InitU
Root zone storage (L)	Moisture contents in the root zone at the simulation start	Yes	InitL
Overland flow (QOF)	Overland flow intensity at the simulation start	Yes	InitOf
Interflow (QIF)	Interflow intensity at the simulation start	Yes	InitIf
Groundwater depth (GWL)	Groundwater depth at the simulation start	Yes	InitGwl
Baseflow (BF)	The baseflow at the beginning of the simulation, which is normally estimated from the hydrograph.	Yes	InitBF
Lower baseflow (BF-low)	The lower baseflow at the beginning of the simulation, which is normally estimated from the hydrograph.	Yes	InitBFLow



Table 4.20 Overview of Parameters RDI Initial Conditions Tab attributes (Table 'msm\_HParRDI')

Edit field	Description	Used or required by simulations	Field name in datastructure
Snow storage	If elevation zones are not used for snow melt modelling, a unique snow storage value describes the initial amount of snow over the entire catchment. If elevation zones are used, a snow storage value is specified in the table for each zone.	Optional	SnowStorage
Water in snow	If elevation zones are used, a value representing the water content in the snow pack is specified in the table for each zone.	Optional	WaterInSnow

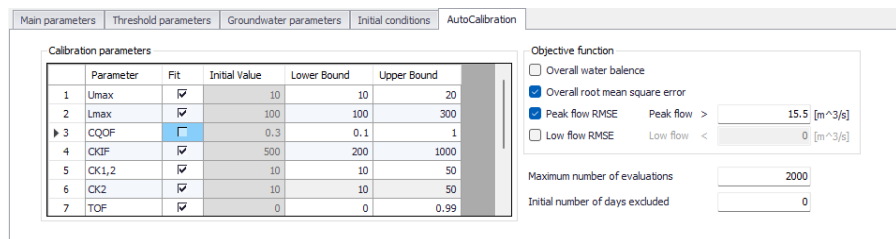

Figure 4.28 The AutoCalibration Tab

It is possible to use an automatic optimisation procedure to calibrate the 12 most important parameters in the RDI model. The calibration routine used in RDI is based on a multi-objective optimisation strategy, the SCE algorithm. The procedure implemented in RDI allows to simultaneously optimise four different calibration objectives or a combination of them. This automatic calibration is activated or deactivated from the 'RDI' tab in the Catchments editor.



In automatic calibration, the calibration objectives have to be formulated as numerical goodness-of-fit measures that are optimised. Four calibration objectives are defined as numerical performance measures in the autocalibration routine. These are selected and used by ticking the available check boxes:

- Overall water balance: this defines the agreement between the average simulated and observed catchment runoff overall volume error.
- Overall root mean squared error: this measure defines the overall agreement of the shape of the simulated hydrograph with the observed one.
- Peak flow RMSE: this optimisation measure defines the agreement of simulated and observed peak flows events. If this measure is selected, the minimum river discharge value above which the flow is defined as peak flow has to be specified in the Peak flow field.
- Low flow RMSE: this optimisation measure defines the agreement of simulated and observed low flows events. If this measure is selected, the maximum river discharge value below which the flow is defined as low flow has to be specified in the Low flow field.

Table 4.21 Overview of Parameters RDI, AutoCalibration tab, attributes (Table 'msm\_HParRDII')

Edit field	Description	Used or required by simulations	Field name in datastructure
Fit	If the 'Fit' check-box is ticked, the parameter is included in the autocalibration	Yes	FitNo
Initial value	It is the initial value for the parameter. It always corresponds to the value specified in the corresponding tab.	Yes	<i>Read-only</i>
Lower bound	Minimum value that the parameter can get	Yes	LowerBound
Upper bound	Maximum value that the parameter can get	Yes	UpperBound



Table 4.21 Overview of Parameters RDI, AutoCalibration tab, attributes (Table 'msm\_HParRDI')

Edit field	Description	Used or required by simulations	Field name in datastructure
Objective function	Selection of objective function for the calibration target.	Yes	ObjFuncWaterBalanceNo ObjFuncRmsErrorNo ObjFuncPeakflowNo ObjFuncLowflowNo
Maximum number of evaluations	The automatic calibration will stop either when the optimisation algorithm ceases to give an improvement in the calibration objective or when the maximum number of model evaluations is reached. Yes	Yes	ObjFuncMaxEvaluation
Initial number of days excluded	A warm up period that will be disregarded when calculating the objecting function.		ObjFuncInitDaysExcluded

Main parameters							Threshold parameters	Groundwater parameters	Snowmelt	Elevation zones	Irrigation	Initial conditions	AutoCalibration	Seasonal variation
1/12 rows, 0 selected														
	Month	Variation of groundwater maximum water depth ([])	Abstraction (mm/mth)	Degree day coefficient for snowmelt (mm/deg C/d)	Irrigation crop coefficient ([])	Irrigation operational and conveyance losses in %								
1	January	1	0	1	1	1								
2	February	1	0	1.5	1	1								
3	March	1	0	2	1	1								
4	April	1	0	3	1	1								
5	May	1	0	4	1	1								
6	June	1	0	4.5	1	1								
7	July	1	0	4.9	1	1								
8	August	1	0	4	1	1								
9	September	1	0	3	1	1								
10	October	1	0	2	1	1								
11	November	1	0	1.5	1	1								
12	December	1	0	1	1	1								

Figure 4.29 The 'Seasonal variation' Tab

In this tab, it is possible to enter the monthly values of some selected parameters. Whether a parameter uses a constant or a seasonal varying value is determined in the different tabs of the RDI parameters editor.

It is possible to specify a seasonal variation for the following parameters:



- Variation of groundwater maximum water depth: used for the seasonal variation of groundwater depth causing baseflow, when this option is active in the 'Groundwater parameters' tab.
- Abstraction: used for the seasonal variation of groundwater abstraction depth, when 'Use abstraction' is active in the 'Groundwater parameters' tab.
- Degree day coefficient for snow melt: used for the seasonal variation of the melting coefficient, when the 'Degree-day coefficient type' is defined with seasonal variation in the 'Snowmelt' tab.
- Irrigation crop coefficient: used for the seasonal variation of the parameter quantifying the amount of water required (and transpired) by the crop, when 'Include seasonal variation of crop coefficients and operational losses' is ticked in the 'Irrigation' tab.
- Irrigation operational and conveyance losses in percent of abstracted water: used for the seasonal variation of the system losses of irrigation water for the different components/processes (Groundwater, Overland flow and Evaporation), when 'Include seasonal variation of crop coefficients and operational losses' is ticked in the 'Irrigation' tab.

## 4.2.6 RDI - Guidelines for Application

### Choice of calculation time step

When calculating with RDI, time steps are given separately for the Surface Runoff Model and for the rain dependent infiltration part.

The RDI calculation can often be performed with a relatively long time step (several hours), while calculation with the Surface Runoff Model is typically performed with a time step in the order of several minutes.

The time step for Surface Runoff computations is primarily about the sufficient resolution of the runoff process in time.

Generally, the RDI simulation time step should be chosen in accordance with the resolution of precipitation data, e.g. a time step of 24 hours could be suitable if only daily precipitation data is available. However, in cases when precipitation data with high resolution of e.g. few minutes are available, the RDI time step should be chosen in accordance with the response of the discharge when raining. E.g. an RDI time step of 2-4 hours should be chosen if the time constant CKOF is given a value of 8 hours.

To minimize the calculation time as well as the size of the result files, the RDI calculations are performed according to the following principle:

The RDI simulation is carried out continuously for the whole period specified. On the contrary, the Surface Runoff simulation is carried out only when raining. Thus, the start time for the Surface Runoff calculation is set as the start



time for the rain hydrograph. The Surface Runoff calculation continues until all the surface runoff hydrographs are regressed.

## The RDI hotstart

There is a HOTSTART facility for RDI, i.e. the initial conditions for the various storages can be automatically taken from a former result file at a simulation start time.

The structure and contents of the result file used as a HOTSTART file requires that the time series in the boundary connection start at least for the maximum specified concentration time  $T_c$  earlier than the start time for the HOTSTART is specified. This is required for the correct reconstruction of the surface runoff component (FRC).

## RDI Validation

Some of the parameters in RDI (here meaning both for the rain dependent inflow and the infiltration part) are related to actual physical data. However, the final choice of parameter values must be based on a comparison with historical measured discharges since a number of the parameters have an empirical character.

The available period of the measured discharge data and its resolution in time are of major importance for the credibility of the obtained parameter values. Ideally, for good accuracy, a 3-5 years long time series of measured discharge data with daily values is required for the calibration of the RDI parameters. Several months long time series with higher resolution, i.e. minutes or hours, depending on the size of the area, are needed for the calibration of the surface runoff model. Measured time series with shorter duration are also useful, although not securing optimal parameter values. In such case it is important that the time series represents different hydrological situations, i.e. typical wet period or dry period.

An exact correspondence between simulations and measurements can however not be expected and for areas where precipitation data of worse quality is used, a less accurate calibration result must be accepted. In this case it may be preferable to recall the purpose of the actual model application and concentrate on calibrating yearly volumes, flow peaks or base flows, depending on what kind of analysis is to be performed with the model.

It must be remembered that RDI calculates the precipitation-dependent flow component. When comparing with measured discharge data the total measured discharge therefore has to be reduced with the flow components not being precipitation dependent, e.g. foul flow.

RDI calculates the total generated discharge from a catchment, i.e. overflow within the sub-catchment will also be included in the calculated discharge. Therefore, when comparing with measured peak flows and controlling the water balance (total volume) this has to be taken into consideration.



In principle, the model validation is concerned about comparison of the computed and measured hydrographs. As there are almost an infinite number of possibilities to describe level of agreement between two hydrographs, it is recommended to establish some validation criteria, i.e. a measure for accuracy of the model, relevant for the current application. There are several types of criteria, such as numeric criteria based on single values (e.g. peak discharge, volume, etc.), or more complex numeric criteria based on statistical analysis of the computed and calculated time series. Also, there are different types of visual criteria, based on visual inspection, e.g. comparison of graphic presentations of the calculated and measured duration curves. An important issue is to find the most appropriate criteria for the intended application of the model.

The choice of criteria is important since it may affect the final choice of parameter values and by that the behaviour of the calibrated model. Numerical criteria are, however, limited and therefore a visual comparison between the hydrographs is indispensable.

Comparison between the simulated runoff and the observed discharge time series may be obtained in the 'Calibrations | Plots and statistics' view.

## Surface runoff model

When simulating storm sewer systems or fully combined systems, usually a good estimation of the area drained by the FRC component (impervious areas, etc.) can be obtained from physical data (maps, etc.). The final model verification of a FRC should however be based upon comparison with measured discharges during rainfall.

To separate the Afrc component (Surface Runoff Model) and the fast part of the SRC component (Surface Runoff Component in RDI), measured discharge data with fairly high resolution in time (hours) is required.

For calibration of the parameters describing the response of the discharge (e.g. tc and TAtype for model A, or M, L and S for model B), a very high resolution in time is usually required, from minutes to hours.

## General hydrological model - RDI

It is not possible to determine the RDI parameters from geophysical measurements, since most of the parameters are of empirical nature. It is therefore necessary that measured discharge from the studied area is available, so that the RDI parameters can be determined by comparison between simulated and measured discharge through the calibration procedure.

The introductory calibration is performed visually by comparing simulated and measured discharge. The final optimization of the parameters is thereafter performed preferably using different numeric and graphical criteria.



The effects of changing each particular parameter are discussed below. Also, the most suitable hydrological periods for calibrating certain parameters are identified, which implies that a certain parameter affects the model behaviour more during periods with specific hydrological conditions. Usually, effects will also be obtained during other periods, why these should also be studied when adjusting a parameter.

The parameters are discussed in the preferable order of adjustment. However, it may be necessary to return to the previous calibration step, as well as repeating the whole process several times. It is recommended, especially for less experienced users, that only one parameter is changed at a time (i.e. for each calculation), so that the effect of the adjustment will appear clearly.

Sometimes, however, the effect of changing one parameter is not sufficient. Then, several parameters controlling similar phenomena can be adjusted together.

In some other cases, undesired secondary effects can be obtained when adjusting certain model parameter. These effects can often be eliminated by simultaneously adjusting other parameters, which do not influence the desired effects, but reduce secondary effects induced by the first parameter.

The following sequence of action is recommended:

- The first step in the RDI calibration is usually to adjust the water balance in the system, i.e. the accuracy between the calculated and measured total volume during the observed period. This is done by correcting the proportion of area,  $Asrc$ . An increase of  $Asrc$  proportionally increases every flow component at each time step.

The total volume generally also contains the runoff from impervious areas (Surface Runoff Model).

- Next, the overland flow coefficient CQOF is adjusted to obtain a correct distribution of volume between overland flow (peak flows) and baseflow. This is done after wet periods and preferably for a period with low evaporation.

A reduction of CQOF reduces the overland flow and increases the infiltration, i.e. induces increase in the baseflow.

The measured flow peaks generally also contain the runoff from impervious areas (Surface Runoff Model).





- CKBF is adjusted against the response of the baseflow, i.e. the build-up and regression of the baseflow. Adjustment against the build-up of baseflow is done during and after wet periods with low evaporation. Adjustment against regression is done during the start of dry periods with high evaporation, preferably when baseflow is the only flow component.

An adjustment of CKBF does not influence the size of the discharged volume studied for a longer period, but displaces the volumes in time.

- CKOF is adjusted against the response, i.e. the shape of the peak flows. This is done during periods with heavy rainfall, preferably after a wet period.

The measured flow peaks generally also contain the runoff from impervious areas (Surface Runoff Model).

- A reduction of  $U_{max}$  reduces the actual evapotranspiration, the process responsible for reduced discharges during period with high potential evaporation. The effect of reducing  $U_{max}$  will be largest for periods preceded by a wet period. Additionally, an increased overland flow is obtained, as well as more water transported to the groundwater storage resulting in an delayed effect of increased baseflow, because of the long response time of baseflow.

An important behaviour of the RDI model is that the surface storage must be filled-up before overland flow and infiltration, respectively, occur. Therefore, during dry periods with high potential evaporation,  $U_{max}$  can be estimated from how much rainfall is required for filling-up the surface storage, i.e. generating overland flow. The same methodology can also be used for the periods with low potential evaporation, but only if the rain event is preceded by a long dry period.

- CKIF is adjusted against the response of interflow during periods with low potential evaporation. A reduction of CKIF will result in a small increase in volume during these periods.
- The relative water content in the unsaturated zone (i.e. root-zone),  $L/L_{max}$  controls several of the different water transports in the RDI model. Since the storage capacity,  $L_{max}$ , influences the velocity of the filling of  $L$  towards  $L_{max}$ ,  $L_{max}$  is adjusted during periods of heavy filling of the root zone storage. This usually occurs during periods with low potential evaporation preferably in combination with a wet period.

A reduction of  $L_{max}$  increases the discharge, but it may decrease a little during period with very high potential evaporation.



- The threshold values indicate at which relative water content in the root zone,  $L/L_{max}$ , overland flow, interflow and baseflow respectively will be generated. Therefore, the threshold values can be estimated from the time of filling the root zone storage when each flow component starts discharging.

The threshold values have no effect during periods when the root zone storage is full,  $L = L_{max}$ .

An increased threshold value reduces the discharge during dry periods and in the beginning of wet periods, i.e. periods with low relative water content in the root zone storage.

TG is adjusted during periods with heavy filling of the root zone storage, preferably in combination with low potential evaporation and preceded by a dry period. TG is therefore an important parameter for adjusting the increase of the groundwater level in the beginning of wet periods.

TOF is adjusted after a dry period at events with heavy filling of the root zone storage. For example adjustment can be done for events where even larger rainfall volumes does not generate overland flow.

TIF is adjusted after a dry period when filling of the root zone storage, preferably in combination with low potential evaporation. However, TIF is one of the less important parameters.

- The degree-day-coefficient,  $C_{snow}$  can be estimated from analysis of the relation between temperature, water content in the snow storage and measured discharge. When temperature is below zero, the precipitation is stored in the snow storage. When temperature is above zero the content in the snow storage is emptied into the surface storage, where the velocity of emptying is controlled by  $C_{snow}$ . An increase of  $C_{snow}$  increases the emptying procedure.

This process should be addressed now and then during the whole calibration procedure. Otherwise, there is a risk that a snow-melting phenomenon is attempted to be described through adjusting other parameters.



- The Carea coefficient establishes the ratio of groundwater catchment and surface catchment (per Default, the two surfaces are equal). By changing the ratio, the ratio between the baseflow and other runoff components is correspondingly changed.

The Default values of the remaining RDI parameters: Sy (specific yield of the groundwater reservoir), GWLmin (minimum groundwater depth), GWLBF0 (maximum groundwater depth causing baseflow) and GWLFL1 (groundwater depth for unit capillary flux) are adjusted only in exceptional cases. Therefore, these parameters have been included into the RDI parameter set dialog in a separate box. The effects of changing the Default values should be well understood prior to adjustment.

Since the variation of water contents in the surface and root zone storage controls many of the other processes, they should be studied continuously throughout the calibration procedure.

Monthly and yearly values for the different processes, e.g. precipitation volume, real evaporation and total discharge, are written to an ASCII file, NAMSTAT.TXT after every RDI calculation. It is recommended that the content of this file is studied now and then during the calibration procedure.

## Overflow within the model area

In cases when overflow occurs in the model area, e.g. when simulating the discharge to the treatment plant, this has to be considered when calibrating the peak flows during rainfall. RDI calculates the total generated discharge in the catchment area and is therefore not able to describe hydraulic processes like e.g. overflow (loss of water). Calibration of parameters affecting the volume in the peak flows should therefore be performed for rain events when overflow is unlikely to occur. Model parameters affecting the response of the discharge for rain events when overflow occur can be calibrated against the peak flows base or width.

A well-calibrated RDI model can therefore be used for a rough estimation of overflow volume by studying the difference between calculated and measured discharge for heavy peak flows. The credibility for such estimation is however strongly affected by the quality of measured precipitation and discharge time series.

## Non-precipitation dependent flow components

RDI calculates the precipitation dependent flow component. Therefore, both for calibration and validation, other flow components should be treated outside RDI.

Examples of non-precipitation dependent flow components are foul flow and sea water leaking into the sewer system.



The foul flow is preferably estimated through daily values from produced water volumes weighted with yearly charged water volumes. This will however only give a rough estimate, and departure from this methodology may be necessary, e.g. for areas where a large amount of freshwater is used for irrigation.

The amount of leaking sea water is preferably estimated through an iterative procedure between RDI calculation and studies of the difference between the calculated and measured discharge. Only a rough estimation can be achieved, and less accurate calibration results may have to be accepted.

Specially, during the calibration procedure it is very important that non-hydrological errors are generally kept at the lowest level possible in the flow series used. Otherwise, there is a risk of hydrological interpretations of these errors, and the error transmitting in the model and increasing when simulating extreme hydrological situations. A typical example is a rough resolution in time for the foul flow component. The method described above should give a sufficiently correct description for most cases.

#### 4.2.7 Land uses

Land uses can optionally be used to define loss and infiltration settings varying as a function of the land use distributions on the catchments. This method is only available in combination with the following hydrological models:

- Time-Area (A)
- Kinematic wave (B)
- Linear Reservoir (C1)
- Linear Reservoir (C2).

The 'Land uses' editor holds loss and infiltration properties only. Relevant land uses then need to be selected for each catchment individually, and the percentage of the catchment coverage for each land use also needs to be specified in the 'Catchments' editor.

New land uses can be added using the 'Insert' button, or removed using the 'Delete' button. After inserting a new land use, a description ID should be specified.



Figure 4.30 The 'Infiltration' tab in the 'Land Uses' editor



Note: Land uses on the catchment may also be modelled with the RDI hydrological model. In this specific case, the land use is described with a RDI parameter set instead.

## Surface

In the 'Surface' tab, two types of initial losses can be applied to the land use:

- **Wetting loss:** this is a discontinuous loss, which happens as a first loss process. When precipitation starts, a part of the precipitation is used for wetting of the surface if the surface is initially dry. When wetting loss storage is filled, wetting loss process does not happen. It is not possible to infiltrate from wetting loss storage and the storage is recovered only by process of evaporation.
- **Storage loss:** this is the loss due to filling of the depressions and holes in the terrain. The model begins with the surface storage calculation after the wetting process is completed. The surface storage is filled only if the current infiltration rate is smaller than the actual precipitation intensity reduced by evaporation.

The roughness of the surface must also be specified with a Manning coefficient, which is a routing parameter. This Manning coefficient is only used in combination with the Kinematic wave (B) hydrological model to calculate the runoff of every individual surface / land use.

## Infiltration

In the 'Infiltration' tab, three methods are available to characterize the infiltration for the land use:



- No infiltration
- Horton infiltration: this method is parametrized using:
  - Minimum infiltration rate: infiltration rate at the end of the infiltration process.
  - Maximum infiltration rate: infiltration rate at the start of the infiltration process.
  - Exponent for wet conditions: a time factor that determines the dynamics of the infiltration capacity rate reduction over time during wet period. The actual infiltration capacity is made dependent of time since the rainfall start only.
  - Exponent for dry conditions: a time factor defining the rate of the soil infiltration capacity recovery after a rainfall, i.e., in a drying period.
- Green-Ampt infiltration: this method is parametrized using:
  - Saturated conductivity: hydraulic conductivity of fully saturated soil.
  - Max soil moisture deficit: parameter describing how dry the soil can become.
  - Average capillary suction: parameter describing capillary suction force as a head.

## Description

In this tab, a free description text can optionally be provided to describe the land use.

## 4.3 Catchment Connections

In order to transfer the runoff generated on catchment surfaces into the collection network, the model must include information about the connection of the catchment outlet to the collection network. One or multiple catchments can be connected to one node, and a catchment can be connected to multiple nodes.

In order to use Catchments in the context of network modeling, they have to be connected to the network.

MIKE+ supports the connection of catchments to multiple locations (i.e. nodes or links), as well as separately allocating runoff and catchment discharges to multiple locations.

### 4.3.1 Catchment Connections Overview

An overview of relevant connections to a pipe network for catchments is available in the Catchments Editor Catchment Connections Overview Tab (Catchments|Catchments). It shows a table summarizing the connections of the catchment to the network model. The data dynamically link and refer to



records in the Catchment Connections Editor (Catchments|Catchment Connections).

The summary table shows information on the following:

- Location. To which type of network element the catchment is connected, and the ID of the element.
- Catchment Runoff. Percentage of the Catchment Runoff from the catchment entering a location.
- Catchment Discharge. Percentage of the Catchment Discharge from the catchment entering a location.
- Action. Offers options for editing or adding connections for the active catchment.

**Edit.** Opens the Catchment Connections Editor, wherein attributes for the existing catchment connection entry can be modified.

**Add connection.** Adds a connection for the active catchment. The new connection is reflected in the overview table and the Catchment Connections Editor.

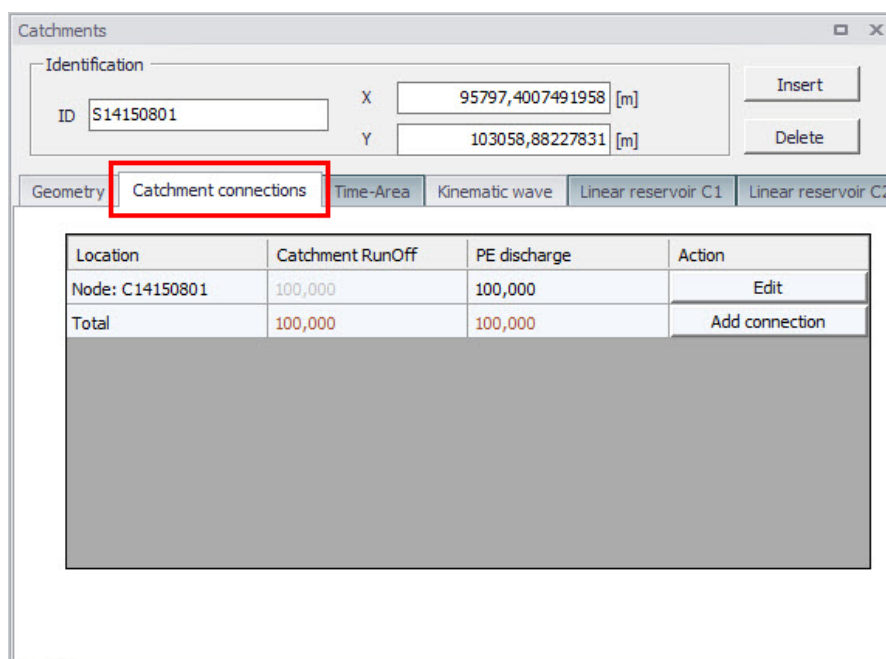

Figure 4.31 The Catchments Editor Catchment Connections Overview Tab

## 4.3.2 Catchment Connections Editor

Connect catchments to the pipe network via the Catchment Connections Editor (Catchments|Catchment Connections).

The definition and management of catchment connections is supported both through Editors and by a set of graphical catchment connection tools.

ID	Catchment ID	Type	Node/Storage ID	Link ID	Start chainage [m]	End chainage
1	imp74	Node	SWMH1795			
2	perv74	Node	SWMH1795			
3	imp85	Node	SWMH2263			
4	perv85	Node	SWMH2263			
5	imp8	Node	SWMH1761			
6	perv8	Node	SWMH1761			
7	imp70	Node	SWMH1795			
8	perv70	Node	SWMH1795			
9	imp148	Node	SWMH1782			

Figure 4.32 The Catchment Connections Editor

Create catchment connections through the 'Insert' button. Multiple connections for a single catchment can be set up.





Table 4.22 The Catchment Connections Editor attributes (Table msm\_CatchCon)

Edit field	Description	Usage	Attribute Table Field
Catchment ID	Unique catchment identifier	Yes	CatchmentID
Location Type radio buttons	Specifies the type of network element to which the catchment is connected. Options are: Node Entire link, or Link chainage	Yes	TypeNo
Node ID	Unique identifier for the connected node	Yes, If Connection Type = Node	NodeID
Link ID	Unique identifier for the connected link	Yes, If Connection Type = Entire link or Link chainage	LinkID
Chainage start/end	Start and end chainages of the connected link	Yes, If Connection Type = Link chainage	StartChainage/EndChainage
Load Type dropdown menu	Parameter that defines how the loads from the catchment are allocated to the pipe network for a connection. Options are: Standard, Wastewater Total, Stormwater Total, Combined Partial, Wastewater Partial, and Stormwater Partial. These different Load Types are further explained in the text below.	Yes	LoadTypeNo
Fraction of Catchment Runoff	Fraction of the catchment stormwater runoff to allocate for the connection	Optional, If Load Type = Combined Partial or Stormwater Partial	RRFraction
Fraction of Catchment Discharge	Fraction of the catchment discharge to allocate for the connection	Optional, If Load Type = Combined Partial and Wastewater Partial	PEFraction
Runoff routing method		Yes	RoutingTypeNo



Table 4.22 The Catchment Connections Editor attributes (Table msm\_CatchCon)

Edit field	Description	Usage	Attribute Table Field
Delay parameter	Time for the runoff to travel to the network connection location.	Yes if Muskingum routing is chosen	RoutingDelay
Shape parameter	A dimensionless factor controlling the shape of the modified hydrograph. This factor depends on the shape of the modelled wedge storage and must be between 0 and 0.5.	Yes if Muskingum routing is chosen	RoutingShape
Description	Optional description of the catchment connection	No	Description

As a catchment can be the source of multiple load types (i.e. stormwater and wastewater), and can be connected to multiple network elements and network types, qualifying a load connection type into clear categories according to pipe network type and connection options is important. These Load Types are described in more detail below:

- **Standard:** This type of load connection applies to combined systems where all the catchment output is connected to a single location. This is the Default type, which corresponds to the MIKE URBAN Classic Single Node connection type.
- **Wastewater Total:** This type of load connection applies to fully separated systems, where the catchment is connected to a single location in the wastewater network.
- **Stormwater Total:** This type of load connection applies to fully separated systems where the catchment is connected to a single location in the stormwater network.
- **Combined Partial:** This type of load connection applies to combined systems where the catchment is connected to multiple locations in a combined network. This is the fully versatile connection type.
- **Wastewater Partial:** This type of connection applies to fully separated systems, where the catchment is connected to multiple locations in a wastewater network.
- **Stormwater Partial:** This type of connection applies to fully separated systems where the catchment is connected to multiple locations in a stormwater network.

The User's choice of Load Type affects the Catchment load allocation Editor fields and the internal data validation.

A facility for data validation checks that for each catchment in the Catchment Connections Editor, the sum of the fractions for Catchment Discharge (i.e.



PEFraction) and Runoff Discharge (i.e.RRFraction) is close to 100 (99.9<sum<100.1).

For catchments where this sum is not found to be close to 100%, all specified connections will be reported as faulty and marked in red.

In the 'Routing' tab, it is possible to activate Muskingum routing along the catchment connection. When no runoff routing is applied, the runoff hydrograph entering the network matches the runoff hydrograph computed on the catchment. If Muskingum routing is applied, a change in hydrograph appearance occurs. This routing is designed to take into account the parts of the network between the catchment and the point of connection on the network, which are not included in the network model. This is especially relevant when the network is trimmed using the 'Network simplification' tool, in which case some parts of the network are removed and the neighboring catchments are reconnected to network locations further away, therefore neglecting parts of the flow path. The runoff routing in catchment connections can be activated automatically for reconnected catchments, while running the 'Network simplification' tool.

When the Muskingum method is selected, the two additional parameters below must also be specified:

- Delay parameter: time for the hydrograph to travel between the catchment and the connection location on the network. Its value may also be estimated as the observed travel time of the flood peak between the nodes.
- Shape parameter: a dimensionless factor controlling the shape of the modified hydrograph. This factor depends on the shape of the modelled wedge storage and must be between 0 and 0.5. If the shape parameter is set to zero, then the Muskingum routing will be very similar to linear reservoir routing.

## 4.4 Low Impact Development (LID)

Water sensitive urban design (WSUD) represents an approach to land development (or redevelopment) that works with nature to manage stormwater as close to its source as possible. It is also known as Low Impact Development (LID).

Low Impact Development employs principles such as preserving and recreating natural landscape features, minimizing effective imperviousness to create functional and appealing site drainage that treat stormwater as a resource rather than a waste product.

Many practices have been used to adhere to these principles such as bioretention facilities, rain gardens, vegetated rooftops, rainwater tanks, and permeable pavements. By implementing LID principles and practices,



stormwater can be managed in a way that reduces the impact of impervious built-up areas and supports the natural movement of water within an urban ecosystem or catchment.

Applied on a broad scale, LID can maintain or restore a catchment's hydrologic and ecological functions. LID has been characterized as a sustainable stormwater practice.

The ability to assess the benefit of LID practices installed in urban catchments is required by Water Utilities and other stakeholders responsible for the urban drainage. An essential part of this requirement is the ability to model the various LID practices at both hydrological screening level and at a detailed hydraulic level in order to evaluate the effect of installing LID practices as parts of a stormwater drainage system.

This chapter describes the implementation and development of model support of various LID structures in MIKE+.

The modelling of LID practices is divided into 2 main approaches:

- Modelling of LID at screening level - catchment-based approach
- Detailed hydraulic modelling of individual LID structures - drainage network based approach.

This method will provide the User with the option of detailed modelling of individual LID structures hydraulically connected to the stormwater pipe network. This approach is based on the concept of soakaway nodes.

In this Chapter, the MIKE+ implementation of LID at the screening level - the catchment-based approach - is explained.

The catchment-based methods implemented in MIKE+ are dominantly based on research published by US EPA, adapted appropriately to the MIKE+ modelling concept of urban hydrology. In the US, the term Low Impact Development Systems (LIDS) is used for WSUD and the LID concept provides the Users with an overall method for evaluating the various LID controls such as bioretention cells, rain gardens, green roofs, infiltration trenches, permeable pavements, rain barrels/rainwater tanks and vegetative swales.

A user-defined number of LID controls can be deployed and assessed for each individual catchment. This catchment-based approach is used to size the required infiltration or rainwater harvest by subtraction of flow from the calculated runoff within each catchment.

Please be aware that modelling of LID practices in MIKE+ is allowed for the Kinematic Wave runoff model (Model B) and runs with the MIKE 1D engine, exclusively.



LIDs are low impact development structures designed to capture or reduce surface runoff from the collecting area by means of a combination of detention, infiltration and evapotranspiration. Low Impact Development controls are conceptual objects that are not displayed on the map visualization of the urban catchment model. Once deployed, they are considered as properties of a given sub-catchment. MIKE+ can model seven types of LIDs:

1. Bioretention Cells
2. Infiltration Trenches
3. Porous Pavement
4. Rain Barrels
5. Vegetative Swales
6. Rain Garden
7. Green Roof

Bioretention cells, infiltration trenches, and porous pavement systems can have optional underdrain systems in their gravel storage beds to convey storage runoff off the site rather than infiltrate it all. They can also have an impermeable floor of liner that prevents infiltration into the native soil. Infiltration trenches and porous pavement systems can also be subject to a decrease in hydraulic conductivity over time due to clogging.

While some LID practices can also provide important pollutant reduction, the current LID implementation in MIKE+ can only be used to model the LIDs' quantitative hydrologic performance.

#### 4.4.1 Bioretention Cells

*Bioretention Cells* are terrain depressions that comprise of selected types of vegetation, resistant to the extended periods of high moisture and extreme levels of nutrient concentrations (Nitrogen and Phosphorus) found in storm-water runoff, grown in an engineered soil mixture above a gravel drainage bed. They provide storage, infiltration and evaporation of both direct rainfall and runoff captured from the collecting area surrounding the cell. Rain gardens, street planters, and green roofs are all different types of bioretention cells.

The different structural layers of this feature are:

- Surface
- Soil
- Storage
- Drain (underdrain)

These are illustrated in Figure 4.33. There are one or several relevant hydrological processes associated with each layer.

In the surface occur surface storage, surface infiltration, the collecting area run-on, surface evaporation and overflow.

In the soil layer occur percolation (vertical water movement to the storage layer), evapotranspiration (loss due to the plant root action) and storage in the soil's voids.

In the storage layer, stormwater provided by the percolation through the soil layer is detained in the storage layer's voids. Infiltration (leakage) to the native soil through the storage bottom, controlled by the characteristics of the surrounding soil, restores the storage capacity.

An optional underdrain may be included to empty the storage. The underdrain is activated (with the specified capacity) when the water level in the storage reaches the offset level.

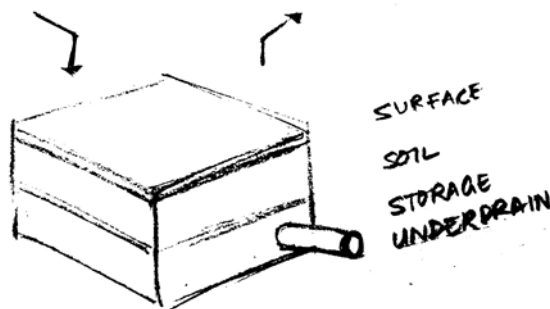

Figure 4.33 Bioretention cell structure layers

## 4.4.2 Infiltration Trenches

*Infiltration Trenches* are storage cells filled with gravel that capture runoff from upstream impervious areas. They provide storage capacity and the possibility for captured runoff to infiltrate the soil underneath.

Figure 4.34 illustrates an infiltration trench structure showing the following components:

- Surface
- Storage
- Drain (optional underdrain)



The processes simulated for the infiltration trench are similar as for bioretention cells, except for the missing soil layer; stormwater from the surface enters the storage directly, i.e. without detention in the soil layer.

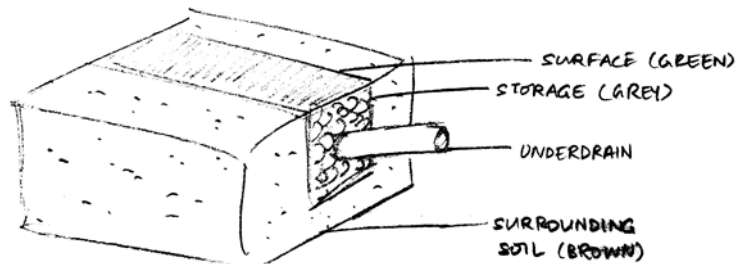

Figure 4.34 Infiltration trench structure layers

### 4.4.3 Porous Pavement

*Porous Pavement* systems are excavated areas filled with gravel and paved over with a porous concrete or asphalt mix. Porous pavements are implemented in places where the surface has to provide a firm support for vehicle traffic, such as streets and parking lots.

Normally, all rainfall will immediately pass through the pavement into the gravel storage layer below where it can infiltrate at natural rates into the native soil.

Figure 4.35 shows a porous pavement structure, which has the following components:

- Surface
- Pavement material
- Storage
- Drain (underdrain)

Essentially, hydraulic functionality of the porous pavement is similar to that of the bioretention cell, except that the soil layer (and vegetation) are replaced by some porous asphalt or concrete.

Some types of porous pavements may be subject to clogging by fine sediment particles, which reduces their infiltration capacity.

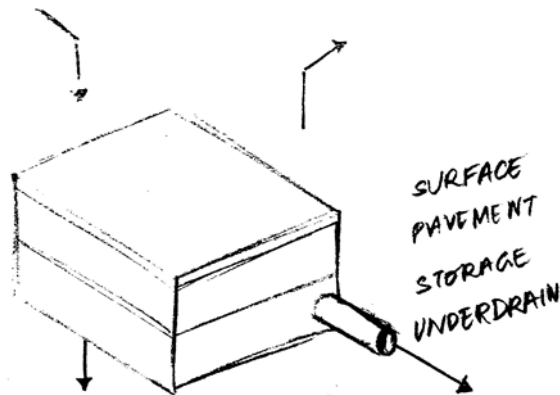

Figure 4.35 Porous Pavement structure layers

#### 4.4.4 Rain Barrels

*Rain Barrels* are containers that collect roof runoff during storm events and can either release or re-use the rain water during dry periods.

A rain barrel includes:

- Storage (with total porosity, i.e. empty volume)
- Drain (underdrain)

The processes simulated include water detention in the storage, overflow and drainage (i.e. storage recovery). The action of the underdrain is timed; the time offset between the end of rain and the drain activation can be specified. This feature allows for the simulation of rainwater reuse for garden watering, which normally takes place several hours or days after the rain has stopped.

A conceptual sketch of a rain barrel is presented in Figure 4.36.



Figure 4.36 Rain Barrel





#### 4.4.5 Vegetative Swales

*Vegetative Swales* are waterways or depressed areas with sloping sides covered with grass and other vegetation. They slow down the conveyance of collected runoff and allow it more time to infiltrate to inherent soil beneath it. The only relevant layers regarding vegetative swales are:

- Surface (and surrounding soil)

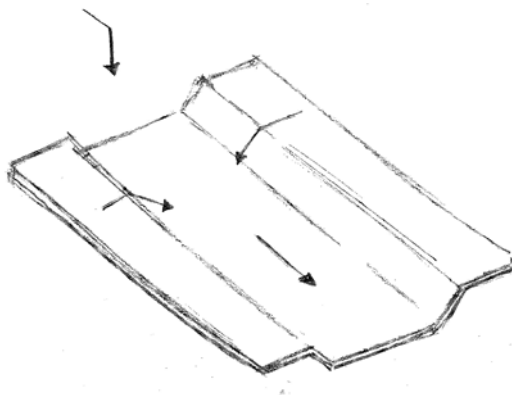

Figure 4.37 Vegetative Swale layer structure

#### 4.4.6 Rain Garden

*Rain Garden* is a simplified form of bioretention cell, which takes advantage of rainfall and stormwater runoff in its design, simultaneously contributing to the reduction of runoff volume and pollutants released from the site. Typically, it is designed as a small garden with selected types of vegetation resistant to the extended periods of high moisture and extreme levels of nutrient concentrations (Nitrogen and Phosphorus) found in stormwater runoff.

The different layers comprising rain gardens are presented in Figure 4.38. These include:

- Surface
- Soil layers

Surface storage, surface infiltration, the collecting area run-on, surface evaporation, and overflow occur on the surface.

In the soil layer occur storage in the soil's voids, evapotranspiration (loss due to the plant root action) and infiltration (leakage) to the native surrounding soil through the bottom. The infiltration is controlled by the characteristics of the surrounding soil.

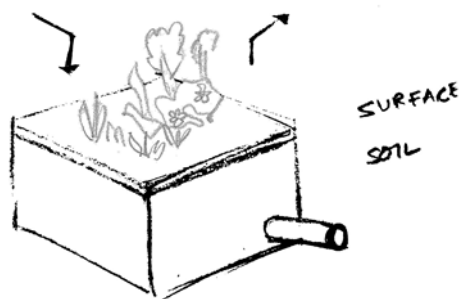

Figure 4.38 Rain Garden process layers

#### 4.4.7 Green Roof

*Green Roofs* are structural components that reduce the negative effects of urbanization on water quality and rainfall runoff by absorbing or detaining, and filtering runoff. They are built of a planted lightweight soil media and a drainage layer, and have the following components:

- Surface
- Soil
- Drainage Mat

Green Roofs may be designed with intensive or extensive vegetation cover. Intensive green roofs are heavy, with soil media layers larger than 15 cm. Extensive green roofs may include a soil layer as thin as 3 cm, affecting the choice of vegetative cover.

Green roofs are equipped with a drainage layer called a drainage mat placed beneath the soil media. The purpose of the drainage mat is to conduct the surplus water percolated through the soil layer from the roof to the drainage system.

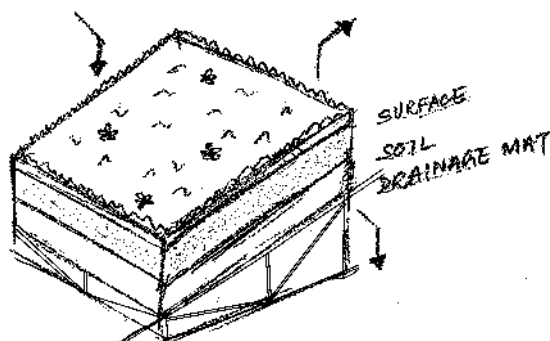

Figure 4.39 Green roof process layers



### 4.4.8 LID Properties Editor

The MIKE+ LID Properties editor organizes the data input for the different layers and functional elements of LID structures. The input data is organized into the following group and tabs:

- **Identification:** This group provides unique identification of the specified LID and definition of its type. Each individual LID is generic and is specified per unit area. As such, it can be replicated and placed in any sub-catchment of the study area (i.e. deployed) with different actual sizes and in any number of instances.
- **Tabs:** Surface, Soil, Pavement, Storage, Drain, and Drainage Mat. These tabs represent different layers and functional elements defining the structure of the LID. The properties of each layer and functional element, which constitute the actual LID type, are entered in these tabs. Only the relevant data fields for a LID type are activated and available for data input.

#### Identification

Table 4.23 The LID Properties Identification Group (Table msm\_LIDcontrol)

Edit field	Description	Used or required by simulations	Field name in data structure
ID	ID of LID	Yes	MUID
Type	Type of LID 1:Bioretention Cell 2:Porous Pavement 3:Infiltration Trench 4:Rain Barrel 5: Vegetative Swale 6:Rain Garden 7:Green Roof	Yes	LIDTypeNo

#### LID Properties

Figure 4.40 through Figure 4.45 illustrate the six tabs containing the data for various functional elements of LID structures. The corresponding parameter attributes in the msm\_LIDcontrol database table are summarised in subsequent tables divided by component following the tabs.

##### Surface

A Surface component is used for the following LID structures:

- Bioretention Cell



- Porous Pavement
- Infiltration Trench
- Vegetative Swale
- Rain Garden
- Green Roof

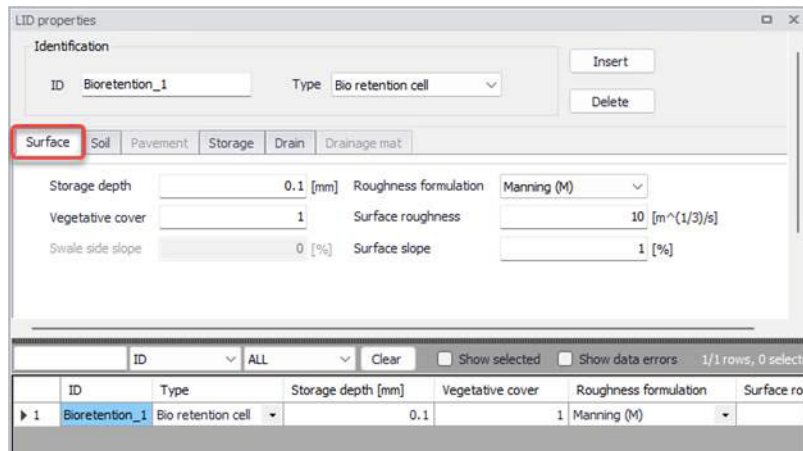

Figure 4.40 The LID Properties Editor Surface Tab



Table 4.24 LID Properties Surface tab attributes (Table msm\_LIDcontrol)

Edit field	Description	Used or required by simulations	Field name in datastructure
Storage Depth	When confining walls or berms are present, this is the maximum depth to which water can pond above the surface before overflow occurs. For LIDs that experience ponding it is the height of any surface depression storage. For swales, it is the height of its trapezoidal cross section.	Yes If LIDTypeNo = (1,2,3,5,7)	StorHt
Vegetative Cover	The fraction of the storage area above the surface that is filled with vegetation (0 = no vegetation, 1 = no storage available). NOTE: for infiltration trench, vegetative cover is typically non-existent	Yes If LIDTypeNo = (1,2,3,5,7)	VegFrac
Swale Side Slope	Slope (run over rise) of the sidewalls of a vegetative swale's cross section. Used for the calculation of the stored volume and wetted width. This value is ignored for other types of LIDs	Yes If LIDTypeNo=5	Xslope
Roughness formulation	Selects whether the roughness value is expressed as Manning (M) or Manning (n)	Yes	FricTypeNo



Table 4.24 LID Properties Surface tab attributes (Table msm\_LIDcontrol)

Edit field	Description	Used or required by simulations	Field name in datastructure
Surface Roughness	Manning's n or M (used in combination with surface slope and width) for routing of overflow from the surface of bioretention cell, rain garden, infiltration trench, porous pavement and for flow routing in vegetative swale (see Table 4.30 for typical values). If specified zero (for all types except vegetative swale), no routing of the overflow is applied	Yes If LIDTypeNo = (1,2,3,5,6,7)	Rough
Surface Slope	Slope (used in combination with surface roughness and width) for routing of overflow from the surface of bioretention cell, rain garden, infiltration trench, porous pavement and for flow routing in vegetative swale. If specified zero (for all types except vegetative swale), no routing of the overflow is applied	Yes If LIDTypeNo = (1,2,3,5,6,7)	Slope
Soil infiltration capacity	The rate of water moving from surface into the soil. It is characteristics of the surface and the uppermost soil layer (equivalent to Horton's initial infiltration capacity). Infiltration takes place at all times during a rain event and after, as long as there is water available as rainfall, as run on or as water stored in the surface.	Yes If LIDTypeNo = 5	InfiltrationCapacity



## Soil

A Soil component is used for the following LID structures:

- Bioretention Cell
- Rain Garden
- Green Roof

ID	Type	Storage depth [mm]	Vegetative cover	Surface roughness [m <sup>1/3</sup> /s]	Su
1	Bioretention_1	Bio Retention Cell	0,1	1	10

Figure 4.41 The LID Properties Editor Soil Tab



Table 4.25 LID Properties Soil tab attributes (Table msm\_LIDcontrol)

Edit field	Description	Used or required by simulations	Field name in datastructure
Thickness	Thickness of the soil layer. Typical values range from 450 to 900 mm for rain gardens, street planters and other types of land-based bioretention units, but only 75 to 150 mm for green roofs	Yes If LIDTypeNo = (1, 5, 6, 7)	SThick
Porosity	Volume of pore space relative to total volume of soil (as a fraction)	Yes If LIDTypeNo = (1, 5, 6, 7)	Por
Field Capacity	Volume of pore water relative to total volume held in the soil after excess water has drained away and the rate of downward movement has decreased (as a fraction). Vertical percolation of water through the soil occurs only when field capacity level is reached or exceeded.	Yes If LIDTypeNo = (1, 5, 6, 7)	FC
Wilting Point	Volume of pore water relative to total volume for a well-dried soil where only bound water remains (as a fraction). The moisture content of the soil cannot fall below this limit and wilting point cannot be higher than the Field Capacity level.	Yes If LIDTypeNo = (1, 5, 6, 7)	WP





Table 4.25 LID Properties Soil tab attributes (Table msm\_LIDcontrol)

Edit field	Description	Used or required by simulations	Field name in datastructure
Leakage Capacity	The rate of water leaving the soil layer into storage. It is characteristic of the soil layer. Leakage starts when soil storage exceeds field capacity, continues at all times while soil storage is above the field capacity.	Yes If LIDTypeNo = (1, 5, 6, 7) AND FlowMethod = 1 (Capacity-based)	LeakageCapacity
Infiltration Capacity	The rate of water moving from surface into the soil. It is characteristics of the surface and the uppermost soil layer (equivalent to Horton's initial infiltration capacity). Infiltration takes place at all times during a rain event and after, as long as there is water available as rainfall, as run on or as water stored in the surface.	Yes If LIDTypeNo = (1, 5, 6, 7)	InfiltrationCapacity
Conductivity	Hydraulic conductivity for the fully saturated soil. This is equivalent to leakage capacity	Yes If LIDTypeNo = (1, 5, 6, 7) AND FlowMethod = 2 (conductivity based))	Ksat



Table 4.25 LID Properties Soil tab attributes (Table msm\_LIDcontrol)

Edit field	Description	Used or required by simulations	Field name in datastructure
Conductivity Slope	Slope of the curve of log (conductivity) versus soil moisture content (dimensionless). Typical values range from 5 for sands to 15 for silty clay	Yes If LIDTypeNo = (1, 5, 6, 7) AND Flow-Method = 2 (Conductivity-based)	Kcoeff
Suction Head	The average value of soil capillary suction along the wetting front. This is the same parameter as used in the Green-Ampt infiltration model	Yes If LIDTypeNo = (1, 5, 6, 7) AND Flow-Method = 2 (Conductivity-based)	Suct

### Pavement

A pavement component is used for the following LID type:

- Porous Pavement

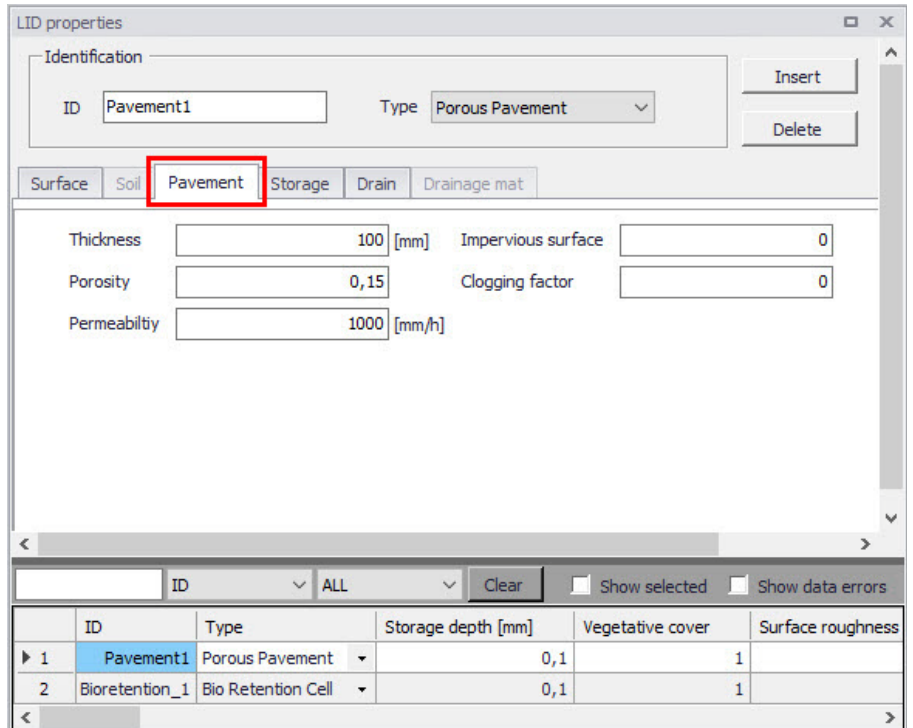

Figure 4.42 The LID Properties Editor Pavement Tab

Table 4.26 LID Properties Pavement tab attributes (Table msm\_LIDcontrol)

Edit field	Description	Used or required by simulations	Field name in data-structure
Thickness	Thickness of the pavement. Typical values are 100 to 150 mm	Yes If LIDTypeNo = 2	PThick
Porosity	The ratio (expressed as a fraction) of the volume of the pores or interstices of a material to the total volume of the pavement. Typical values range from 0.11 to 0.17 for pavements Note that porosity = void ratio/(1 + void ratio).	Yes If LIDTypeNo =2	PVPorosity



Table 4.26 LID Properties Pavement tab attributes (Table msm\_LIDcontrol)

Edit field	Description	Used or required by simulations	Field name in data-structure
Permeability	Permeability of concrete or asphalt used in continuous systems or hydraulic conductivity of the fill material (gravel or sand) used in modular systems. Permeability of new porous concrete or asphalt is high (>2450 mm/h), but over time the fine particles in the runoff tend to clog the pavement, reducing the permeability of the structure.	Yes If LIDTypeNo = 2	Perm
Impervious Surface	Ratio of impervious paver material to total area for modular systems; 0 for continuous porous pavement systems	Yes If LIDTypeNo = 2	FracImp
Clogging Factor	Voids that are clogged due to fine particles accumulation, as a fraction of total voids area. Use a value of 0 to ignore clogging. Max. value = 1.	Yes If LIDTypeNo = 2	PVClog

### Storage

A Storage component is used for the following LID structures:

- Bioretention Cell
- Porous Pavement
- Infiltration Trench
- Rain Barrel



LID properties

Identification

ID:  Type:

Insert  
Delete

Surface | Soil | Pavement | **Storage** | Drain | Drainage mat

Height:  [mm] Conductivity:  [mm/h]  
 Porosity:  Clogging factor:

< >

ID  Clear  Show selected  Show data errors

	ID	Type	Storage depth [mm]	Vegetative cover	Surface roughness
1	Pavement1	Porous Pavement	0,1	1	
▶ 2	Bioretention_1	Bio Retention Cell	0,1	1	

< >

Figure 4.43 The LID Properties Editor Storage Tab



Table 4.27 The LID Properties Storage tab attributes (Table msm\_LIDcontrol)

Edit field	Description	Used or required by simulations	Field name in datastructure
Height	The height of the storage layer in case of bioretention cell, porous pavement and infiltration trench; the height of a rain barrel (mm or inches). Crushed stone and gravel layers are usually 150 to 450 mm thick while rain barrels vary in height from 600 mm upwards.	Yes If LIDTypeNo = (1,2,3,4)	Height
Porosity	The ratio of the volume of the pores or interstices of a material to the total volume of the layer. Typical values range from 0.30 to 0.45 for gravel beds. Note that porosity = void ratio/(1 +void ratio).	Yes If LIDTypeNo = (1,2,3)	SVPorosity
Conductivity	The maximum rate at which water infiltrates to the surrounding soil through the bottom of the freshly constructed storage layer.	Yes If LIDTypeNo = (1, 2, 3)	Filt
Clogging Factor	Volume of voids that are clogged due to fine particles accumulation. Use a value of 0 to ignore clogging.	Yes If LIDTypeNo = (1,2,3)	SVclog



## Drain

A Drain component is used for the following LID structures:

- Bioretention Cell
- Porous Pavement
- Infiltration Trench
- Rain Barrel

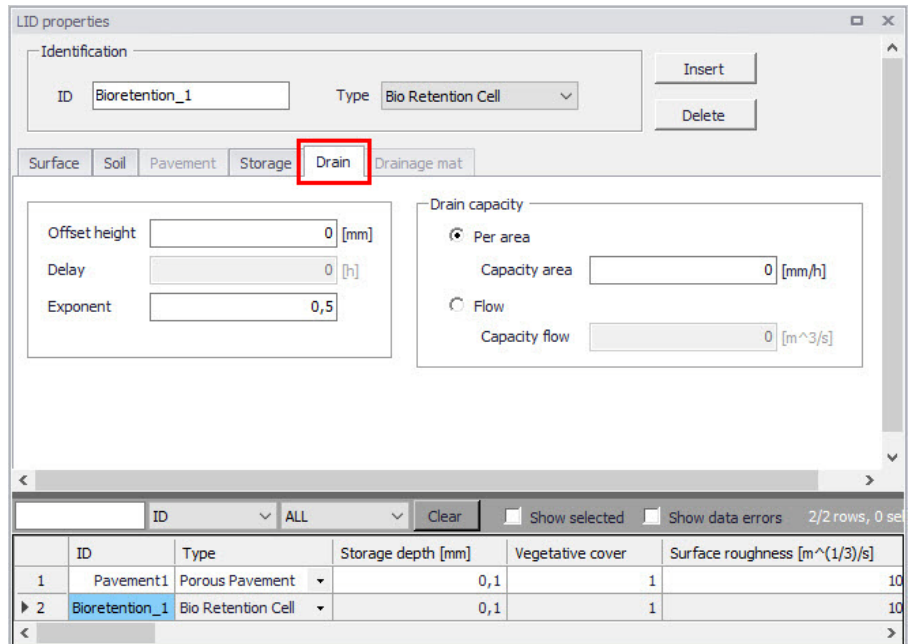

Figure 4.44 The LID Properties Editor Drain Tab

Table 4.28 The LID Properties Drain tab attributes (Table msm\_LIDcontrol)

Edit field	Description	Used or required by simulations	Field name in datastructure
Offset Height	Height of any underdrain piping above the bottom of a storage layer or rain barrel	Yes If LIDTypeNo = (1,2,3,4)	HOffset
Delay	The number of dry weather hours that must elapse before the drain in a rain barrel is activated	Yes If LIDTypeNo = 4	Delay



Table 4.28 The LID Properties Drain tab attributes (Table msm\_LIDcontrol)

Edit field	Description	Used or required by simulations	Field name in datastructure
Exponent	Exponent n that determines the rate of flow through the underdrain as a function of height of stored water above the drain height.	Yes If LIDTypeNo = (1,2,3,4)	Expon
Capacity Area	Coefficient that determines the rate of flow through the underdrain as a function of height of stored water above the drain bottom. Expressed in terms of flow capacity per area.	Yes If LIDTypeNo = (1,2,3,4) AND Drain Capacity = Per Area	DrainCapacityArea
Capacity Flow	Coefficient that determines the rate of flow through the underdrain as a function of height of stored water above the drain bottom. Expressed in terms of flow capacity.	Yes If LIDTypeNo = (1,2,3,4) AND Drain Capacity = Flow	DrainCapacityFlow

### Drainage Mat

A Drainage Mat component is used for the following LID structure:

- Green Roof



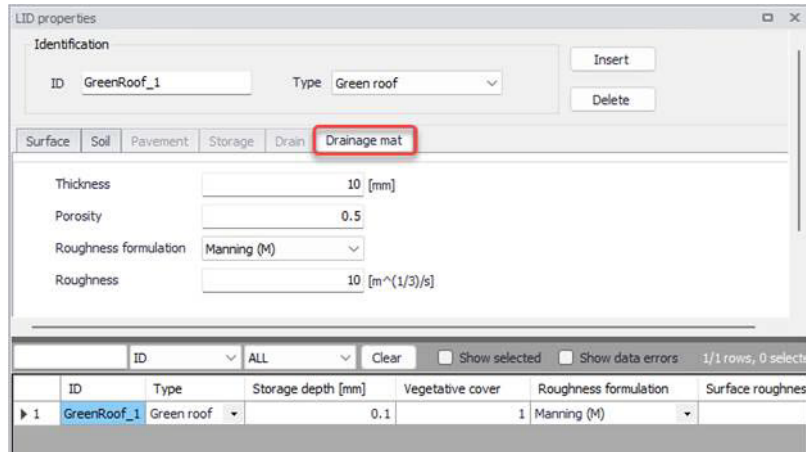

Figure 4.45 The LID Properties Editor Drainage Mat Tab

Table 4.29 The LID Properties Drainage Mat tab attributes (Table msm\_LIDcontrol)

Edit field	Description	Used or required by simulations	Field name in datastructure
Thickness	The thickness of the mat or plate. It typically ranges between 25 to 50 mm	Yes If LIDTypeNo = 7	DMThick
Porosity	The ratio of void volume to total volume in the mat. It typically ranges from 0.5 to 0.6	Yes If LIDTypeNo = 7	DMVPorosity



Table 4.29 The LID Properties Drainage Mat tab attributes (Table msm\_LIDcontrol)

Edit field	Description	Used or required by simulations	Field name in datastructure
Roughness formulation	Selects whether the roughness value is expressed as Manning (M) or Manning (n)	Yes	DMFricTypeNo
Roughness	Manning’s number, used to compute the horizontal flow rate of drained water through the mat. In absence of standard product specifications provided by manufacturers, the roughness must be estimated. Use of n values from 0.1 to 0.4 (M = 2.5 - 10) is suggested.	Yes If LIDTypeNo = 7	DMRough

Table 4.30 shows examples of Manning M values for different types of surfaces. Table 4.31 shows hydraulic conductivity properties for various porous media.

Table 4.30 Manning’s M of surface for porous pavement or vegetative swale <sup>a</sup>

Surface type	Manning M
Smooth asphalt	91
Smooth concrete	83
Ordinary concrete lining	77
Good wood	71
Brick with cement mortar	71
Vitrified clay	67
Cast Iron	67
Corrugated metal pipes	42
Cement rubble surface	42
Fallow soils (no residue)	20
Cultivated soils	50 to 20
Residue cover < 20%	17



Table 4.30 Manning’s M of surface for porous pavement or vegetative swale <sup>a</sup>

Surface type	Manning M
Residue cover > 20%	6
Range (natural)	8
Short, prairie	7
Dense	4
Bermuda grass	2
Woods	10
Light underbrush	2,5
Dense underbrush	1,25

a.Source: McCuen, R. et al. (1996), Hydrology, FHWA-SA-96-067, Federal Highway Administration, Washington, DC

Table 4.31 Hydraulic conductivity and porosity of unconsolidated porous media <sup>a</sup>

Material	Hydraulic conductivity K (cm/s)	Porosity $\eta$ (%)
Gravel	$10^{-1} - 10^2$	25 - 40
Sand	$10^{-5} - 1$	25 - 40
Silt	$10^{-7} - 10^{-3}$	35 - 50
Clay	$10^{-9} - 10^{-5}$	40 - 70

a. Source: Freeze, R.A., and Cherry, J.A., (1979), Ground-water, Prentice-Hall, Englewood Cliffs, NJ

### 4.4.9 LID Deployment

The LIDs are assigned to a catchment by means of the LID Deployment Editor. In this Editor, it is possible to specify the size (i.e. area) of the individual LID structure, the size of the catchment’s impervious area that is funnelled into it and the number of the current LID units.

The size properties can be specified either directly as surface area, or as a percentage of the catchment’s area. The specified total collecting area must not exceed the size of the catchment’s impervious area.

Furthermore, level of initial saturation and routing width for overland flow can be specified.

The input data is organized into the following groups:

- Identification
- Deployment Parameters

Figure 4.46 The LID Deployment Editor

## Identification

Each deployed LID is linked to a LID Deployment ID. I.e. each deployment represents a LID deployed on a single catchment in a specified number of units. For each LID deployment, a result file can be generated containing time series of relevant variables (fluxes and storages). This result file is in the DFS0 time series format.

A full reference of the attributes related to LID deployment is shown in Table 4.32 and Table 4.33.

Table 4.32 The LID Deployment Identification Group (Table msm\_LIDusage)

Edit Field	Description	Used or required by simulations	Field name in data structure
ID	Unique deployment ID	Yes	MUID
Catchment ID	Identification of the associated catchment	Yes	CatchID
LID ID	Identification of the LID structure to be deployed	Yes	LidID
Apply checkbox	Option for activating/deactivating deployment of a LID structure	Yes	IncludeNo

Including or excluding a LID is handled by the Active checkbox. This checkbox is checked by Default.



## Deployment Parameters

Table 4.33 The LID Deployment Properties (Table msm\_LIDusage)

Edit Field	Description	Used or required by simulations	Field name in datastructure
Number of Units	Number of replicate LID units deployed within the catchment	Yes	ReplicateNumber
Width	The width of the outflow face of each identical LID unit (meter or feet). This parameter is applied for all control units that use overland flow to transport surface runoff off the unit, being these roofs, pavement, trenches, and swales for the other control types this parameter can be set as 0	Yes (for porous pavement, swales, roofs and trenches)	Width
Area/% of Catchment Area options	Toggle for LID collecting area setting	Yes	CollectingNo
Unit Area	The surface area of each replicate LID unit	Yes If CollectingNo=Area	UnitArea
Collecting Area	A LID practice is connected to a tributary area whose runoff is treated by the unit. This area includes the LID practice area itself.	Yes If CollectingNo=Area	CollectingArea
% Unit Area	The surface area of each replicate LID unit, expressed as a percentage of the total catchment area	Yes If CollectingNo=% of Catchment Area	UnitAreaPercent
% Collecting Area	The tributary area connected to the LID unit presented as a percentage of the catchment	Yes If CollectingNo=% of Catchment Area	CollectingAreaPercent
Surface	Initial water content of the surface layer	Yes	InitSatSurface



Table 4.33 The LID Deployment Properties (Table msm\_LIDusage)

Edit Field	Description	Used or required by simulations	Field name in datastructure
Soil/Pavement	The degree to which the unit's soil is initially filled with water (0% saturation corresponds to the wilting point moisture).	Yes	InitSatSoil
Storage	Initial water content of the storage layer.	Yes	InitSatStorage

## LID Deployment Result File

Optionally, for each LID structure deployment, a DFS0 time series file can be created. This file includes time series of relevant variables inside the LID structure in terms of inflow, flow between layers, storage levels in various layers and output from the structure to the native soil.

If the User does not activate this option, the only visible outputs from the runoff simulation including LIDs are the changed (reduced) runoff hydrographs, caused by infiltration loss and storage in the LID structure, and the LID summary table in the simulation summary file.

The contents of the DFS0 file depends on the actual LID type. In Figure 4.47, an example of the DFS0 file for porous pavement is presented. Thirteen columns contain time series for the processes occurring inside the porous pavement.

**NOTE: The flow inside the LID structure and the drain flow are reported as intensities based on the LID area. In cases where the collecting area is bigger than the LID area, the reported intensities will not be comparable with rainfall and evapotranspiration intensities, which are given as the model boundary conditions. In order to make the comparison possible, the reported flow intensities must be scaled down by the ratio between the LID area and the collecting area.**



	1	2	3	4	5	6	7	8	9	10	11	12	13
	Time	Inflow [mm/h]	Rain [mm/h]	Evaporation [mm/h]	Infiltration [mm/h]	SurfaceFlow [mm/h]	DrainFlow [mm/h]	SurfaceDepth [m]	PavementMoisture [0]	StorageDepth [mm]	SurfaceToPavement [mm/h]	PavementToStorage [mm/h]	MassChecksum [m <sup>3</sup> ]
1	07-05-1994 16:36:00.000	0	1.2	0	0	0	0	0	0	0.4444444-005	1.2	1.2	1.734729e-018
2	07-05-1994 16:37:00.000	0	1.2	0	1.2	0	0	0	0	0.4444444-005	1.2	1.2	5.20417e-018
3	07-05-1994 16:38:00.000	0	1.2	0	1.2	0	0	0	0	0.4444444-005	1.2	1.2	5.20417e-018
4	07-05-1994 16:39:00.000	0	1.2	0	1.2	0	0	0	0	0.4444444-005	1.2	1.2	5.20417e-018
5	07-05-1994 16:40:00.000	0	1.2	0	1.2	0	0	0	0	0.4444444-005	1.2	1.2	5.20417e-018
6	07-05-1994 16:41:00.000	0	4.8	0	1.2	0	0	0	0	0.0001777778	4.8	4.8	1.214306e-017
7	07-05-1994 16:42:00.000	0	4.8	0	4.8	0	0	0	0	0.0001777778	4.8	4.8	1.900196e-017
8	07-05-1994 16:43:00.000	0	4.8	0	4.8	0	0	0	0	0.0001777778	4.8	4.8	1.900196e-017
9	07-05-1994 16:44:00.000	0	4.8	0	4.8	0	0	0	0	0.0001777778	4.8	4.8	1.900196e-017
10	07-05-1994 16:45:00.000	0	4.8	0	4.8	0	0	0	0	0.0001777778	4.8	4.8	1.900196e-017
11	07-05-1994 16:46:00.000	0	4.8	0	4.8	0	0	0	0	0.0001777778	4.8	4.8	1.900196e-017
12	07-05-1994 16:47:00.000	0.2571431	4.8	0	4.8	0	0	0	0	0.000173016	5.057143	5.057143	2.002050e-017
13	07-05-1994 16:48:00.000	0.2571431	4.8	0	0.857143	0	0	0	0	0.000253663	6.857143	6.857143	3.989864e-017
14	07-05-1994 16:49:00.000	0.2571431	4.8	0	0.857143	0	0	0	0	0.000253663	6.857143	6.857143	3.989864e-017
15	07-05-1994 16:50:00.000	0.2571431	4.8	0	0.857143	0	0	0	0	0.000253663	6.857143	6.857143	6.761422e-017
16	07-05-1994 16:51:00.000	0.2571431	0.2	0	0.857143	0	0	0	0	0.000214-005	0.2857143	0.2857143	7.83206e-017
17	07-05-1994 16:52:00.000	0.00571429	0.2	0	0.2857143	0	0	0	0	0.000214-005	0.2857143	0.2857143	7.979728e-017
18	07-05-1994 16:53:00.000	0.00571429	0.2	0	0.2857143	0	0	0	0	0.000214-005	0.2857143	0.2857143	7.979728e-017
19	07-05-1994 16:54:00.000	0.00571429	0.2	0	0.2857143	0	0	0	0	0.000214-005	0.2857143	0.2857143	7.979728e-017
20	07-05-1994 16:55:00.000	0.00571429	0.2	0	0.2857143	0	0	0	0	0.000214-005	0.2857143	0.2857143	7.979728e-017
21	07-05-1994 16:56:00.000	0.00571429	0.2	0	0.2857143	0	0	0	0	0.000214-005	0.2857143	0.2857143	7.979728e-017
22	07-05-1994 16:57:00.000	0.00571429	0.2	0	0.2857143	0	0	0	0	0.000214-005	0.2857143	0.2857143	7.979728e-017
23	07-05-1994 16:58:00.000	0.00571429	0.2	0	0.2857143	0	0	0	0	0.000214-005	0.2857143	0.2857143	7.979728e-017
24	07-05-1994 16:59:00.000	0.00571429	0.2	0	0.2857143	0	0	0	0	0.000214-005	0.2857143	0.2857143	7.979728e-017
25	07-05-1994 17:00:00.000	0.00571429	0.2	0	0.2857143	0	0	0	0	0.000214-005	0.2857143	0.2857143	7.979728e-017
26	07-05-1994 17:01:00.000	0.00571429	0.2	0	0.2857143	0	0	0	0	0.000214-005	0.2857143	0.2857143	7.979728e-017
27	07-05-1994 17:02:00.000	0.00571429	0.2	0	0.2857143	0	0	0	0	0.000214-005	0.2857143	0.2857143	7.979728e-017
28	07-05-1994 17:03:00.000	0.00571429	0.2	0	0.2857143	0	0	0	0	0.000214-005	0.2857143	0.2857143	7.979728e-017
29	07-05-1994 17:04:00.000	0.00571429	0.2	0	0.2857143	0	0	0	0	0.000214-005	0.2857143	0.2857143	7.979728e-017
30	07-05-1994 17:05:00.000	0.00571429	0.2	0	0.2857143	0	0	0	0	0.000214-005	0.2857143	0.2857143	7.979728e-017
31	07-05-1994 17:06:00.000	0.00571429	0.2	0	0.2857143	0	0	0	0	0.000214-005	0.2857143	0.2857143	7.979728e-017
32	07-05-1994 17:07:00.000	0.00571429	0.2	0	0.2857143	0	0	0	0	0.000214-005	0.2857143	0.2857143	7.979728e-017
33	07-05-1994 17:08:00.000	0.00571429	0.2	0	0.2857143	0	0	0	0	0.000214-005	0.2857143	0.2857143	7.979728e-017
34	07-05-1994 17:09:00.000	0.00571429	0.2	0	0.2857143	0	0	0	0	0.000214-005	0.2857143	0.2857143	7.979728e-017
35	07-05-1994 17:10:00.000	0.00571429	0.2	0	0.2857143	0	0	0	0	0.000214-005	0.2857143	0.2857143	7.979728e-017
36	07-05-1994 17:11:00.000	0.00571429	0.2	0	0.2857143	0	0	0	0	0.000214-005	0.2857143	0.2857143	7.979728e-017
37	07-05-1994 17:12:00.000	0.00571429	0.2	0	0.2857143	0	0	0	0	0.000214-005	0.2857143	0.2857143	7.979728e-017
38	07-05-1994 17:13:00.000	0.00571429	0.2	0	0.2857143	0	0	0	0	0.000214-005	0.2857143	0.2857143	7.979728e-017
39	07-05-1994 17:14:00.000	0.00571429	0.2	0	0.2857143	0	0	0	0	0.000214-005	0.2857143	0.2857143	7.979728e-017
40	07-05-1994 17:15:00.000	0.00571429	0.2	0	0.2857143	0	0	0	0	0.000214-005	0.2857143	0.2857143	7.979728e-017
41	07-05-1994 17:16:00.000	0.00571429	0.2	0	0.2857143	0	0	0	0	0.000214-005	0.2857143	0.2857143	7.979728e-017
42	07-05-1994 17:17:00.000	0.00571429	0.2	0	0.2857143	0	0	0	0	0.000214-005	0.2857143	0.2857143	7.979728e-017
43	07-05-1994 17:18:00.000	0.00571429	0.2	0	0.2857143	0	0	0	0	0.000214-005	0.2857143	0.2857143	7.979728e-017
44	07-05-1994 17:19:00.000	0.00571429	0.2	0	0.2857143	0	0	0	0	0.000214-005	0.2857143	0.2857143	7.979728e-017
45	07-05-1994 17:20:00.000	0.00571429	0.2	0	0.2857143	0	0	0	0	0.000214-005	0.2857143	0.2857143	7.979728e-017
46	07-05-1994 17:21:00.000	17.48571	40.8	0	0.2857143	0	0	0	0	0.00215873	58.28571	58.28571	3.016498e-016

Figure 4.47 Example of a result report DFS0 file per deployment (a porous pavement control)

- Time:** calendar time for the simulated time steps.
- Inflow (mm/h):** inflow to the LID unit given as a multiple of the rain intensity and the collecting area outside LID/LID area. It is the run-on from the collecting area outside the LID and rain on top of the LID unit. The run on represents the net rain on the impervious collecting area, i.e. with initial losses subtracted.
- Rain (mm/h):** input rain for the catchment containing the LID unit. This rain loads the LID area directly.
- Evaporation (mm/h):** this is a given parameter specified by the User by means of boundary conditions valid for the catchment as well as for the LID unit.
- Infiltration (mm/h):** infiltration from the LID unit to the surrounding native soil.
- Surface flow (mm/h):** surface water flow. Represents overland flow for vegetative swale; overflow for other LID controls
- Drain flow (mm/h):** water flow through the drain.
- Surface depth (m):** accumulated water on the surface expressed as the water height on the surface. Maximum value is the specified surface storage height.
- Soil moisture ():** presented as a fraction, relative to the total volume of the soil layer. Corresponds to the water that is held in the spaces between soil particles. Maximum soil moisture (i.e. full saturation) is equivalent to the specified soil porosity.



10. **Pavement moisture():** presented as a fraction, relative to the total volume of the porous pavement layer. Corresponds to the water that is held in the pavement's voids. Maximum pavement moisture (i.e. full saturation) is equivalent to the specified pavement porosity.
11. **Storage depth (m):** accumulated water in the storage layer expressed as the water height in the storage. Maximum value is the storage height.
12. **Surface to soil (mm/h):** infiltration from the surface layer to the soil layer expressed in mm/h.
13. **Surface to pavement (mm/h):** infiltration from the surface layer to the pavement layer expressed in mm/h.
14. **Soil to storage (mm/h):** : flow from the soil layer to the storage layer expressed in mm/h.
15. **Pavement to storage (mm/h):** flow from the pavement layer to the storage layer mm/h.
16. **MassChecksum (m<sup>3</sup>):** regards to the error check in the mass water balance per time step computed, a low value in the order of 1\*E-015 indicates an accurate internal flow estimation.

## LID Simulation Summary

The LID simulation summary is provided as part of the overall simulation summary HTML file. The summary table reports the volume balance for each LID deployment (see example in Figure 4.48).

Id	Inflow/runoff [m <sup>3</sup> ]	Rain [m <sup>3</sup> ]	Evaporation [m <sup>3</sup> ]	Infiltration [m <sup>3</sup> ]	Surface runoff [m <sup>3</sup> ]	Drain Outflow [m <sup>3</sup> ]	Initial Storage [m <sup>3</sup> ]	Final Storage [m <sup>3</sup> ]
Green_roof3	0,000	19,83	0,000	0,000	0,000	0,000	0,000	19,83
Vegetative_swale1	17,26	1,983	0,000	19,24	0,002	0,000	0,000	0,000
Vegetative_swale2	17,26	1,983	0,000	19,24	0,004	0,000	0,000	0,000
Vegetative_swale3	17,26	1,983	0,000	19,24	0,001	0,000	0,000	0,000
Bio_retention1	17,26	1,983	0,000	3,956	1,555	10,23	0,000	4,500
Bio_retention2	17,26	1,983	0,000	10,66	0,675	0,000	0,000	7,911
Bio_retention3	17,26	1,983	0,000	11,00	0,000	0,000	0,000	8,242
Bio_retention4	17,26	1,983	0,000	10,82	0,000	0,000	0,000	8,421
Bio_retention5	17,26	1,983	0,000	10,82	0,000	0,000	0,000	8,421
Rain_garden1	17,26	1,983	0,000	11,74	0,000	0,000	0,000	7,500
Rain_garden2	17,26	1,983	0,000	11,74	0,000	0,000	0,000	7,500
Rain_garden3	17,26	1,983	0,000	11,74	0,000	0,000	0,000	7,500
Rain_garden4	17,26	1,983	0,000	11,74	0,000	0,000	0,000	7,500
Porous_pavement1	0,000	19,83	0,000	19,83	0,000	0,000	0,000	0,000
Porous_pavement2	0,000	19,83	0,000	19,83	0,000	0,000	0,000	0,000
Porous_pavement4	0,000	19,83	0,000	19,83	0,000	0,000	0,000	0,000
Porous_pavement3	0,000	19,83	0,000	19,83	0,000	0,000	0,000	0,000
Rain_barrel2	19,18	0,000	0,000	0,000	9,177	9,900	0,000	1,000
Rain_barrel1	19,18	0,000	0,000	0,000	9,177	0,000	0,000	9,392
Infiltration_trench1	0,000	19,83	0,000	19,83	0,000	0,000	0,000	0,000
Rain_barrel3	19,18	0,000	0,000	0,000	9,177	0,000	0,000	9,392
Infiltration_trench3	0,000	19,83	0,000	19,83	0,000	0,000	0,000	0,000
Infiltration_trench2	0,000	19,83	0,000	19,83	0,000	0,000	0,000	0,000
Green_roof1	0,000	19,83	0,000	0,000	0,000	0,000	0,000	19,83
Green_roof2	0,000	19,83	0,000	0,000	0,000	0,000	0,000	19,83
<b>Total</b>	<b>264,6</b>	<b>222,1</b>	<b>0,000</b>	<b>209,7</b>	<b>29,60</b>	<b>26,42</b>	<b>0,000</b>	<b>146,8</b>

Figure 4.48 Example of a LID simulation summary





## 5 Modelling Stormwater Quality (SWQ)

### 5.1 Introduction

#### SWQ - A model associated with urban catchments and rainfall-runoff modelling

The importance of wide-ranging and yet efficient modelling of stormwater quality on urban catchments and the transport of polluted stormwater in the urban drainage networks is growing with increased focus on local handling of stormwater, drainage network separation, stormwater treatment prior to release to recipients, as well as untreated stormwater overflows.

Stormwater pollution associated with urban catchment surfaces includes dissolved matter and suspended particles originating from:

- Soil erosion
- Erosion of construction materials (roofs, roads)
- Air borne pollution (e.g. industrial emissions particles)
- Local biological pollution related to humans and wildlife (various waste, birds droppings)
- Traffic debris
- Etc.

MIKE+ SWQ simulates stormwater quality as a special model associated with urban catchments and stormwater runoff and infiltration. This is illustrated in Figure 5.1.

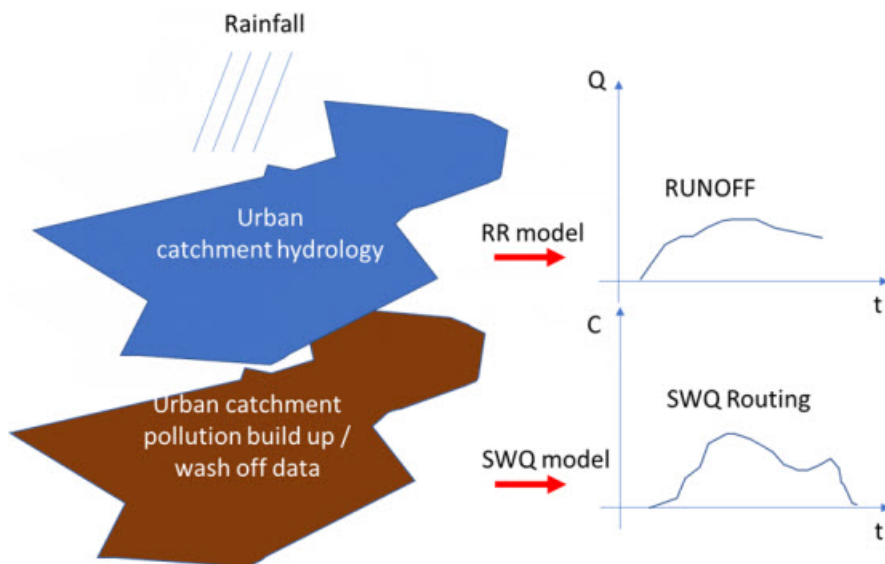

Figure 5.1 Rainfall-runoff and SWQ models act simultaneously on an urban catchment. Both models are driven by the rainfall and by the model parameters controlling the quantities and dynamics of runoff and surface pollution, respectively, being routed towards the catchment outlet.

## Spatial and temporal variation of pollution in urban catchments

### Model catchments vs. spatial distribution of surface pollution

The amount of surface pollution on urban catchments varies both in space and time, governed by types of pollutants, types of catchment surface and its uses. This variation needs to be captured as correctly as possible in the simulation model in order to achieve realistic model results.

The urban drainage model area is typically delineated into a number of sub-catchments, with delineation determined by the drainage network layout, topography or even administrative limits (parcels, urban districts, etc.).

Sometimes, the sub-catchment delineation is done by a simple division (e.g. Thiessen polygons), i.e. is based on purely geometrical reasoning. Only in rare cases, such delineations are appropriate for efficient characterisation of surface pollution loads generated on such sub-catchments.

Therefore, model sub-catchments would typically include different surfaces, such as building roofs made of different material, roads with various traffic intensity and with different paving, green areas with different vegetation, etc.).

Each of these surfaces may have different usage as well. This means that a single model catchment may be a source of various pollutants, differing by:



- Pollutant type:
  - Organic pollution
  - Chemicals
  - Microplastic
  - Heavy metals
  - Etc.
- Pollutant origin and build-up/wash-off mechanism:
  - Airborne (wind, smog)
  - Area use (traffic, people, animals, local industry)
  - Erosion of surface materials (metal roofs, asbestos, PAH...)
  - Soil erosion
- Attachment to surface sediments:
  - Particulate suspended, attached to surface sediments
  - Particulate suspended, on its own
  - Dissolved

These differences get manifested in various pollutants' quantities and their different behaviour on the catchment surface in dry weather (build-up) and when exposed to rainfall (wash-off). The following simple examples illustrates a typical situation.

A catchment has a total area of 2.1 ha. From the point of view of surface pollution, three types of surfaces may be distinguished: building roofs (15% or 0.315 ha), roads (10% or 0.21 ha) and the remaining 75% (or 1.575 ha) is green area. Each of these surfaces may be a source of various pollutants by itself and is exposed to build-up of exogenous pollution by different intensity and dynamics, depending on the surface exposure to external impacts. Further, these pollutants may behave differently in terms of wash-off by action of rainfall.

A MIKE+ model may contain many - often thousands - of such catchments.

### Decomposing catchments to pollution-related layers

In order to capture such situation correctly and efficiently in the model, the catchment (i.e. each sub-catchment in the model) is decomposed to a number of stacked, geographically identical catchments. In the described case, the catchment is represented by three layers, each one representing one of the three surface types. This is illustrated in the following figure:

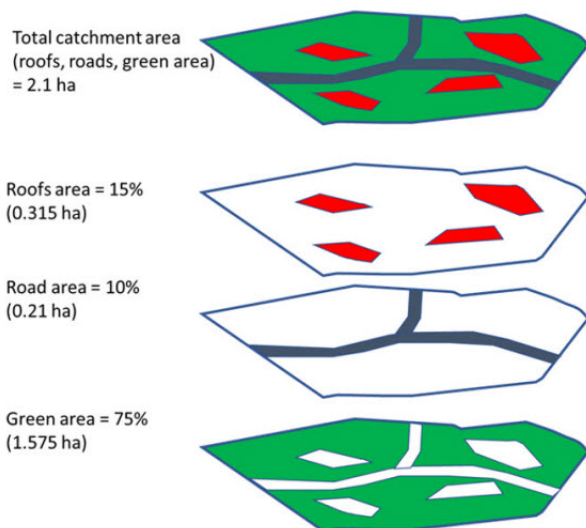

Figure 5.2 A catchment decomposed to three layers, each representing one type of catchment surface.

The upper-most polygon represents the actual catchment. In the model, this catchment is represented by the three polygons below, representing roofs, roads and green areas, respectively.

These three model catchments may inherit the hydrological parameters and connections to the network, but these can also be modified to facilitate a better description of behaviour of the various surface types in the actual catchment.

In any case, the layered catchments will differ by the actual drainage area, which corresponds to the actual area of respective type of surface in the given physical catchment. The sum of the contributing areas for the three sub-catchments must equal to the actual contributing area for the catchment.

### Modelling SWQ from multiple surface types as special type of boundary conditions

Surface pollution loads are defined as special types of boundary conditions to the catchments model (SWQ boundary conditions), similarly as rainfall is specified as a boundary for a precipitation-runoff model. Specifying surface pollution loads as boundary conditions, independent of rainfall boundary conditions, is necessary because spatial distributions of rainfall and of surface pollution are fully independent. Treating rainfall and surface pollution through independent boundary conditions implies that the rainfall and surface pollution can each be modelled with its own geographical distribution.

Since every SWQ boundary condition is associated with one definition of geographical location (i.e. reference to one or more catchments: All, List or Individual), and with any number of WQ boundary properties - one for any given pollutant component, each type of catchment surface must be



described by a separate SWQ boundary condition. I.e. as many surface types user wants to simulate, as many stacked catchment layers and SWQ boundary conditions shall be specified.

Each of these boundary conditions shall be connected to a sub-set of catchments representing certain type of surface and would include as many WQ boundary properties as there are pollutant components associated with that type of surface - each with its own quantities (i.e. temporal variation) method.

## 5.2 SWQ Model Setup

SWQ model setup includes the following components:

- Urban catchments with hydrological parameters for the applied precipitation-runoff model
- Rainfall boundary condition (any type of uniform or spatially distributed rain (dfs0 or dfs2))
- WQ component(s) and/or ST fraction(s)
- SWQ Global data
- SWQ local parameters (applies for Build-up/wash-off and EMC methods only)
- SWQ boundary conditions (Surface and/or RDI): multiple boundary conditions are specified in case when spatial differentiation of SWQ loads is analyzed, e.g. case of different catchment surface types or land uses
- SWQ Boundary properties: for each SWQ boundary condition properties have to be defined for each pollutant component and/or sediment fractions.
- SWQ Output definition
- Simulation setup

In the following sections, SWQ-specific model setup is presented in full detail.

Finally, the workflow sequence is briefly described in Section 5.7.

General issues (urban catchments, rainfall boundary conditions, WQ components, ST fractions, Output definition and Simulation setup) are described elsewhere in the MIKE+ Collection System User Guide.

## 5.3 SWQ Global Data

Model parameters included in SWQ Global data (see Figure 5.3) apply for entire model and for SWQ advanced methods only.



Figure 5.3 SWQ Global Data Editor

An overview of SWQ Global Data editor attributes is provided in Table 5.1.

Table 5.1 Overview of the SWQ Global Data editor attributes (Table msm\_SWQGlobalData)

Edit Field	Description	Usage	Attribute Table Field
Initial ADWP	Duration of antecedent dry weather period before the start of the simulation [hours]	Build-up /Wash-off and EMC methods	ADWPIni
Event threshold	Peak rainfall intensity in a rainfall event, used as a minimum threshold to include the rainfall event in the SQW computation	EMC method	EventThreshold
Min ADWP	Any two rain intervals separated by a dry interval are considered as the continuous rain event if the dry interval between the two wet-weather periods is less than the specified ADWPmin	EMC method	ADWPMin

## 5.4 SWQ Methods

Similarly as hydrological processes and runoff from urban catchments can be simulated by various runoff models, SWQ supports several methods for simulating processes related to stormwater quality. The available methods are:



1. Simple concentration
2. Table concentration
3. Build-up/Wash-off
4. Event mean concentration (EMC)

**Method 1** (Simple concentration) applies a pollutant concentration directly to the runoff from a catchment. The applied concentration can be specified as constant or based on an arbitrary time series.

**Method 2** (Table concentration) applies a tabulated concentration of pollutant specified as a tabulated function, based on the runoff intensity (i.e. specific runoff).

Note that Method 1 and Method 2 do not consider availability of pollutants. In other words, these methods assume unlimited supply of pollutants on the catchment surface. As such, they should be applied with care and only in appropriate cases.

**Method 3.** (Build-up/Wash-off) simulates the build-up of pollutants or sediments on the catchment surface and wash-off of this pollution by mechanical action of rainfall events. This method is mass-conservative, i.e. the amount of pollutant washed-off from the catchment surface is limited by the build-up process. This method is appropriate for simulating first flush.

**Method 4.** (EMC) assumes that the concentration of pollutant in runoff is constant throughout rainfall event. The method simulates the build-up of pollutants or sediments on the catchment surface in the same way as Method 3, but the rain-dependent wash-off process is replaced by a calculated event-mean concentration. This method is mass-conservative, i.e. EMC or amount of pollutant washed-off from the catchment surface is limited by the build-up process.

Both Method 3 and Method 4 are appropriate for simulating multiple, consecutive rainfalls, e.g. in connection with LTS. These methods are also referenced as SWQ advanced methods.

## SWQ Advanced Methods

SWQ advanced methods include Build-up/Wash-off and Event-mean Concentration (EMC) methods.

In addition to SWQ global data, computations in these methods are driven by user-specified sets of parameters (SWQ local data), which may be associated with each SWQ boundary property separately. This means that different behaviour of each pollutant and each catchment surface type, in terms of pollutant quantities and build-up/wash-off mechanisms, can be simulated.

Parameter set for modelling SWQ using advanced methods are specified through the SWQ Advanced Methods Editor (Figure 5.4).

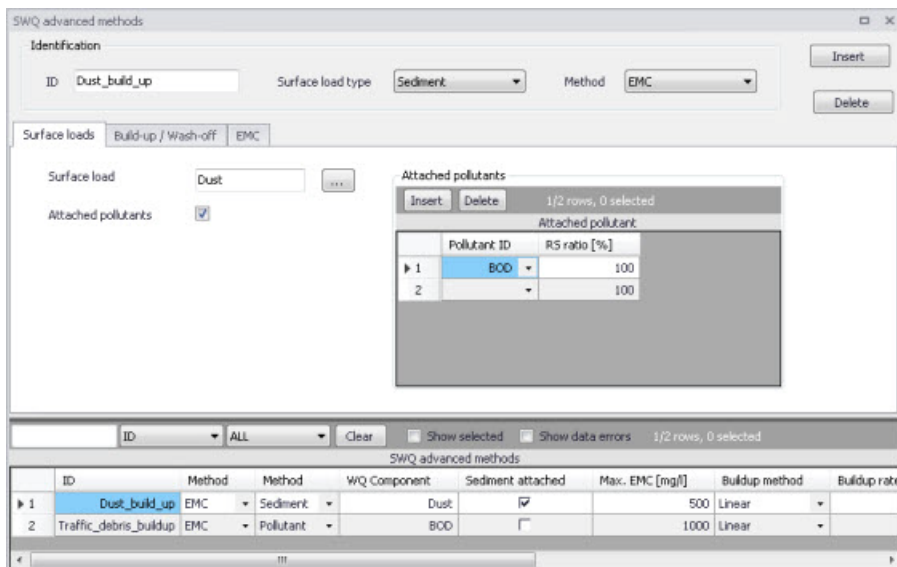

Figure 5.4 The SWQ Advanced Methods Editor

The different parts tabs of the editor are described in succeeding sections below.

### 5.4.1 Identification

The main properties of the SWQ parameter set are defined in the Identification box. Any SWQ parameter set may refer either to a pollutant component or to a sediment fraction (with or without pollutants attached). Also, the set will apply for one of the two SWQ advanced methods only (Build-up/Wash-off or EMC).

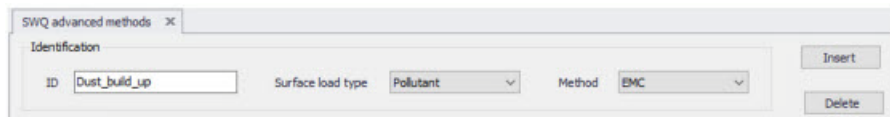

Figure 5.5 Identification box in the SWQ Advanced Methods Editor

An overview of database attributes and their usage is found in Table 5.2 below.





Table 5.2 SWQ Advanced Methods Identification box attributes (Table msm\_SWQPollutant)

Edit Field	Description	Usage	Attribute Table Field
ID	Unique name (identifier) for SWQ local parameter set	Build-up/Wash-off and EMC methods	MUID
Surface load type	1 = Pollutant component 2 = Sediment fraction	Build-up/Wash-off and EMC methods	TypeNo
Method	Choice of SWQ computation method 1 = EMC 2 = Build-Up/Wash-Off	Build-up/Wash-off and EMC methods	MethodNo

### 5.4.2 Surface Loads

The Surface Loads tab (see Figure 5.6) specifies the pollutant component (or sediment fraction) associated with actual SWQ parameter set.

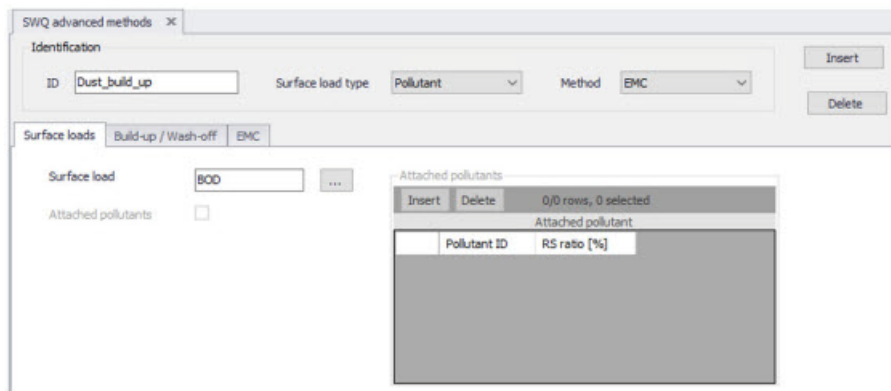

Figure 5.6 Surface Loads Tab in the SWQ Advanced Methods Editor

A description of attributes in the Surface loads tab and their usage is found in Table 5.3 below.



Table 5.3 SWQ Advanced Methods editor Surface Loads tab attributes (Table msm\_SWQPollutant)

Edit Field	Description	Usage	Attribute Table Field
Surface Load	Choice of pollutant component (or sediment fraction)	Build-up/Wash-off and EMC methods	ComponentID
Attached pollutants	0 = No pollutants attached (default) 1 = Pollutants attached to sediments	Build-up/Wash-off and EMC methods, TypeNo = 2 (sediment fraction)	SedimentAttachNo

If the actual parameter set relates to a sediment fraction, pollutants may (optionally) be attached to the sediments through inputs in the editor's secondary grid (database table msm\_SWQAttachedPollutant (see Figure 5.7).

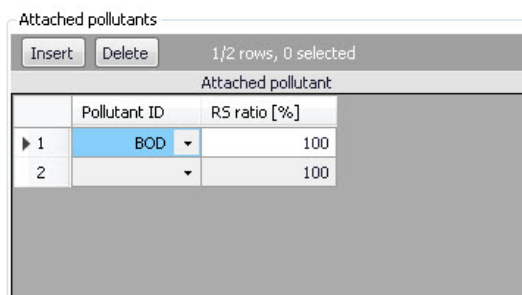

Figure 5.7 The Attached Pollutants secondary grid in the Surface Loads Tab

The amount of the sediment-attached pollutants is specified as a fraction (percentage) of the sediment mass. The total of the attached pollutants shall not exceed 100%.

When surface load is specified as a pollutant component, the model output is directed into the SWQ pollutants output, which may be used as input into the network advection-dispersion simulation (directly in case of simultaneous catchment and network simulation, or as a WQ boundary property to the run-off load into the network model).

When surface load is specified as a sediment fraction, the model output is directed into the SWQ sediments output, which may be used as input into the network sediment transport simulation (directly in case of simultaneous



catchment and network simulation, or as an ST boundary property to the run-off load into the network model).

Attached pollutants (if any) are directed into the SWQ pollutants output, similarly as in case of a pollutant surface load. The mass of pollutants is calculated as a specified fraction of sediment mass.

A description of attributes in the Attached Pollutants secondary grid (table msm\_SWQAttachedPollutant) and their usage is found in Table 5.4 below.

Table 5.4 Overview of the Attached Pollutants secondary grid attributes (Table msm\_SWQAttachedPollutant)

Edit Field	Description	Usage	Attribute Table Field
PollutantID	Duration of antecedent dry weather period before the start of the simulation [hours]	Build-up/Wash-off and EMC methods, SedimentAttachNo =1	PollutantID
RSRatio	Peak rainfall intensity in a rainfall event, used as a minimum threshold to include the rainfall event in the SQW computation	Build-up/Wash-off and EMC methods, SedimentAttachNo =1	PSRatio

### 5.4.3 Build-Up/Wash-Off

The Build-up/Wash-off tab (see Figure 5.9) provides the local parameters for the Build-up/Wash-off method.

Build-up parameters are:

**Method:** Linear or Exponential. During dry weather periods pollution or sediments accumulate on the surface of urban catchments. The most common formulations for this process are to assume that the build-up is a linear or an exponential function of time. The choice between the two formulations is not straightforward due to insufficient experimental results.

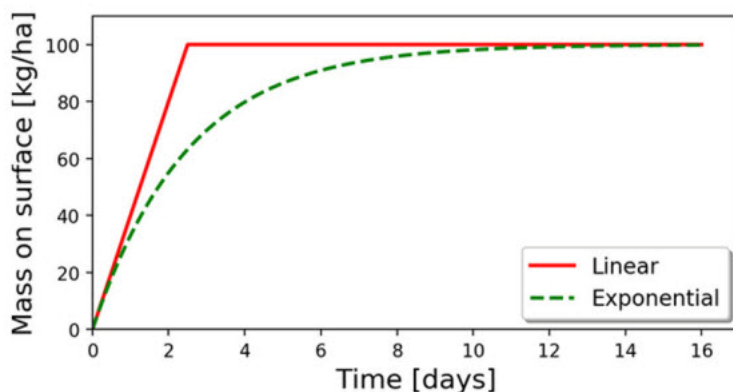

Figure 5.8 Illustration of the linear and the exponential build-up function. For details of mathematical formulation, see MIKE 1D Reference Manual.

**Rate:** Linear build-up rate of the pollutant component (or sediment fraction) on the catchment surface, given as mass per unit area per unit of time.

**Max:** Maximum possible amount of pollution (or sediment) on the catchment surface. This represents an equilibrium situation, when removal rate is equal to build-up rate.

Section	Parameter	Value	Unit
Pollutant Build-up	Rate	2	[kg/ha/d]
	Max.	20	[kg/ha]
	Method	Linear	
Wash-off	Detachment rate	500	[kg/ha/d]
	Exponent	2	

Figure 5.9 The Build-Up/Wash-Off Tab in the SWQ Advanced Methods Editor

Wash-off parameters are related to the applied wash-off formula, which is based on the assumption that the wash-off is exponentially related to the rain intensity.

**Detachment rate:** Wash-off (detachment) rate at rainfall intensity 25.4 mm/hour (1 inch/hour). This is a calibration factor for the wash-off process: smaller values apply for pollutants firmly attached the catchment surface, higher values apply for loose particles.

Note that the "Detachment rate" operates with sediment mass uniformly spread over entire contributing catchment area. The default value of 10000 kg/ha/day, assuming the sediment density of 2650 kg/m<sup>3</sup> and zero porosity, is equivalent to the velocity of rain penetration into the sediment layer of 16 mm/h. The recommended values are up to max. 30 mm/h.



**Exponent:** Default value is 2, which implies that the wash-off is proportional to the kinetic energy of the rain drops.

A description of attributes in the Build-up/Wash-off tab and their usage is found in Table 5.5 below.

Table 5.5 Overview of the SWQ Advanced Methods Build-up/Wash-off tab attributes (Table msm\_SWQPollutant)

Edit Field	Description	Usage	Attribute Table Field
Pollutant Build-Up/Rate	Linear build-up rate of pollutant (sediment) on the catchment surface ( $ML^{-2}T^{-1}$ )	Build-up /Wash-off and EMC methods	BuildUpRate
Pollutant Build-Up/Max.	Maximum amount of pollutant (sediment) on the catchment surface per unit area ( $ML^{-2}$ )	Build-up /Wash-off and EMC methods	MaxBuildUp
Pollutant Build-Up/Method	1 = Linear 2 = Exponential	Build-up /Wash-off and EMC methods	BuildUpTypeNo
Wash-Off/Detachment Rate	Pollutant (sediment) detachment rate at rainfall intensity 25.4 mm/hour (1 inch/ hour)	Build-up /Wash-off method	DetachRate
Wash-Off/Exponent	Default value is 2. Larger values increase the wash off non-linear dependency on the rainfall intensity. Value 1 implies a linear dependency	Build-up /Wash-off method	WashOffExp

#### 5.4.4 EMC

The EMC tab (see Figure 5.10) provides a single local parameter for the EMC (Event Mean Concentration) method.



Surface loads | Build-up / Wash-off | EMC | [ ]

Max. EMC [ 500 ] [mg/l]

Figure 5.10 The EMC Tab in the SWQ Advanced Methods Editor

**Max. EMC:** Is the maximum possible concentration of the pollutant component (or sediment fraction) in the runoff leaving the catchment.

The primary role of this parameter is to prevent unrealistic results i.e. very high values of pollutant EMC in case of long ADWP and/or high build-up rates during small rain events. In such cases, Max. EMC will prevent the full removal of pollutants by a small rain.

Table 5.6 Overview of the SWQ Advanced Methods EMC tab attributes (Table msm\_SWQPollutant)

Edit Field	Description	Usage	Attribute Table Field
Max. EMC	Maximum event mean concentration; used to prevent unrealistically high concentrations and full wash-off by a minor rainfall	EMC method	MaxEMC

## 5.5 Boundary Conditions for SWQ

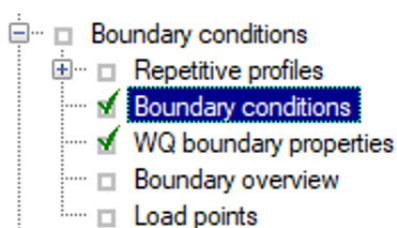

SWQ boundary conditions define domain of validity for the actual boundary condition (surface runoff or RDII) and the boundary condition spatial extent.

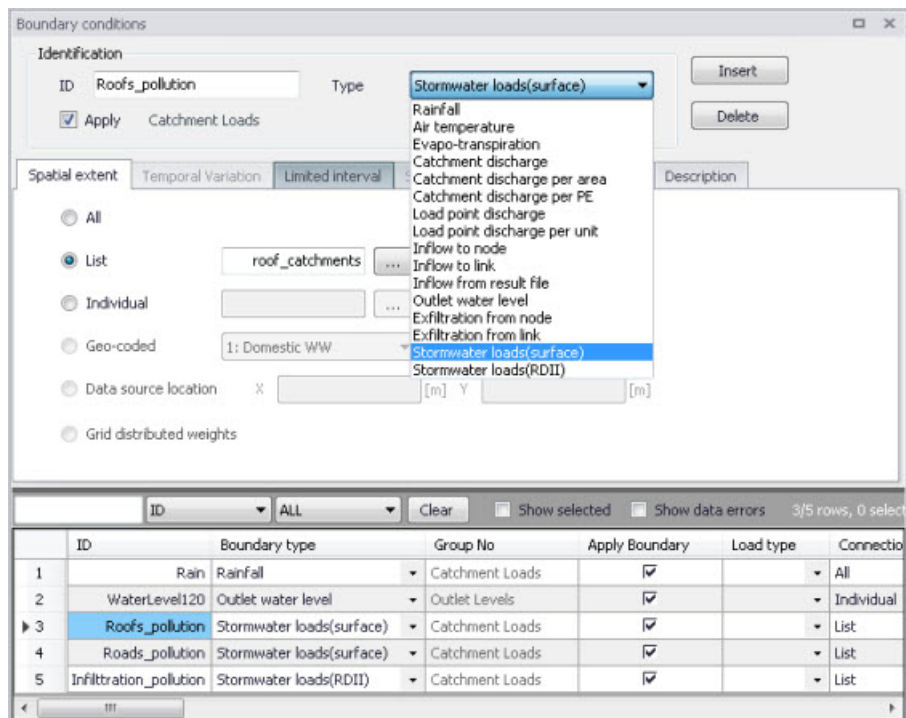

Figure 5.11 The Boundary Conditions Editor showing Types relevant for SWQ

### 5.5.1 SWQ Boundary Condition Types

SWQ boundary conditions are of the following types (see Figure 5.11):

- Stormwater Loads (Surface). This type applies for WQ in surface runoff.
- Stormwater Loads (RDII). This type applies for WQ in RDII flows.

Table 5.7 provides an overview of the SWQ methods that are applicable under the two types of stormwater loads (surface runoff and RDII), i.e. with the two types of SWQ boundary conditions.



Table 5.7 Overview of applicable SWQ boundary condition types and SWQ methods for various hydrological models and their combinations. All surface runoff models support all four SWQ methods, while RDI supports only Method 1 (Simple Concentration) and Method 2 (Tabulated concentration).

Hydrological model/combination	SWQ Boundary condition and SWQ methods	
	Stormwater loads (surface)	Stormwater loads (RDI)
Time-Area	Methods 1, 2, 3, 4	-
Time-Area + RDI	Methods 1, 2, 3, 4	-
Kinematic Wave	Methods 1, 2, 3, 4	-
Kinematic Wave + RDI	Methods 1, 2, 3, 4	Methods 1,2
Linear Reservoir (C1)	Methods 1, 2, 3, 4	-
Linear Reservoir (C1) + RDI	Methods 1, 2, 3, 4	Methods 1,2
Linear Reservoir (C2)	Methods 1, 2, 3, 4	-
Linear Reservoir (C2) + RDI	Methods 1, 2, 3, 4	Methods 1,2
UHM	Methods 1, 2, 3, 4	-
UHM + RDI	Methods 1, 2, 3, 4	Methods 1,2
RDI (solo)	-	Methods 1,2

### 5.5.2 Spatial Extent

As any other boundary condition, SWQ Boundary Conditions may be specified as uniform for the entire model (i.e. associated with all model catchments), or as spatially distributed through selections of catchments and/or individual catchments.

Figure 5.12 illustrates definition of spatial extent based on a list (selection). Note that selections may refer to different geographical areas as well as to different catchments layers.

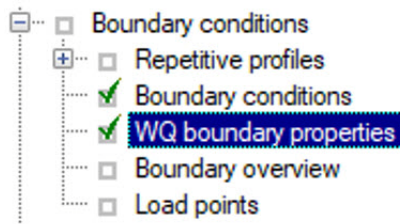



Figure 5.12 Example of a Stormwater Loads (Surface) boundary condition with spatial extent defined by a list (selection) of catchments (roof\_catchments)

## 5.6 WQ Boundary Properties for SWQ

SWQ quantities and computation methods for various pollutants associated with an SWQ Boundary Condition are specified in the WQ Boundary Properties Editor.





WQ boundary properties

Boundary condition selector:  
Roofs\_pollution ...

Spatial extent: Listroof\_catchments  
Temporal variation: Constant, Value:  
Description:

Identification

ID: Dust\_on\_roofs Type: Pollutant concentration

Insert  
Delete

Water quality | Temporal Variation | Scaling factor | Description

WQ component: BOD ...  
Sediment fraction: ...

Type: Pollutant  
Decay constant: 0  
Initial condition: 0

ID	WQBoundary type	Trap component ID	Trap fraction ID	Variation No
1	Dust_on_roofs	Pollutant concentration	BOD	Constant
2	T_runoff	Temperature	T	Constant

Figure 5.13 The WQ Boundary Properties Editor with an example SWQ boundary water quality item (i.e. Roofs pollution with dust)

Normally, one SWQ boundary property should be specified for each pollutant included in an SWQ boundary condition.

Definition of WQ boundary properties follows the same workflow as any other WQ boundary property. For details, see descriptions under the Boundary Conditions Chapter in the manual.

In addition, WQ boundary properties for SWQ include two special types of Temporal variations:

- Table concentration (supports application of SWQ table concentration method)
- SWQ advanced (supports application of SWQ advanced methods: Build-up/Wash-off and EMC).

Definition of WQ boundary properties in the WQ Boundary Properties Editor for all SWQ methods is described in the following sections.



### 5.6.1 Boundary Condition Selector

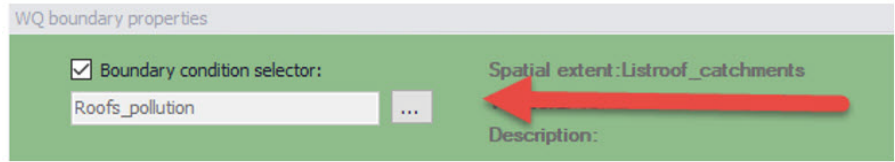

Figure 5.14 The Boundary Condition Selector is the step in specifying WQ boundary properties for SWQ

The wanted SWQ boundary condition item to be associated with a water quality boundary property is selected in the Boundary Condition Selector on top of WQ Boundary Properties editor.

### 5.6.2 Identification

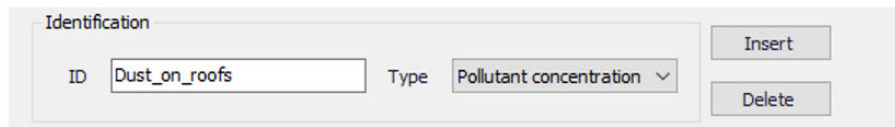

Figure 5.15 Identification information for the WQ boundary property for SWQ

After inserting a new WQ boundary property, it shall be given a proper name (identifier) and a correct (water quality) type shall be selected.

For easier identification, the property name should reflect its contents, i.e. which pollutant (or sediment) and which model area it describes.

Type is selected among available choices filtered according to currently specified WQ components.



### 5.6.3 Water Quality

Water quality | Temporal Variation | Scaling factor | Description

WQ component: BOD

Sediment fraction:

Type: Pollutant

Decay constant: 0

Initial condition: 0

Figure 5.16 The Water Quality Tab in the WQ Boundary Properties Editor. Used to define pollutant component (or sediment fraction) associated with the current WQ boundary property.

Depending on the specified (water quality) type, the user selects the relevant WQ component or sediment fraction.

### 5.6.4 Temporal Variation

Water quality | Temporal Variation | Scaling factor | Description

Constant: Value: 100 [mg/l]

Cyclic: Value: [mg/l], Pattern: [mg/l]

Time series: File name: TS\_Diffconc\_conc.dfb, Time series ID: Zinc\_conc, Data type: Concentration

Table concentration: Table ID: Zinc\_concentrations

SWQ Advanced: SWQ ID: Dust\_build\_up

Figure 5.17 The Temporal Variation Tab in the WQ Boundary Properties Editor

In the context of SWQ, definition of temporal variation for WQ boundary property is closely connected to the choice of SWQ method, as summarized in the overview in Table 5.8.



Table 5.8 Overview of relation between Temporal Variation and SWQ Methods

Temporal Variation	SWQ Method			
	Method 1 (Simple concentration)	Method 2 (Table concentration)	Method 3 (Build-up/ Wash-off)	Method 4 (EMC)
Constant	Yes	-	-	-
Cyclic	-	-	-	-
Time series	Yes	-	-	-
Table concentration	-	Yes	-	-
SWQ advanced	-	-	Yes	Yes

### Method 1: Simple Concentration (Constant)

The screenshot shows a software interface with several tabs: 'Water quality', 'Temporal Variation', 'Scaling factor', and 'Description'. The 'Temporal Variation' tab is selected. Under this tab, there are three radio button options: 'Constant', 'Cyclic', and 'Time series'. The 'Constant' option is selected, and a red arrow points to it. Below the 'Constant' option, there are input fields for 'Value' (set to 100 [mg/l]), 'From' (empty), and 'Time' (empty). There is also a checkbox for 'Gradual start up' which is unchecked. The 'Cyclic' and 'Time series' options have their own respective input fields for 'Value', 'Pattern', 'File name', 'Time series ID', and 'Data type'.

Figure 5.18 Definition of constant SWQ concentration

A constant value of any WQ component (e.g. concentration, temperature, etc.) is assigned to runoff.



## Method 1: Simple Concentration (Time series)

The screenshot shows a software interface with four tabs: 'Water quality', 'Temporal Variation', 'Scaling factor', and 'Description'. Under 'Temporal Variation', three radio buttons are present: 'Constant', 'Cyclic', and 'Time series'. The 'Time series' option is selected and highlighted with a red arrow. Below these are three panels. The first panel (Constant) has a 'Value' field set to '100 [mg/l]', a 'Gradual start up' checkbox, and 'From' and 'Time' fields. The second panel (Cyclic) has a 'Value' field, a 'Pattern' field, and a dropdown menu. The third panel (Time series) has a 'File name' field with 'TS\_DB\zinc\_conc.dfs0', a 'Time series ID' field with 'Zinc\_conc', and a 'Data type' field with 'Concentration'.

Figure 5.19 Time series of values of any property is assigned to runoff. In absence of measured data, time series typically reflect an estimate of seasonal variations.

Application of time series values for SWQ boundary properties implies knowledge or estimates of historical variations of any WQ component, e.g. in the context of a WQ model calibration.

## Method 2: Table Concentration

The screenshot shows the same software interface as Figure 5.19. In this case, the 'Table concentration' radio button is selected and highlighted with a red arrow. The 'Table ID' field in the 'Table concentration' panel contains 'Zinc\_concentrations'.

Figure 5.20 Table Concentration applies to the SWQ Table Concentration method

A tabular function of the type Runoff pollutants is selected and associated with the WQ boundary property. It establishes a fixed relation between the runoff intensity (specific runoff) and the value of WQ component, e.g. pollutant concentration.

## Methods 3 (Build-up/Wash-off) and 4 (EMC): Advanced Methods

The screenshot shows the same software interface. The 'SWQ Advanced' radio button is selected and highlighted with a red arrow. The 'SWQ ID' field in the 'SWQ Advanced' panel contains 'Dust\_build\_up'.

Figure 5.21 SWQ Advanced is chosen when SWQ Method 3 (Build-up/Wash-off) or Method 4 (Event Mean Concentration) is applied



After selecting SWQ advanced, the user must choose one among previously specified SWQ parameter sets for the pollutant or sediment fraction associated with the current WQ boundary property.

The SWQ parameter sets are related to one of the two SWQ advanced methods and contain a definition of the parameters for the chosen method. The actual parameters can be looked up in the SWQ Advanced Methods editor.

## 5.7 Workflow

Modelling of SWQ is summarised through description of a workflow.

At the outset, it is assumed that a functional MIKE+ model including one or more catchments is available.

### Prepare layered catchments (optional)

If the analysis includes various types of surfaces, and if the catchments delineation does not reflect the surface types, the original sub-catchments shall be cloned into layers. All layers of catchments shall be connected to the network identically. Drainage area for all catchments representing one physical catchment shall be specified. The sum of the drainage area for a catchment must be equal to the full contributing catchment area.

### Specify rainfall boundary

A rainfall boundary condition series shall be specified. A single rainfall time series may be associated with all catchments in the model, or the rainfall can be spatially distributed by specifying multiple rain gauges or RADAR rainfall data.

### Specify WQ components and sediment fractions

To be included in SWQ computation, any WQ component and/or sediment fraction must be defined in respective editors (WQ Components editor or Sediment Fractions editor, respectively).

### Activate SWQ module

To enable the Stormwater Runoff WQ (SWQ) module, activate the Catchment feature, and the Rainfall-Runoff (RR) and Transport (AD, SWQ) modules (in the 'General Settings | Model type' editor). This will provide access to all relevant editors.

### Consider appropriate SWQ method

As shown in Table 5.7, the applicability of the SWQ methods depends on the runoff component, i.e. choice of the runoff model.

Also, not all of the available SWQ methods are applicable to all types of pollutants/sediments. E.g. external pollutants are best simulated by mass-conservative methods (i.e. Methods 3 and 4).



### Review Global SWQ parameters

If one of the advanced SWQ methods is to be applied, review and adjust SWQ global parameters (in the SWQ Global Data editor).

### Specify SWQ parameters sets

If one of the advanced SWQ methods is to be applied in the SWQ computation for any of the pollutants or sediment fractions, SWQ parameter sets must be specified for such pollutants or sediment fractions.

Note that several parameter sets may be specified for any pollutant or sediment fraction - each for one type of catchment surface.

### Specify SWQ boundary conditions

For each type of catchment surface and for each runoff component, a separate boundary condition can be specified as one of the two available SWQ boundary types. Association of the boundary condition with model sub-catchments representing a specific type of surface is achieved by specifying appropriate selection list.

### Specify SWQ boundary WQ properties

For each of the specified SWQ boundary conditions, a number of WQ properties can be specified. Normally, one WQ property is defined for each pollutant (or sediment fraction) assumed to be present on the actual catchment surface type and in the actual runoff component. For details, refer to Section 5.6..

### Set up a runoff simulation with SWQ

The SWQ setup is included in the runoff simulation simply by ticking the Storm Water Quality (SWQ) checkbox in the General tab of the Simulation Setup editor.



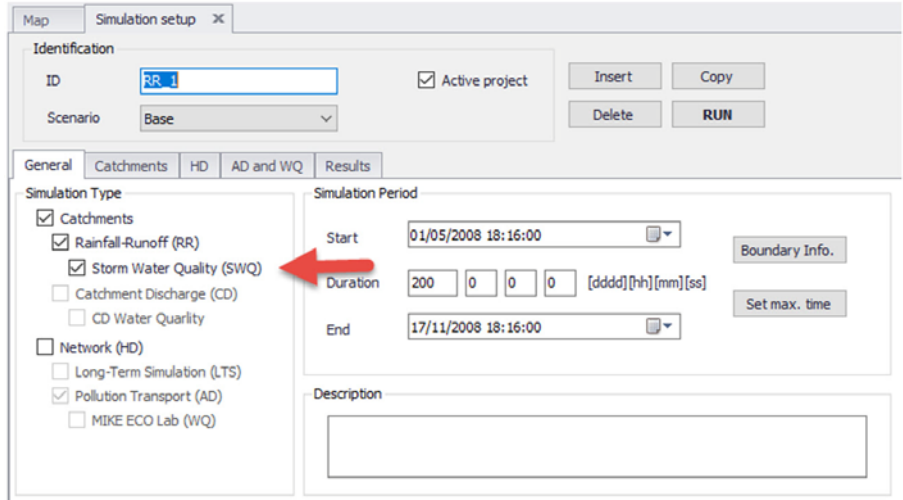

Figure 5.22 Example simulation setup for a model including Rainfall-Runoff and SWQ. Note that SWQ can only run in association with a Rainfall-Runoff simulation.

MIKE+ will automatically include relevant output files. The Default output files can be replaced or complemented by user-specified output files.

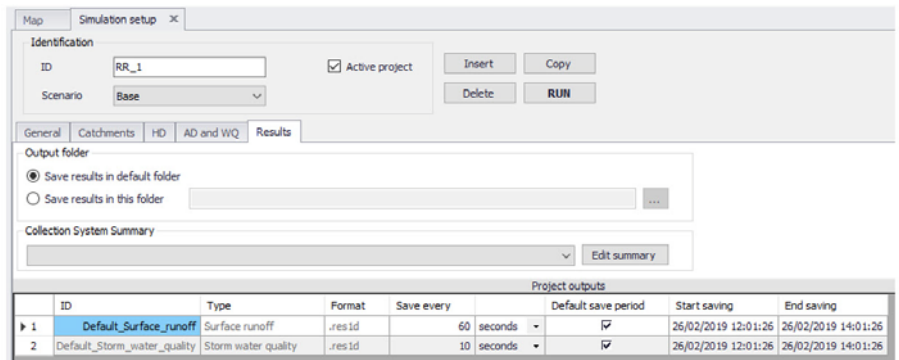

Figure 5.23 Default output is automatically provided by the system





## 6 Initial Conditions

Initial conditions are needed by most numerical models to define the initial state of hydrodynamic, water quality, and other module specific variables at the start of the simulation.

### 6.1 HD Initial Conditions

Define hydrodynamic initial conditions for network models (i.e. Rivers and/or Collection Systems) in the Initial Conditions editor in MIKE+ accessed under the Initial Conditions group on the setup tree (Figure 6.1).

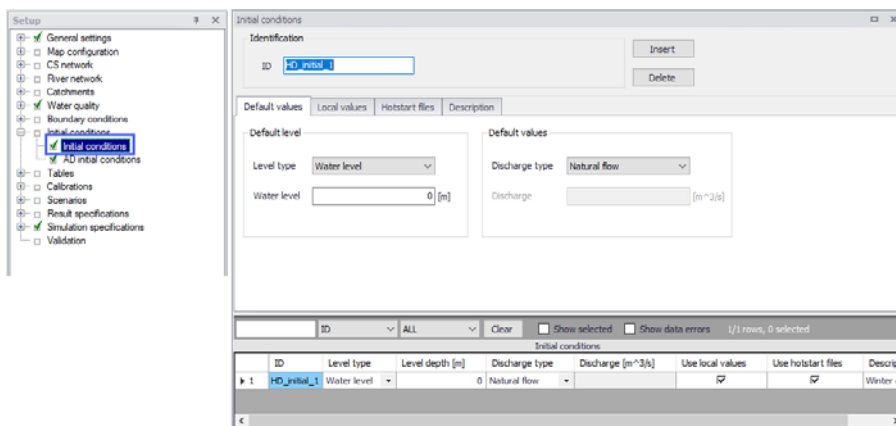

Figure 6.1 The Initial Conditions editor

Initial network HD conditions may be defined by:

- User-defined values for state variables. They may be defined as general values to be universally applied in the network models, or local values for specific parts of networks.
- Hotstart files resulting from previous simulations (i.e. previous simulation result files). Values from the hotstart file are used where available, but where computational points are not in the hotstart file, user-defined values are automatically applied.

For a set of HD initial conditions to apply in a simulation, it must be selected in this simulation definition, from the 'Simulation setup' editor.

#### 6.1.1 Identification

The Identification group contains information on the unique ID for the initial conditions setup.



Initial conditions

Identification

ID

Use the 'Insert' button to add initial conditions setups in the editor. The Delete button removes the active initial conditions setup from the list.

## 6.1.2 Default Values

Define default initial conditions in the Default Values tab page of the Initial Conditions editor (Figure 6.2).

Default values Local values Hotstart files Description

Default level

Level type

Water depth  [m]

Default discharge

Discharge type

Discharge  [m<sup>3</sup>/s]

Figure 6.2 The Default Values tab page on the Initial Conditions editor

Default values for initial conditions are applied at computational points which are not included in hotstart files, and for which no local values have been defined.

### Default Level

Initial water level conditions may be defined in terms of level or depth.

#### Level Type

How height of water at computation points is expressed. Water height may be specified as Water level (measured from a Datum) or Water depth (measured from the invert level).

#### Water Level/Depth

Corresponding value for the water level or depth.

### Default Discharge

Discharge may be specified either as User defined flow values or calculated as Natural flow.



### Discharge Type

Discharge may be specified either as ‘User defined’ flow values or calculated as ‘Natural flow’.

### Discharge

Corresponding value for ‘User defined’ Discharge Type.

The ‘Natural flow’ option calculates discharge according to the Manning formula:

$$Q = R^{2/3} \cdot A \cdot M \cdot \sqrt{I} \tag{6.1}$$

where

$R$  = Hydraulic radius

$A$  = Flow Area

$M$  = Manning number\*

$I$  = Water surface slope

\*Natural flow calculation can use Manning (M) or Manning (n) roughness formulations depending on the selected option under Default Roughness Formulation in the Bed Roughness editor.

## 6.1.3 Local Values

Initial HD conditions may be defined in specific areas of network models in MIKE+ (i.e. Rivers and/or Collection Systems). Localized initial conditions are defined in the Local Values tab page of the Initial Conditions editor (Figure 6.3).

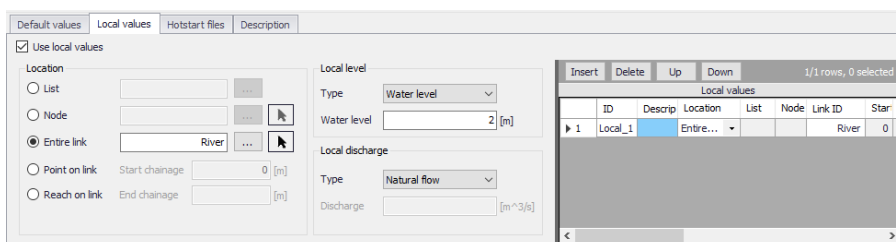

Figure 6.3 The Local Values tab page of the Initial Conditions editor

### Use Local Values

Activate the ‘Use local values’ option to allow definition of local values for the active initial conditions setup.

## Location

The location of local initial conditions may be defined by a:

- **List:** A predefined selection list of network model elements. Click on the ellipsis button to view the ID Selector dialog, which presents available selection lists. Selection lists may be defined using the Selection Manager accessed via the Map menu ribbon.
- **Node:** A particular node in the CS network. Click on the ellipsis button to view the ID selector dialog presenting a list of nodes in the project. Alternatively, use the arrow button to interactively select the node from the Main Map.
- **Entire Link:** The entire river branch or CS network link defined in the Link ID input box (see Figure 6.4). Click on the ellipsis button to view the ID selector dialog presenting a list of River branches or CS network pipes and canals that exist in the project. Alternatively, use the arrow button to interactively select the river branch or CS network link from the Main Map.
- **Point on link:** A point in the river branch or CS network link defined in the Link ID input box (Figure 6.4). Define the point along the link or river branch in the 'Start chainage' input box in the editor.
- **Reach on link:** A segment in the river branch or CS network link defined in the Link ID input box (Figure 6.4). The segment is defined by the 'Start chainage' and 'End chainage' values in the editor.

Figure 6.4 The Link ID input box for defining local initial conditions along links

## Local Level

Local initial water level conditions may be defined in terms of level or depth:

- **Type:** Water height may be specified as Water level or Water depth.
- **Water Level/Depth:** Corresponding value for the water level or depth.

## Local Discharge

Local discharge conditions may be specified as User defined flow values or calculated as Natural flow:



- **Type:** Discharge may be specified either as ‘User defined’ flow values or calculated as ‘Natural flow’. The ‘Natural flow’ option calculates discharge according to the Manning formula shown in Equation (6.1).
- **Discharge:** Corresponding value if Type is ‘User defined.’



**Note:** If two or more local values are defined within the same river reach or link, the intermediate values will be calculated by linear interpolation.

If only one local value location is defined in a river or link, then this value will be applied at the specific location and all other values in the link will be assigned Default values.

### Defining Local Initial HD Conditions

To define local initial conditions:

1. Activate the ‘Use local values’ option on the Local Values tab page.
2. Insert a row in the secondary table on the right side of the Local Values tab page using the ‘Insert’ button.

Local values						
ID	Description	Location type	List	Node	Link ID	Start
1	Local_1	Entire link			River	

3. Define the location for the local initial condition under the Location group-box.

Location

List

Node

Entire link

Point on link Start chainage 0 [m]

Reach on link End chainage [m]

4. Define initial water level/depth and discharge conditions under the Local Level and Local Discharge group boxes.



Local level

Type:

Water level:  [m]

Local discharge

Type:

Discharge:  [m<sup>3</sup>/s]

## 6.1.4 Hotstart Files

Hotstart files may be used to define HD initial conditions for networks in MIKE+. Define hotstart files to use for an initial conditions setup via the Hotstart Files tab page of the Initial Conditions editor (Figure 6.5).

ID	File
1	Hotstart_1 C:\Users\nsd\OneDrive - DHI\Documents\MIKE URBAN+ Fld

Figure 6.5 The Hotstart Files tab page in the Initial Conditions editor

The following file types may be used:

- **\*.RES1D**: MIKE 1D engine computation results.
- **\*.PRF**: MOUSE engine pipe flow computation results.
- **\*.RES11**: MIKE 11 engine computation results.

### Use Hotstart Files

Activate the 'Use hotstart files' option on the tab page to allow definition and use of hotstart files for the active initial conditions setup.

#### ID

Hotstart file ID

#### File

Hotstart file path and name.





### Use Simulation Start Time

If 'Use simulation start time' option is enabled, the initial condition is automatically extracted from the hotstart file using the simulation start date and time as specified in the 'Simulation Setup' editor.

### Date and Time

The date and time at which the initial conditions are loaded from the hotstart file. Only active if 'Use simulation start time' option is inactive.

## Defining Hotstart Files for Initial HD Conditions

1. Activate the 'Use hotstart files' option on the tab page.
2. Add a row in the secondary table on the right side of the Hotstart Files tab page using the 'Insert' button. Note that several hotstart files may be added. If a part of the network is covered by more than one hotstart file the first hotstart file will be used.

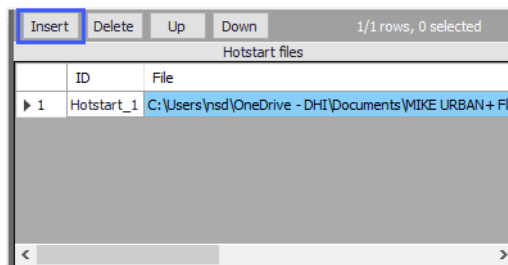

3. Define the file name and path for the hotstart file under the Hotstart File groupbox in the 'File' input box using the ellipsis button.

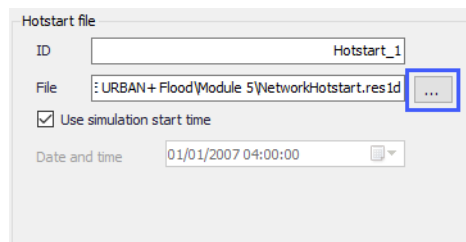

4. Define the Date and Time in the hotstart file for which initial condition values will be taken.



**Note:** It is possible to define multiple hotstart files covering different or overlapping areas. If a part of the network is covered by more than one hotstart file, the first file will be used. If a part of the network is not covered by the specified hotstart files, Default or local values are used.

If the network in a hotstart file differs from the current network e.g. the number of grid points in a link have changed, then interpolation is performed.



## 6.1.5 Description

Optional free text description for an HD Initial Conditions setup (Figure 6.6).

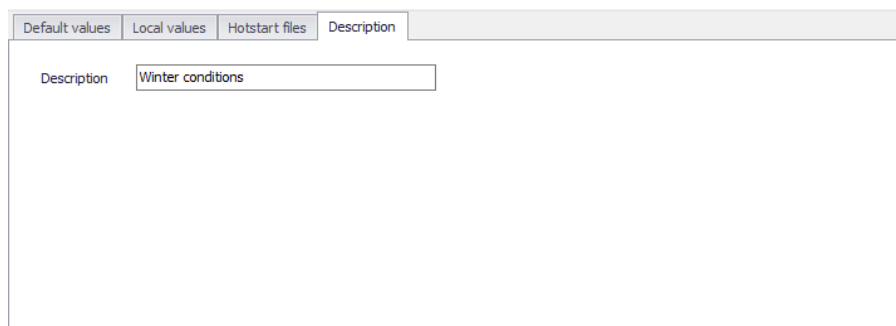

Figure 6.6 The Description tab page on the Initial Conditions editor

## 6.2 AD Initial Conditions

Initial water quality component concentrations in river and collection system networks are defined in the AD Initial Conditions editor in MIKE+ (Figure 6.7).

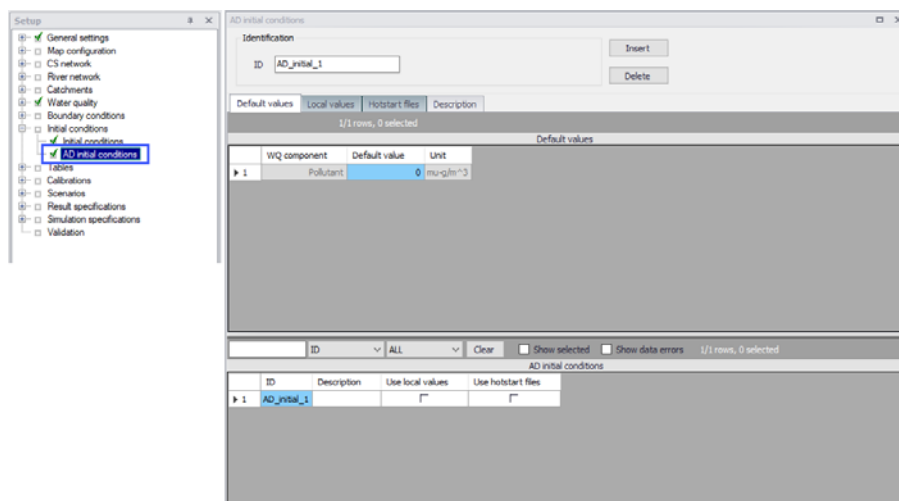

Figure 6.7 The AD Initial Conditions editor for both CS and River networks

If an initial concentration is not specified a default value of zero will be applied throughout the model. Global and local values of initial concentrations can be specified for each component.

For a set of AD initial conditions to apply in a simulation, it must be selected in this simulation definition, from the 'Simulation setup' editor.



## 6.2.1 Identification

The Identification group holds information on the unique ID for an AD initial conditions setup.

Use the 'Insert' button to add AD initial conditions setups in the editor. The Delete button removes the active AD initial conditions setup.

## 6.2.2 Default Values

Define default initial AD conditions in the Default Values tab page of the AD Initial Conditions editor (Figure 7.2).

Default values			
1/1 rows, 0 selected			
	WQ component	Default value	Unit
▶ 1	Pollutant	0	mu-g/m <sup>3</sup>

Figure 6.8 The Default Values page on the AD Initial Conditions editor

Default values for initial AD conditions are applied at computational points which are not included in hotstart files, and for which no local values have been defined.

For Water blend components, concentrations must always be given as a number between 0 and 100 %, and the sum of the two blend components must add up to 100 %.

For initial conditions specified at individual manholes, the initial conditions in connected links are calculated by linear interpolation of the concentrations specified in the upstream and downstream grid points.

## 6.2.3 Local Values

Initial AD conditions may be defined in specific areas of river and/or collection system network models. MIKE+ will use the initial values specified under the Default Values tab page except for those locations where local values have been specified.

Local initial AD conditions are defined in the Local Values tab page of the AD Initial Conditions editor (Figure 6.9).

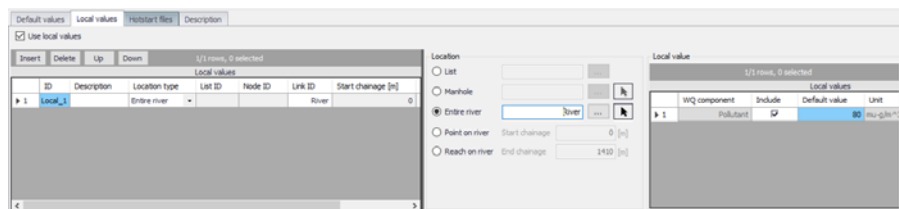

Figure 6.9 The Local Values tab page of the AD Initial Conditions editor

## Use Local Values

Activate the 'Use local values' option to allow definition of local values for the active AD initial conditions setup.

## Location

The location of local AD initial conditions may be defined by a:

- **List:** A predefined selection list of network model elements. Click on the ellipsis button to view the ID Selector dialog, which presents available selection lists. Selection lists may be defined using the Selection Manager accessed via the Map menu ribbon.
- **Node:** A particular node in the CS network. Click on the ellipsis button to view the ID selector dialog presenting a list of nodes in the project. Alternatively, use the arrow button to interactively select the node from the Main Map.
- **Entire Link:** The entire river branch or CS network link defined in the Link ID input box. Click on the ellipsis button to view the ID selector dialog presenting a list of River branches or CS network pipes and canals that exist in the project. Alternatively, use the arrow button to interactively select the river branch or CS network link from the Main Map.
- **Point on link:** A point in the river branch or CS network link defined in the Link ID input box. Define the point along the link or river branch in the 'Start chainage' input box in the editor.
- **Reach on link:** A segment in the river branch or CS network link defined in the Link ID input box. The segment is defined by the 'Start chainage' and 'End chainage' values in the editor.

## Local Value

Here the WQ component for which local initial conditions shall be set is selected. It is possible to choose between the components defined in the WQ Components editor. Local values are defined in a table containing information on:

- **WQ Component:** WQ components defined in the project in the WQ Components editor.



- **Include:** Tick this option to set local values for the corresponding WQ component for the initial AD conditions setup.
- **Default Value:** The value for the WQ component.
- **Unit:** Units for the corresponding WQ component varying according to type.



**Note:** If two or more local values are defined within the same river reach or link, the intermediate values will be calculated by linear interpolation.

If only one local value location is defined in a river or link, then this value will be applied at the specific location and all other values in the link will be assigned Default values.

## Defining Local Initial AD Conditions

To define local initial AD conditions:

1. Tick on the 'Use local values' option on the Local Values tab page.
2. Insert a row in the secondary table on the leftmost side of the Local Values tab page using the 'Insert' button.

Use local values

Insert Delete Up Down 1/1 rows, 0 selected

Local values						
ID	Description	Location type	List ID	Node ID	Link ID	Start chainage [m]
1	Local_1	Entire river			River	0

3. Define the location for the local AD initial condition under the Location groupbox.



Location

List  ...

Manhole  ...

Entire river  ...

Point on river Start chainage  [m]

Reach on river End chainage  [m]

4. Activate and define the value(s) for available WQ component(s) in the Local Value table on the rightmost side of the tab page.

Local value

1/1 rows, 0 selected

Local values				
	WQ component	Include	Default value	Unit
▶ 1	Pollutant	<input checked="" type="checkbox"/>	80	mu-g/m <sup>3</sup>

## 6.2.4 Hotstart Files

Hotstart files (\*.RES1D, \*.TRF, or \*.RES11) maybe used to define AD initial conditions for networks in MIKE+. Define hotstart files to use for an initial conditions setup via the Hotstart Files tab page of the Initial Conditions editor (Figure 7.5).

Default values Local values Hotstart files Description

Use hotstart files

Hotstart files		
	ID	File
▶ 1	Hotstart_1	C:\Users\rsd\OneDrive - DHI\Documents\DHI Work\11095105 - DSP CC S

Hotstart file

ID

File  ...

Use simulation start time

Date and time

Figure 6.10 The Hotstart Files tab page in the AD Initial Conditions editor

### Use Hotstart Files

Activate the 'Use hotstart files' option on the tab page to allow definition and use of hotstart files for the active AD initial conditions setup.



## ID

Hotstart file ID

## File

Hotstart file path and name. Files of type \*.RES1D, \*.TRF, and \*.RES11 may be used as AD hotstart files. Point to the file using the ellipsis button.

## Use Simulation Start Time

If 'Use simulation start time' option is enabled, the initial AD condition is automatically extracted from the hotstart file using the simulation start date and time as specified in the 'Simulation Setup' editor.

## Date and Time

The date and time at which the initial AD conditions are loaded from the hotstart file. Only active if 'Use simulation start time' option is inactive.

## Defining Hotstart Files for Initial AD Conditions

1. Activate the 'Use hotstart files' option on the tab page.
2. Add a row in the Hotstart files table using the 'Insert' button. Note that several hotstart files may be added. If a part of the network is covered by more than one hotstart file the first hotstart file will be used.
3. Define the file name and path for the hotstart file under the Hotstart File groupbox in the 'File' input box using the ellipsis button.
4. Define the Date and Time in the hotstart file for which initial condition values will be taken.



**Note:** It is possible to define multiple hotstart files covering different or overlapping areas. If a part of the network is covered by more than one hotstart file, the first file will be used. If a part of the network is not covered by the specified hotstart files, Default or local values are used.

### 6.2.5 Description

Add optional free text descriptions for an AD Initial Conditions setup in the Description tab page of the AD Initial Conditions editor.







## 7 Boundary Conditions

In broad terms, a model boundary condition can be defined as an external interference, which forces the behaviour of the computed variables within the model domain.

A great part of the boundary conditions represent various types of water loads (rainfall, infiltration, wastewater...). The main characteristic of these 'load' boundary conditions is that they contain a 'transport medium' - water. Water can transport other material (dissolved pollutants, oxygen, sediments), heat (temperature) and organisms (bacteria and parasites), as well as various other properties, such as pH, conductivity, turbidity, etc. Properties of 'water load' boundary conditions (expressed as concentrations, mass flow, temperature, etc.) are also, in strict terms, boundary conditions for e.g. pollution transport model (Advection-Dispersion). However, these are not treated as separate boundary conditions, but items inseparably associated with the water loads. E.g. a lateral inflow is a water load boundary condition for the hydrodynamic process in the network (defined as discharge item), while the temperature, concentration, etc. associated to this particular inflow are specified as pollutant items of that "load" boundary condition.

### 7.1 Hydraulic boundary conditions

The hydraulic boundary conditions tab allows the modeller to control the loads included and applied to the model.

In order to include a boundary in a simulation the "Apply" box must be checked.

The selected type of boundary condition controls which options are active in the different tabs. The list of available boundary condition types depends on the type of features included in the model setup (catchments, collection system network and/or river network).

#### 7.1.1 Catchment boundary conditions

Types of variables associated with catchment boundary conditions are:

- Air temperature
- Evapotranspiration
- Rainfall
- Catchment discharge
- Stormwater loads
- Groundwater abstraction
- Solar radiation



- Degree-day coefficient
- Catchment irrigation

Any number of each boundary conditions types can be specified.

**Air Temperature** is a boundary condition used for snow melt calculations and describing constant or time series varying temperature. This type of boundary is used for RDI hydrological calculations.

**Evapotranspiration** is a boundary condition describing potential evapotranspiration. This type of boundary is used for RDI hydrological calculations. The dfs0 file needs to be of the type 'Evapotranspiration'. Delete values will be considered equal to 0.0.

**Rainfall catchment** boundary condition can be defined using a constant value, a uniform time series (from .dfs0 file) or using a spatially- and time-varying file (.dfs2 file). The latter format can only be used when the spatial extent of the boundary is set to 'Grid distributed weights'. This type of boundary is used for precipitation-runoff hydrological calculations. When using a time series the dfs0- or .dfs2 file needs to use one of the following Item Types: 'Rainfall Intensity', 'Rainfall' or 'Rainfall Depth'. Delete values will be considered equal to 0.0.

**Catchment discharge** is a boundary condition of the type 'catchment load', has associated to a discharge (constant, cyclic or a time series). This type of boundary represents various kinds of hydraulic loads, such as area-based or PE-based dry weather loads, area-based infiltration, etc. The discharge can be associated with any pollutant, sediment or temperature item (constant, cyclic or a time series).

**Stormwater loads** are boundary conditions only used when the Transport module is also included in the simulation. For this boundary type, the stormwater flow value is obtained from the hydrological model and cannot be specified in the 'Boundary conditions' editor: the purpose of this boundary type is only to associate the stormwater flow to a pollutant or sediment concentrations from the 'WQ boundary properties' editor. Select the boundary type 'Stormwater loads (RDI)' for catchments modelled with the RDI hydrological model. Select the boundary type 'Stormwater loads (surface)' for catchments modelled with any of the other hydrological models. For the boundary type 'Stormwater loads (RDI)', a flow type must also be selected (Total runoff, Overland flow, Base flow, etc.), to specify to which flow component of the RDI model the pollutant or sediment concentration should be associated.

**Groundwater abstraction** is a boundary type used with the RDI hydrological model, when the 'Use abstraction' option is active in the RDI parameters and when the pumped depth is defined as varying in time. The item type defined in the selected time series must be 'Ground Water Abstraction Depth'.



**Solar radiation** is a boundary type used with the RDI hydrological model, when snowmelt modelling is included and when the 'Use solar radiation' option is active. The item type defined in the selected time series must be 'Sun radiation'.

**Degree-day coefficient** is a boundary type used with the RDI hydrological model, when snowmelt modelling is included and when the 'Degree-day coefficient type' is defined as varying in time. The item type defined in the selected time series must be 'Melting coefficient'.

**Catchment irrigation** is a boundary type used with the RDI hydrological model, when the 'Include irrigation' option is active in the RDI parameters. The item type defined in the selected time series must be 'Irrigation'.

The following chapters describes the work-flow to define a boundary condition for a catchment.

As the first action after inserting a new boundary conditions, a proper name (ID) must be specified. It is recommended to use a descriptive ID.

## 7.1.2 Network boundary conditions

In MIKE+ there is a single boundary condition editor for all types of network boundary conditions.

The following types of boundary conditions are available for collection system and/or river networks:

- **Load point discharge:** this boundary condition is linked to a load point, and the inflow is specified in the 'Load points' editor
- **Load point discharge per PE:** this boundary condition is linked to a load point, and the inflow and the number of person equivalents are specified in the 'Load points' editor
- **Inflow to node:** a discharge boundary condition applied to a node from the collection system network
- **Inflow to link:** a discharge boundary condition applied to a link from the collection system network
- **Inflow from result file:** a discharge boundary condition where the discharge time series are obtained from a result file from a previous simulation. This is usually a .res1d file from a Rainfall-runoff simulation. It can alternatively be a .dfs0 time series file, or a SWMM result file (regular .out file or outflow interface file in .txt format).
- **Outlet water level:** a water level boundary condition applied at an outlet of a collection system network. Only one water level boundary condition is allowed at each network outlet. If no boundary condition is specified for an outlet on a collection system network, a free outflow is assumed.



- Exfiltration from node: an exfiltration boundary condition applied to a node from the collection system network. . It is defined as an infiltration rate. For a manhole, the infiltration area considered during the simulation is the circular area of the manhole, and for a basin it is the surface area of the water surface, which varies in time.
- Exfiltration from link: an exfiltration boundary condition applied to a link from the collection system network, expressed as a flow per unit of length along the network.
- Open inflow to river: a discharge boundary condition applied at the end of a river
- Source inflow to river: a discharge boundary condition applied along a river. It can either be a point source applied at a point location, or a distributed source where the specified discharge is distributed evenly between a start point and an end point.
- River water level: a water level boundary condition applied at the end of a river
- River Q/h relation: the boundary condition at the end of a river is defined by a Q/h relationship, controlling the water level at the boundary as a function of the outflow.
- Free river outflow: When the free outflow type is applied, the smallest of the critical and the natural depth is applied at the boundary
- Closed river boundary: the closed boundary type is used at river end points where a zero-flux condition across the boundary is applicable.
- Inflow to storage: a discharge boundary condition applied to a storage node from the river network.
- Network rainfall: rainfall boundary conditions are specified in river reaches where the inflow of rainfall on the channel is to be represented. Rainfall can be specified globally (spatial extent = All) or as a distributed source per branch. When applied globally, the network rainfall boundary condition can be defined using a constant value, a uniform time series (from .dfs0 file) or using a spatially- and time-varying file (.dfs2 file).
- Network evaporation: evaporation boundary conditions are specified in river reaches where loss of water from evaporation from the channel is to be represented. Evaporation can be specified globally (spatial extent = All) or as a distributed source per branch. When applied globally, the network evaporation boundary condition can be defined using a constant value, a uniform time series (from .dfs0 file) or using a spatially- and time-varying file (.dfs2 file).



- **Wind friction:** wind friction on the water surface is accounted for by including wind shear stress in the simulation. When wind friction is applied, at least one wind friction boundary condition must apply to the entire network (spatial extent = All), to define a default wind field. Extra local wind boundary conditions may be added with local values and will take priority over the global wind field. When a wind friction boundary condition is included, a related 'Wind scaling factors' editor appears in the tree view, to specify local scale factors.
- **Groundwater leakage:** the groundwater leakage boundary condition represents an additional loss of water from the river to the ground-water. When the groundwater leakage boundary condition is included, a related 'Leakage coefficients' editor appears in the tree view, to specify the coefficients (global and local coefficients) controlling the rate of the leakage. The groundwater leakage boundary condition can be defined using a constant value, a uniform time series (from .dfs0 file) or using a spatially- and time-varying file (.dfs2 file).

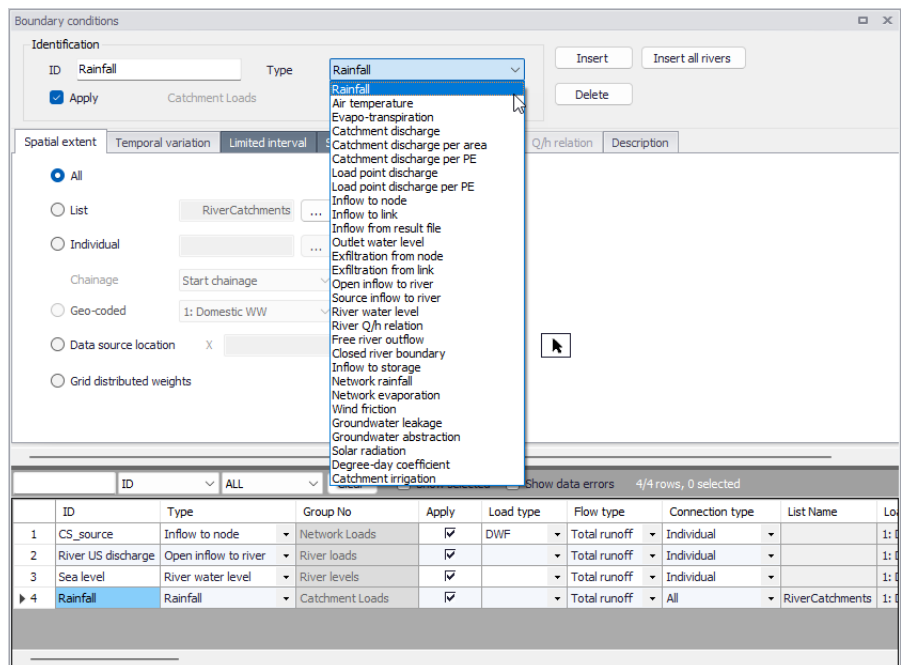

Figure 7.1 Hydraulic Boundary Conditions Dialog

### Defining HD Boundary conditions

Below are steps for defining basic HD boundary conditions in MIKE+.

1. Insert a boundary condition using the 'Insert' button on the upper right part of the Boundary Conditions editor. It is recommended to specify a

descriptive ID for the new boundary condition.

The screenshot shows a software window titled "Boundary conditions". It has an "Identification" section with an "ID" field containing "Rainfall station 1" and a "Type" dropdown menu set to "Rainfall". Below this is a checked "Apply" checkbox and a "Catchment Loads" label. On the right side, there are three buttons: "Insert" (highlighted with an orange box), "Insert all rivers", and "Delete".

2. Define the boundary condition type via the Type dropdown list. The selected type influences subsequent data requirements for the boundary condition presented in the various tab pages in the editor.
3. Define the location or spatial extent for the boundary condition in the Spatial Extent tab page.
4. Define the values for the boundary condition item in the Temporal Variation tab page of the editor.
5. Ensure the 'Apply boundary' checkbox is ticked if the boundary condition shall be used in subsequent simulations.

Special options and data requirements vary according boundary condition type defined, and so additional parameters/steps may be needed for other specific boundary types.

The subsequent sections describe the various options available in the various tab pages of the Boundary Conditions editor in greater detail.



Note: For river networks, boundary conditions are mandatory at river ends not connected to other parts of the modelled network. Rather than inserting and locating these boundary conditions manually, clicking the "Insert all rivers" button will add all the open boundaries of the river network to the boundaries table simultaneously. The created boundary conditions will be correctly located at the open ends, with a pre-defined boundary type: you then need to review the applied type, and specify the temporal variation of each boundary condition. If a boundary condition has already been defined at an open end, it will be kept unchanged when using the button.

### 7.1.3 Spatial extent

The **Spatial Extent** enables the modeller to define the distribution of the boundary conditions. The distribution ranges from 'All' (e.g. all catchments or all rivers, depending on the boundary condition type), Individual (specified locations), 'List' of a selection of elements (pipes, nodes, rivers or catchment depending on the boundary condition type), 'Geo-coded' locations, 'Data source location' and "Grid distributed weights".

The application of 'All can be applied to applied to catchment boundaries ('Catchment discharge', 'Catchment discharge per area' and 'Catchment discharge per PE'). It can also be used for meteorological boundaries applied to



catchments ('Rainfall', 'Air Temperature' and 'Evapotranspiration') or to the network ('Network rainfall', 'Network evaporation', and 'Wind friction').

**Lists** can be used with various types of boundary conditions to assign the condition to multiple items at once. **Lists** apply for a set of e.g. catchments, rivers, nodes or links, contained in a defined selection. The selection must first be saved in the **Selection Manager**, and then selected in the boundary condition definition.

'**Individual**' applies for a single item (catchment, river, node or pipe), and requires a specification of the item ID.

'**Geo-coded**' option applies to 'Load point discharge' and 'Load point discharge per PE' and is used to assign **Load points** (typically DWF) geo-coded to the network nodes. User can select which one of the geo-coded load categories applies for this boundary condition.

Further information regarding the Geo-coding of loads is discussed specifically under the 'Load Points' help section.

'**Data source location**' allows assigning the XY coordinates of a rainfall gauge to the measured time series. With this option, each catchment will be assigned the closest rainfall time series. If one rainfall boundary condition is defined by 'Data source location', then all other catchment rainfall boundary conditions must also be defined with the same location type.

'**Grid distributed weights**' can be used to assign spatially varying rainfall data. The application of 2D radar data as input for runoff computations requires that rainfall data are defined in DHI's *dfs2* format files. MIKE 1D will automatically distribute the rainfall to individual catchments and apply it to the runoff computation.



Note: If a load is connected to a link, it will be uniformly distributed over all computational grid H-points along the link.

#### 7.1.4 Temporal variation

The temporal variation describes how the boundary condition value changes in time. It can either use a constant value, a cyclic value or a time series.

Depending on the boundary condition type, the units are representative units and automatically updated.

If a cyclic temporal variation is to be applied, a pattern is also needed. The help section for 'Repetitive profiles' provides a more detailed description of the design and application of patterns and profiles.

The Time-series temporal variation requires a compatible time series file for input. The standard time-series file format is '.DFS0'. Press the '...' button to

create a new time series. Press F1 from the time series editor to get more detailed information on the various settings of the time series.

For 'Inflow from result file' boundary conditions, the time series file can also be a .res1d file from a previous Rainfall-runoff simulation. It can alternatively be a .dfs0 time series file, or a SWMM result file (regular .out file or outflow interface file in .txt format). When selecting a SWMM result file, a connection type must also be selected:

- Matching nodes names: time series from the SWMM result file will be applied as boundary conditions to nodes with the same name in the MIKE 1D simulation.
- Matching catchment and node names: catchment results from the SWMM result file will be applied as boundary conditions to MIKE 1D nodes, where the MIKE 1D node has the same name as the SWMM catchment in the result file.
- From catchment connections: the connection between SWMM catchment runoff results and MIKE 1D nodes is defined in the 'Catchment connections' editor.

For the Grid distributed weights' spatial extent, the input file must be a time-varying 2D grid file with dfs2 format.

For 'Load point discharge' and 'Load point discharge per PE' boundary conditions, the condition can be either constant or cyclic, and the value is specified in the 'Load points' editor.

For 'Wind friction' boundary conditions, a temporal variation must be specified for both the wind velocity and the wind direction. They are specified in their respective tabs and can both be either constant or varying in time. The direction is expressed in degrees in clockwise direction from north.

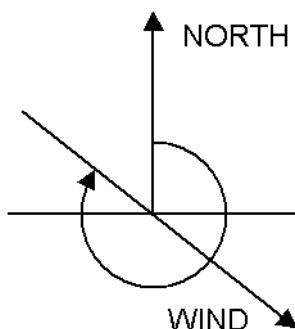

Figure 7.2 Definition of Wind field direction





### 7.1.5 Limited interval

The limited interval function allows the a specific time definition of when the boundary item is applied.

If a limited validity interval is to be applied to a boundary, then check 'Use limited validity'. It is then necessary to define the start and end date & time of the validity period.

### 7.1.6 Scaling factor

The Scaling factor tab is used to apply a scale factor for the hydraulic load. This can be used to add a climate factor.

For 'Wind friction' boundary conditions, the scale factor for the wind velocity can be specified in the 'Wind scaling factors' editor.

### 7.1.7 Distributed weights

The 'Distributed weights' tab is used to compute and review the weights, used in combination with rainfall boundary conditions defined with the spatial extent type 'Grid distributed weights' (using input 2D radar data) or 'Data source location' (locating time series from their rain gauge coordinates). From this tab it is possible to check the distributed weights per catchment and adjust if desired.

With 'Grid distributed weights' boundaries, all catchments covered by the grid will be presented in the table. Catchments might be presented in several entries if multiple grid points cover its entirety.

There are two text fields which will display the most important data for the loaded boundary condition selected; grid file name and selected item name.

The table shows the connected grid cells (coordinates i and j) and the calculated weight percentage covering the catchment per grid cell. These percentages fractions should add up to a 100 per cent for each catchment.

The table is dynamic and shows the selected boundary condition data. It allows to insert new connecting grid cell by right clicking, or by typing a new catchment name in the last row.

The 'Compute' button allows to compute the weights for either all catchments or a selection of catchments, as well as for the new added grid points (not updated).



Boundary conditions

Identification

ID: RainBC Type: Rainfall

Apply Catchment Loads

Insert Delete

Spatial extent Temporal Variation Limited interval Scaling factor Distributed Weights Description

C:\Users\fit\Desktop\2DBase\_1\_RAINF H Water Depth

Catchment ID	I	J	Weight
imp1	234	131	0,000262398320650...
imp1	234	132	0,000262398320650...
imp1	234	133	0,000262398320650...
imp1	235	111	0,000262398320650...
imp1	235	112	0,000262398320650...

... All Compute

There are atchments not fully covered by the grid file: imp1, perv1

ID ALL Clear Show selected Show data errors 1/2 rows, 0 select

ID	Boundary type	Group No	Apply Boundary	Load type
1 RainBC	Rainfall	Catchment Loads	<input checked="" type="checkbox"/>	Storm Runoff
2 Network loads input file - Runoff_1	Inflow from result file	Network Loads	<input checked="" type="checkbox"/>	

Figure 7.3 The 'Distributed weights' tab for a grid-distributed weights boundary condition

With 'Data source location' boundaries, the table is used only when the rainfall distribution type selected in the 'Simulation setup' editor (for the active simulation ID) is either 'Thiessen polygons weighting' or 'Inverse distance weighting'. The table will list all catchments having a positive weight associated to the active rainfall boundary conditions (catchments outside the Thiessen polygon surrounding the rain station, or beyond the search radius for the interpolation, are not listed in the table).

Text information above the table displays the weighting method selected in the active simulation ID, as well as the time series file name and item name used in the current boundary condition.

The 'Compute' button computes the weights for all the rainfall boundary conditions. The table can then be reviewed and updated if necessary. New rows can be added to the table by right-clicking, or by typing a new catchment name in the last row. If the tables of weights are left empty, the weights for all the rainfall boundary conditions will be computed when starting the simulation.



The 'Weights overview' button opens another table providing the complete list of weights, for each catchment and for each rainfall station.

Spatial extent	Temporal variation	Limited interval	Scaling factor	Distributed weights	Q/h relation	Description
Inverse distance weighting		Input file		Sirius_IDF_rainfall.dfs0	F=1	
	Catchment ID	Weight [0]				
▶ 1	S14150801	0.55085502239213169				
2	S14150802	0.54451956824817915				
3	S14151901	0.5508905700396256				
4	S14152801	0.555401350013485				
5	S14152901	0.55824959345549885				
6	S14153901	0.55769450293716571				
7	S14154801	0.56348891369563414				

Figure 7.4 The 'Distributed weights' tab for a 'Data source location' boundary condition

During the simulation with 'Data source location' boundaries, the interpolated rain time series  $\hat{R}$  related to a catchment  $C$  is a weighted time series obtained from the various boundary time series  $Ts_i$ :

$$\hat{R} = W_1 \cdot Ts_1 + W_2 \cdot Ts_2 + \dots + W_p \cdot Ts_p \quad (7.1)$$

More details follows for the two available methods.

### Inverse Distance Interpolation Method

Consider a plane with XY coordinates, the Catchment centroid coordinate  $(X_C, Y_C)$  and the sets of rain station measurements:  $(Mx_1, My_1)$  corresponding to the time series  $Ts_1$ ,  $(Mx_2, My_2)$  corresponding to the time series  $Ts_2, \dots$ ,  $(Mx_p, My_p)$  corresponding to the time series  $Ts_p$ . Then the weight of each time series  $Ts_j$  is simply weighted proportionally to one over the square distance  $D(C, Ts_j)$  between the catchment center  $(X_C, Y_C)$  and the measurement location  $(Mx_j, My_j)$ :

$$W'_j = \frac{1}{D(C, Ts_j)^2} \quad (7.2)$$

After computing all the weights for each measurement station, they need to be normalized so they sum up to 1:

$$W_j = \frac{W'_j}{\sum_j W'_j} \quad (7.3)$$

The normalized weights are used to compute the interpolated rain of the catchments.

## Thiessen Interpolation Method

The Thiessen (or Voronoi) interpolation is another simple way to decide the domain of influence of the measurements towards the catchments. A Thiessen polygon  $Tp_i$  is defined for each geolocated measurement time series  $TS_i$ , and it is roughly defined as the set of points in the plane for which the closest measurement location is the one defined by the geolocation of  $TS_i$ . Therefore, the edges of the Thiessen polygons correspond to equidistant lines between neighbor measurement locations. The overlapping of all these equidistant lines between all neighbor time series will define a set of polygons  $Tp_1, Ts_2, \dots, Ts_p$ .

Consider the  $n$  Catchments  $C_1, C_2, \dots, C_n$  and the  $p$  measurement stations  $M_1, M_2, \dots, M_p$ . In the picture below, as example, 4 catchments and 6 stations:

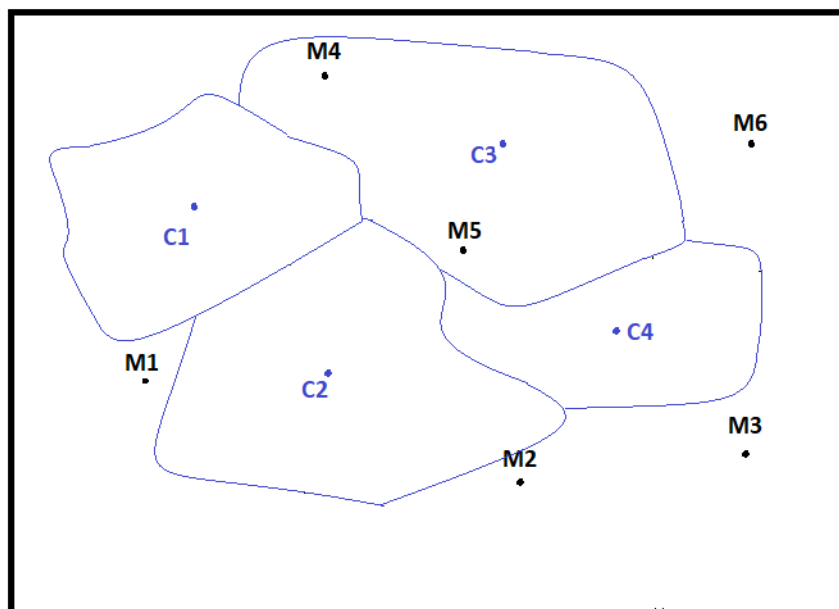

Figure 7.5 Example of catchments with geolocated rainfall stations

The stations  $M_1, M_2, \dots, M_p$  and the surrounding box divide the plane into Thiessen/Voronoi polygons according to the distances to stations, as shown on the next figure.

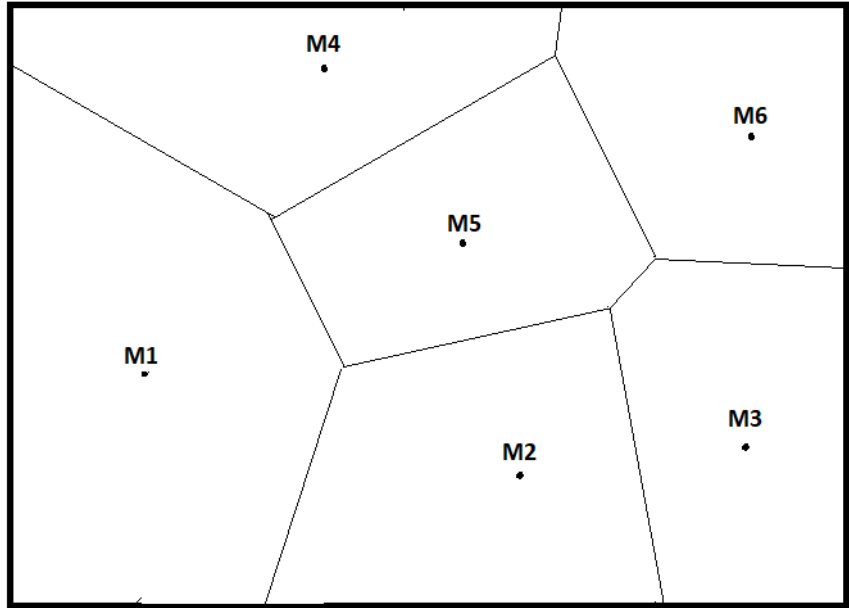

Figure 7.6 Thiessen polygons created from rainfall stations

The superposition of the Thiessen polygons divides the plane into areas where the closest station is the governing measurement which is consider for the polygon.

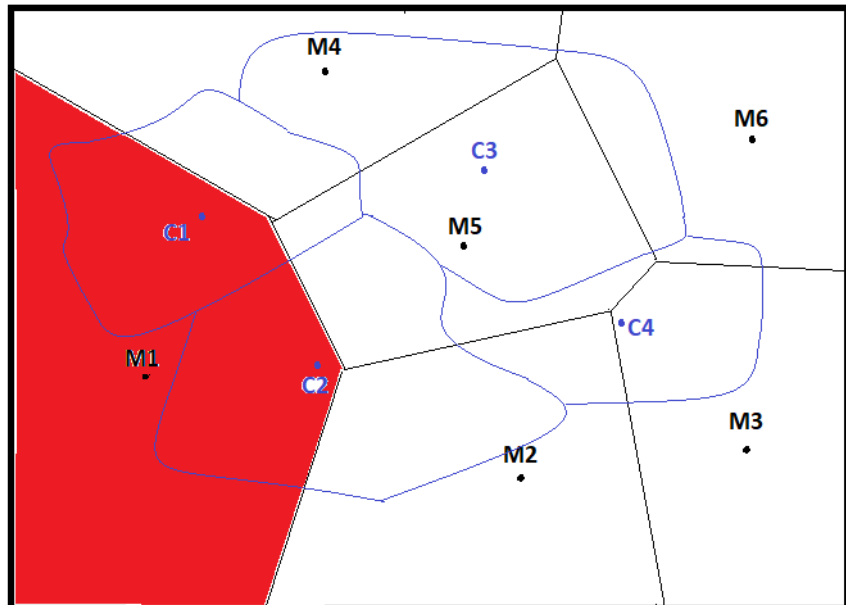

Figure 7.7 Thiessen polygon related to rainfall measurement station M1, in red



The weight related to catchment  $i$  and station  $j$  is the ratio between the Intersection of the catchment  $i$  and the Thiessen polygon  $j$ :

$$W_{ij} = \frac{\text{Area}(C_i \cap P_j)}{\text{Area}(C_i)} \quad (7.4)$$

For the case of station 1 and catchment 1 the weight is the ration between the green area, and the sum of the green and brown areas:

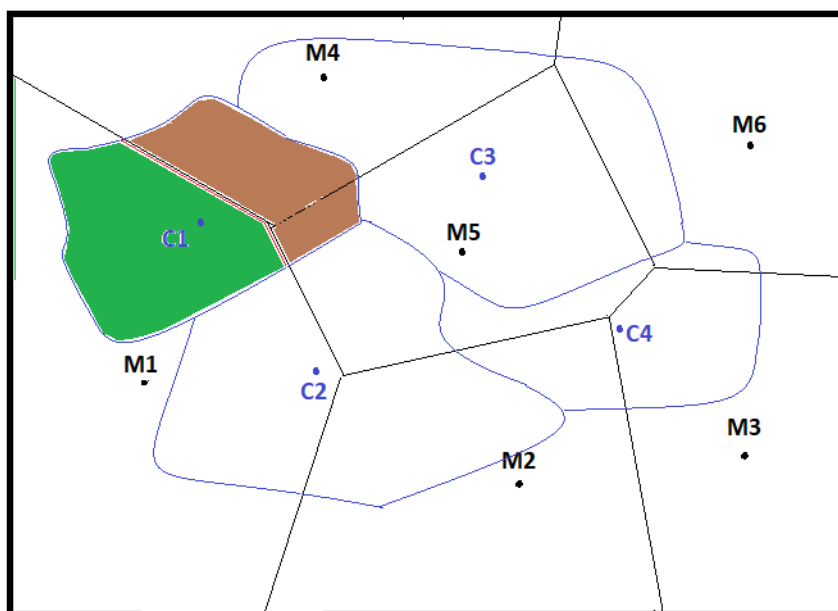

Figure 7.8 Thiessen weight calculation for catchment C1

### 7.1.8 Q/h Relation

The Q/h Relation tab page is relevant for 'River Q/h Relation' boundary condition types. It is where the corresponding Q/h relation table for a 'River Q/h Relation' boundary condition is defined (Figure 7.9).

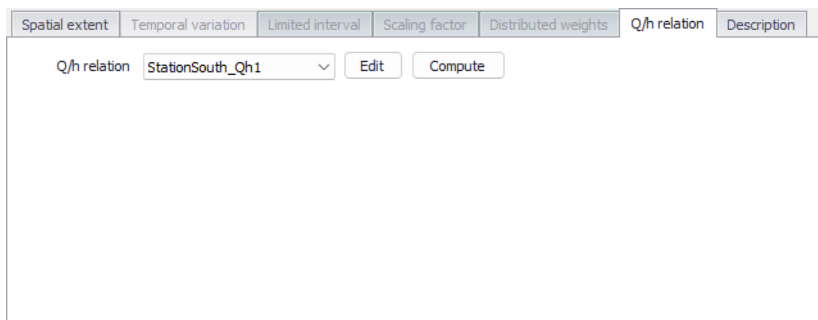

Figure 7.9 The Q/h Relation tab page relevant for River Q/h Relation boundary condition types

Select the appropriate Q/h relation table for the boundary condition from the 'Q/h Relation' dropdown list.

Use the 'Edit' button to access the 'Curves and Relations' editor, wherein one may edit or create various types of tabular data sets for the project.

Use the 'Compute' button to automatically compute the Q/h relation using the characteristics of the cross section located at the boundary location (a cross section must exist at this location before this tool can be used). The button opens the window below to control how to compute the Q/h relation.

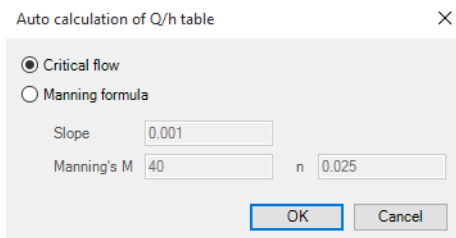

Figure 7.10 Automatic calculation of Q/h relations

H values in the Q/h relation are extracted from the processed data of the cross section whereas related Q values are computed either using the critical flow or the Manning formula. If the latter is chosen, the bed slope and Manning's value (Manning (M) or Manning (n)) must be specified.

In case the critical flow formula is used, Q is calculated from:

$$Q(h) = A(h) \sqrt{g \frac{A(h)}{W(h)}} \tag{7.5}$$



In case of uniform flow by Manning's formula, Q is calculated from:

$$Q(h) = Conv(h) \cdot \sqrt{I} \quad (7.6)$$

where:

$Q(h)$  is the level dependent discharge

$A(h)$  is the level dependent area (from Cross section processed data)

$W(h)$  is the level dependent width (from Cross section processed data)

$I$  is the bed slope

$Conv(h)$  is the level dependent conveyance calculated as a function of the resistance type defined in cross section, in the Raw data tab, as described below.

If the resistance type is set to Relative Resistance:

$$Conv(h) = M_{QhTool} \cdot A(h) \cdot R^{2/3} \quad (7.7)$$

If the resistance type is set to Manning's M:

$$Conv(h) = M(h) \cdot A(h) \cdot R^{2/3} \quad (7.8)$$

If the resistance type is set to Manning's n:

$$Conv(h) = \frac{1}{n(h)} \cdot A(h) \cdot R^{2/3} \quad (7.9)$$

If the resistance type is set to Chezy or Darcy-Weisbach:

$$Conv(h) = C(h) \cdot A(h) \cdot \sqrt{R(h)} \quad (7.10)$$

where:

$M_{QhTool}$  is the Manning number defined in the 'Auto calculation of Q/h table' dialog

$M(h)$ ,  $n(h)$  and  $C(h)$  are the respective resistance numbers extracted from the Resistance column in the cross sections Processed data.





## 7.1.9 Description

It is possible to provide a description of the boundary condition and load type using the Description tab.

## 7.2 Wind Scaling Factors

The wind scaling factor is a multiplication factor which is multiplied to the wind velocity. Wind scaling factors may be defined both as a global value and as distributed values at user-defined locations (chainage points).

The 'Wind scaling factors' editor will appear in the Setup tree view, if at least one Wind friction boundary condition exists.

### Default factor

A default wind scale factor is defined at the top of the editor. It is applied throughout the channels network unless local values have been defined.

### Local factors

By using local wind scaling factors, it is possible to adjust the wind shear stress to reflect local variations within the domain. Local values overwrite the default value. Local values are applied at specific locations defined by the channel ID and a chainage value.

Local values are added or deleted using the 'Insert' or 'Delete' buttons above the table.

ID	River ID	Chainage [m]	Wind scale factor [0]
1	Channel_1	260	1.25

Figure 7.11 The Wind scaling factors editor



Note: If two or more local values are defined on the same channel, the values in intermediate calculation points will be calculated by linear interpolation.



## 7.3 Leakage coefficients

When the groundwater leakage boundary condition is included, the coefficients (global and local coefficients) controlling the rate of the leakage must be specified in the 'Leakage coefficients' editor.

Leakage coefficients may be defined by a default (global) leakage coefficient or by local coefficients that override the default value at specific locations. Hence, if leakage is to be included only at some locations, then a default value of 0 must be defined and the local reaches where groundwater leakage takes place must be defined in the Local coefficients table.

The Leakage coefficients' editor will appear in the Setup tree view, when a 'Groundwater leakage' boundary condition exists.

### Default coefficient

A default leakage coefficient is defined at the top of the editor. It is applied throughout the channels network unless local values have been defined.

### Local coefficients

By using local leakage coefficients, it is possible to adjust the flow towards the groundwater, to reflect local variations of soil characteristics within the domain. Local values overwrite the default value. Local values are applied at specific locations defined by the channel ID and a chainage value.

Local values are added or deleted using the 'Insert' or 'Delete' buttons above the table.



**Note:** If two or more local values are defined in the same river branch, the intermediate value(s) will be calculated by linear interpolation.

## 7.4 Water Quality Boundary Condition Properties

This editor is only available if Water Quality module is active. Water can transport other material such as pollutants, heat, organisms, as well as other properties, such as pH, conductivity, turbidity, etc. The transport of these properties may be modelled in MIKE+, requiring definition of these WQ properties associated with water load boundary conditions. WQ boundary properties for boundary conditions for CS and River network models are defined in the WQ Boundary Properties editor (Figure 7.12).

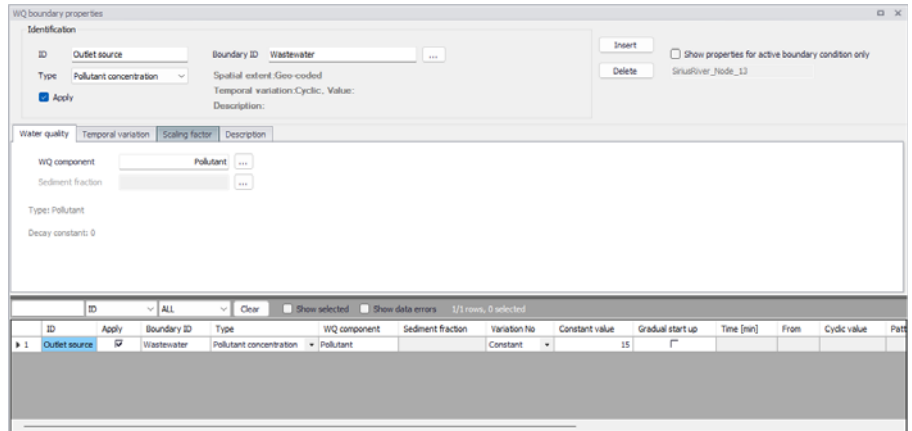

Figure 7.12 The WQ Boundary Properties editor

### 7.4.1 Identification

The top section of the WQ Boundary Properties editor contains the Identification group box where one defines general properties of WQ boundary setups (Figure 7.13).

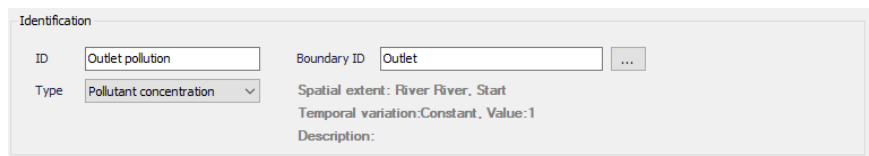
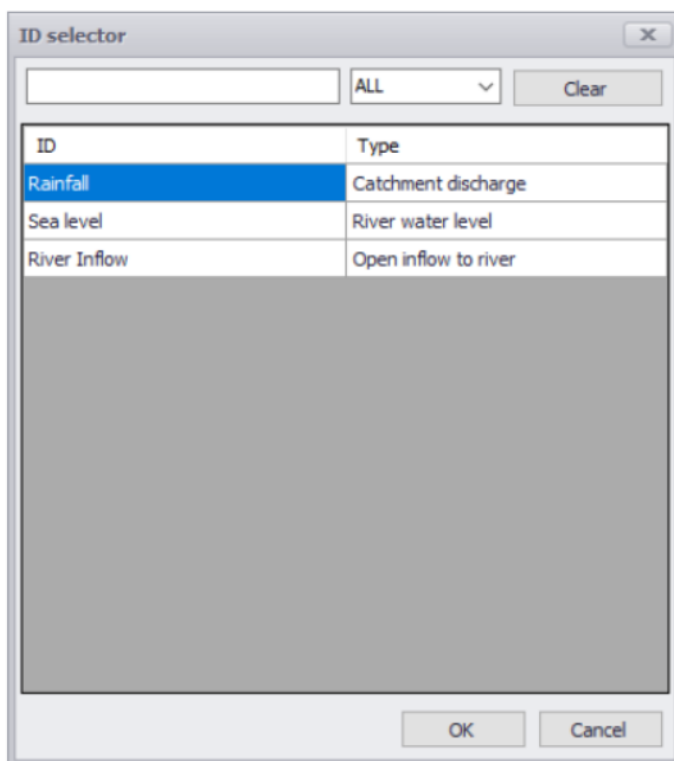

Figure 7.13 The Identification group box in the WQ Boundary Properties editor

To define a WQ boundary property in the project:

1. Use the 'Insert' button to add a new WQ boundary property to the editor.
2. One may edit the ID for the newly-added WQ boundary property to make it more descriptive.
3. Associate the WQ property to an HD boundary condition via the 'Boundary ID' input box. Click on the ellipsis button to access the Selector window, which lists existing HD boundary conditions that may be associated with WQ properties.



A WQ boundary property must be connected to a hydraulic boundary condition. A hydraulic boundary condition can be used with a hydraulic load set to 0 to only add a Pollutant Load or Sediment Load.

4. Define the WQ property Type from the drop-down list of possible types, which is associated with the WQ Component defined in the Water Quality tab page.
5. Define the WQ Component for the WQ boundary property in the Water Quality tab page of the editor.
6. Furnish information in the other tab pages of the editor as needed.

The top part of the editor also presents options for filtering the WQ boundary properties displayed in the editor.

Use the 'Show properties for active boundary condition only' option to display only the WQ properties associated with the active HD boundary condition in the Boundary Conditions editor. The ID for the active HD boundary condition is displayed in the text box below the option. If the option is inactive, all WQ boundary properties are shown in the editor

 Show properties for active boundary condition only  
Outlet

The available types of WQ properties are:

### Pollutant concentration or load

The pollutant will be added with the concentration or load specified on the Temporal Variation tab.

### Microorganism

The component is added as a micro-organism load, used for bacteria and pathogens.

### Temperature

The component represents the temperature, the unit will be adjusted according to the unit system specified for the model.

### pH

The component is related to the water pH, a measure of how acid or basic the water is.

### Salinity

The component will reflect the measure of salts dissolved in water.,

### Water Age

This option allows for water with specified age to enter the network.

### Water Blend

This option allows for water with specified mixing ratio to enter the network.

### Other Type of AD component

The property type 'Other' can be used in combination with WQ components defined with the type 'Other' in the 'WQ components' editor. This type is to be used for component types not available in the predefined list of types, in the 'WQ components' editor.

### Sediment concentration

The sediments will be added with the concentration (mass/volume) specified on the Temporal Variation tab.

The simulation engine will multiply the water discharge at the boundary location to define the total mass entering the network at the boundary location.

### Sediment load

The sediments will be added with the load (volume/time) specified on the Temporal Variation tab.



The specified load is directly applied in the simulation and the water discharge at the boundary location is hence not used to determine the mass inflow to the model.

### Bed level

This property describes the elevation of the bed (surface of the sediments layers) at the boundary. For this type of boundary property, no sediment fraction needs to be specified (the boundary property applies to the boundary as a whole, no matter how sediment fractions are distributed at this location).

This type of property is only supported for open boundaries (network ends), but not for e.g. sources along the network.

### Bed level change

This property describes the relative change of bed level (surface of the sediments layers) at the boundary. For this type of boundary property, no sediment fraction needs to be specified (the boundary property applies to the boundary as a whole, no matter how sediment fractions are distributed at this location).

This type of property is only supported for open boundaries (network ends), but not for e.g. sources along the network.

### Mixing

This option can be applied for boundaries where outflows from the model area take place, and where the boundary can become an inflow during the simulation (e.g. due to tidal conditions). When enabling the mixing property for a boundary condition, when the boundary becomes an inflow, the concentration at the boundary is not null but is estimated as a function of the concentration back in time when the boundary was an outflow. This is estimated using the halving time specified in the 'Mixing' tab,

The 'Apply' check box allows the user to toggle the Active status of the WQ boundary on and off. The simulations will omit all WQ boundary conditions that are not active.

## 7.4.2 Water quality

Define WQ Components associated with WQ boundary properties in the Water Quality tab page of the editor (Figure 7.14).

Possible components are listed in the ID Selector window accessed via the ellipsis button. The dialog lists components that have been defined in the WQ Components editor.



Figure 7.14 The Water quality tab in the Water Quality editor.

The Sediment Fraction setup associated with a WQ boundary property used in Sediment Transport computations is also defined in the Water Quality tab page. The ellipsis button presents a selector window listing sediment fraction definitions in the Sediment Fractions editor.

### 7.4.3 Temporal Variation

Figure 7.15 Temporal variation tab in Water Quality editor.

A water quality boundary condition can have a different temporal variation than the hydraulic boundary condition it is connected to. It can be constant, cyclic, a time series temporal variation, table concentration and SWQ.

Dependent on the water quality type, the units are representative and automatically updated.

If a cyclic temporal variation is to be applied, a pattern is also needed.

The Time-series temporal variation requires a compatible time series file for input. The standard time-series file format is '.DFS0'.

The table concentration allows to specify a variation of pollutant loads based on a runoff -concentration varying relation.

The temporal variation can also be defined through a Storm Water Quality method, build-up/ wash-off or EMC, for more details please refer to the Water Quality Module.



### 7.4.4 Scaling factor

The scaling factor allows to add a global factor to the load. The Default value is 1.

### 7.4.5 Mixing

This option can be applied for boundaries where outflows from the model area take place, and where the boundary can become an inflow during the simulation (e.g. due to tidal conditions).

When the boundary becomes an inflow, the concentration at the boundary is adjusted according to:

$$C = C_{bf} + (C_{out} - C_{bf})e^{-t_{mix} \cdot k_{mix}} \quad (7.11)$$

Where:

$C_{bf}$  is the concentration specified at the boundary location

$C_{out}$  is the computed concentration at the boundary immediately before the boundary became an inflow

$t_{mix}$  is the time since the boundary became an inflow

$k_{mix}$  is the mixing coefficient computed as a function of the halving time:  
 $k_{mix} = \ln(2) / T_{halving}$

$T_{halving}$  is the user-defined time specified in the 'Mixing' tab.

When outflows occur at the boundary, the boundary condition is defined as:

$$\frac{\partial^2 C}{\partial x^2} = 0 \quad (7.12)$$

### 7.4.6 Description

The Description tab allows the user to add text data to the specific WQ boundary condition.

## 7.5 Load Point

The allocation of geographically determined load points to the nodes and, or links of a collection system model is defined through the Load Points section. The load points are geographical point features, typically representing a cate-





gorised wastewater load, such as domestic wastewater, commercial / industrial wastewater and infiltration.

It is possible to modify the additional categories to provide a tailored coding system to replicate the water loadings of the catchment.

	ID	Apply	X [m]	Y [m]	Load category	Flow [m <sup>3</sup> /d]	Person equ.
▶ 1	864:S14150801_WW	<input checked="" type="checkbox"/>	95847.4008789063	103108.882324219	1: Domestic WW	54.54304	
2	865:S14150802_WW	<input checked="" type="checkbox"/>	95985.0902709961	103018.910888672	1: Domestic WW	54.494	
3	866:S14151901_WW	<input checked="" type="checkbox"/>	95971.2302856445	103182.031677246	1: Domestic WW	63.10365	
4	867:S14152801_WW	<input checked="" type="checkbox"/>	95877.4896850586	103246.906311035	1: Domestic WW	28.59082	

Figure 7.16 Load points grid

The 'Apply' check box allows the user to toggle the Active status of the load point on and off. The simulations will omit all load points that are not active.

There are 3 sub-tabs within the 'Load point' tab, 'Geometry', 'Load point connection' and Description.

### 7.5.1 Geometry

Within the 'Geometry' tab, the load can be categorised and its flow and number of person equivalents can be specified.

When the load is associated to a 'Load point discharge' boundary condition, the boundary condition value is the flow value specified for the load. When the load is associated to a 'Load point discharge per PE' boundary condition, the boundary condition value is the flow value multiplied by the number of person equivalents specified for the load.



## 7.5.2 Load point connection

Load points can be connected to the model network through nodes and links, each load will be coupled to a single network element.

ID	X coordinate [m]	Y coordinate [m]	Load category	Load flow [m <sup>3</sup> /d]	Load units [Q]
1	-686976,627153363	-1056061,31730978	1: Domestic WW	86400	10

Figure 7.17 Load point connection

The connections can be made via the asset ID Selector (grid selection) or by map selection.

If using a link connection for the Load point, it is possible to define the chainage start and end points.

## 7.5.3 Description

The description tab enables the modeller to record load point information.



Load points

Identification

ID:  X:  Y:

Geometry | Load point connection | Description

Description:

Data source:

Asset ID:

Owner:

Location:

Date:

ID	X coordinate [m]	Y coordinate [m]	Load category	Load flow [m <sup>3</sup> /d]	Load unit
1	-686976,627153363	-1056061,31730978	1: Domestic WW	86400	

Figure 7.18 Load point description tab

## 7.6 Repetitive Profiles

The 'Repetitive Profile Editors' can be used for generating dimensionless, cyclic time series ('repetitive profiles') with a fixed time resolution of one hour. E.g., it can be applied for defining diurnal profiles that can describe the Dry Weather Flow (DWF) from a specific catchment. An unlimited number of repetitive profiles can be applied to different groups of catchments. For example, an industrial area will have a different dry weather flow (DWF) description to rural or residential area. DWF profiling may also vary according to the time of week and holidays.

There are four discrete parts forming the repetitive profiles:

- Diurnal patterns - used for specifying diurnal patterns
- Cyclic profiles - used for coupling of individual diurnal patterns with profile calendar definition
- Profiles calendar - used for coupling of individual diurnal patterns with profiles calendar definition
- Special days - used for specifying days that are to be considered as exceptions to the calendar (e.g. the 1st of January)



## 7.6.1 Diurnal patterns

A diurnal pattern consists of the pattern ID and non-dimensional coefficients (multipliers) varying with the time of the day.

A Delta T (time step) is also required, if the time information is to be automatically distributed for the entire day with a constant interval.

Figure 7.19 shows an example of a diurnal pattern. A new pattern is created by using the 'Insert' button. The common workflow is then to define the Delta value (minutes). The Delta value represents the interval distribution for the pattern. The 'Distribute' button creates the intervals determined by the Delta value assigned. For example, a Delta value of 60min returns 24 hourly intervals, a Delta value of 240 will return 6 x 4 hour intervals. The dimensionless coefficient is inserted under the 'Multiplier' column.

The 'Normalize' button adjusts the multiplier values so that their average value is equal to 1, but the relative weightings are maintained.

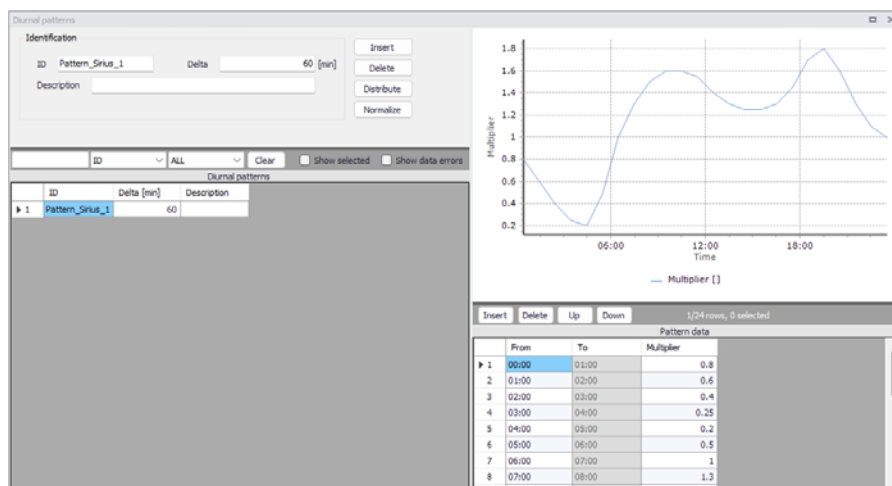

Figure 7.19 Diurnal pattern editor

Patterns times can alternatively be created or edited using the 'Insert' and 'Delete' button below the plot, instead of using the 'Distribute' button. The pattern's time steps don't necessarily have to be equidistant.

The pattern's data table shows the 'From' and 'To' time of the day relating to the corresponding multiplier. Only the 'From' time needs to be specified. The 'To' time is automatically filled with information from the next time step.

Please refer to the 'Cyclic profiles' options for more information about how the pattern is applied in the simulation.



## 7.6.2 Cyclic profiles

A cyclic profile links a diurnal pattern with the relevant calendar definition.

Each cyclic profile requires an ID with a defined 'Diurnal Pattern' and 'Calendar'. In addition, the profile requires input regarding the interpolation of the pattern, either by 'linear interpolation', or 'no interpolation'. No interpolation will apply a step function between the diurnal pattern values.

Figure 7.20 shows the Cyclic Profile editor. The visualisation shows at a glance how the profile will look (monthly or weekly) with the diurnal pattern coupled to the selected profile calendar. The Cyclic Profile example shows a 'Residential' diurnal profile with a 'Weekday' profile calendar.

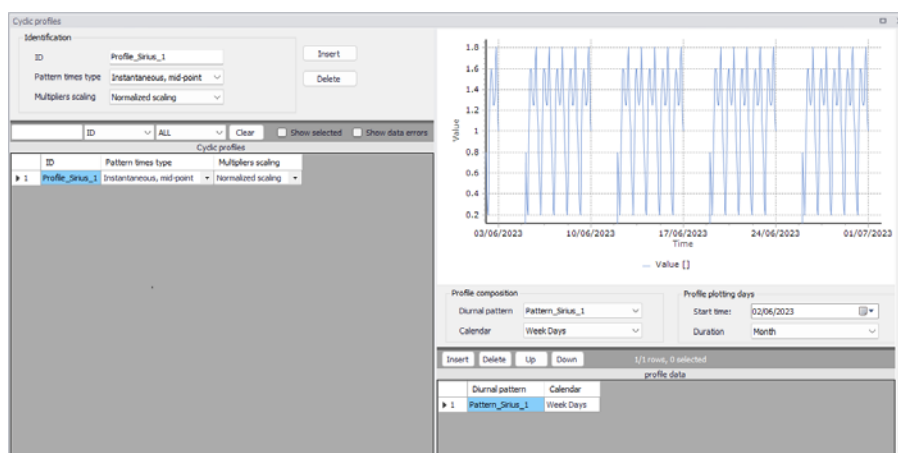

Figure 7.20 Cyclic Profile

The 'Pattern times type' controls how the pattern's multipliers apply for each of the pattern's time step:

- Step values: The multiplier in the Diurnal pattern at a given row remains constant between the 'From' and 'To' times. This leads to a stepped pattern.
- Instantaneous, mid-point: The multiplier in the Diurnal pattern at a given row is applied in the middle of the time interval for that row, and a linear interpolation applies between consecutive multipliers.

The 'Multipliers scaling' option controls whether the multipliers are scaled / adjusted during the simulation or not:

- Normalized scaling: The multipliers are rescaled, such that their average value becomes 1 over a day. Negative multipliers are not allowed in this case.



- No scaling: The multipliers are kept unchanged. Negative multipliers are allowed.

### 7.6.3 Profiles calendar

The purpose of the profiles calendar is to specify when the diurnal patterns are to be applied, e.g, only during summer, only February, only on weekdays, only on each first in the month, etc.

Profile calendars specify when the diurnal profile pattern is to be applied, and can be defined in three primary formats, Weekdays, Dates and Months.

There is scope to apply multiple calendar formats to create very specific calendar formats, if required.

ID	Week days	Monday	Tuesday	Wednesday	Thursday	Friday	Saturday	Sunday
1 weekends	<input checked="" type="checkbox"/>	<input type="checkbox"/>	<input type="checkbox"/>	<input type="checkbox"/>	<input type="checkbox"/>	<input type="checkbox"/>	<input checked="" type="checkbox"/>	<input checked="" type="checkbox"/>
2 weekday	<input checked="" type="checkbox"/>	<input checked="" type="checkbox"/>	<input checked="" type="checkbox"/>	<input checked="" type="checkbox"/>	<input checked="" type="checkbox"/>	<input checked="" type="checkbox"/>	<input type="checkbox"/>	<input type="checkbox"/>

Figure 7.21 Profiles calendar weekdays



Profile calendars

Identification

ID  Insert Delete

Weekdays Dates Months

Dates

<input checked="" type="checkbox"/> 1	<input checked="" type="checkbox"/> 8	<input checked="" type="checkbox"/> 15	<input checked="" type="checkbox"/> 22	<input checked="" type="checkbox"/> 29
<input checked="" type="checkbox"/> 2	<input checked="" type="checkbox"/> 9	<input checked="" type="checkbox"/> 16	<input checked="" type="checkbox"/> 23	<input checked="" type="checkbox"/> 30
<input checked="" type="checkbox"/> 3	<input checked="" type="checkbox"/> 10	<input checked="" type="checkbox"/> 17	<input checked="" type="checkbox"/> 24	<input checked="" type="checkbox"/> 31
<input checked="" type="checkbox"/> 4	<input checked="" type="checkbox"/> 11	<input checked="" type="checkbox"/> 18	<input checked="" type="checkbox"/> 25	
<input checked="" type="checkbox"/> 5	<input checked="" type="checkbox"/> 12	<input checked="" type="checkbox"/> 19	<input checked="" type="checkbox"/> 26	
<input checked="" type="checkbox"/> 6	<input checked="" type="checkbox"/> 13	<input checked="" type="checkbox"/> 20	<input checked="" type="checkbox"/> 27	
<input checked="" type="checkbox"/> 7	<input checked="" type="checkbox"/> 14	<input checked="" type="checkbox"/> 21	<input checked="" type="checkbox"/> 28	

ID ALL Clear  Show selected  Show data errors 1/2 rows, 0 se

ID	Week days	Monday	Tuesday	Wednesday	Thursday	Friday	Saturday	Sunday
1 weekends	<input checked="" type="checkbox"/>	<input type="checkbox"/>	<input type="checkbox"/>	<input type="checkbox"/>	<input type="checkbox"/>	<input type="checkbox"/>	<input checked="" type="checkbox"/>	
2 weekday	<input checked="" type="checkbox"/>	<input checked="" type="checkbox"/>	<input checked="" type="checkbox"/>	<input checked="" type="checkbox"/>	<input checked="" type="checkbox"/>	<input checked="" type="checkbox"/>	<input type="checkbox"/>	

Figure 7.22 Profile calendars dates

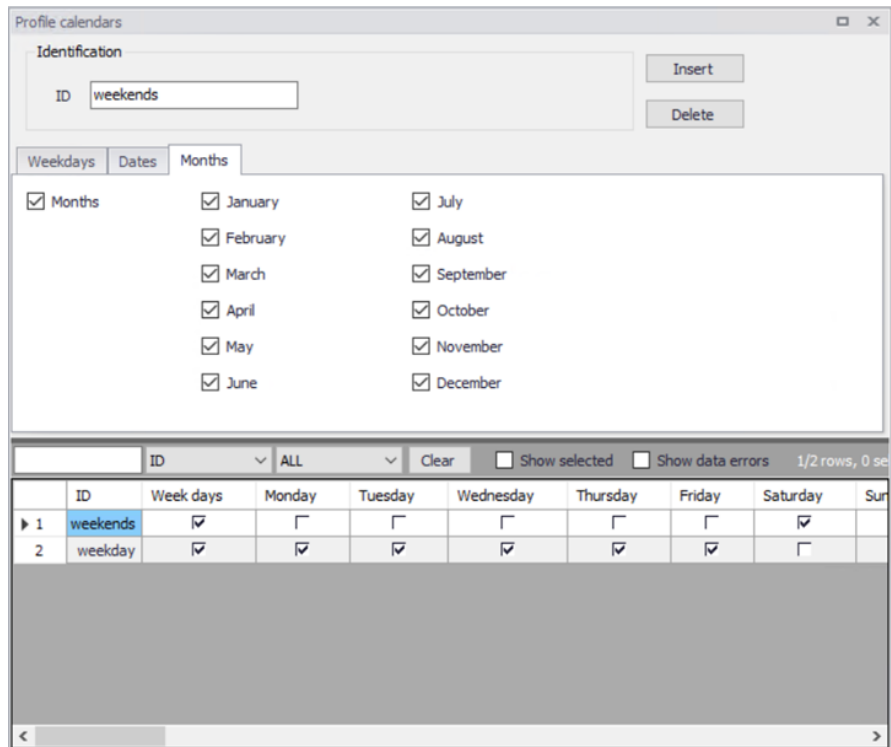

Figure 7.23 Profile calendar months

#### 7.6.4 Special days

The 'Special days' is used for the specification of individual days that should be considered differently than it is given by the profiles calendar.

For example, the 1st January (the New Year day) falls on a different day each year. Typically, holiday days diurnal profiles are more representative of Weekends. The 'special days' function can be used to assign the 1st January with a weekend diurnal pattern.

The special days have two categories, 'Unique date' and 'Every year'. An example of this is Easter day. The date of Easter varies each year, so the 'Unique date' would be more applicable.



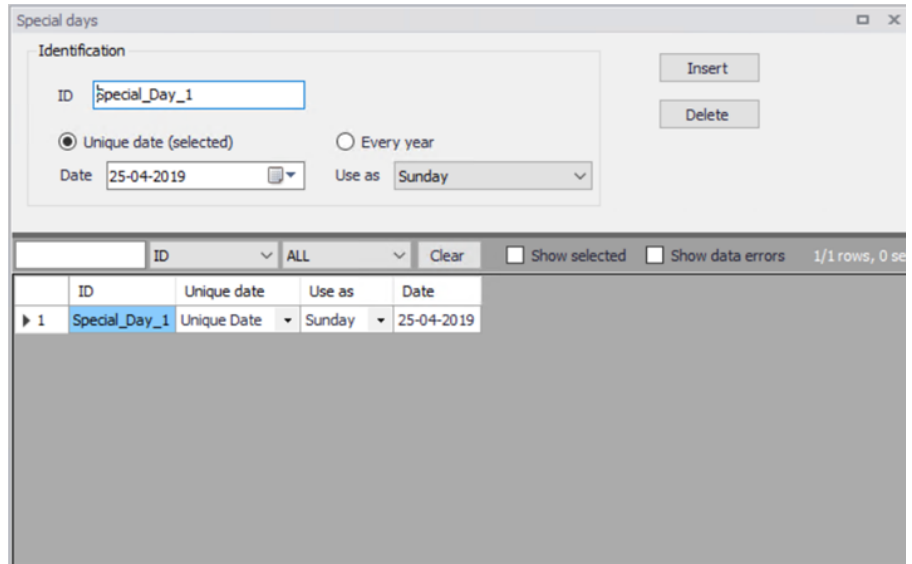

Figure 7.24 Special Days

The date calendar allows the user to select the desired date for a special day. The “Unique date (selected)” and “Every year” checkbox are used to specify the recurrence. Finally “Use as” allows the user to assign the variation pattern, weekday and weekend.

## 7.7 Boundary Overview

It is possible to visualize the time frame variation of all boundary conditions included in the model by means of the boundary overview dialog.

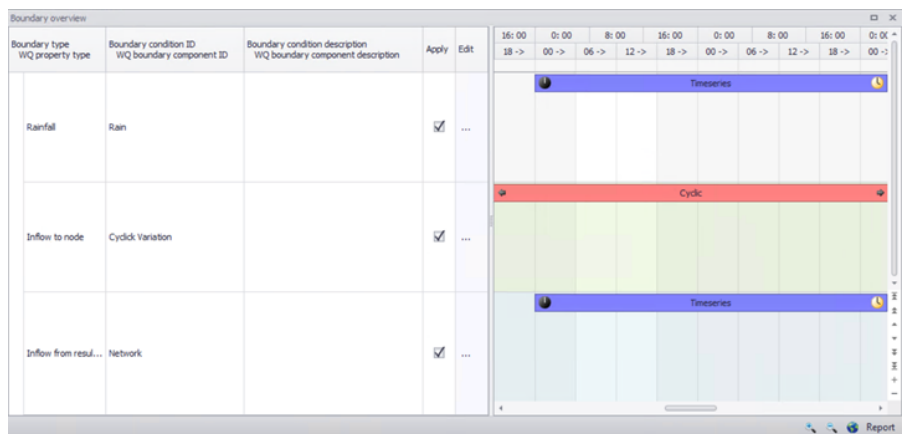

Figure 7.25 Boundary overview



The overview allow the user to apply boundary conditions and lead the user to the editor by clicking on “Edit”. The right side of the panel shows the time frame of the boundary condition.



## 8 Tables

The Tables Section in MIKE+ holds data for the following tabular data types:

- Curves and Relations
- Materials
- Outlet Head Loss
- On Grade Captures

### 8.1 Curves and Relations

In Tables|Curves and Relations (Figure 8.1), a number of tabular data used in other data dialogs are specified. These different types of tabular data are:

- Capacity Curve QH (used for Pumps)
- Capacity Curve QdH (used for Pumps)
- Pump Acceleration Curve (used for Pumps)
- Regulation Qmax(H)
- Regulation Qmax(dH)
- QH Relation (when specifying a QH relation for a node)
- Valve Rating Curve
- Time-Area Curve (used in Time-Area runoff model)
- Removal Efficiency (used for the efficiency curve for removal weirs)
- DQ Relation (used for Curb Inlets)
- QQ Relation (used for Curb Inlets and On Grade Captures)
- Capacity Curve QdH & Power
- Runoff Pollutants (used for SWQ)
- Basin Geometry (used for Basins)
- Generic control rule (used for actions in control rules)
- Control rule time series (used for actions in control rules)
- Undefined (general placeholder)

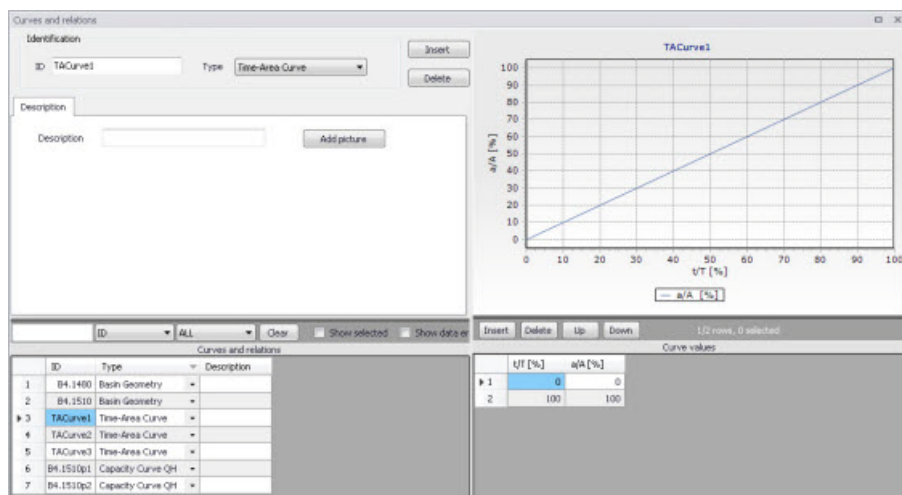

Figure 8.1 Curves and Relations Editor

There are 3 pre-defined Time-Area Curves in the database (TACurve1, TACurve2 and TACurve3), which should not be deleted.

Additional curves and relations are inserted under the Curves and Relations list (i.e. the primary table on the lower left corner of the editor) using the 'Insert' button at the top of the editor (Figure 8.2).

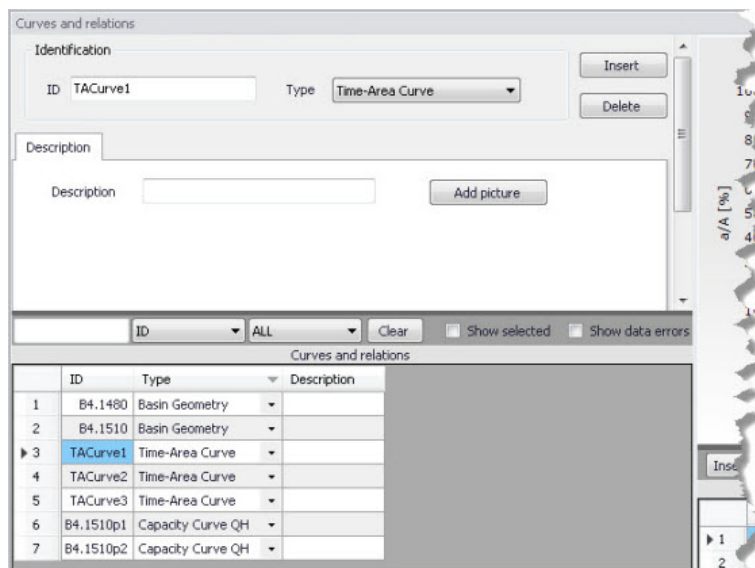

Figure 8.2 Primary table with the Curves and Relations list on the lower left side of the Curves and Relations Editor



After inserting a new tabular data item, define the corresponding data values under the Curve Values table (i.e. secondary table to the right of primary table) (Figure 8.3). Secondary table parameters/columns that should be filled vary depending on the curve and relation type.

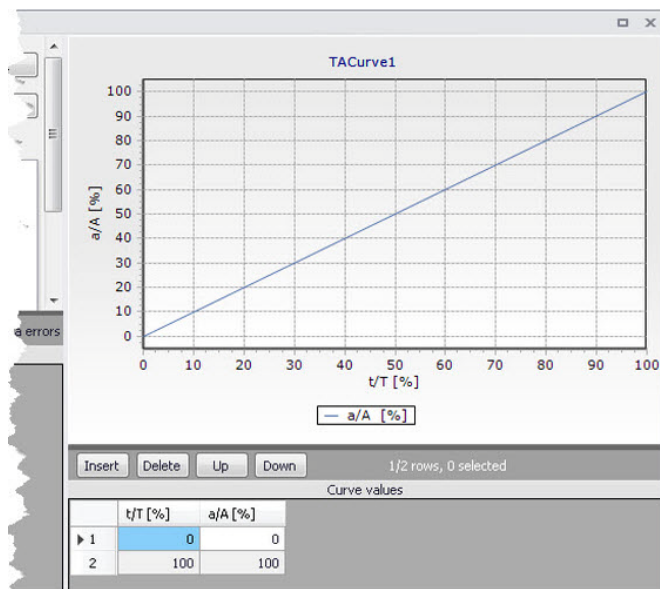

Figure 8.3 Secondary table containing Curves Values on the lower right side of the Curves and Relations Editor. Also shown is the tabular data plot above the secondary Curve Values table.

A plot of the tabular data is also shown on the upper right corner of the editor (Figure 8.3).

Table 8.1 Overview of Curves and Relations Editor attributes (Table ms\_Tab)

Edit field	Description	Used or required by simulations	Field name in datastructure
ID	Tabular data identifier	Yes	MUID
Type	Dropdown menu for selecting tabular data type	Yes	TypeNo
Description	User's descriptive information on the tabular data	Optional	Description



### 8.1.1 Capacity curves

It is possible to define two types of capacity curves in MIKE+; both are used to define pump operation.

The capacity curve can be a 'Capacity Curve QH' relation (for screw pumps) or 'Capacity Curve QdH' relation (for differential head pumps).

'H' is the absolute water level in the pump's wet well (i.e. From Node), and 'dH' is the water level difference between the (downstream) 'To Node' and (upstream) 'From Node' locations.

If an offset is specified, this will be added to the capacity curve relation.

Also note that one may specify a pump capacity curve with energy consumption (i.e. Capacity Curve QdH & Power).

### 8.1.2 Pump acceleration curve

Pumps may be RTC controlled. For PID-controlled RTC pumps, the acceleration of a pump can be specified as dependent on the actual flow. This pump acceleration curve is then specified as a number of 'dQ, dQ/dt' values.

### 8.1.3 Regulation curves $Q_{max}(H)$ and $Q_{max}(dH)$

The regulation curves  $Q_{max}(H)$  and  $Q_{max}(dH)$  are used in the regulation of the maximum discharge in links. The regulation can either be a maximum discharge as a function of the water level in a user-specified node, or a maximum discharge as a function of the water level difference between two user-specified nodes.

### 8.1.4 QH relation

QH relations can be used for outlets. Using a QH relation in an outlet means that you specify the discharge out of the outlet based on the water level in the outlet.

### 8.1.5 Valve rating curve

A valve is a functional relation between two nodes of a sewer network. The valve rating curve specifies the relationship between the valve opening (%) and resistance (k).



## 8.1.6 Time-Area curve

The Time-Area curve is used in the Time-Area runoff model. A Time-Area curve represents the percentage contributing part of the catchment surface as a function of time.

MIKE+ comes with three default Time-Area curves - TACurve1, TACurve2 and TACurve3 - applicable for rectangular, divergent and convergent catchments, respectively.

One can define other Time-Area curves. Each Time-Area value table must start with a pair of values (0,0) and must end with a pair of values representing the whole catchment contribution. MIKE+ maintains T-A curves in percent (%), and the last pair of values in the table must be (100,100).

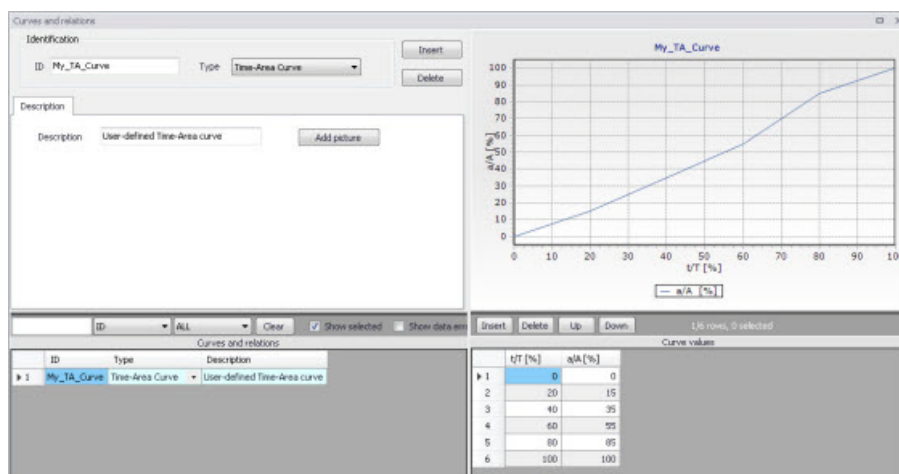

Figure 8.4 Example of user-defined Time-Area curve

## 8.1.7 Removal efficiency

There are three methods available for the removal of sediments in weirs. In one of these methods you specify the relation between discharge towards the weir and the removal efficiency, i.e. the efficiency curve. The removal efficiency is hence a function of  $Q$  and the efficiency (dimensionless 1/1).

## 8.1.8 Curb inlet DQ and QQ relations

Two curve types can be specified for two different types of Curb Inlets:

- DQ Relation (depth-discharge relation specified in the Curb Inlets dialog)
- QQ Relation (Qapproach-Qcapture relation specified in the On Grade Captures editor)

The DQ relation specifies the depth-based capacity curve for a SAG Type Curb Inlet. Values must be monotonously increasing in depth and discharge and starting at (0,0). For depths in excess of the maximum value specified in the last row of the table, the last corresponding discharge value is used.

The QQ relation specifies the relationship between approach flow in the overland flow network ( $Q_{app}$ ) and the captured flow at the connection node for an On Grade Type Curb Inlet ( $Q_{cap}$ ). Values must be monotonously increasing and starting at (0,0). For approach discharges in excess of the maximum value specified in the last row of the table, the last corresponding capture discharge value is used.

### 8.1.9 Capacity curve QdH & Power

If specific power consumption in relation to pump levels is known, it is possible to include this in the model using the 'Capacity Curve QdH & Power' curve type.

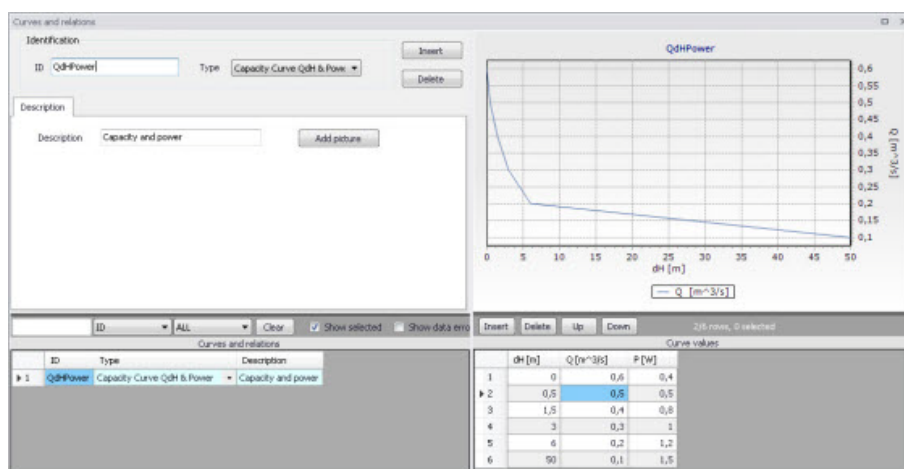

Figure 8.5 Pump capacity curve including power consumption

After the simulation with a 'Capacity Curve QdH & Power' the summary will contain information on the power consumption during the simulation period.

### 8.1.10 Runoff pollutants

This type of table is used in surface water quality (SWQ) boundary conditions as a way to define the Temporal Variation of surface stormwater loads as well as RDI stormwater loads.

The table serves as a lookup table for the boundary condition, where corresponding concentration values are determined based on runoff intensity. The





tabular data set shall contain values for runoff intensity (i.e. the runoff divided by the total catchment area) and corresponding concentrations.

### 8.1.11 Basin geometry

Basin geometries are tabulated area-elevation functions. One specifies values for the parameters  $H$ ,  $A_c$ , and  $A_s$ .

$A_c$  is the cross-section area perpendicular to the main flow direction in the basin, which is used to calculate the velocity.  $A_s$  is the surface area of the basin (used to calculate the volume). Both parameters are specified as functions of the water level,  $H$ , in the basin.

The  $H$ -column for the basin geometry can start at any value, e.g. 0 for interpretation of  $H$  as depth in the basin. MIKE+ associates the first  $H$ -value to the bottom level of the node. This means that the same geometry can be reused in several places in the model.

The maximum level before flooding at a basin is either the highest  $H$  value of the geometry or the ground level. If the top of the basin geometry is below the ground level, the specified basin geometry is extended with additional points to allow for flooding.

The plot for 'Basin geometry' tables shows two types of points:

- Volume points: These are the raw points at levels  $H$  specified in the input table.
- Volume: These are extra points added at regular intervals between levels  $H$  specified in the input table. These extra points help better representing the actual variation of volume between input levels, which is not necessarily linear.

### 8.1.12 Generic control rule

Generic control rule tables are lookup tables defining the functional relation between an actual input value (e.g. sensor reading or difference between sensor readings, etc.) and the set point value (or setting). The tabulated values are linearly interpolated between defined relations.

### 8.1.13 Control rule time series

Control rule time series tables are lookup tables explicitly defining the set-point value (or setting) for particular time periods (i.e. date/time). The tabulated values are linearly interpolated between defined values.

### 8.1.14 Undefined type

The Undefined table type is an extra generic type of table used as a placeholder for potential future functionality.

## 8.2 Two-dimensional Tables

The two-dimensional tables are used for tables defining an output value as a function of two input parameters.

The two-dimensional tables with type 'Time varying control rule' may be used in control rules where a relationship between an input value and a return value (output) changes over time.

Each row represents a specific date and time, for which the return values (output values) are specified in the table in the cells with white background, as a function of the input values specified in the top row with dark background.

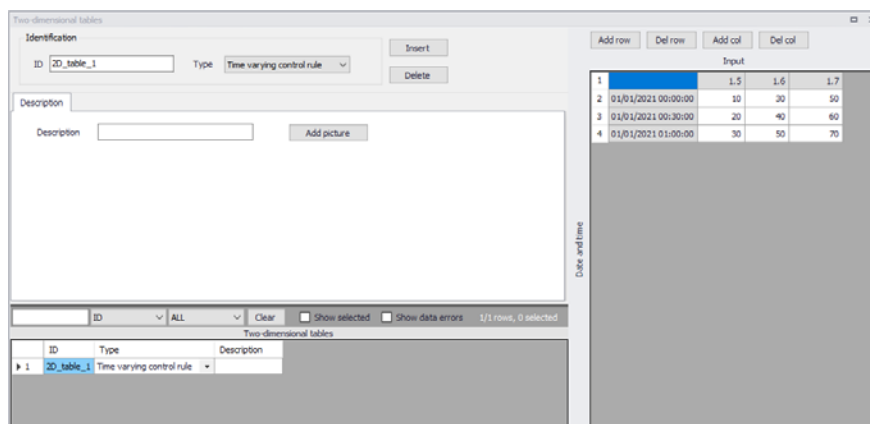

Figure 8.6 Two-dimensional tables Editor

The two-dimensional tables with type 'Tabulated Q' or 'Tabulated h' are used by tabulated structures on river networks, to define the relationships between the discharge in the structure and the upstream and downstream water levels.

The multiple two-dimensional tables with type 'Bridge' are used by bridge structures on river networks, to define the various coefficients that may be required for these structures.

The type of a table can only be selected when it is created, but cannot be changed afterwards.



## 8.3 Materials

In MIKE+, a link is characterised by material, which determines the Manning friction coefficient (Manning M or Manning n), the Colebrook-White coefficient (EQ Roughness), or Hazen-Williams coefficient (H-W Coefficient) for the conduit. It is optional to use either the default roughness values for specific materials or local values.

Specification of the different kind of materials and roughness coefficients is done through the Materials editor (Tables | Materials).

The Materials Editor window displays the following information:

**Identification:** ID: Ceramics

**Initial value / Description:**

- Manning (M): 70 [m<sup>1/3</sup>/s]
- Manning (n): 0.01428571 [s/m<sup>1/3</sup>]
- Equivalent roughness: 0.0025 [m]
- Hazen-Williams coefficient: 110

**Table of Materials:**

ID	Manning (M) [m <sup>1/3</sup> /s]	Manning (n) [s/m <sup>1/3</sup> ]	Equivalent roughness [m]	Hazen-Williams coefficient
1	77	0.01298701	0.001	12
2	70	0.01428571	0.0025	11
3	75	0.01333333	0.0015	12
4	68	0.01470588	0.003	10
5	85	0.01176471	0.0005	14
6	70	0.01428571	0.0025	11
7	65	0.01538462	0.0035	10
8	80	0.0125	0.001	14
9	80	0.0125	0.001	13

Figure 8.7 Materials Editor

MIKE+ has the following pre-defined Material types with friction loss properties:

- Cement Mortar
- Ceramics
- Concrete (Normal)
- Concrete (Rough)
- Concrete (Smooth)
- Iron (cast)
- Iron (wrought)
- Plastic
- Stone



Table 8.2 Overview of the Materials Editor attributes (Table ms\_Material)

Edit field	Description	Used or required by simulations	Field name in datastructure
ID	Material type ID	Yes	MUID
Manning (M)	Manning (M) roughness value	Yes If 'Manning (M)' is used	Manning
Manning (n)	Manning (n) roughness value	Yes If 'Manning (n)' is used	ManningN
Equivalent roughness	Equivalent roughness	Yes If 'Colebrook-White' formulation is used	EQRough
Hazen-Williams coefficient	Hazen-Williams roughness coefficient	Yes If 'Hazen-Williams' is used	HWCoeff
Description	User's descriptive information on the material	Optional	Description

## 8.4 Outlet Head Loss

MIKE+ models outlet head losses at nodes. The general flow equations are valid only for continuous conduits, where the only resistance to flow is bottom and sidewall friction. Hydraulic conditions in nodes, i.e. at manholes and structures, serve as boundary conditions in the computation of flows in conduits. In turn, hydraulic conditions in a node depend on the flows in the inlet and outlet conduits.

These hydraulic conditions, expressed in terms of the energy conservation principle, are calculated as water levels and velocity heads. The calculation is based on the mass continuity and formulation of more or less advanced energy relation between the node and the neighbouring links, including energy losses caused by local flow disturbances at different locations in the node.

The following parameters constitute a definition of head loss calculation option in MIKE+:

### Computation Method

Three different methods are available:



- **Classic.** This is a simplified computational model for energy losses in junctions based on F.A. Engelund's energy loss formulae. The total head loss comprises of node inlet loss and node outlet loss, including losses due to change in flow direction, due to change in elevation, and due to contraction, if relevant.
- **Mean Energy Approach.** This is an alternative solution which fully ignores the energy loss at the inlet. For a flow-through manhole, this means that the energy level in the manhole is set equal as at the downstream end of the inlet pipe. For manholes with multiple inlets, the energy level is calculated as the weighted average of the inlet flows (i.e. large flows contribute most to the energy level). In this formulation, the total loss at the manhole is concentrated computationally at the outlet, and can be fully controlled by the user.
- **No Head Losses.** This option ignores all local losses. Regardless of the shape of the outlets, geometrical set-up of the junction and distribution of flows among inlet and outlet conduits, water levels in the junction and the outlet conduit are set equal as if there is no change of geometry and flow conditions between the junction and outlet conduit. This means that this option should be applied only where there is no change in cross section. Inconsistent results may be generated if inappropriately applied. This option is recommended for an artificial node/junction along a straight section of conduit, where no losses actually occur.

Further details on the various head loss computation methods mentioned above are found in the MIKE 1D Reference Manual.

## Effective Node Area

This parameter is only relevant for the Classic head loss computational method. In all other cases, the default total wetted node area is applied. The following choices are available:

- **Full Node Area.** Calculated as product of diameter and water depth for manholes and read from the basin geometry table ( $A_c$ ) for basins. Typically results in overestimate of local loss in a node.
- **Calculated Effective Area.** The effective area in a manhole is calculated based on an empirical formula (see Section 4.6.2 'Headloss calculation for inflowing water' section in the MIKE 1D Reference Manual). This results in a significantly smaller area than full wetted area and, consequently, with a more realistic flow calculation.
- **Reduced Calculated Effective Area.** The effective area in a manhole is further reduced to 50% of the calculated effective area.

## Loss Coefficient

The available loss coefficient types distinguish three different interpretations of the specified head loss coefficient.



- **Km.** Interprets the specified value as the outlet 'shape' coefficient  $K_m$  (see Equation (4.17) in MIKE 1D Reference Manual).
- **Contraction HLC.** Interprets the specified value as the outlet 'contraction' coefficient  $\zeta_{\text{contr}(j)}$  (see Equation (4.17) in MIKE 1D Reference Manual). This means that the model ignores the geometrical relations between the node and the outlet links (outlet shape), and applies the specified value directly as the  $\zeta_{\text{contr}}$ . The contraction losses in the outlet links are then computed by multiplying the velocity head in the respective link by the  $\zeta_{\text{contr}}$ . The total head loss for an outlet link is computed as a sum of the contraction, direction and elevation loss.
- **Total HLC.** Interprets the specified value as the total outlet head loss. This means that the model completely ignores the geometry of the node/links, and applies the specified value (Total HLC) directly as the  $\zeta_{\text{out}}$ , the same for all outlet links at the node. The total head losses in the outlet links are then computed by multiplying the velocity head in the respective link by the specified  $\zeta_{\text{out}}$ .

Changes to outlet head loss parameter sets used for Nodes are made via the Outlet Head Loss editor (Tables|Outlet Head Loss). Figure 8.8 also lists five pre-defined head loss parameter sets in MIKE+.

ID	Method	Coefficient type	Coefficient	Effect area	
1	Flow-Through Manhole	Classic	Km	0,25	Calculated Eff. Area
2	MOUSE Classic(Engelund)	Classic	Km	0,25	Full Node Area
3	MOUSE Classic(Engelund)_Modified	Classic	Km	0,25	Full Node Area
4	No Cross Section Changes	No Head Losses	Km	0	
5	Weighted Inlet Energy	Mean Energy Approach	Km	0,25	Full Node Area

Figure 8.8 Outlet Head Loss Editor



Table 8.3 Outlet head loss parameter set Editor attributes (Table msm\_LossPar)

Edit field	Description	Used or required by simulations	Field name in datastructure
Head Loss ID	Unique head loss parameter set identifier	Yes	MUID
Method	Dropdown menu to select head loss calculation method for parameter set: - Classic - No Head Losses - Mean Energy Approach	Yes	OutletShapeNo
Effective Node Area	Choice of method for the calculation of wetted area: - Full Node Area - Calculated Eff. Area - Reduced Calculated Eff. Area	Yes If Method = Classic	EffAreaNo
Loss Coefficient [dropdown menu]	Definition of the interpretation of the head loss coefficient: -Km - Contraction HLC - Total HLC	Yes If Method = Classic or Mean Energy Approach	CoeffNo
[Field next to Loss Coefficient dropdown menu]	Value for the loss coefficient	Yes If Method = Classic or Mean Energy Approach	Coeff

## 8.5 On Grade Captures

On Grade Captures tabular data are used as hydraulic properties for On Grade Curb Inlets describing the transfer capacity of connections. The On Grade Captures editor allows the user to group together QQ relations (tabular Curves and Relations data) that comprise a single On Grade Curb Inlet geometry (collective of QQ relations defining the capture rate as a proportion of approach flow). The transfer capacity for an On Grade Curb Inlet is dependent on the approach slope in the overland flow network, and a number of QQ relations can apply for a single curb inlet.

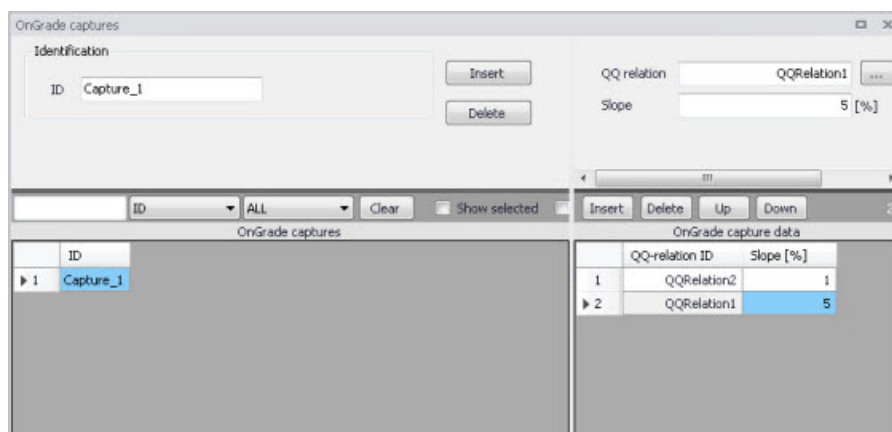

Figure 8.9 On Grade Captures Editor

For calculated or user-defined slopes in the Curb Inlet dialog that are outside the range of slopes specified in the On Grade Captures table, the closest slope curve will be used. For intermediate calculated or user-defined slopes (lying between slope curves in the On Grade Captures table), linear interpolation is applied.

In the case of an On Grade Curb Inlet capacity that is not dependent on slope of the overland flow network, the user needs to define the On Grade Capture with a single QQ relation. *Note: In this case, the calculated or user-defined slope in the Curb Inlet dialog for On Grade Type will be ignored.*





## 9 Control Rules

The MIKE+ Control module features advanced control capabilities for urban drainage, sewer systems and river networks. It can describe various controllable devices and makes the definition of complex operational logic for interdependent regulators fully transparent and time efficient. The following controllable devices can be specified:

- Pump
- Weir
- Gate in rectangular orifice (Blade moves from top to bottom)
- Weir in rectangular orifice (Blade moves the bottom to top)
- Valve
- Culvert
- Gate
- Direct discharge

The devices may be specified as directly controlled or PID-controlled, with control function evaluation based on a global system analysis. Each structure operates under the control logic encapsulated into a set of simple logical rules and control functions.

The MIKE 1D Control module employs an algorithm that reads arbitrary input, not necessarily limited to states of the network itself, and sets the state of the simulation. Network state conditions include measurable and derived hydraulic and water quality variables (e.g. water level, flow, pollutant concentration, level difference), device status (e.g. gate position, pump ON/OFF) and the current control function.

The control functions range from the simplest constants for the operational variables (e.g. constant weir crest setting or constant flow setpoint) to dynamic controlled variables set in a continuous functional relation with any of the measurable variables in the system (e.g. CSO discharge setpoint as a function of flow concentration or a pump START/STOP levels as functions of water level at a strategic location in the system).

### 9.1 Controls in Urban and River Networks

Control rules are active controls and operations of flow regulators based on measured information or target on the network.

Control of structure is feasible where it proves that flexible redistribution of water in space and time contributes to the fulfilment of the specified operational objectives based on economically- and technically-sound solutions.



Accordingly, application of structure regulation to river, drainage and sewer systems may be relevant:

- Where the system has substantial transport, storage or treatment capacity not effectively used under passive system operation;
- Where typical rainfall patterns over the catchment area exhibit high degrees of spatial variability resulting in some parts of the system becoming overloaded whilst others are underutilised;
- Where the urban wastewater system includes treatment processes whose performance is amenable to active, short term control;
- Where the assimilative capacity of the receiving waters is variable over time.

Usually, such structure regulations are implemented as an integral part of a rehabilitation/upgrade scheme also involving significant civil upgrading works to increase the transport, treatment or assimilative capacity of the river / urban network. In such circumstances, the role of structure controls is to optimise the operation of both the new and the existing facilities, thereby maximising the benefit in performance terms. Where the overall objective is to achieve compliance with specified performance targets, structure controls serve to minimise the scale and extent of the necessary works.

## 9.2 Architecture of Real-Time Control Systems

An RTC system includes **sensors/monitors**, which generate measurement values characterising states of the system. To be useful for RTC, the measurements must be available with relatively insignificant time lag (delay). The sensors must be accurate and reliable.

The active control is performed by **regulators** - controllable movable devices (weirs, gates, valves etc.) and pumps. Regulators may take various forms and sizes, and the regulation may be continuous within the functional range, step-wise, or discontinuous (e.g. ON/OFF, OPEN/CLOSED). The regulators may be powered mechanically, hydraulically or pneumatically.

Controllers on the basis of a pre-programmed operational strategy determine the regulator movements (the **control actions**). The operational strategy may consist of two parts: the control action(s) and, if more control actions are specified, the control logic (**conditions**) responsible for the selection of an appropriate control action. A control action establishes a relation between a **control variable** and a **controlled variable**. A controlled variable can be a regulator setting (e.g. gate position, pump START/STOP level) or some of the flow variables (e.g. water level, flow).

In the latter case, the control decisions are derived by evaluating (comparing) the current value of the controlled flow variable and the pre-defined **setpoint** value. The control algorithm is based on the numerical solution of the “contin-



uous control problem” equation and is usually termed as **PID** (Proportional-Integral-Differential) control. The actuation signal for the regulator is generated by a PID controller, which usually appears as part of the operational strategy programmed in a Programmable Logical Controller (**PLC**).

Selection of a controlled variable is, however, subject to limits set by the variable’s “controllability”. Therefore, a controlled variable is usually selected among the flow variables (flow, water level), preferably in the vicinity of the regulator. As a controlled variable becomes more distant from the regulator, it becomes more difficult to control due to time lags, diffusion and uncontrollable interference. Control of relatively distant controlled variables is difficult and often cannot give satisfactory results.

When a regulator setting is used as a controlled variable, the control algorithm is reduced to an explicit functional relation between the control variable and the regulator setting, which controls the system response indirectly. This is much simpler than PID control, but in turn, the control results are in many cases inherently inexact and only a rough flow control can be achieved. This type of control is most suitable for regulators of the ON/OFF (or OPEN/CLOSE) type, while the application to continuously controllable regulators should be carefully considered.

If the operational strategy is based on conditions local to the regulated device (for example the ON/OFF-control of a pump based on the water level in a wet well) it is called **local control**. A PLC receives signals (measurements) from local sensors and sends the control decisions (actuation signals) to the regulators. The usual situation for a sewer system is to have a number of local controllers associated with pumps.

If the operational logic is based on global conditions, it is then called **global control**. In such a situation, a **global controller** is required. A global controller is a computer program that makes the overall system state analysis in real time and provides additional input to the local controllers, which overrides or supplements the local logic with e.g. actuator signals, or by modified setpoint values.

An additional component needed is then a data transmission system to transfer data between sensors, controllers and the global controller. In connection with the global controller function, an RTC system is usually equipped with the data management and storage facilities (databases) and the user interface. This is usually termed as SCADA (Supervisory Control And Data Acquisition) system.

The global control can also be extended to include forecast data in addition to real-time data, which is then called predictive RTC. The most comprehensive way to obtain forecast data is to include a model in the control system. Predictive control brings additional benefits in relatively inert systems, i.e. where the response time of an operational variable is long compared to the change of relevant disturbance (external input or control action).



## 9.3 MIKE+ Control vs. Real Life

Control rules in MIKE+ simulate reactive local and global RTC systems in river, drainage and sewer networks. The software implementation is inherently a conceptualisation of real life, of which the user must be fully aware. Some conceptualisations applied in MIKE+ are listed below.

- The program does not distinguish explicitly between local and global RTC. Per default, all elements of a modelled RTC system are assumed available for global control.
- Sensors are specified as operational devices with definition of sensor type and position in the network. Sensors with multiple functionality must be specified individually.
- When devices (weirs, gates, etc.) are specified as controllable in the MIKE+ interface, a number of Regulation parameters about the behaviour of the structure is required to describe e.g. the allowed change rates for the state of the structure.
- The actual controllers are not specified explicitly as physical devices, but their function (i.e. operational logic as a combination of operational conditions and control actions) is associated with the respective devices.
- MIKE+ controls use sampling and actuation (control loop) frequency identical to the simulation time step.
- Sensor readings are simulated as perfectly accurate and with 100% availability.
- The PID control algorithm is built into the program and is controlled by the PID constants and by factors for weighting the terms of the numerical solution of the control equation.

## 9.4 Sensors

A sensor is a device positioned somewhere in the system providing information on the actual value of a monitored variable.

A sensor can only monitor one variable. If more variables are measured at the same location, a corresponding number of sensors has to be described.



The screenshot shows a software window titled 'Sensors'. It has two tabs: 'General' and 'Description'.  
 In the 'Identification' section at the top, there is a text box for 'ID' containing 'Level\_West', a dropdown for 'Type' set to 'Water level', and a text box for 'WQ component' which is empty. There are 'Insert' and 'Delete' buttons to the right.  
 In the 'General' section, there is a dropdown for 'Location type' set to 'Node' and a text box for 'Node ID' containing 'C14150802'.  
 In the 'Description' section, there is a text box for 'Sensor value's unit' containing 'Unit [m]'.

Figure 9.1 The Sensors Editor showing an example setup for a water level sensor

Table 9.1 Overview of the Sensors editor attributes (Table msm\_RTCSensor)

Edit field	Description	Used or required by simulations	Field name in data structure
ID	Sensor unique identifier	Yes	MUID
Type	Type of parameter measured by the sensor	Yes	TypeNo
WQ Component	Measured water quality component	Yes If Type = Concentration or Mass flux	ComponentID
Location/ Type	Location type	Yes	LocationNo
Location/ ID	Location ID	Yes	_LocationID (prefix varies with location type)
Time Series File	Path to external time series file defining sensor values	Yes If Type = External	TSFileName
Time Series Item	Item name for the selected data series from the time series file	Yes If Type = External	TSItemName



Table 9.1 Overview of the Sensors editor attributes (Table msm\_RTCSensor)

Edit field	Description	Used or required by simulations	Field name in data structure
Expression	Expression defining a user-defined variable	Yes If Type = Variable expression	Expression
Description	Free text description of the sensor	Optional	Description

### Sensor ID

Each sensor needs a unique ID, which can be used to access the sensor information from other dialogs.

### Type

This parameter defines the type of variable measured by the sensor. The options are:

- Level
- Discharge
- Surface Runoff
- Concentration
- Mass Flux
- Weir/Gate Position
- Pump ON/OFF
- Action Active (returns a value TRUE when the selected action is active, and FALSE when it's inactive)
- Action Active Time (returns a TimeSpan, which is the time since it was last activated. It returns zero when the action is not active. It can be turned into hours or seconds using a formula)
- Velocity
- Water depth
- Area (cross sectional / flow area)
- Volume
- Valve Opening
- External (external time series file)
- Variable expression (defines a user-defined variable, e.g. defined as a function of other sensors and mathematical functions).

### WQ Component

The measured water quality component for the 'Concentration' and 'Mass Flux' sensor types.

### Location Type and Location

Depending on the sensor type, various location types are available:

- Node: for this location type, the location is defined with a node ID



- Link: for this location type, the location is defined with a link ID and a chainage
- Structure: for this location type, the location is defined at the location of a selected structure. This location type only applies to Discharge type of sensor.
- Upstream structure: for this location type, the sensor is automatically located at the first calculation point upstream of a structure
- Downstream structure: for this location type, the sensor is automatically located at the first calculation point downstream of a structure
- Reach on link: this type is only available for the Volume type of sensor, and indicates that the volume is to be considered between two chainage values along a link

Define the location type and then specify the corresponding location ID. Note that a 'location' may be only indirectly related to a physical location, such as for 'Action Active' and 'External' sensors.

### Time Series File and Item

For an 'External' sensor type, an external time series file, which will be used for sensor values, must be defined. Select the appropriate time series Item to use when loading the time series file.

### Expression

The expression is used to define an 'Expression variable' sensor. This type of variable is usually a function of other sensors. The primary purpose is to define complex control rules using such variables: instead of defining a complex condition for a control rule, it is possible to define a complex variable and then call it in a simpler condition for the control rule. The variable's value can also be saved in the result file during the simulations, and it is therefore easier to check that the correct behaviour of the regulated structure is modelled, by comparing the applied control strategy with the variable.

The expression defining the mathematical expression of the variable can be typed manually or using the 'Edit' button. This button opens the Expression Editor, which offers a list of available sensors, functions and operators.

Example: An example of a syntax for a variable deriving the energy through a structure may be as provided below:

$$9.81 * [dh] * [Q] * [efficiency]$$

Where [Q] is a sensor returning the discharge value through the structure and [dh] and [efficiency] are other user-defined variables.

Note: The condition must be written with the syntax from C# programming language. Therefore, the few rules below should apply:

- A path to file must be written with double \. For example, if a variable looks up the time series C:\Data\TS.dfs0, the file path in the function must be written C:\\Data\\TS.dfs0.



- The decimal separator must always be a point.

Note: Circular references (i.e. interdependency of variables) are not supported. That is, a first expression variable can depend on a second one, but in this case it is not allowed that this second variable also depends on the first one. If Variable1 is used in the expression defining Variable2, then Variable1 must be defined above Variable2 in the table. The order of the variables is changed using the 'Move up' and 'Move down' buttons.

#### Move up / Move down buttons

The order of the sensors in the table is important only for 'Expression variable' sensors, and only in case one variable is defined as a function of another variable.

#### Unit

The unit is read-only, and is shown for information. It controls in which unit the sensor values are considered in the expressions, for example in the 'Condition' expression of a control rule. The unit is set according to the sensor type. The unit can be changed for each sensor type from the 'Model type' page. Refer to page 117 for more information about units customization.

## 9.5 PID Parameters

This editor is used to define the functions for PID (Proportional Integral Differential) control. PID controls can apply to various controllable parameters, either from collection system structures or from river structures, e.g. weir crest level, pump flow, etc. Independently of the choice of the controlled variable, the PID algorithm adjusts the settings of the regulator according to the current error between the specified setpoint and the actual value of the controlled variable.

A single PID set can be used in multiple actions.



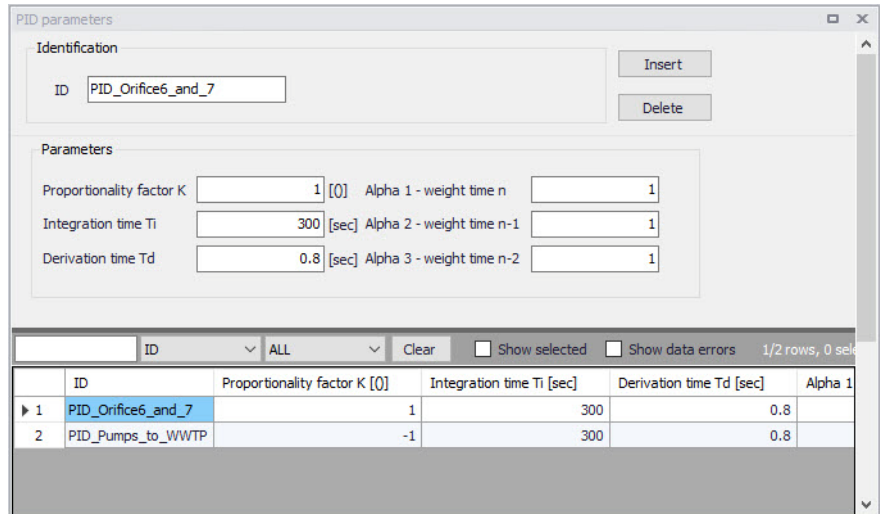

Figure 9.2 The PID Parameters Editor

### ID

Each set of PID settings is identified with a unique ID. This is how the PID parameter set is accessed from other dialogs.

### Proportionality Factor, Integration Time, and Derivation Time

The 3 main parameters for the PID control. These parameters are further discussed in Section 9.5.1 below.

### Alpha-1, Alpha-2 and Alpha-3

Weighting factors for time level n, n-1 and n-2. These parameters are further discussed in Section 9.5.1 below.

## 9.5.1 Calibration of the PID Constants

Tuning of the PID constants (Ti, Td and K) is not a straightforward task. Understanding the theoretical background and the numerical solution of the control equation would be beneficial in this process.

The following values may be used as a guide:

### Typical values of the PID constants and weighting factors

Table 9.2 below shows suggestions for initial values for PID constants.



Table 9.2 Summary of typical values for PID constants and weighing factors

Parameters	Pumps	Gates	Weirs
Ti	300 sec.		
Td	0.8 sec.		
K (Setpoint downstream of device)	1	1	-1
K (Setpoint upstream of device)	-1	-1	1
Alpha-1	1	1	1
Alpha-2	1	0.7	0.7
Alpha-3	1	1	1

NOTE: The sign on the K-factor is very important. If it is wrong it will cause the control function not to work at all since the device will typically move to one of the extreme positions and stay there until the end of the simulation.

Figure 9.3 to Figure 9.5 show examples of how the actual variable (flow or water level) can fluctuate around the setpoint as a consequence of PID constants values. Each figure has three different graphs depending on whether the constant is too high, too low, or adequate.

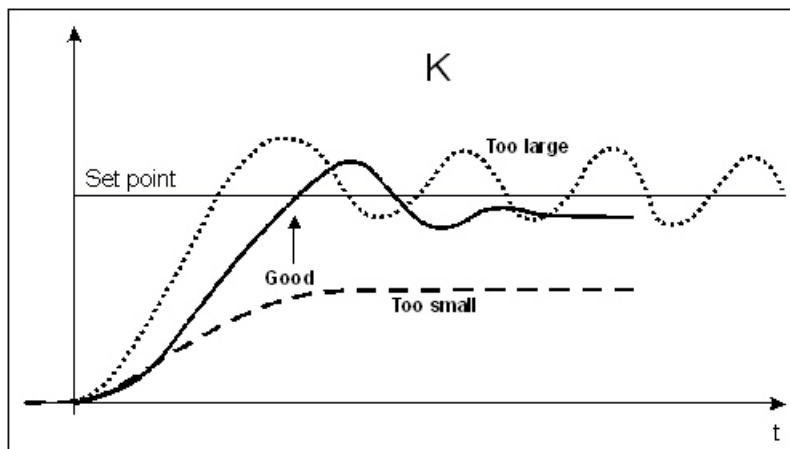

Figure 9.3 Fluctuations around the setpoint depending on the size of the proportionality factor, K

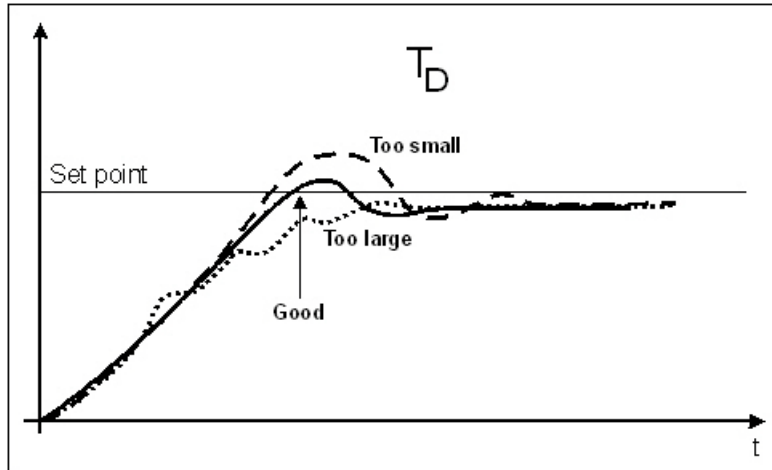

Figure 9.4 Fluctuations around the setpoint depending on the size of the derivation time,  $T_D$

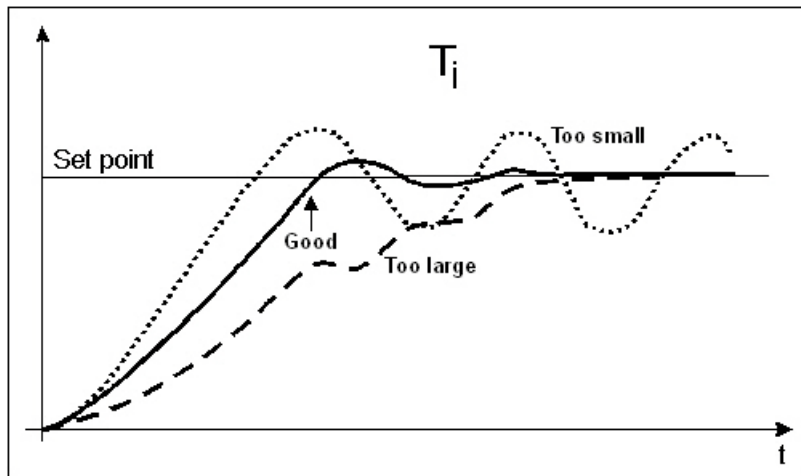

Figure 9.5 Fluctuations around the setpoint depending on the size of the integration time,  $T_i$

## 9.6 Actions

The action to be performed, when the condition associated to a rule is fulfilled, is defined in the Actions editor.



ID	Structure type	Control type	Action	PID input	PID set point	PID parameters
1	Control_Sir40.1_O	Orifice (CS)	Set gate level	Set value		
2	Control_Sir40.2_O	Orifice (CS)	Set gate level	Set value		
3	Control_Sir40.3_O	Orifice (CS)	Set gate level	Set value		
4	Control_Sir40.4_O	Orifice (CS)	Set gate level	Set value		
5	Control_Sir5.1	Orifice (CS)	Set gate level	Set value		
6	Limit_WL_in_PSD_to_WWTP_1	Orifice (CS)	Set gate level	PID control	[WL_PS_to_WWTP] -1.7	PID_Orifice6_and_7
7	Limit_WL_in_PSD_to_WWTP_2	Orifice (CS)	Set gate level	PID control	[WL_PS_to_WWTP] -1.7	PID_Orifice6_and_7

Figure 9.6 The Actions Editor

### Structure Type

This list controls the type of structure to which the action can apply. On a collection system network, actions can apply to:

- Pumps
- Weirs
- Valves
- Orifices.

On a river network, actions can apply to:

- Culverts
- Weirs
- Gates
- Direct discharges
- Dambreaks
- Pumps
- Bridges
- Tabulated structures

### Control Type

This field controls the variables to be regulated on the structure.

The available Control types are:

- For a pump (CS network):



- Set start level
  - Set stop level
  - Set flow
  - Stop pump (taking the pump's deceleration time into account)
  - Shutdown pump (halts the pump immediately)
  - Resume pump (to be used after stopping or shutting down the pump)
- For a weir (CS network):
  - Set weir crest level
- For a valve (CS network):
  - Fully open
  - Close
  - Set valve opening
- For an orifice (CS network):
  - Set weir crest level
  - Set gate level
  - Fully open
  - Close
  - Set gate minimum level
  - Set gate maximum level
- For a culvert (river network):
  - Set flow factor
  - Set flow type
- For a weir (river network):
  - Set weir crest level
  - Set weir coefficient
  - Set flow factor
  - Set flow type
- For a gate (river network):
  - Set gate level
  - Fully open
  - Close
  - Set gate minimum level
  - Set gate maximum level
  - Apply natural flow
  - Set flow factor
- For a direct discharge (river network):
  - Fully open
  - Close
  - Set flow



- Set minimum flow
  - Set maximum flow
  - Apply natural flow
- For a dambreak (river network):
  - Set flow factor
  - Start breach (must be combined with a 'Wait' action)
  - Wait (no operation: to be applied until the breach is started)
  - Set flow type
- For a pump (river network):
  - Set flow
  - Apply natural flow
  - Stop pump
  - Shutdown pump
  - Resume pump
  - Set start level
  - Set stop level
- For a bridge (river network):
  - Set flow factor
  - Set flow type
- For a tabulated structure (river network):
  - Set flow factor
  - Set flow type

When the control type applies to a variable specified in the structure editor, the value from the action will overwrite the value from the structure editor during the simulation. For example, when controlling the start level of a pump, the 'Start level' value specified in the Pumps editor is replaced by the value from the actions, when the pump is controlled.

When the control type is 'Apply natural flow', the structure is ignored and the flow is computed as in a natural channel.



Note: For a pump, it is not allowed to control simultaneously its flow and its Start / Stop levels.

### Action

This controls the type of action which is performed. The following options are available:

- Keep unchanged: the controlled parameter (e.g. the gate position or the flow) remains unchanged, i.e. equal to its previous value.
- Set value: the specified value in the 'Value' field is an absolute value (e.g. level for a gate position or discharge for a flow).



- Set relative change: the specified value is a relative change from the previous state.
- Set value from time series: the time-varying absolute value is specified in a time series file.
- Set value from table: the absolute value is specified in a table, containing the relationship between an input variable and the desired value (output). The table is defined in the 'Curves and relations' editor.
- Set relative change from table: the relative change is specified in a table, containing the relationship between an input variable and the desired value (output). The table is defined in the 'Curves and relations' editor.
- PID control: the value of the controlled parameter is assessed indirectly, by minimizing the deviation from the expected value.
- Apply natural flow: the structure is ignored and the flow is computed as in a natural channel.
- Apply structure flow: the action triggers the use of the regular energy loss calculation in a structure. It is meant to enable the calculation of the flow through the structure, when combined with the 'Apply natural flow' action.

### Value

The absolute value or relative change to be applied. The value can either be a simple numeric value or derived from an expression. The 'Edit' button may be used to specify an expression.

### File name

The path to the time series containing the values to be applied.

### Table ID

The table ID, as specified in the 'Curves and relations' editor, to be used to define the value. The tabular data shall represent the functional relation between the input (e.g. input sensor reading or a combination of two sensors) and the return value. The tabulated values are linearly interpolated between defined values. The selected table may also be selected from the tables listed in the 'Two-dimensional tables' editor, if the table should vary over time. With this type of table, the relationship between the input variable and the return value (output) is a function of time. If the input value obtained during the simulation is smaller than the smallest input value specified in the table, then the column related to the smallest input value is used. If the input value obtained during the simulation is greater than the greatest input value specified in the table, then the column related to the greatest input value is used.

### Table's input

Indicates the variable used as input in the table. The 'Edit' button may be used to select e.g. a sensor.



### Values specified as yearly variation

This may be used to apply the same yearly pattern to multiple years. When selected, values will be interpolated between the first and the last values specified within the year, and between the last and the first values. When unselected, if the time span of the table does not cover the whole simulation period, the first values of the table will be used for earlier dates and times, and the last values of the table will be used for later dates and times. Only available when using a two-dimensional table.

### PID set point source

This controls the type of set point for the PID control. The following options are available:

- Expression: the specified value in the 'PID set point' field is an absolute value defined by an expression
- Time series: the time-varying absolute value of the set point is specified in a time series.
- Table: the absolute value is specified in a table, containing the relationship between an input variable defined by the Table input and the output which is identical to the desired setpoint

### PID input

For a PID action, the Input parameter is the parameter being evaluated against the setpoint (i.e. target) value at the setpoint for the controlled device.

The Expression editor may be used to define the Input. Note that a Double data type is expected from the evaluation of the input expression.

The input may involve two sensors e.g. if the flow is regulated as a function of the difference between two level sensor values.

### PID setpoint

The setpoint value (i.e. target) for a PID control action.

When the 'PID set point source' is set to use an expression, the Expression editor may be used to define the Setpoint (constant value or functional relation). Note that a Double data type is expected from the evaluation of the setpoint expression. It is also expected that the expression of the setpoint returns a result in the same unit as the 'Input'.

When a time series is used as 'PID set point source', it holds the path to the time series file.

When the 'PID set point source' is set to use a table, the field holds the table ID, as specified in the 'Curves and relations' editor. The tabular data shall represent the functional relation between the input (e.g. input sensor reading or a combination of two sensors) and the return value (setpoint or setting). The tabulated values are linearly interpolated between defined values.





### PID parameters

The set of PID parameters used in the PID control. These sets are defined in the PID parameters editor.

### Table's input

Indicates the variable or expression used as input in the table for PID set point source. The 'Edit' button may be used to select e.g. a sensor or specify an expression.

### Set point scale / Scale factor

The set point or time series will be multiplied by this factor. The scale can either be a constant value or an expression. The 'Edit' button may be used to specify an expression.

Figure 9.7 shows an example Action setup that is used for a PID-controlled orifice.

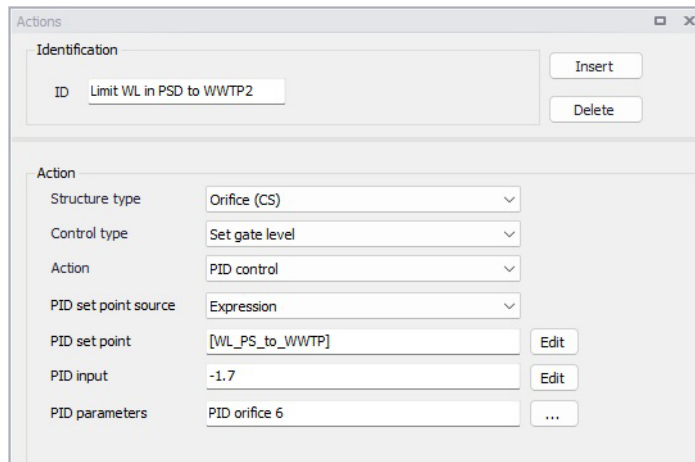

Figure 9.7 Example of PID Action

In this example, the orifice gate level shall be modified for controlling the water level at setpoint location [WL\_PS\_to\_WWTP], where the expected water level is -1.7 m.

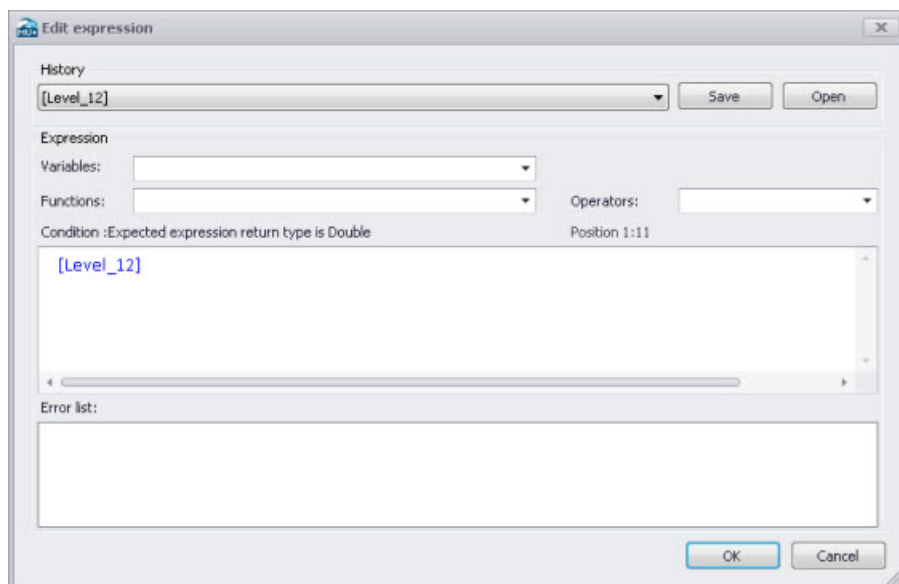

Figure 9.8 Example Input expression in Expression Editor

Initially, one may start with the Variables dropdown menu in the Expression editor when building expressions for Input. The Variables dropdown offers predefined variables, such as Sensors.

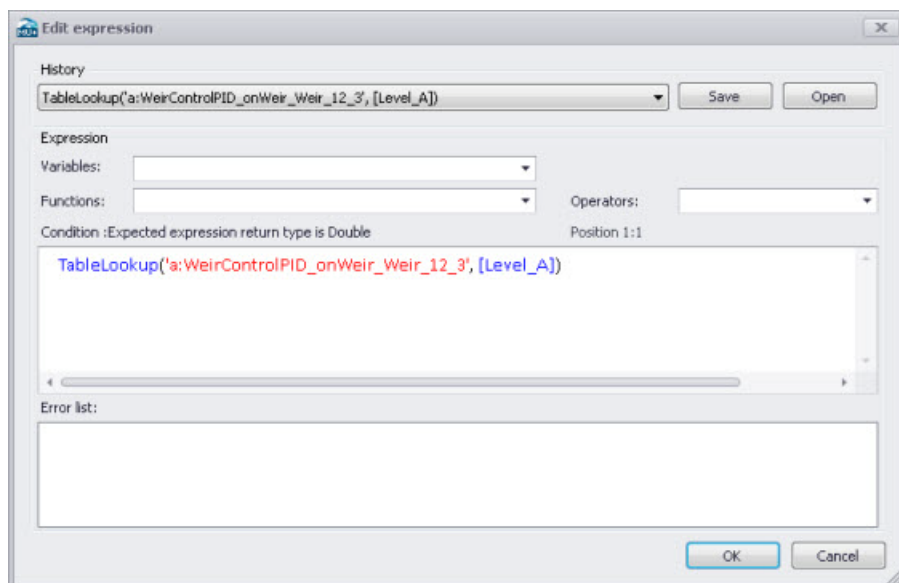

Figure 9.9 Example Setpoint expression in Expression Editor



Functions and Operators may also be used to define more complex expressions for both Input (e.g. difference between 2 sensors) and Setpoint (e.g. TableLookup).



Note: The expressions must be written with the syntax from C# programming language. Therefore, the few rules below should apply:

- An equality check is written ==. For example, the condition for verifying if the simulation time is in August is: Month(SimulationTime()) == 8
- The AND condition is written &&, whereas OR is written ||. This is shown in the 'Operators' drop-down list, but the text AND and OR should not be used in the condition.
- A path to file must be written with double \. For example, if a condition looks up the time series C:\Data\TS.dfs0, the file path in the function must be written C:\\Data\\TS.dfs0.
- The decimal separator must always be a point.

## 9.7 Control Rules

Define controllable devices and the respective control settings on the Control rules editor (Figure 9.10).

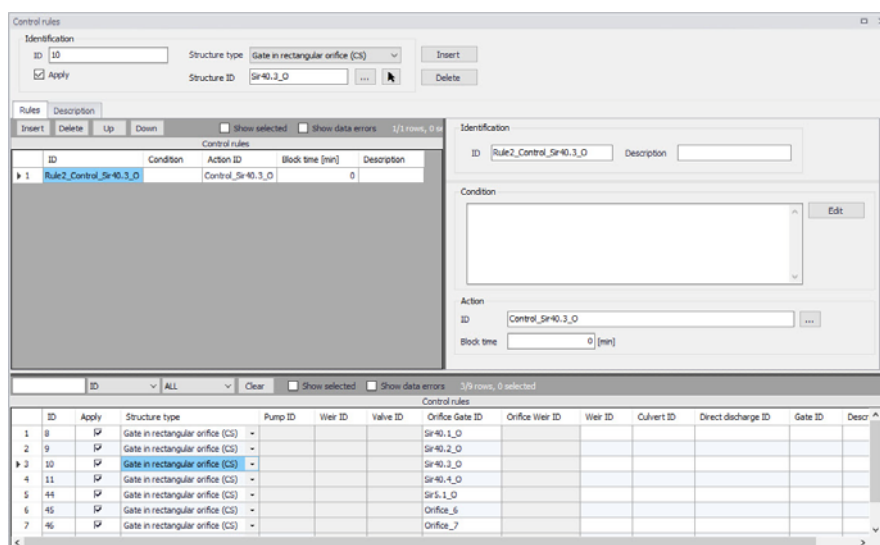

Figure 9.10 The Control rules Editor

The operational control rules for controllable devices are specified in this editor. The control is specified as a set of rules linking logical conditions and control actions. The rules are evaluated sequentially following the rules list sequence.



## 9.7.1 Identification

Specify the ID of the control rule in the Identification group box.

Identification

ID 10 Structure type Gate in rectangular orifice (CS)

Apply Structure ID Sir40.3\_O

Use the 'Insert' button to add a new control rule configuration in the project.

Define the type of controlled device for which to apply the control rule configuration in 'Structure type' list. The types 'Gate in rectangular orifice' and 'Weir in rectangular orifice' apply to orifices on the collection system network. Therefore, a 'Weir in rectangular orifice' type will control an orifice, and not an ordinary weir.

The difference between a 'Gate in rectangular orifice' and 'Weir in rectangular orifice' is that the gate blade edge moves downwards from the top of the orifice (to the bottom), while the weir blade edge moves upwards from the bottom of the orifice.

When the device 'Type' has been selected, the controlled structure ID must be specified

The 'Apply' option controls whether the active control rules configuration is active during the simulation or not.

## 9.7.2 Rules

The various rules applying to the current structure are specified in the Rules tab.

Add and remove rules using the Insert and Delete buttons above the secondary table on the left.

For each rule, an ID and a description may be supplied in the Identification group, and an action must be selected.

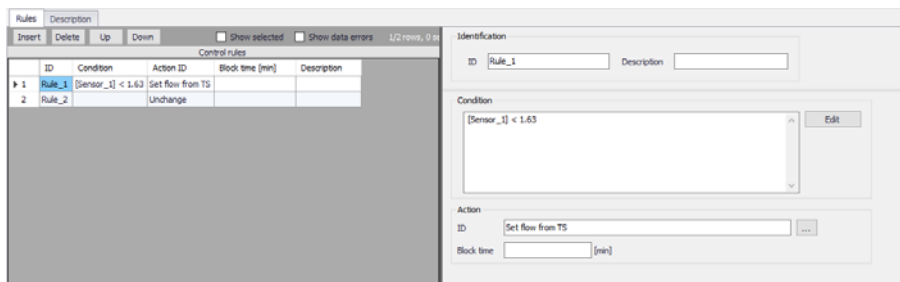

Figure 9.11 Selection of conditions and actions defining the rules

Any number of rules can be specified to control the device. When multiple rules apply, the rules are sequentially evaluated starting from the top, at every time step of the simulation. This means that appropriate sequence of rules is essential for the achievement of the desired control logic.

Use the 'Up' and 'Down' buttons above the secondary grid to modify the order of the Rules. When multiple rules are included, they must be associated to a 'Condition', controlling when a rule applies.

Evaluation of a logical condition belonging to a rule as 'TRUE', leads to the selection of the associated action. If a logical condition is 'FALSE', the evaluation proceeds to the next rule on the list.

If no logical condition is specified, the rule is unconditionally evaluated as 'TRUE'. This implies that the last rule in the sequence must not include any logical conditions in order to ensure a selection of a 'Default' control action if all previous specified conditions are found 'FALSE'.

### Condition

A logical condition demarcates the boundaries of a certain operational situation in the controlled system. This frame consists of an arbitrary number of independent logical tests on the various operational variables, where the relation of the actual value (or state) of the variable (provided by a sensor) is tested against the specified threshold (limit) value (or state). The individual tests are evaluated as TRUE or FALSE, with the outcome depending on the actual variable value (or state), the threshold and the specified operator.

A condition is specified as a mathematical expression in the Condition input box in the editor (Figure 9.12).



Figure 9.12 The Condition input box in the Rules Tab



The implementation of mathematical expressions in MIKE+ is very general, supporting a comprehensive set of mathematical functions and operators. Click on the Edit button to the right of the Condition input box to launch the Expression editor.

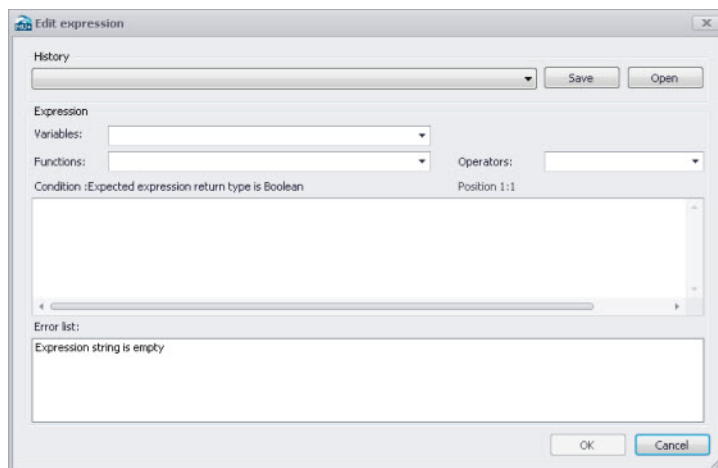

Figure 9.13 The Expression Editor

Mathematical expressions are formulas or expressions trees. The formulas support the standard mathematical functions like sine, cosine, abs, power etc. On top of these standard mathematical functions, a number of specific MIKE 1D engine control functions are available.

Note that a Boolean data type (i.e. TRUE, FALSE) is expected from the evaluation of the expression for Conditions.



Note: The condition must be written with the syntax from C# programming language. Therefore, the few rules below should apply:

- An equality check is written ==. For example, the condition for verifying if the simulation time is in August is: `Month(SimulationTime()) == 8`
- The AND condition is written &&, whereas OR is written ||. This is shown in the 'Operators' drop-down list, but the text AND and OR should not be used in the condition.
- A path to file must be written with double \. For example, if a condition looks up the time series C:\Data\TS.dfs0, the file path in the function must be written C:\\Data\\TS.dfs0.
- The decimal separator must always be a point.

### Action ID

The corresponding Action for a given Condition. Options are taken from the Actions editor. The choice of the controllable device determines relevant control actions.



### Block Time

The Block Time ensures that a certain rule is applied for a minimum period. This means that the system is locked to a certain rule in a period equal to the block time after it is activated, even if the condition is no longer TRUE.

Some notes when specifying rules are:

- All control actions used to control a specific device must be of the same function type - corresponding to the specified device Type and Control Type.
- For PID control, all control actions must refer to the same setpoint sensor (i.e. Input). Changing the setpoint sensor during simulation is not allowed.

### PID Settings

When starting a simulation, the system checks if these conditions are fulfilled and in the case of any violation, the simulation will not start.

## 9.7.3 Description

One may include a description of the control rules configuration in the Description tab of the editor. An image file (e.g. of the controlled device) may also be added using the 'Add picture' button.



Figure 9.14 The Description Tab in the Control rules Editor

## 9.7.4 Difference between weir and weir in orifice

It is possible to define weirs in two different ways. One way is through the 'Weir' dialog, either on a collection system or on a river network, which we will refer to as an 'ordinary weir'. The second way is to use the combination of an orifice and the controllable device type 'Weir in rectangular orifice'.

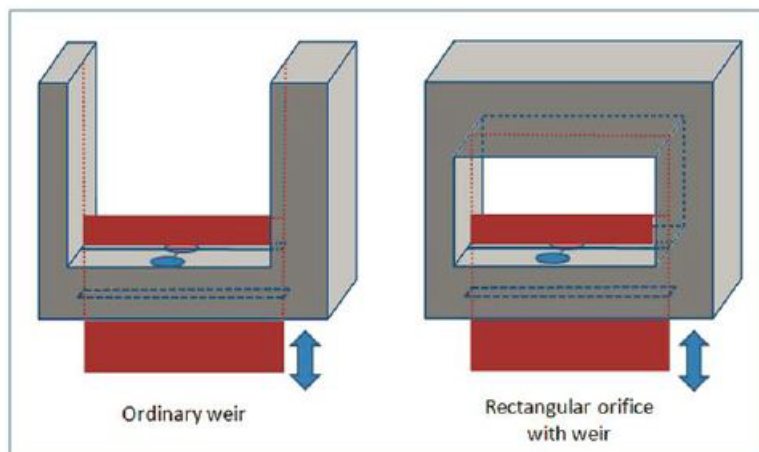

Figure 9.15 Difference between ordinary weir and a weir in rectangular orifice

The main difference is that the 'Weir in rectangular orifice' can close the orifice completely while the ordinary weir is always open upwards. It has no ceiling and in principle the flow can always pass over the weir if the water level is higher than the weir crest level.

For the 'Weir in rectangular orifice', once the weir fully closes the orifice then no flow will pass the weir even if the water level is above the crest level.





## 9.8 Control Rules Computations

A simulation with control rules is started from the usual Simulation Setup editor (Simulation Specifications | Simulation Setup).

Control rules computations are performed if the 'Control rules' module is active on the 'Model type' editor (General Settings | Model type) (Figure 9.16.).

The screenshot shows the 'Model type' editor interface. It is divided into several sections:

- Model type:** A dropdown menu is set to 'Rivers, collection system and overland flows'.
- Unit:** A dropdown menu is set to 'MJ\_CS\_SI' with an 'Edit' button next to it.
- Features:** A list of features with checkboxes:
  - Catchments
  - Collection system network
  - River network
  - 2D Overland
- Couplings to other products:** A list of coupling options:
  - Coupling to MIKE HYDRO River
  - Coupling to MIKE 21 or MIKE 3 Flow Model FM
- Special analyses:** A list of special analyses:
  - Pump emergency storage estimation
- Modules:** A list of modules with checkboxes:
  - Rainfall-Runoff (RR)
  - Hydrodynamic (HD)
    - Control rules
    - Long term statistics (LTS)
  - Transport (AD, SWQ)
    - Water quality (MIKE ECO Lab)
  - Sediment transport (ST)

Figure 9.16 Activate the Control rules module on the Model type Editor





## 10 Water Quality

MIKE+ has several modules for the simulation of water quality for catchment surfaces, sewer systems, and river networks.

MIKE+ can model complex water quality and pollutant transport mechanisms using Stormwater Runoff Quality (SWQ), Advection-Dispersion (AD), and the MIKE ECO Lab engine to solve Biological Processes equations. The MIKE ECO Lab framework offers versatile and flexible options for WQ-modelling. Water Quality simulations can be performed using either standard, predefined MIKE ECO Lab templates or user-defined templates with tailored Water Quality models.

### 10.1 Advection-Dispersion (AD)

Advection-Dispersion (AD) simulates the transport of dissolved substances and suspended fine sediments in the network. Conservative materials as well as those that are subject to a linear decay can be simulated. The computed flow discharges, water levels, and cross-sectional flow areas are used in the AD computation. The solution of the advection-dispersion equation is obtained using an implicit, finite-difference scheme which has negligible numerical dispersion. Concentration profiles with very steep fronts can be accurately modelled. The computed results can be displayed as longitudinal concentration profiles and pollutants graphs, which could be used at the inflow to a sewage treatment plant or an overflow structure. The AD can be linked to Long Term Statistics modelling to provide long-term simulation of pollutant transport.

The option to simulate water age and blend in percentages between two sources can be done with the AD module.

The Advection-Dispersion model can be used to calculate transport of dissolved or suspended substances, age of water, blend in percent between two sources, and for modelling of water temperature variation within the network. The model is based on the one-dimensional transport equations for dissolved materials. The equations reflect two transport mechanisms: the advective transport with the mean flow velocity, and the dispersive transport due to concentration gradients in the water. The transport equations are solved by use of an implicit finite difference scheme, which is fully time and space centred, in order to minimize the numerical dispersion. The main assumptions of the model are:

- The considered substance is completely mixed over the cross-sections. This implies that a source term is considered to mix instantaneously over the cross-section.
- The substance is conservative or subject to a first order reaction (linear decay).

- Fick's diffusion law can be applied, i.e. the dispersive transport is proportional to the concentration gradient.

Special considerations have been given to the transport at manholes and other structures.

The Advection-Dispersion model requires two types of data: time series of concentrations at the model boundaries and data for full definition of the components to be modelled, e.g. initial concentrations, dispersion coefficients and decay rates.

## WQ Components

Each of the water quality (WQ) components (substances) to be included in Advection-Dispersion computations must be specified in this section shown in the WQ Components dialog. Naming of component is absolutely flexible, and no 'reserved' or 'standard' component names are prescribed.

ID	Type	Unit	Description
1	Component_1	Microorganisms	M/100 ml
2	Component_2	Pollutant	mg/l
3	Temp.	Temperature	deg C

Figure 10.1 Define water quality components in the WQ Components editor

The specified WQ components can be declared as 'Pollutant', 'Microorganisms', 'Temperature', 'pH', 'Salinity', 'Water Age', 'Water Blend', 'Other' or 'Fixed matter'. This categorization is used for handling of units: each component type has its own list of possible units.

When working with a water quality model using MIKE ECO Lab, each MIKE ECO Lab state variable is associated to a WQ component from this 'WQ component' editor, and the biological processes are controlled by properties defined in the MIKE ECO Lab editors. The 'Fixed matter' type of WQ component is a special type which is relevant for this MIKE ECO Lab models, and is



used to describe e.g. components deposited at the bottom and not moving with water.

An optional description of the component can also be specified.

Advection-Dispersion initial conditions for the WQ components can be specified in the AD Initial Conditions editor. Also see Chapter 6.2 AD Initial Conditions (p. 292). Advection-Dispersion boundary conditions for the WQ components can be specified in the 'WQ boundary properties' editor. Also see Chapter 7.4 Water Quality Boundary Condition Properties (p. 316) for more description. If not specified otherwise, AD initial conditions and boundary conditions are assumed to be equal to 0.

## Decay

For each WQ component a decay coefficient may be specified. The decay coefficient cannot be given for water age and water blend types. A decay set to 0 describes a conservative component, whereas a positive decay describes a non-conservative component. For a non-conservative component, the concentration is assumed to decay according to the first order expression:

$$\frac{dC}{dt} = KC \quad (10.1)$$

$K$  = the decay coefficient ( $\text{h}^{-1}$ )

$C$  = the concentration

The decay constant (Decay) is defined as a uniform decay over the entire model for each component.

The decay cannot apply for water age and water blend types. The decay is also not relevant for WQ components associated to a MIKE ECO Lab state variable, for which the decay will be simulated as part of the biological processes modelling.



ID	Type	List ID	Link ID	Start chainage [m]	End chainage [m]	WQ component	Decay [h]
1	Local_1	Entire link	C15156101.2	0	87.8	Component_2	0.45

Figure 10.2 Define components' decay in the Decay editor

The decay value can be specified either globally using a default value, or locally in parts of the networks (CS and River). The default value will be used at all locations except for locations where local values have been specified. These local values 'overrule' the global specification.

When a local value is located with a list, the specified local decay value applies to all rivers and pipes included in the selected list.

## AD Dispersion

The dispersion coefficient is specified as a function of the flow velocity. The function is given as:

$$D = au^b \quad (10.2)$$

where:

$D$  = the dispersion coefficient (m<sup>2</sup>/s),

$a$  = the dispersion factor,

$u$  = the flow velocity (m/s),

$b$  = a dimensionless exponent.

If the exponent is set to zero, then the dispersion coefficient is constant and independent of the flow velocity. The unit for the dispersion factor will then be m<sup>2</sup>/s. If the exponent is 1, i.e. the dispersion coefficient is a linear function of the flow velocity, then the unit of the dispersion factor will be meter, and the



dispersion factor will in this case be equal to what is generally termed the dispersivity. It is possible to specify values of the minimum and the maximum dispersion coefficients in order to limit the range of the dispersion coefficient calculated during the simulation.

The screenshot shows the 'AD Dispersion' editor window. It is divided into three main sections: 'Global AD dispersion', 'Identification', and 'Local parameters'. Below these is a table view.

**Global AD dispersion:**

- Dispersion factor: 0.1
- Exponent: 1
- Minimum dispersion coefficient: 0.25 [m<sup>2</sup>/s]
- Maximum dispersion coefficient: 0.3 [m<sup>2</sup>/s]

**Identification:**

- ID: Local\_Dispersion\_1
- Radio buttons:  Entire link,  Link chainage,  List
- Link ID: L1
- Chainage start/end: [m]

**Local parameters:**

- Dispersion factor: 0.35
- Exponent: 1
- Minimum dispersion coefficient: 0.2 [m<sup>2</sup>/s]
- Maximum dispersion coefficient: 1.5 [m<sup>2</sup>/s]

**Table View:**

ID	Connection type	Node List File	Link ID	Start chainage [m]	End chainage [m]	Dispersion factor	Exponent
1	Local_Dispersion_1	Entire link	L1			0.35	

Figure 10.3 Define global and local network model dispersion parameters in the AD Dispersion editor.

The dispersion coefficient can be given either globally, or locally in parts of the networks (CS and River).

The global description will be used at all locations except for locations where local conditions have been specified.

The locally specified dispersion coefficients 'override' the global specification.

## 10.2 Water Quality with MIKE ECO Lab

Biological processes can be modelled through MIKE ECO Lab. It simulates the reaction processes in multi-compound systems, including degradation of organic matter, bacterial fate, exchange of oxygen with the atmosphere and oxygen demand from eroded sediments. This allows realistic analysis of complex phenomena related to water quality.

Biological processes can e.g. include diurnal variation of foul flow discharges and user-specified concentrations of foul flow components. The sediment types included in the interaction with biological processes are foul flow organic sediments, fine and coarse mineral in-pipe sediments originating



from catchment runoff, potholes, and stilling basins. Biological processes can account for:

- Decay of BOD/COD in biofilm and water phase
- Hydrolysis of suspended matter
- Growth of suspended biomass
- Oxygen consumption from decay of BOD/COD, biofilm, and erosion of sediment
- Re-aeration
- Bacterial fate
- Interaction with sediments for nutrients and metals

Hydrodynamic and advection-dispersion (transport) simulations can be coupled with MIKE ECO Lab for efficient and versatile simulation of water quality processes. This option offers practically an unlimited range of processes to be simulated, as long as these can be described by a consistent model. MIKE ECO Lab in MIKE+ is supported by a set of MIKE ECO Lab editors:

- MIKE ECO Lab Templates
- MIKE ECO Lab State Variables
- MIKE ECO Lab Forcings
- MIKE ECO Lab Constants

MIKE ECO Lab and these four editors are used to model the biological processes. Each MIKE ECO Lab state variable must be associated to an Advection-Dispersion component (from the 'WQ components' editor), and therefore the initial conditions and boundary conditions for the state variables are defined by initial conditions and boundary conditions of these WQ components.

### 10.2.1 Notes on MIKE ECO Lab

MIKE ECO Lab is a numerical lab for Ecological Modelling. It is a highly flexible and open framework for the formulation of water quality models. It is an open and generic tool for customising Aquatic Ecosystem models to describe water quality, eutrophication, heavy metals, and ecology. The module can describe dissolved substances, particulate matter of dead or living material, living biological organisms and other components (all referred to as state variables in this context).

The module is mostly used for modelling water quality as part of an Environmental Impact Assessment (EIA) of different human activities, but the tool is also applied in aquaculture for e.g. optimizing the production of fish, sea grasses, and mussels. Another use is in online forecasts of water quality.





## Templates

MIKE ECO Lab uses template files (\*.ecolab file) where water quality models are transparently defined. MIKE ECO Lab template files are customized collections of equations and parameters required for a specific type of Water Quality simulation.

The user may use a predefined MIKE ECO Lab Template installed with the software or may choose to develop their own. The MIKE+ installation includes some pre-defined water quality templates that can be applied “as is” or adjusted to conform to specific project requirements. A MIKE ECO Lab template is an ASCII file which can be accessed and edited through the MIKE ECO Lab editor.



**Note:** It is necessary to install MIKE Zero in order to edit a template file in the MIKE ECO Lab editor.

Please consult the MIKE Zero ECO Lab documentation on how to create or modify model templates, i.e. how to work with the MIKE ECO Lab editor.

A simulation job with the coupled HD/AD and MIKE ECO Lab model is set up and launched from within MIKE+ in the usual way. Also see Chapter 10.2.6 Running MIKE ECO Lab Simulations (p. 387).

## Integration Methods

Water quality calculations are based on predefined MIKE ECO Lab templates which contain models defined by a number of coupled differential equations solved through numerical integration and interactions between each equation.

Several Integration Methods are available for solving the coupled ordinary differential equations defined in the MIKE ECO Lab file. These options are offered in the Simulation Setup editor in MIKE+. See Chapter 10.2.6 Running MIKE ECO Lab Simulations (p. 387).

Three integration routines (solution methods) are available (please consult the MIKE ECO Lab Reference Manual for details on the methods for solving the coupled linear differential equations in the MIKE ECO Lab framework):

- **Euler:** Euler or Linear Solution  
A very simple numerical solution method for solving ordinary differential equations.
- **RK4:** Fourth order Runge-Kutta.  
A classical numerical solution method for solving ordinary differential equations. It has normally higher accuracy than the Euler method but requires longer simulation times. The fourth order Runge Kutta method requires four evaluations of equations per time step.



- **RKQC:** Fifth order Runge-Kutta with Quality Control  
A numerical solution method for solving ordinary differential equations. The accuracy is evaluated and the time step is adjusted if results are not accurate enough. The method requires 6 evaluations at each time step to take a so-called Cash-Karp Runge Kutta step and the error is estimated as the difference between a Runge Kutta fourth order solution and the Runge Kutta fifth order solution.

The accuracy (and the computing time) varies for the three integration routines.

The most accurate result will be calculated when using RKQC. However, in some cases the same results can be obtained using less computational time with the less advanced options: RK4 or EULER.

In general, it is recommended to use the RKQC routine. RK4 and EULER methods are generally only applied during the set-up and initial calibration phase of a project. If the RK4 or the EULER routines are used, it is strongly recommended to run an additional simulation with the RKQC routine and compare the two results (RKQC versus RK4/ EULER) before making any conclusions based on the model.

In the case of a very dynamic model system with steep concentration gradients in one or more of the components, integration may not be possible when using the RKQC routine, and an error message will appear. Reducing the time step will help in most cases, but sometimes the gradients are so steep, that they cannot be solved accurately. The Quality Control of RKQC ensures that all components are calculated within an accuracy of 1 µg/l. Using the second best routine (RK4), where no Quality Control is included, the steep gradients can be solved in a relatively accurate way and RK4 is therefore recommended when integration is impossible with the RKQC routine.

## 10.2.2 MIKE ECO Lab Templates

A MIKE ECO Lab template, describing the water quality processes, must be included in the project. Multiple templates can be used, if they apply to different spatial locations on the network. Templates are selected via the MIKE ECO Lab Templates editor (Figure 10.4).

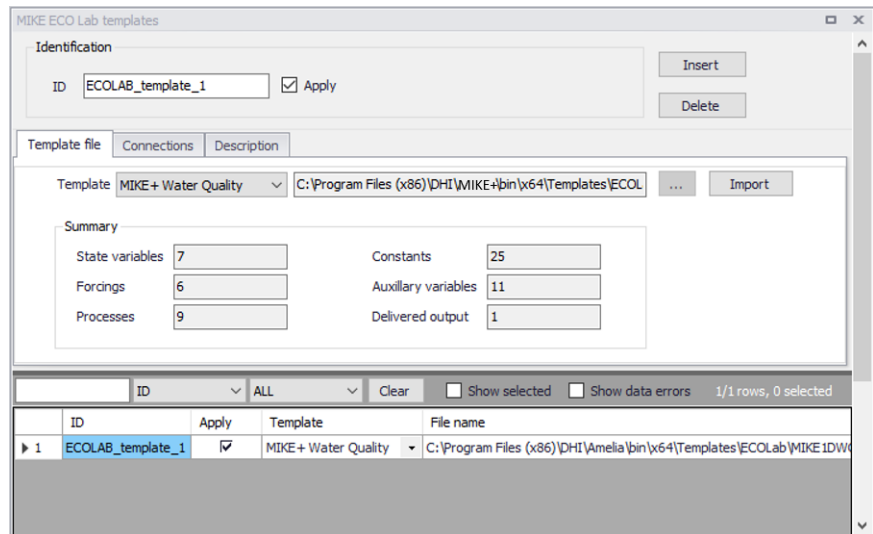

Figure 10.4 The MIKE ECO Lab Templates editor in MIKE+

For coupled simulations, coupling a 1D network to the 2D overland model, it is therefore possible to include one or more templates to model water quality in the network, and another template to describe water quality in the 2D domain.

A template is included in the simulation only if its 'Apply' check box is ticked, and is ignored otherwise.

## Template File

Predefined MIKE ECO Lab templates are included in the MIKE+ installation located in the folder: 'C:\Program Files (x86)\DHI\MIKE+\<Version>\Templates\ECOLab'.

Point to the MIKE ECO Lab template file in the Template File tab page of the editor:

- **Template:** Define the MIKE ECO Lab template to which to connect using the drop-down list (or the ellipsis button for custom templates).
- **Import:** Use the Import button to read and import the contents of the template file (state variables, forcings and constants) into the MIKE+ project and editors. Pressing the Import button after the template has already been loaded (imported) will reload the template and reset all state variables, forcings and constants to default settings.
- **Summary:** Displays general information on the contents of the MIKE ECO Lab template file, such as the number of State variables, Forcings, Processes, Constants, Auxiliary variables, and Delivered output defined in the template.

## Connections

Define for which model parts the loaded MIKE ECO Lab template is applied:

- **Global network:** The template is used over the whole network model (River and CS)
- **Nodes:** The template is used for CS network nodes. It may be in All nodes, a List of nodes, or Individual nodes selected from a list accessed via the ellipsis button, or interactively from the Map using the arrow button.
- **Links:** The template is used for links (i.e. River branches and/or CS pipes and canals). It may be in All links, a List of links, or Individual links selected from a list accessed via the ellipsis button, or interactively from the Map using the arrow button.
- **2D overland:** The template is used for the entire 2D domain as part of a 2D overland simulation. Only one template can apply at a time for a 2D overland simulation.

Figure 10.5 The Connections tab page in the MIKE ECO Lab Templates editor

## Description

Add a free text description for a MIKE ECO Lab template on the Description tab page of the MIKE ECO Lab Templates editor.

### 10.2.3 MIKE ECO Lab State Variables

The MIKE ECO Lab State Variables editor is used for coupling MIKE+ WQ components to MIKE ECO Lab state variables and for possible reconciliation of differences in units used in MIKE+ and MIKE ECO Lab, respectively.

- **ID:** State variable identifier in MIKE+.
- **MIKE ECO Lab template:** MIKE+ ID for the template to which the state variable belongs.
- **State Variable:** State variable identifier in MIKE ECO Lab template file.
- **WQ Component:** MIKE+ WQ component coupled to the MIKE ECO Lab state variable.



- **Conversion Factor:** Conversion factor for possible units conversion between MIKE+ and MIKE ECO Lab
- **Description:** Add a free text description for a state variable via the Description tab page of the editor.

In the MIKE+ WQ Components editor, there must be one component defined for every MIKE ECO Lab state variable defined in the MIKE ECO Lab template. This means that all MIKE ECO Lab state variables are subject to both AD transport mechanisms and MIKE ECO Lab transformations.

For a **State Variable**, the associated **WQ Component** must be selected by the user. These WQ components must represent the same constituents as those in the MIKE ECO Lab template, but their names can be freely defined.

For coupled models, coupling a 1D network to the 2D overland model, different templates have to be used for the 1D network and for the 2D domain. When state variables from the different templates describe the same component, they must be associated to the same WQ component in order to be coupled during the simulation

The specified initial conditions and boundary conditions for the WQ components will therefore control the initial and boundary conditions of the state variables.

ID	MIKE ECO Lab template	State variable	WQ component	Conversion factor
1	ECOLAB_template_1	Temperature	Temp.	
2	ECOLAB_template_1	BOD_susp	Component_3	
3	ECOLAB_template_1	BOD_dis	Component_2	
4	ECOLAB_template_1	DO	Component_1	
5	ECOLAB_template_1	ColiF	Component_6	
6	ECOLAB_template_1	ColiT	Component_7	
7	ECOLAB_template_1	Strep	Component_8	

Figure 10.6 MIKE ECO Lab State Variables



The import operation described in the MIKE ECO Lab Templates editor will automatically create the required entries in the MIKE ECO Lab State Variables editor. The user must then couple each of these MIKE ECO Lab state variables to the relevant WQ component. Select the appropriate component from the WQ Component dropdown list, which is populated by components defined in the WQ Components editor.

The **Conversion Factor** (default value 1, i.e. no conversion) may be set different from 1.0 if the units for the AD components and MIKE ECO Lab state variables are different.



**Note:** The active fields in the editor are only used for coupling the MIKE+ WQ components with MIKE ECO Lab state variables, and for specifying a conversion factor. Edits to the state variables properties, if needed, shall instead be done in the MIKE ECO Lab template file.



**Note:** If multiple templates contain state variables with the same name, then these variables will be shared between the templates during the simulation, i.e. they will have the same state in all templates.

#### 10.2.4 MIKE ECO Lab Forcings

Forcings are external variables which affect some of the processes on the state variables. They are automatically listed in this editor when the MIKE ECO Lab template is imported, from the 'MIKE ECO Lab templates' editor.

Forcings are “Built-In” or “User-Defined”, depending on the forcing definition in the MIKE ECO Lab template. “Built-in” means that forcings are provided by the hydraulic model through coupling with MIKE ECO Lab. “User Defined” forcings must be provided by the user, and can be either constant values (constant in time and domain), varying in time or varying in domain and time (the latter option is only enabled when the forcing is defined as varying horizontally in the MIKE ECO Lab template).



ID	MIKE ECO Lab template	Forcing	TS type	Value	File name	Item ID	File name	Item ID	Description
1	ECOLAB_template_1	u	Built-in	0,2					u, current speed
2	ECOLAB_template_1	dm	Built-in	8					dm, mean depth
3	ECOLAB_template_1	slope	Built-in	0					Slope of the sewer
4	ECOLAB_template_1	volume	Built-in	200000					Volume
5	ECOLAB_template_1	ABiofilm	Built-in	100000					Biofilm area, area in pipe cov
6	ECOLAB_template_1	SED_Eroded	Constant	1500					Amount of eroded sediment

Figure 10.7 MIKE ECO Lab Forcings editor

The editor is used for setting the user-defined forcings associated with the loaded MIKE ECO Lab templates:

- **ID:** Forcing identifier in MIKE+.
- **MIKE ECO Lab template:** MIKE+ ID for the template to which the forcing belongs.
- **Forcing:** Forcing identifier in MIKE ECO Lab template.
- **Value:** Constant value for the forcing.
- **File Name:** Path/file name for the \*.DFS0 time series file containing forcing time series data, or for the 2D data file when the forcing is varying in domain and time.
- **Item:** Data item selected in the file.
- **Description:** Free text description for the forcing defined via the Description tab page.

Built-In forcings are also imported into MIKE+, but don't need any configuration.



**Note** that the active fields in the editor are only those for specifying forcing constant values or input files. The remaining fields are read-only.



**Note** that for templates connected to the 1D network, some forcings may be defined as built-in in the template but appear as user-defined in MIKE+, in case the corresponding variable does not exist in the model setup. That is especially the case for Temperature and Salinity forcings. In order for them to actually work as a built-in forcing, it is necessary to include a WQ component with the corresponding type (temperature or salinity).



## 10.2.5 MIKE ECO Lab Constants

Constants are values which are fixed in time and affect some of the processes on the state variables. They are automatically listed in this editor when the MIKE ECO Lab template is imported, from the 'MIKE ECO Lab templates' editor.

This editor is used for setting the values of the constants used in the MIKE ECO Lab model, typically during model calibration:

- **ID:** Unique MIKE ECO Lab constant identifier in MIKE+.
- **MIKE ECO Lab template:** MIKE+ ID for the template to which the constant belongs.
- **Constant ID:** Constant identifier in MIKE ECO Lab template.
- **Default / uniform value:** Value for the constant, when it's defined as uniform
- **File name:** Path and file name for the 2D data file containing the constant values, when the constant is defined as varying in domain (only available when the MIKE ECO Lab template is connected to the 2D overland model).
- **Item:** Data item selected in the file.
- **Local values:** From the 'Local values' tab, it is possible to apply local values on the 1D network, which will override the default value. For MIKE ECO Lab templates connected to the 2D overland model, use the option 'Varying in domain' instead. Multiple local values can be defined for the same constant, with the following settings:
  - Interpolate this constant between local values: If this option is selected, local values for the same constant will be interpolated in space when they are defined on the same river or pipe. If not selected, values will be interpreted as local values valid only for the specified chainage.
  - Location: each local value is specified either for a specific node or storage (respectively from the CS network and the river network), an entire link (river or pipe), a point on a link (at a single chainage), a reach on a link (defined from a start chainage to an end chainage), or finally using a list. When using a list, the local value is applied to all nodes, storages, rivers and pipes in this list.
  - Local value: local value for the constant.
- **Description:** Free text description for the constant defined in the Description tab page of the editor.





Figure 10.8 MIKE ECO Lab Constants editor in MIKE+

## 10.2.6 Running MIKE ECO Lab Simulations

To run a MIKE ECO Lab simulation, the wanted MIKE ECO Lab template(s) should first be imported to MIKE+. Then, WQ components must be created in the 'WQ components' editor as appropriate and each MIKE ECO Lab state variable must be associated to a WQ component. Make sure that the WQ component is set to use the unit which is expected for the state variable in the template file. Possible unit inconsistencies must be considered and resolved by providing proper conversion factors. Note that no other unit conversion / correction will be performed during the simulation.

Values of constants should be reviewed and modified as appropriate, as well as user-defined forcings.

Initial conditions and boundary conditions of the WQ components in the 1D network must also be specified when they should differ from 0. They must be defined for all components for the 2D overland model, even when they equal 0.

Result items from the MIKE ECO Lab model to be saved to result files during the simulation, must be configured in the 'Result files' editor.

The simulation with MIKE ECO Lab is activated by activating the 'Transport (AD, SWQ)' and 'Water quality (MIKE ECO Lab)' modules for the simulation setup in the Simulation Setup editor (Figure 10.9).

Simulation setup

Identification

ID: WQ\_model\_1

Scenario: Base

Buttons: Insert, Copy, RUN, Delete, Validate

General | HD | AD and WQ | Results

Simulation Type

Features

- Catchments
- Collection system network
- River network
- 2D Overland

Modules

- Rainfall-Runoff (RR)
- Catchment discharge (CD)
- Hydrodynamic (HD)
- Long term statistics (LTS)
- Transport (AD, SWQ)
- Water quality (MIKE ECO Lab)
- Sediment transport (ST)
- Data assimilation (DA)

Couplings

- Coupling to MIKE HYDRO River
- Coupling to MIKE 21 or MIKE 3 FM

Simulation Period

Start: 25/03/2022 12:00:00

Duration: 3 12 0 0 [dddd][hh][mm][ss]

End: 29/03/2022 00:00:00

Description

Buttons: Boundary Info., Set max. time

Table:

ID	Scenario	Active simulation	Catchments	Collection system network	River network	2D Overland	Rai
1	WQ_model_1	Base	<input checked="" type="checkbox"/>	<input type="checkbox"/>	<input checked="" type="checkbox"/>	<input type="checkbox"/>	<input checked="" type="checkbox"/>

Figure 10.9 Setting up a MIKE ECO Lab simulation in the Simulation Setup editor

In the 'AD and WQ' tab page, define the MIKE ECO Lab update frequency and the MIKE ECO Lab Integration method to use for the simulation. The update frequency is a parameter that defines how often the water quality processes will be calculated during the simulation. It is defined as a multiple of the simulation time step used for the HD and AD simulation and therefore determines the frequency for simulating water quality processes on top of the standard Advection and Dispersion processes which are calculated at every time step. The Update Frequency must be a positive integer. Definition of the frequency should be based on careful considerations. The dynamics of the advection dispersion is comparable to the dynamics of the process descriptions. Thus, it is strongly recommended to use an update frequency of 1. The selection of the Update Frequency has to be based on considerations of the time scales of the processes involved. Please notice that this selection can be rather decisive for the precision of the numerical solution as well as for the CPU time of the simulation. A large Update Frequency will decrease the precision as well as the CPU time. It is therefore advisable to perform a sensitivity analysis on the Update Frequency before making the final selection. Also see Chapter 10.2.1 Notes on MIKE ECO Lab (p. 378) for more information on the Integration Methods.

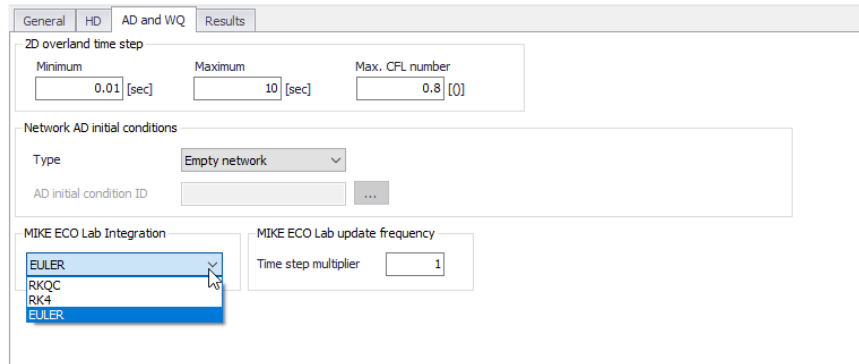

Figure 10.10 Define the MIKE ECO Lab Integration Method in the AD and WQ tab page of the Simulation Setup editor.

In the 'Results' tab, select the result files to be saved during the simulation.





## 11 Data Assimilation

### 11.1 General parameters

The general parameter definition includes the selection of data assimilation simulation mode as well as definition of a few general, mode-specific parameters.

#### 11.1.1 Mode selection

Three data assimilation modes are available:

- Updating with weighting function: this mode performs a state updating of model parameters applying user-defined weighting functions to estimate the updates applied to simulation results. The simulation is updated up to the Time of Forecast. Additionally, an 'Error forecast' correction option may be applied after Time of Forecast, if selected.
- Updating with Kalman filter: this mode updates the model with the ensemble Kalman filter based on Monte Carlo simulation techniques.
- Uncertainty prediction: uses Monte Carlo simulation to propagate uncertainties in the boundary conditions and assess uncertainties in the simulated model outputs.

In the current version, only the mode 'Updating with weighting function' is available.

#### 11.1.2 Basic parameters

**First updating time step:** The time step number at which the model starts to be updated. This parameter is only available for updating using either the weighting function or the Kalman filter. A value of 0 corresponds to the first time step of the simulation and e.g. a value of 100 corresponds to the updating only starting at simulation time step number 100 and forward. Starting the update later than time step 0 may ensure that the stochastic process is sufficiently evolved to give good estimates of the uncertainty before the first update, thereby getting rid of potential instabilities occurring at the beginning of the simulation.

**Ensemble size:** Number of simultaneous runs that are to be carried out to evaluate the statistical properties needed for the uncertainty assessment output and also for determining the updating parameters applied in the Kalman filter. This parameter is hence only available for Kalman filter or uncertainty prediction simulation mode. The quality of the statistical estimates is strongly dependent on the ensemble size: the larger the ensemble size the higher the confidence in the results. On the other hand, the ensemble size has a linear effect on the run time, that is, when the ensemble size is doubled the run-time



is also doubled. Recommended values are 50-200. If only reliable estimates of standard deviations are of importance, a smaller value may be chosen. When producing confidence intervals an estimate of the full uncertainty distribution is needed, thus an increase in the ensemble size is recommended for such cases.

### 11.1.3 Forecast

**Time of forecast:** Date and time at which the model switches to forecasting mode. Parameter is available when performing updating either with the Weighting function or the Kalman filter. Model state updating is only performed till the Time of Forecast.

**Forecast type:** This option is only available for the Kalman filter option and gives a choice of applying deterministic or stochastic forecasting. At time of forecast, 'Deterministic' forecasting runs a single ensemble member based on the ensemble mean state at time of forecast. The 'Stochastic' type continues evaluating all ensembles after time of forecast, applying boundary perturbations similarly to an uncertainty prediction run.

## 11.2 Update parameters

The 'Update parameters' editor is used when the data assimilation mode is set to updating with either the Weighting function or the Kalman filter method. It defines model locations where model updating is to be done, as well as the update settings.

Update definitions (i.e. updated points in the model) are added or deleted using the 'Insert' or 'Delete' buttons at the top of the editor. They can also be added, edited and deleted from the map, working with the 'DA update' target layer.

Each update definition represents a location where observed data are available and where the model is going to be updated. The simulation will actually be updated only for locations where the 'Apply' option is active. When this option is not selected, the update definition is ignored during the simulation. To define an observation location, the parameters below have to be specified.



**Note:** For the 'Updating with weighting function' mode, a .dfs0 time series is created with data describing the update process. This file is created in the folder containing the MIKE+ database, and contains the following variables obtained at the observation point:

1. Mod: The difference between simulated and observed values before update
2. Err: Error from the error equation
3. Sim: Simulated value after update



4. Obs: Observed value
5. Est: Estimated error from the error forecast model (only available when the equation uses an estimated constant).

### 11.2.1 Measurement location

River ID: The name of the river where the observation point is located. It can be chosen from the list opened using the '...' button.

Chainage: Chainage along the river where the observed data are located. The chainage does not have to coincide with the location of a calculation point since MIKE+ uses a linear interpolation for determining the simulated value at the appropriate measurement location.

Updated item: The type of variable on which the update is performed. Depending on the modules included in the simulation (in the 'Model type' editor), the type can be either a water level, a discharge or a WQ component.

WQ component: The component to be updated must be selected from the list of components defined for the Transport module.

File name: The time series file containing the observed data. The '...' button may be used to either browse, create or edit the time series.

Item ID: This field shows the name of the item selected in the time series.



ID	Apply	River ID	Chainage [m]	Updated item	WQ component	File name	Item ID	Distrib
1	<input checked="" type="checkbox"/>	Ster Vraz	8200	Water level		Observed_water_level.dfs0	Observed	Const

Figure 11.1 The Update parameters editor

## 11.2.2 Weighting function

The 'Weighting function' tab is visible when data assimilation mode is 'Updating with weighting function'.

A weighting function definition must be specified for each update definition with the main purpose of defining how model corrections at the measurement location are distributed to neighboring calculation points in the river network.

Distribution type: Three different types of distribution are available:

- **Constant:** in this case the error correction is distributed evenly over the grid points between the specified smallest and highest chainages.
- **Triangular:** in this case the error correction is linearly decreasing from a maximum correction at the measurement location (specified in the 'Measurement location' tab) to 0 at the smallest and highest chainages.
- **Mixed exponential:** in this case the error correction is decreasing according to an exponential function from a maximum correction at the measurement location to the smallest and highest chainages, where the correction is about 0.01 times the correction at the measurement location.





**Amplitude:** The amplitude specifies the fraction of the observed error at the measurement location that should be applied as error correction at that point. The amplitude should reflect the confidence in the observation as compared to the model forecast. That is, if the amplitude equals one, the measurement is assumed to be perfect, whereas for smaller amplitudes, less emphasis is put on the measurement as compared to the model forecast.

**Smallest chainage:** It represents the start point along the river where the correction is applied (in the river where the measurement point is located). It corresponds to the upstream chainage for a river with a positive flow direction, or the downstream chainage for a river with a negative flow direction.

**Highest chainage:** It represents the end point where the correction is applied (in the branch where the measurement point is located). It corresponds to the downstream chainage for a river with a positive flow direction, or the upstream chainage for a river with a negative flow direction.

**Include connected rivers:** If this option is selected, the correction is also applied to tributaries (if any) which are connected to the main river between the specified smallest and highest chainages. The correction is applied within the same extent and with the same amplitude and distribution as for the river where the measurement is located.

**Soft start:** Number of time steps used to fade up the correction initially, starting from zero correction at the first updated time step up to full correction after the fade-up period. This function helps avoiding model instabilities since the error correction value is applied gradually rather than abruptly.

**Include error forecast:** The weighting function update procedure up to Time of Forecast may be combined with error forecasting at updating points, in the forecast period (i.e. after the time of forecast). This avoids discontinuities that would occur by stopping the correction abruptly at the Time of forecast. Error forecasting is included only when the option is selected. It is mandatory and always included, when updating on discharge measurement. When active, an equation defining how the calculated error function is forecasted over time must be selected, e.g. as a function of the correction from the previous time steps. Forecast Equations are defined in the 'Error forecast equations' editor.

### 11.2.3 Standard deviation

The 'Standard deviation' tab is visible when performing updating with the Kalman filter only. The standard deviation must be specified for each update definition.

**Type:** The standard deviation may be of three different types:

- **Constant:** the standard deviation is defined by a constant value.



- **Relative:** the standard deviation is taken as a relative value (percentage) of the measurement. Note that the percentage is applied to the absolute value, when the updated item is a discharge or WQ component. When updating on water level, the percentage is interpreted as being with respect to the water depth.
- **Time series:** the standard deviation may vary with time with the variation defined in a time series file.

**Value:** The value used as constant or relative standard deviation.

**File name:** The time series file containing the time varying standard deviation. The button to the right may be used to either browse, create or edit the time series.

**Item ID:** This field shows the name of the item selected in the time series.

**Apply lower limit:** When applying a relative or time varying standard deviation, the user may apply a lower bound on the standard deviation, by activating this option. The lower limit must then be specified in the value field to the right.

**Apply upper limit:** When applying a relative or time varying standard deviation, the user may apply an upper bound on the standard deviation, by activating this option. The upper limit must then be specified in the value field to the right.



**Important:** When updating is applied, the model state is updated using observed data up to the time of forecast. After Time of Forecast, forecasting is performed either using the error prediction model (if an equation has been defined), or for Kalman filter updating either using a stochastic or deterministic forecast. This functionality therefore assumes that observed data are available up to the time of forecast. In case observed data are missing before the time of forecast, the simulation will still run, but the following rules will apply:

- If observed data are missing at the beginning of the simulation, the updating will only start at the time when observed data become available
- If the model is being updated and if some observed data are missing before the time of forecast, the error prediction model will be applied
- If some observed data are available before the time of forecast but not sufficiently to compute the error prediction, or if no observed data at all is available before the time of forecast, then the update location is fully disabled during the simulation. That is, no update or error prediction is performed at this location.



## 11.2.4 Description

The description tab can store information describing the measurement location and its update parameters.

## 11.3 Error forecast equations

The 'Error forecast equations' editor is only available when performing updating with weighting function.

Equations are used to specify how error correction functions derived during the update period (simulation time up to Time of Forecast) is applied during the forecast period.

New equations are added or deleted using the 'Insert' or 'Delete' buttons at the top of the editor.

ID	Description	Equation	From [h]	To [h]
1	Equation1	C*E(-1)	-24	0

Figure 11.2 The Error forecast equations editor

### 11.3.1 Identification

ID: The identification name of the equation.

Description: An optional description of the equation.

### 11.3.2 Equation definition

Equations are specified in this 'Equation' field.

The 'Edit' button gives access to the expression editor, from which it is possible to select the available parameters (in the 'Variables' column) as well as a



number of operators and functions. Equation parameters should therefore be added and defined before editing the equation.

As an example, suppose the error forecast model is to be expressed as a function of the variables X1, X2 and X3 as 5 times variable X1 minus the square of variable X2 plus 2 times the natural logarithm of X3, the Equation field should be written:

$$5*[X1] - \text{Power}([X2], 2) + 2*\text{Log}([X3])$$

Where:

X1, X2 and X3 are defined equation parameters.

Another example: assuming that the error forecast model is based on a second order auto regressive model, the Equation field should be written:

$$[A] * E(-1) + [B] * E(-2)$$

Where:

A and B are the auto regressive equation parameters.

E(L) is the error function with time lag L ( $L < 0$ ). That is, E(-1) is the error correction value at the previous time step.

### 11.3.3 Parameter definition

Parameters to be used in the Equation definition are specified here. Parameters are added or removed using the 'Insert' or 'Delete' buttons above the table.

ID: Identification name of the equation parameter.

Type: Equation parameters can be defined as one out of four types:

- Constant value: the parameter is assigned a constant value.
- Estimated constant: a constant value with an automatic estimation performed to estimate the value from the computed time-varying error.
- Time series: the parameter is assigned a time-varying value specified in an external time series.
- State variable: the parameter is a state variable, e.g. a computed water level or discharge at a grid point in the river network.

Depending on the selected type for the equation parameter, specific parameters must be defined. Specific parameters for 'Constant value' type include:

- Value: value assigned to the parameter.



Specific parameters for 'Estimated constant' type include:

- Minimum value: lower bound of the parameter.
- Maximum value: upper bound of the parameter.

Specific parameters for 'Timeseries' type include:

- File name: the path to the time series containing the values. The button to the right may be used to either browse, create or edit the time series.
- Item ID: this field shows the name of the item selected in the time series.

Specific parameters for 'State variable' type include:

- River ID: the river name where the state variable is located.
- Chainage: the chainage at which the state variable is located.
- Item: defines the type of state variable. Depending on the modules included in the simulation (in the 'Model type' editor), it can either be water level, discharge, or WQ component.
- WQ component: the name of the component from the Transport module, when the updated item is set to WQ component.

### 11.3.4 Estimation period

For parameters defined as 'Estimated value', automatic parameter estimation is applied based on the record of computed errors. The period of the record to be used for the parameter estimation can be specified relative to the time of forecast.

This option allows parameters of the error forecast models to be updated continuously, and hence the error forecast models to adapt from one forecast to the next to the prevailing conditions at the time of forecast. For instance, the error forecast models can be adapted to the structural differences in the model errors that are often seen for different flow regimes.



Note: If the amount of observed data available before the time of forecast is not enough to compute the error forecast, the updating location may be disabled. Be aware that computing the error on a long period will therefore increase the risk that the update is disabled, when only a limited set of observed data is available.

## 11.4 Standard deviation

The 'Standard deviation' editor is available only when performing updating with Kalman filter or uncertainty prediction. This editor enables definitions of standard deviation specifications, which are used in the specific perturbation definitions at boundary locations in the model.



Standard deviations are added or deleted using the 'Insert' or 'Delete' buttons at the top of the editor.

### 11.4.1 Identification

ID: Identification name of the standard deviation.

Description: An optional description of the standard deviation.

### 11.4.2 Standard deviation definition

Data type : The data type to which the standard deviation may be applied. Only the standard deviations with the appropriate data type can be selected for a given perturbation, depending on the data type the perturbation is applied to.

Type: The standard deviation may be of three different types:

- Constant: the standard deviation is defined by a constant value.
- Relative: the standard deviation is taken as a relative value of the boundary condition. Note that the percentage is applied to the absolute value, when the data type is discharge, wind velocity, wind direction, precipitation, temperature, salinity or concentration. When updating on water level, the percentage is interpreted as being with respect to the water depth.
- Varying in time: the standard deviation may vary with time with the variation defined in a time series file.

Value: The value used as constant or relative standard deviation.

File name: The path to the time series containing the time varying standard deviation. The button to the right may be used to either browse, create or edit the time series.

Item ID: This field shows the name of the item selected in the time series.

Time constant before TOF: The time constant before Time of Forecast should be interpreted as the time it takes for the correction to drop to half the initial magnitude (exponential decay). The errors applied at the boundaries may be described through a first order auto regressive process:

$$\xi_{n+1} = \phi \xi_n + \varepsilon \quad (11.1)$$

Where:



$\xi_n$  is the error at time step n  
 $\phi$  is the regression coefficient and  
 $\varepsilon$  is white noise

The regression coefficient should be interpreted as the "memory" of the model error. To ensure that this "memory" is independent of the time step used, the user is required to specify a time constant instead. The relation between the regression coefficient and the time constant is:

$$\phi = \exp\left(-\frac{\Delta t \cdot \ln 2}{T_{1/2}}\right) \quad (11.2)$$

where

$\Delta t$  is the simulation time step  
 In the logarithm with base e and  
 $T_{1/2}$  the time constant TC.

The numerical value of the regression coefficient must be less than unity to ensure that the variance of the model error is limited. A negative time constant results in a regression coefficient which is greater than unity.

The model errors being described through the auto regressive process are used in the forecast period to generate errors to be added to the boundaries. If the forecast is deterministic, the model errors are described through the auto regressive process without adding white noise. The model errors fade out according to an exponential decay.

Time constant after TOF: See description above for Time constant before TOF.

Apply lower limit: When applying a relative or time varying standard deviation, the user may apply a lower bound on the standard deviation, by activating this option. The lower limit must then be specified in the value field to the right.

Apply upper limit: When applying a relative or time varying standard deviation, the user may apply an upper bound on the standard deviation, by activating this option. The upper limit must then be specified in the value field to the right.



ID	Data type	Type	Set-point value	File name	Item ID	Time constant before TOF [h]	Time
1	Std_dev_1	Discharge	Relative	15		2	

Figure 11.3 The Standard deviation editor

## 11.5 Perturbations parameters

Perturbations are added or deleted using the 'Insert' or 'Delete' buttons at the top of the editor.

### 11.5.1 Identification

ID: Identification name of the perturbation.

Description: An optional description of the perturbation applied to boundary conditions.

### 11.5.2 Perturbation definition

Apply perturbation to: The type of boundary item to which the perturbation is applied. Depending on the modules included in the simulation (in the 'Model type' editor), the types may be:

- Water level
- Discharge
- Q/h relation
- Global wind field
- Distributed wind velocity
- Distributed wind direction
- Input to catchment





- Output from catchment
- WQ component.

**Boundary condition ID:** The ID of the boundary condition to which the perturbation is applied. Boundary IDs are extracted from the list of defined boundary conditions and it is therefore required to define boundary conditions prior to defining perturbations.

**Standard deviation:** The standard deviation, defined in the 'Standard deviation' editor, which is applied for this perturbation. It can be selected from the list opened using the '...' button, which shows only the valid standard deviations depending on the item type to which the perturbation applies. Note that when the perturbation is applied to a Q/h relation, the corresponding standard deviation must have a Water level type.

**Catchment ID:** The name of the catchment to which the perturbation is applied, when it's applied to an input to catchment or output from catchment.

**WQ component ID:** The component from the Transport module, when the perturbation is applied to WQ component.

**Item:** Depending on the type of boundary item to which the perturbation is applied, the selected item can be:

- Choice between wind velocity or wind direction, when the perturbation is applied to the global wind field
- Choice between rainfall, evaporation or temperature, when the perturbation is applied to an input to catchment
- Choice between runoff or net precipitation, when the perturbation is applied to an output from catchment.



Perturbations parameters

Description

ID:

Description:

Perturbation definition

Apply perturbation to:  Standard deviation:

Boundary condition ID:

Table controls:  ID    Show selected  Show data errors 1/1 rows, 0 selected

	ID	Apply perturbation to	Boundary condition ID	WQ component ID	Item	Standard deviation
▶ 1	Perturbation_1	Discharge	Upstream		Wind velocity	Std_dev_1

Figure 11.4 The Perturbations parameters editor



## 12 Calibrations

Model calibration is important to ensure that model predictions represent the actual hydraulic and water quality conditions in the system. Calibration of the model is important when model results are to be used for decisions regarding remedial actions, augmentation works, forecasting, etc.

Calibration is primarily focused on reproducing the observed hydraulics and water quality behaviour of the system in terms of flow depth/pressure, flow discharges and velocities. The model calibration should include comparisons between model simulation results and field measurements for, but not limited to, the following:

- Flow
- Water level / Pressure / Hydraulic head
- Velocity
- Water mass balance
- Contaminant concentrations
- Contaminant migration rates
- Degradations rates

Usually these comparisons are presented in maps, tables or graphs. The calibration results need to be evaluated by the modeller using engineering professional judgement. There are no universally accepted 'goodness of fit' criteria that can be applied in all cases. However it is important that the user makes every attempt to minimize the difference between model simulations and measured field data.

The model calibration procedure is supported in MIKE+ wherein calibration plots of simulated and measured value can be set up and visually compared. Also, statistical analysis can be performed to determine the goodness of fit in MIKE+. The calibration plots and statistics are written to a report as documentation and for further report processing.

### 12.1 Measurement Stations

Measurement stations, representing locations of flow gauges, pressure meters, and the like, can be defined in MIKE+. It is possible to graphically add a measurement station on the map as well as directly on the editor (Calibrations | Measurement Stations) (Figure 12.1).

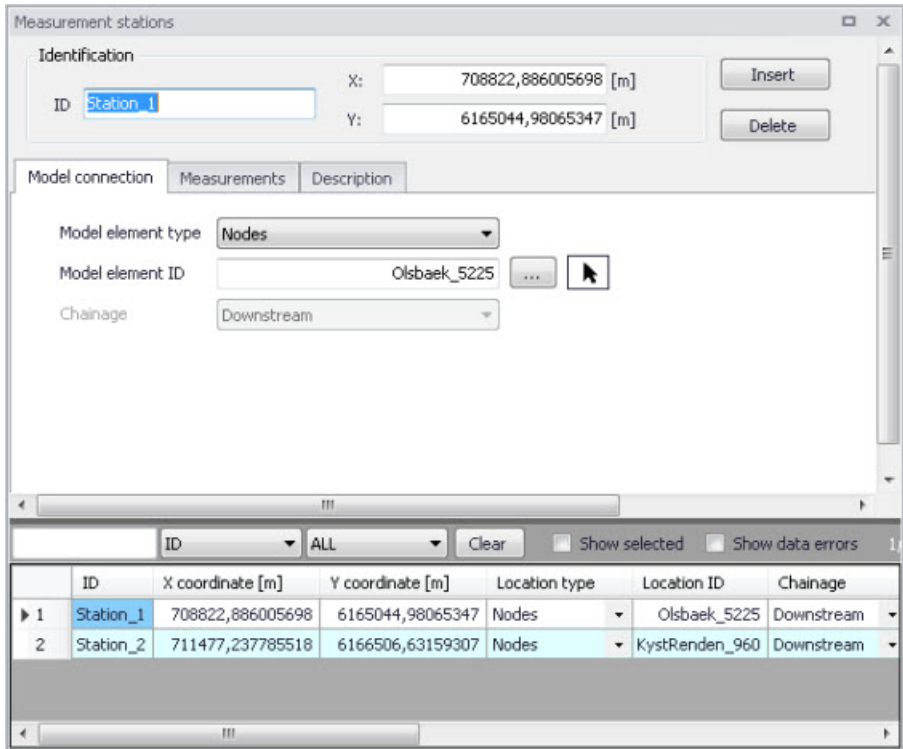

Figure 12.1 The Measurement Stations Editor

The stations can be viewed on the Map providing the user an overview of monitoring locations. Additional information such as an image and description may be provided for a station.

Graphically add a station on the map using the 'Create' layer editing tool, specifying 'Measurement stations' as the Target layer. As with other point layers, the 'Create', 'Edit', and 'Delete' tools are available for measurement stations.

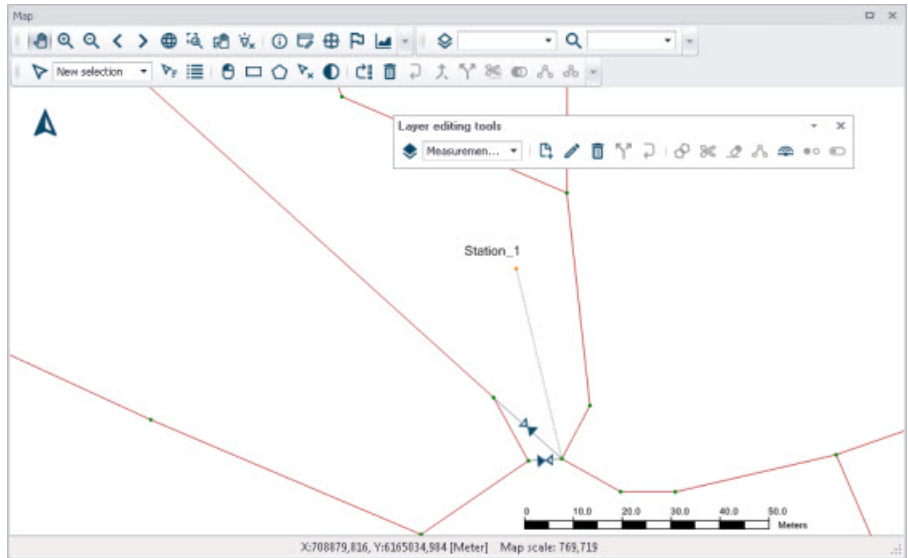

Figure 12.2 Graphically add or edit Measurement Stations on the Map using Layer Editing Tools. The example shows the creation of 'Station\_1' on the map.

The various parts of the Measurement Stations editor are described in succeeding sections.

### 12.1.1 Identification

The Identification group box holds information on the measurement station ID and location. Use the 'Insert' button to add new measurement stations in the Editor.



Figure 12.3 The Identification group box on the Measurement Stations Editor

### 12.1.2 Model Connection

The stations need to be associated (i.e. geocoded) with elements of the model network to link the measurement station with a modelling result item.

Associate measurement stations with specific model elements in the Model Connection tab on the Measurement Stations Editor (Figure 12.4).

The screenshot shows a software window titled "Measurement stations" with three tabs: "Model connection", "Measurements", and "Description". The "Model connection" tab is active. It contains the following fields and controls:

- Identification:**
  - ID: Station\_2
  - X: 711477,237785518 [m]
  - Y: 6166506,63159307 [m]
  - Buttons: Insert, Delete
- Model connection:**
  - Model element type: Nodes (dropdown menu)
  - Model element ID: KystRender\_960 (text field with an ellipsis button and a cursor icon)
  - Chainage: Downstream (dropdown menu)

Figure 12.4 The Model Connection Tab on the Measurement Stations Editor

### Model Element Type

Define the model element type to be associated with a measurement station by selecting an element type from the dropdown menu. Model element types that may be linked to stations are:

- Nodes
- Pipes and Canals
- Pumps
- Weirs
- Orifices
- Valves
- Curb Inlets

### Model Element ID

Define the ID for the particular model element to associate with a station.

Use the ellipsis button to select the ID from a list.

Use the cursor button to graphically select the element on the Map.

### Chainage

For stations connected to links, there is an option to specify the chainage or computational grid point of the connection - either Upstream, Middle or Downstream of the link.

Note that connections lines between stations and the network are displayed on the map after model connections are specified for stations. Also, on the Map View, the 'Connect station' tool is available from the 'Layer editing tools' toolbar for connecting stations to network elements.



### 12.1.3 Measurements

Define time series for externally measured data for a station in the Measurements Tab on the Measurement Stations editor (Figure 12.5).

Add an external time series item via the secondary grid in the tab by specifying the time series file location under the 'File' column. A plots of a specified time series is shown to the right of the secondary grid.

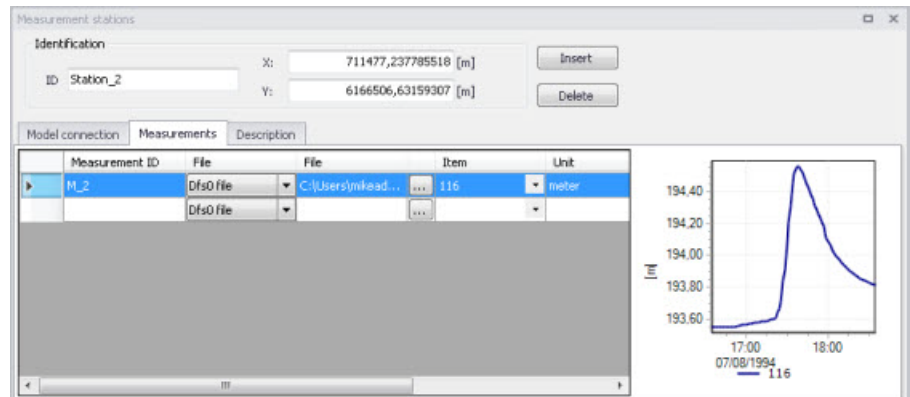

Figure 12.5 The Measurements Tab on the Measurement Stations Editor

The Measurements secondary grid has the following data columns:

#### Measurement ID

The unique identifier for the measurement time series.

#### File

Measurement time series data may be in .DAT or .DFS0 file formats.

#### Item

The item to use from the time series file.

#### Unit

Displays the units for the selected time series item.

#### Start

Displays the start date and time for the time series.

#### End

Displays the end date and time for the time series.

#### Action (Edit)

Launches the Plots and Statistics Editor wherein comparisons of the measured data with simulation results may be configured.

## 12.1.4 Description

The Description tab allows the modeller to add descriptive information for the Measurement Station. An image may also be added using the 'Add picture' button.

Figure 12.6 The Description Tab on the Measurement Stations Editor

Table 12.1 below shows an overview of the various parameters on the Measurement Stations Editor.

Table 12.1 Overview of the Measurement Stations editor attributes (Table m\_Station)

Edit field	Description	Used or required	Field name in data structure
ID	Station identified	Yes	MUID
X	X coordinate of the station	Yes	-
Y	Y coordinate of the station	Yes	-
Model Element Type	Type of connected model element	Yes	LocationType
Model Element ID	ID if connected model element	Yes	LocationID
Chainage	Model element grid point associated with measurements	Yes If Model Element Type = Pipes and canals	Chainage





Table 12.1 Overview of the Measurement Stations editor attributes (Table m\_Station)

Edit field	Description	Used or required	Field name in data structure
Description	Free text description of the measurement station	Optional	Description
Data Source	Source of data	Optional	DataSource
Asset ID	Station ID in asset database	Optional	AssetName
Status	Information on data status	Optional	Element_S
Network Type	Information on the type of network	Optional	NetTypeNo
Bottom Level	Bottom level at measurement point	Optional	BottomLevel
Model	Model group under which the station is categorised	Optional	SubModelNo

## 12.2 Plots and Statistics

The Plots and Statistics dialog allows the user to compare measured data with simulation results at measurement stations.

Set up a calibration plot on the Plots and Statistics Editor (Figure 12.7), where a reference file with observation data is loaded and compared to a result file. Multiple plot and statistics setups may be created for a project.

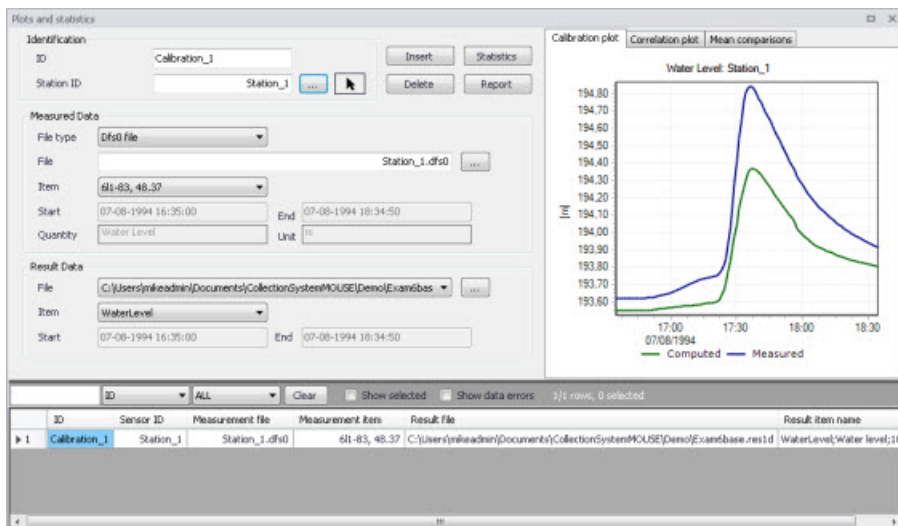

Figure 12.7 The Plots and Statistics dialog

The user can opt to plot a correlation plot, presenting the deviation of simulated results from observed data.

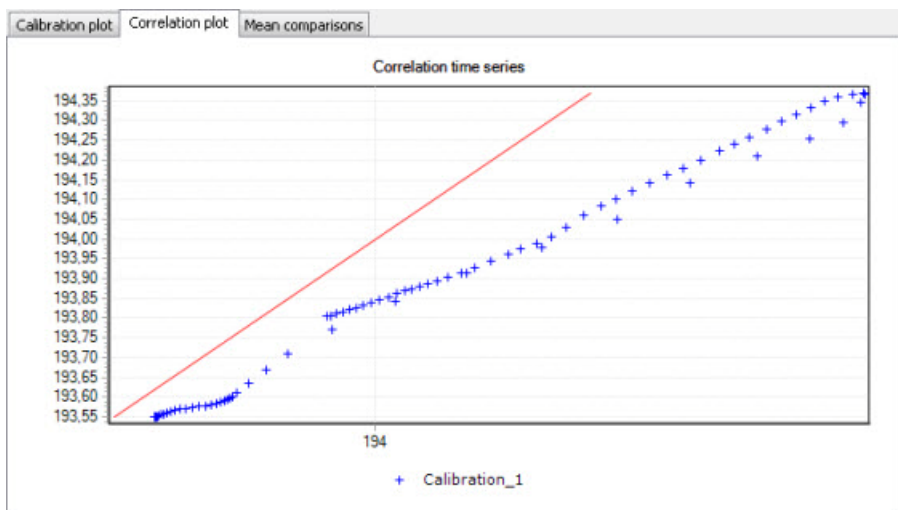

Figure 12.8 Example correlation plot

Below is an example of a mean comparison plot wherein the mean value for simulated results is compared to the mean value for measured data.

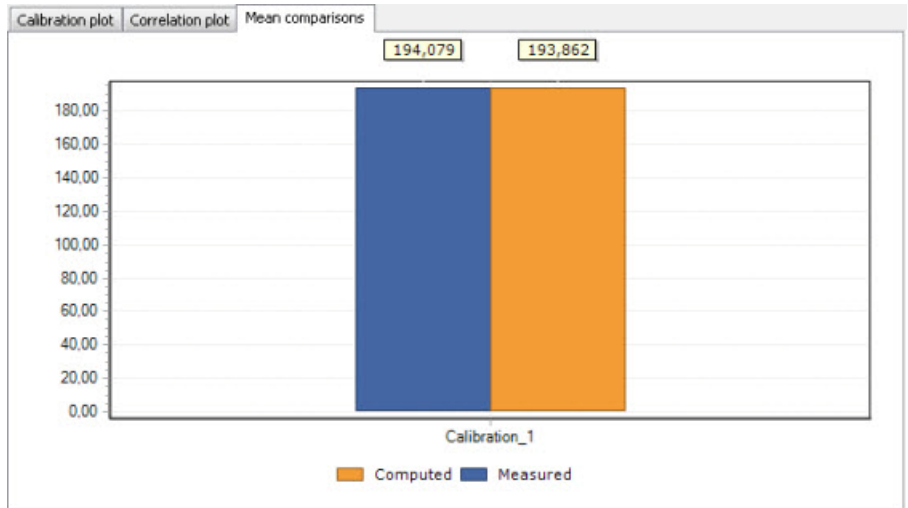

Figure 12.9 Example mean comparison plot

Table 12.2 Overview of the Plot and Statistics editor attributes (Table m\_Measurement)

Edit field	Description	Used or required	Field name in data structure
ID	Each time a record is added an automatic ID is given of the form: Calibration_1, Calibration_i.... This may be changed to something more descriptive	Yes	m_Measurement.MUID
Station ID	The ID of the Measurement Station	Yes	m_Measurement.StationID
File Type	Measurement time series data may be in .DAT or .DFS0 file formats.	Yes	-
Measured Data File	External file name and path - this is where the measured time series is linked to the measurement station	Yes	TSFileName



Table 12.2 Overview of the Plot and Statistics editor attributes (Table m\_Measurement)

Edit field	Description	Used or required	Field name in data structure
Measured Data Item	Display of item in the measured time series	Yes	TSItemName
Measured Data Start	Auto filled with the time series file start time. Used to control the Start time for comparison	Yes	-
Measured Data End	Auto filled with the time series file end time. Used to control the End time for comparison	Yes	-
Measured Data Quantity	Displays item name for selected item from measurement time series	Yes	-
Measured Data Unit	Displays units used for selected item from measurement time series	Yes	-
Result Data File	Result file name and path	Yes	ResFileName
Result Data Item	The result file item being compared to measurements	Yes	ResItemName
Result Data Start	Display of simulated result time series start date and time	Yes	-
Result Data End	Display of simulated result time series end date and time	Yes	-

The following button functionalities are available on the Plots and Statistics dialog:

#### Insert

Inserts a new Plot and Statistics item.



### Delete

Deletes the active Plot and Statistics item.

### Statistics

Displays various statistics parameter values, such as Mean error and RMS error, used for evaluating the comparison between simulated values and measurements.

### Report

Option for exporting a report in various file formats about the time series comparisons.





## 13 Result Specifications

MIKE+ allows flexible generation of model simulation result files and summaries. Various result file setups may be specified in the Result Specifications section, which may then be used in a simulation as needed by the user.

Result files obtained from simulations may be customised with respect to the number of result files generated, file types, spatial extent of saved results, and types of result items included in the files.

In MIKE+, **one result file** may be set up to contain **multiple result sets** comprised of **various location-item combinations** (see Sections 13.1.6 and ‘User-specified results’).

Result file and custom network summary specifications are defined under the following editors:

- **Result Files.** Result files obtained from simulations may be customised with respect to the number of result files generated, file types, spatial extent of saved results, and types of parameters included in the files.
- **Network Summary.** Basic HTML summaries for network simulations may be extended by adding supplementary tables to the summary.

### 13.1 Result Files

The Result Files editor (Figure 13.1) provides a facility for viewing and specifying result file setups in a project. The types or results available depend on the active features and modules for the project (General Settings | Model type).

Result setups are a mix of Default results and User-specified results.

#### Default results

The editor is initially filled with Default result setups. A Default set is shown for each active Module in the project. These records are distinguished by the “Default\_” prefix in their IDs.

The following table shows an overview of the various Default result files that are possible in MIKE+.

Table 13.1 Overview of possible Default result files in MIKE+

Default ID	Model Type	Format	Content Type
Default_Surface_runoff	Catchments	.RES1D	Surface runoff
Default_RDII	Catchments	.RES1D	RDII



Table 13.1 Overview of possible Default result files in MIKE+

Default ID	Model Type	Format	Content Type
Default_Storm_wa- ter_quality	Catchments	.RES1D	Storm water quality
Default_Storm_wa- ter_sediments	Catchments	.RES1D	Storm water sedi- ments
Default_LIDs	Catchments	.DFS0 (currently hard- coded)	LIDs
Default_Catch- ment_discharge	Catchments	.RES1D	Catchment dis- charge
Default_Catch- ment_dis- charge_quality	Catchments	.RES1D	Catchment dis- charge quality
Default_Net- work_HD	Network	.RES1D	Hydrodynamic
Default_Net- work_RTC	Network	.RES1D	Real time control
Default_Net- work_AD	Network	.RES1D	Pollution transport
Default_Network_- MIKE_ECOLab	Network	.RES1D	MIKE ECO Lab
Default_LTS_ex- treme_statistics	Network	.RES1D	LTS extreme statis- tics
Default_LTS_chron- ological_statistics	Network	.RES1D	LTS chronological statistics
Default_2D_over- land	2D Overland	DFSU / DFS2	2D area
Default_2D_over- land_AD	2D Overland	DFSU / DFS2	2D area, AD
Default_2D_- Flood_statistics	2D Overland	DFSU / DFS2	2D flood statistics
Default_2D_Vol- ume_balance	2D Overland	DFS0	Volume balance

Default result sets include results in all model elements, saving values for the basic calculation parameters.

Default result sets may be modified with respect to selection of results items to be included in the file. Only basic result items are initially included in Default result setups.

Note that the saving locations may not be modified for Default results, and results will always be saved in all elements.





Also note that for some content types, only one file format is allowed and cannot be changed.

## User-specified results

The user may also define custom result file setups according to their modeling needs.

The following properties may be customised for user-specified results:

- File format
- Location: Spatial extent or network elements for which results are saved in the file.
- Result items: Calculated parameters to be included in the file.

Note that **multiple result sets comprised of various location-item combinations may be specified for one user-specified result file** (see Section 13.1.6 for more details).

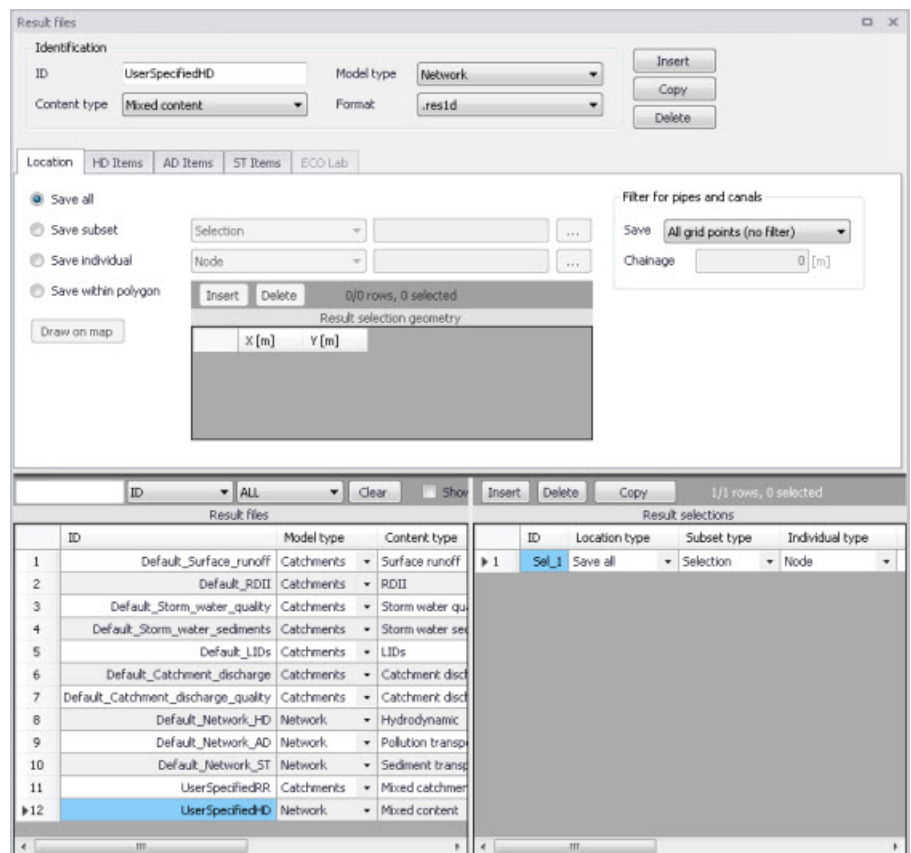

Figure 13.1 The Result Files Editor

The various data tabs and components of the Result Files editor are described in succeeding sections.

### 13.1.1 Identification

The Identification group box on the Result Files editor contains general information on a result file item.



Figure 13.2 The Identification group box on the Result Files Editor

#### Model Type

Each result file item is categorised based on the type of model from which it is generated. The model may either be a Catchment model, a Network model (comprising CS network and/or River network) or a 2D Overland model.

#### Content Type

This parameter characterises result files according to the calculation modules, and filters the available result items that may be included in the result file setup. The available categories depend on the selected Model Type for a result file setup.

Note that there are also “mixed content” types, which allow flexibility in terms of mixing result items across various active computational modules in one result file setup (See Section 13.1.6).

Content Type can be:

- For ‘Catchments’ Model Type:
  - Mixed catchment contents. Content type for which result items across various active catchment model-related computational modules may be included.
  - Surface runoff
  - RDII
  - Storm water quality
  - Storm water sediments
  - LIDs
  - Catchment discharge
  - Catchment discharge quality



- Statistics. For this content type, the result file will save maximum, time of maximum, minimum, time of minimum, and average values for the selected result items. For the relevant result items, it will also save the accumulated values over time (e.g. volume accumulated over time, for a discharge results). This result file contains a single time step.
- For 'Network' Model Type:
  - Mixed content. Content type for which result items across various active network model-related computational modules may be included (e.g. HD, AD, ST, and MIKE ECO Lab).
  - Hydrodynamic
  - Pollution transport. If the 'Water Quality (AD)' module is active.
  - MIKE ECO Lab. If the 'Water Quality (MIKE ECO Lab)' module is active.
  - LTS extreme statistics. If the 'Long Term Statistics (LTS)' module is active.
  - LTS chronological statistics. If the 'Long Term Statistics (LTS)' module is active.
  - Statistics. For this content type, the result file will save maximum, time of maximum, minimum, time of minimum, and average values for the selected result items. For the relevant result items, it will also save the accumulated values over time (e.g. volume accumulated over time, for a discharge results). This result file contains a single time step.
  - 2D map. This content type provides a 2D result file where results from the 1D simulation are distributed across cross sections and interpolated along the river line. The maps are saved in dfs2 file format (rectangular grids) and constructed through interpolation in space of the 1D grid point results. Thus, the maps constructed in this way should be viewed as a two dimensional interpretation of results from a one-dimensional model.
  - State files (initial conditions). State files store results from all active modules in the simulation (Hydrodynamic, Rainfall-runoff, Transport, etc.) and for a given time step. When 'State files' are included in a simulation, there are actually several files saved during the simulation (one per time step, with the saving period selected in the 'Simulation setup' editor). State files are designed to be used as initial condition afterwards, for another simulation. They contain more detailed information than .res1d files and therefore offer more accurate initial condition definitions. Using state files as initial conditions is also activated in the 'Simulation setup' editor, in the 'HD' tab.



- Decoupling. This produces a special hydrodynamic result file, to be used as input for a decoupled Transport (Advection-Dispersion or Water Quality) simulation. The created special hydrodynamic result file stores the simulated water level and the average discharge per saved time step. Decoupling a transport simulation from the hydrodynamic simulation speeds up the simulation by getting the hydrodynamic conditions from the decoupled result file, instead of running the hydrodynamic simulation at the same time. The decoupling of the transport simulation is activated in the 'Simulation setup' editor.
- For '2D Overland' Model Type:
  - 2D area: a map result file containing instantaneous results at regular time intervals
  - 2D flood statistics: a map result file containing a single time step with statistical results (e.g. maximum values over time)
  - Time series: time series results from one or more cells from the 2D domain
  - Volume balance: a time series providing total volumes over the 2D domain
  - Section discharge: a time series providing the total discharge computed through a cross section
  - 2D area, AD: a map result file containing instantaneous water quality results at regular time intervals
  - Time series, AD: time series of water quality results from one or more cells from the 2D domain
  - 2D culverts results: time series of results in selected culverts. The time series will save for each culvert the target discharge (discharge calculated using the empirical formulas), the discharge (effective discharge, which can be less than the target discharge if the upstream water depth is too low), accumulated discharge, and water level on both sides of the culvert (for a short culvert the left and right water level is the mean water level in the real wet elements to the left and right of the section of faces; for a long culvert the start and end water levels are the mean water level in the real wet elements to the right of the two end sections).
  - 2D weirs results: time series of results in selected weirs. The time series will save for each weir the target discharge (discharge calculated using the empirical formulas), the discharge (effective discharge, which can be less than the target discharge if the upstream water depth is too low), accumulated discharge, and water level on both sides of the weir (the left and right water levels are the mean water level in the real wet elements to the left and right of the section of faces).
  - Section statistics: a \*.dfs0 file with a relative item axis, showing the maximum water depth and/or maximum water level in each element face from the mesh, along a defined cross section. The axis of this result file is the index number of the element faces along the cross section.



## Format

Some result files may be saved in various file formats.

An overview of the Identification group attributes in the Result Files editor is shown in Table 13.2 below.

Table 13.2 Overview of the Identification group box attributes (Table msm\_RS)

Edit field	Description	Used or required by simulations	Field name in datastructure
ID	Unique identifier for the result file setup	Yes	MUID
Model Type	Categorises the model used to generate the result file as either: - Catchment model, or - Network model - 2D overland model	Yes	ModelTypeNo
Content Type	The type of result set under which the result file item falls under.	Yes	ContentTypeNo
Format	The file format for the generated result file is either: - .RES1D - .DFS0 - DFSU - DFS2 - state1d - txt	Yes	FormatNo

The buttons to the right of the Identification group box control the data rows in the left overview table in the Result Files editor.

### 'Insert' button

Adds a new result item in the Result Files table.

### 'Copy' button

Creates a copy of an active result file item. The ID of the copied item is set the same as the original item's ID plus the suffix '\_Copy'.

### 'Delete' button

Deletes the current selected rows from the left overview table in the editor.

## 13.1.2 Location

The flexibility in results-saving in MIKE+ extends to possibilities for selecting elements or specifying locations for which to save results in the file.

Result locations may be defined for user-specified result files, but not for Default results. Note that Default result files will always save results in all model elements (i.e. 'Save all' option).

Result saving locations are specified in the Location tab in the Result Files editor (Figure 13.3).

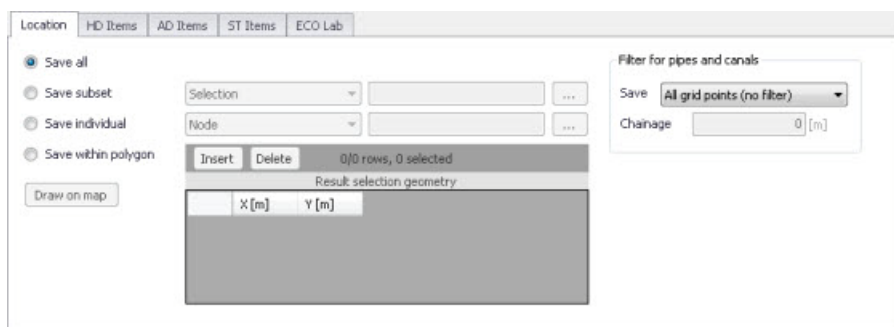

Figure 13.3 The Location Tab in the Result Files Editor

Table 13.3 Overview of the Location tab attributes in the Result Files editor (Table msm\_RSS)

Edit field	Description	Used or required by simulations	Field name in datastructure
[Location radio buttons]	Radio button for selection result saving location: - Save all - Save subset - Save individual - Save within polygon - Save list / all but list	Yes	SelectionNo
[Save Subset dropdown menu]	Dropdown menu for selecting the type of subset	If Location = Save subset	SubsetNo



Table 13.3 Overview of the Location tab attributes in the Result Files editor (Table msm\_RSS)

Edit field	Description	Used or required by simulations	Field name in datastructure
[Selection list input box]	Input box for a Selection List	If Location = Save subset and Subset = Selection	SelectionListID
[Save Individual dropdown menu]	Dropdown menu for selecting the type of model element for which to save results	If Location = Save individual	IndividualNo
[Element input box]	Input box for an element selection	If Location = Save individual	ElementID
Save [Filter for Pipes and Canals]	Option for selecting the calculation grid point(s) along pipes and canals for which to save results	Yes If Model Type = Network, and results are saved in Pipes and Canals	GridPointNo
Chainage [Filter for Pipes and Canals]	Input box for specifying the chainage (i.e. distance from upstream node) of grid point along the pipe or canal for which to save results	Yes If Model Type = Network, results are saved in Pipes and Canals, and Save = User-specified chainage	Chainage

## Save all

This option saves results in all model elements. All Default result files (see Default results, page 417) use this option, which may not be modified. Also note that this option is not available when results are saved in .DFS0 format (see Format section).

## Save subset

This option offers a dropdown list of possible subset groups for which to save results. The list varies according to Model Type associated with the results. A selection list must be defined (Figure 13.4) when the subset is a 'Selection'.

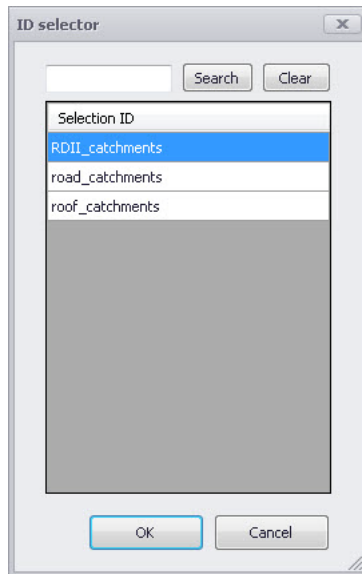

Figure 13.4 Selection lists in the ID Selector window

## Save individual

This option offers a dropdown list of model elements for which to save results. The list varies according to the Model Type associated with the results. An element ID must be defined for the selected model element.

## Save within polygon

Results from only the network elements or the 2D domain elements within a specified polygon are saved in the file. The polygon is characterised by vertex XY coordinates defined in the secondary grid on the Location tab (Figure 13.5).

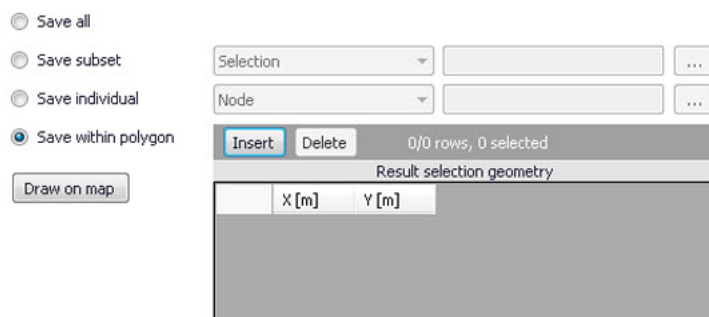

Figure 13.5 The Result Selection Geometry secondary grid in the Location Tab





The location polygon may be defined by:

- Defining values in the secondary table.  
Polygon vertex locations are added and removed from the table using the 'Insert' and 'Delete' buttons at the top of the secondary grid.
- Drawing the polygon on the map using the 'Draw on map' button to the left of the table.  
Use the 'Draw on map' button to define a new polygon on the map. The 'Draw on map' button activates the Map view (Figure 12.5). Draw a polygon on the map by defining vertex locations. Double-click on the map to finish the polygon editing. The polygon coordinates are then shown in the secondary table in the Location tab of the Result Files editor.

The 'Draw on map' button is renamed 'Edit on map' as soon as a polygon has been defined and the secondary table is filled.

Note that the location polygon is shown on the Map only while drawing. The polygon is no longer shown on the map once the polygon has been drawn.

When the polygon already exists (i.e. when the Location tab secondary table is not empty), the 'Edit on map' button allows for editing the existing polygon. The Map is shown, where polygon vertices may be moved, deleted, or added.

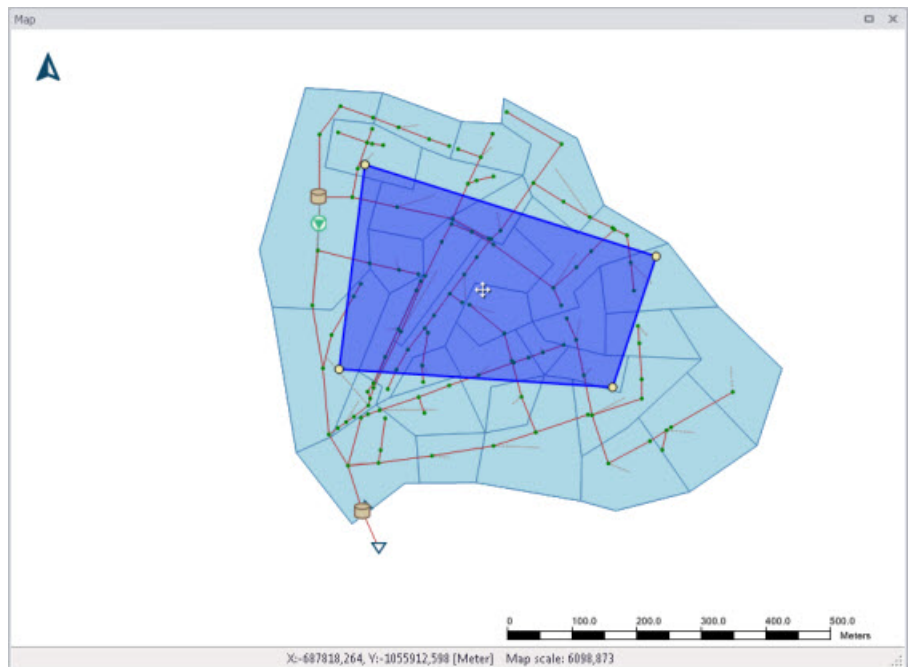

Figure 13.6 Defining a result location polygon on the Map



## Coordinates

For 2D time series data, the X and Y coordinates of the time series must be specified in the table. When multiple coordinates are specified for the same result file, each location will be saved as an individual item in this file. For each time series, the raw results for the 2D domain element in which the coordinates fall will be saved.

For a 2D section discharge result file, coordinates must be specified for the cross section polyline, through which the discharge will be computed.

For a 2D section statistics result file, coordinates must be specified for the cross section polyline, along which the maximum water depths and water levels will be reported.

## Defining saving grid points

The Filter for Pipes and Canals group box is shown on the right side of the Location tab when the result is from a network model (i.e. Model Type = Network).

This section is used to select grid points along pipes and canals for which results are saved in the result file.

Filter for pipes and canals

Save

Chainage  [m]

The 'Save' dropdown list offers the following options:

- All grid points (no filter)
- Upstream grid point
- Downstream grid point
- Up- and downstream points
- Middle grid point
- User specified chainage. If 'User specified chainage' is selected, specify the grid point location for which results are saved in the 'Chainage' field below. Results are saved for the grid point closest to specified chainage value.

## Location of 2D maps

For the 2D map content type, the Location tab holds the following information to define the location and the resolution of the rectangular grid on which the 1D results are interpolated.



**Cell size:** The cell size of the dfs2 result file. The cell size controls the spatial resolution of the map.

**Rotation:** The rotation of the rectangular grid. The rotation is defined as the angle between true north and the Y-axis of the grid, measured clockwise. When a rotation is applied, the grid is rotated from its lower left corner, i.e. this corner remains at the same coordinates whereas the three other corners are moved.

**Extent definition:** This controls the way the extent of the map in the two spatial dimensions is defined. Two options are available:

- **Length:** with this option, you specify the width and height of the rectangle to define the dimensions along the two horizontal axes. MIKE+ will derive the extent of the file from the origo and these lengths.
- **Number of cells:** with this option, the user specifies the number of cells of the rectangular grid in the two spatial dimensions.

**Lower left corner:** The X coordinate (in the first column) and the Y coordinate (in the second column) of the lower left corner of the rectangular grid.

**Lengths:** The length of the grid along the X coordinate (in the first column) and along the Y coordinate (in the second column). These fields can be edited only when the extent is defined using the option 'Length'. When the extent is defined using the option 'Number of cells', the fields display the lengths which are automatically derived from the number of cells and the cell size.

**Number of cells:** Number of cells of the grid along the X coordinate (in the first column) and along the Y coordinate (in the second column). These fields can be edited only when the extent is defined using the option 'Number of cells'. When the extent is defined using the option 'Length', the fields display the numbers of cells which are automatically derived from the lengths and the cell size.

The grid may alternatively be defined by drawing the rectangle on the map using the 'Draw on map' button. This button activates the Map view: click and drag on the map to draw the rectangle. Use the icons on the map to move, resize or rotate the rectangle. Right-click on the map to finish editing. The 'Draw on map' button is renamed 'Edit on map' as soon as a grid has been defined.

Note that the grid is shown on the Map only while drawing. The grid is no longer shown on the map once editing is finished.



Location	Items	DEM input
Cell size	<input type="text" value="15"/>	[m]
Rotation	<input type="text" value="356.1276"/>	[deg] <input type="button" value="Edit on map"/>
Extent definition	<input type="text" value="Number of cells"/>	
	X axis	Y axis
Lower left corner	<input type="text" value="372247.3"/>	<input type="text" value="8127293"/>
Lengths	<input type="text" value="739.4095"/>	<input type="text" value="739.4095"/>
Numbers of cells	<input type="text" value="49"/>	<input type="text" value="49"/>

Figure 13.7 Defining the rectangular grid for a 2D map result file



Note: The results are mapped only within the extent of cross sections as illustrated in Figure 13.8.

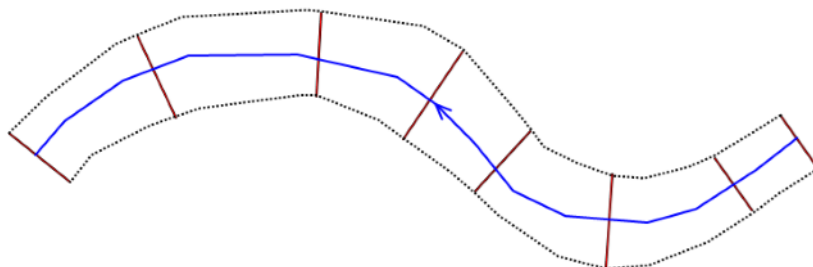

Figure 13.8 Illustration of area covered by the 2D map result, based on cross sections extent (red) and river line (blue).

No results will be mapped outside the cross sections extent, and the obtained maps will therefore represent exactly the extent of the flow during the 1D simulation.

An example of a flood map produced through the map-feature is presented in Figure 13.9.

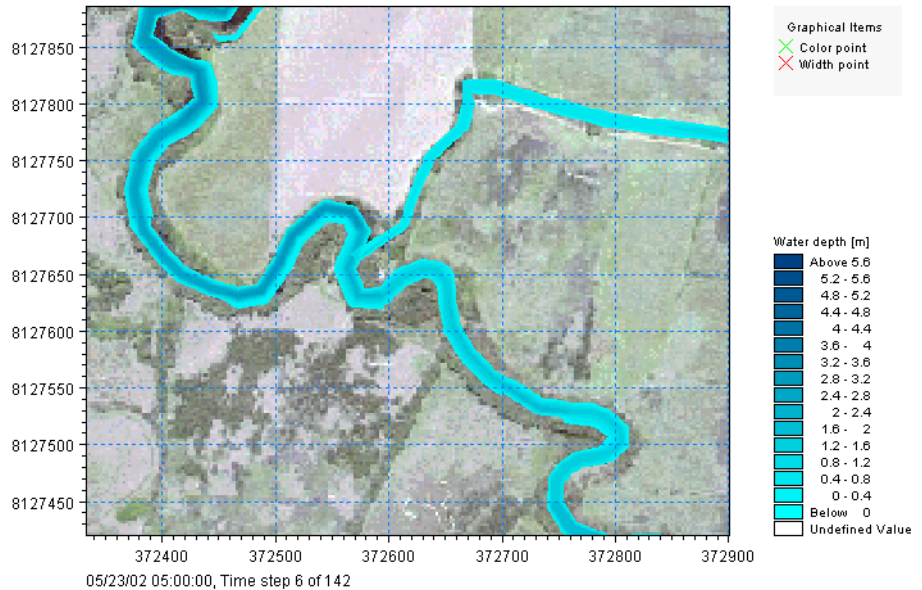

Figure 13.9 An example of a 2D flow map

### Save list / all but list

The 'Save list' and 'Save all but list' options are only available when saving network hydrodynamic results in a .dfs0 or .txt format.

The result file will respectively save all calculation points covered by the table, or all calculation points from the network except those covered by the table. The table is used to define a list of links (pipes or rivers) with upstream and downstream chainages encapsulating all calculation points between these two values.

Note that it is not possible to save these results in .dfs0 or .txt format in nodes or storages.

### 13.1.3 Format

When network hydrodynamic results are saved to .txt format, this tab is used to control the format of the created text file.



Location	Format	HD Items	AD Items	ST Items	ECO Lab
Data format					
Format		Additional statistical items			
<input checked="" type="radio"/> Column based		<input type="checkbox"/> Maximum			
<input type="radio"/> Table based		<input type="checkbox"/> Time of maximum			
Delimiter		<input type="checkbox"/> Minimum			
Column width		<input type="checkbox"/> Time of minimum			
Number of decimals					

Figure 13.10 The Format tab in the Result Files editor.

## Format

Two file formats are available:

- Column based: this will generate a text file with a column-based format. There will be one time column and one column for grid point item selected for output. The number of lines will equal the number of saved time steps.
- Table based: this will generate a text file with a table-based format. There will be one table for each time step saved. Each table will have rows corresponding to the number of selected grid points, and columns corresponding to the number of selected items.

## Delimiter

This controls the special character (e.g. semicolon, comma, etc.) to be used between each column.

## Column width

This is the desired minimum width of each column. The actual width in the created file will be larger if the content of the column doesn't fit in the minimum width.

## Number of decimals

The number of decimals written to the file, for result values.

## Additional statistical items

For each result item saved to the file, it is also possible to save some statistics, including:

- Maximum: a separate table at the bottom of the file will show the maximum value of the saved result items.
- Time of maximum: a separate table at the bottom of the file will show the time of maximum value of the saved result items.
- Minimum: a separate table at the bottom of the file will show the minimum value of the saved result items.
- Time of minimum: a separate table at the bottom of the file will show the time of minimum value of the saved result items.



### 13.1.4 Items

Tabs in the Result Files editor are used to select items that will be stored in the result file. Different tabs are shown depending on the Model Type and active project Modules.

Note that customising Items related to LIDs is currently not available. Also, modifying items related to MIKE ECO Lab results is done in the MIKE ECO Lab template (.ECOLAB) and not the MIKE+ interface.

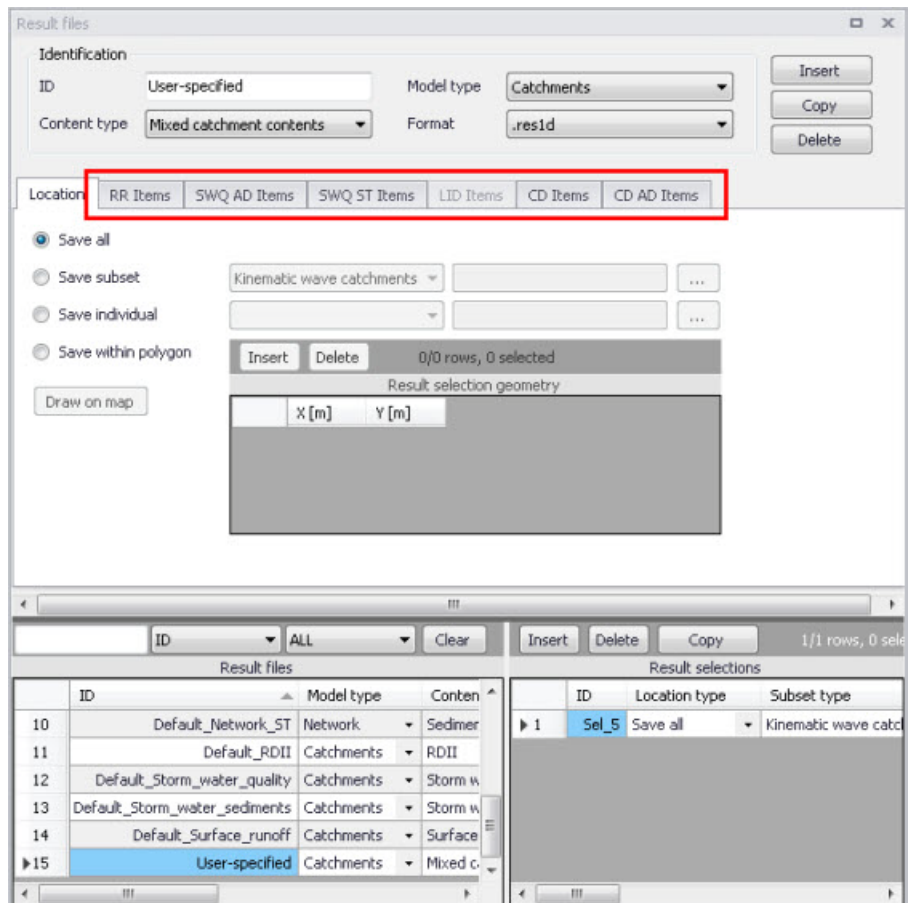

Figure 13.11 Item Tabs in the Result Files Editor. This figure shows available tabs for results from Catchment models.

Each tab shows items related to a computation Module, and the items are categorised as:

- Basic items. Primary result parameters for a simulated process.
- Additional items. Additional result items that provide greater detail on the simulated processes for the system.



The following sections describe the various result items available in MIKE+.

## RR Items (Surface runoff and RDI)

These are catchment rainfall-runoff modelling result items.

Table 13.4 summarises items that may be saved in surface runoff result files.

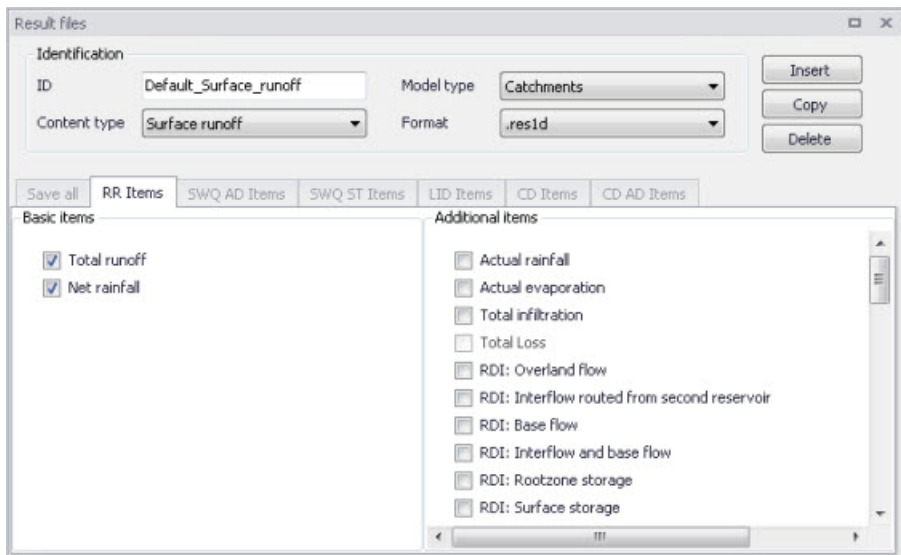

Figure 13.12 The RR Items Tab in the Result Files Editor. The 'Total runoff' and 'Net rainfall' items are initially included in Default Surface Runoff results.





Table 13.4 Overview of Surface Runoff result items in the RR Items Tab

Basic Items	Additional Items
Total runoff Net rainfall	Actual rainfall Actual evaporation Total infiltration RDI: Overland flow RDI: Interflow routed from second reservoir RDI: Base flow RDI: Interflow and base flow RDI: Rootzone storage RDI: Surface storage RDI: Groundwater depth RDI: Infiltration to groundwater RDI: Overland first reservoir flow, from first to second reservoir RDI: Interflow first reservoir flow, from first to second reservoir RDI: Capillary flux RDI: Overland first reservoir storage RDI: Overland second reservoir storage RDI: Lower base flow SnowStorage RDI: Snow ZoneTemperature RDI: Snow ZoneRainfall RDI: Snow ZoneWaterRetention RDI: Snow ZoneMeltingCoefficient RDI: Snow ZoneAreaCoverage RDI: Snow ZoneMeltingWater TimeArea: InitialLossStorage UHM: Excess Rainfall KW Runoff [ImperviousSteep, Flat] KW Runoff [PerviousSmall, Medium, Large] KW Depth [ImperviousSteep, Flat] KW Depth [PerviousSmall, Medium, Large] KW WettingLoss [PerviousSmall, Medium, Large] KW WettingLoss [ImperviousFlat] KW StorageLoss [ImperviousFlat] KW StorageLoss [PerviousSmall, Medium, Large] KW Infiltration [PerviousSmall, Medium, Large] KW InfiltrationPotential [PerviousSmall, Medium, Large]

### SWQ AD Items (Stormwater quality)

These are results related to the modelling of water quality of stormwater from catchments.

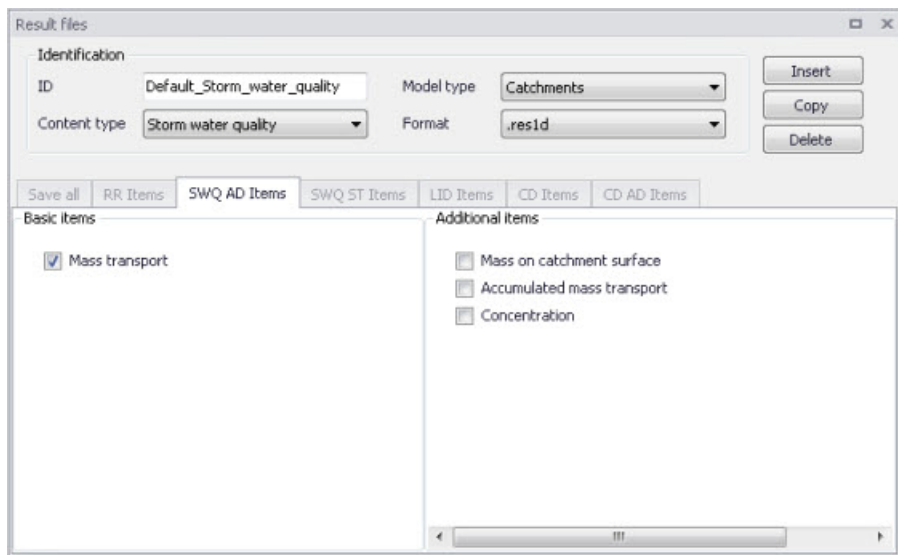

Figure 13.13 The SWQ AD Items Tab in the Result Files Editor. The 'Mass transport' item is initially included in Default Stormwater Quality results.

Table 13.5 Overview of Stormwater Quality result items in the SWQ AD Items Tab

Basic Items	Additional Items
Mass transport	Mass on catchment surface Accumulated mass transport Concentration

### SWQ ST Items (Stormwater sediments)

These are results related to the modelling of sediment transport with stormwater over catchments.

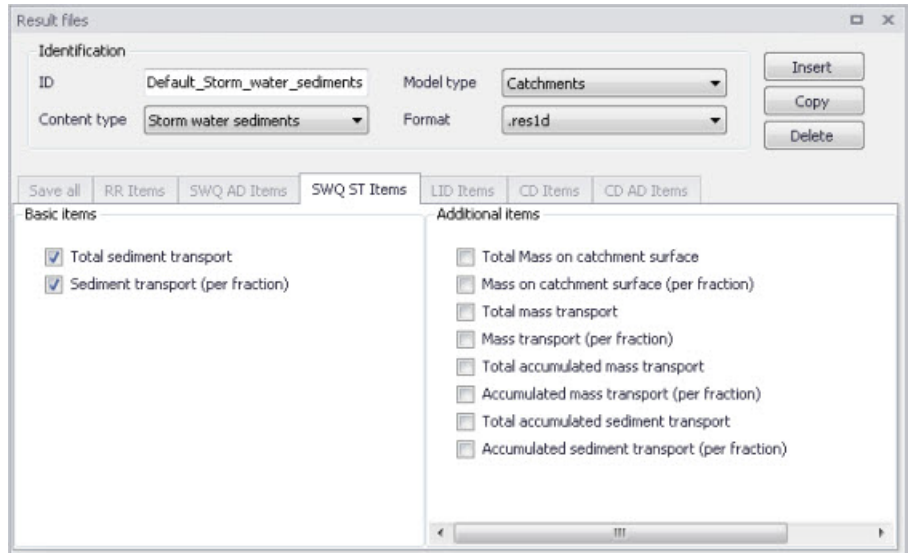

Figure 13.14 The SWQ ST Items Tab in the Result Files Editor. The 'Total sediment transport' and 'Sediment transport (per fraction)' items are initially included in Default Stormwater Sediments results.

Table 13.6 Overview of Stormwater Sediments Transport result items in the SWQ ST Items Tab

Basic Items	Additional Items
Total sediment transport Sediment transport (per fraction)	Total Mass on catchment surface Mass on catchment surface (per fraction) Total mass transport Mass transport (per fraction) Total accumulated mass transport Accumulated mass transport (per fraction) Total accumulated sediment transport Accumulated sediment transport (per fraction)

### LID Items

It is currently not possible to customise result items for LID results in MIKE+. All result items are saved by Default. Table 13.7 shows the LID result items from a catchment model saved in .DFS0 format.



Table 13.7 Overview of LID result items

Basic Items	Additional Items
Rain Inflow Surface Flow Drain Flow Infiltration	Evaporation Surface Depth Soil Moisture Storage Depth Surface to Soil Soil to Storage Drain Storage Depth (Green Roof) Soil to Drain Storage (Green Roof) Pavement Moisture (Porous pavement) Surface to pavement (Porous pavement) Pavement to Storage (Porous pavement) Mass Checksum

Please refer to the 'LID Deployment Result File' section under the 'Rainfall-Runoff Modelling' chapter in this Collection System User Guide for more details on the LID result items listed above.

## CD Items (Catchment discharge)

Catchment discharge consists of person equivalent (PE)-based or area-based inflows from catchments (e.g. wastewater inflows).

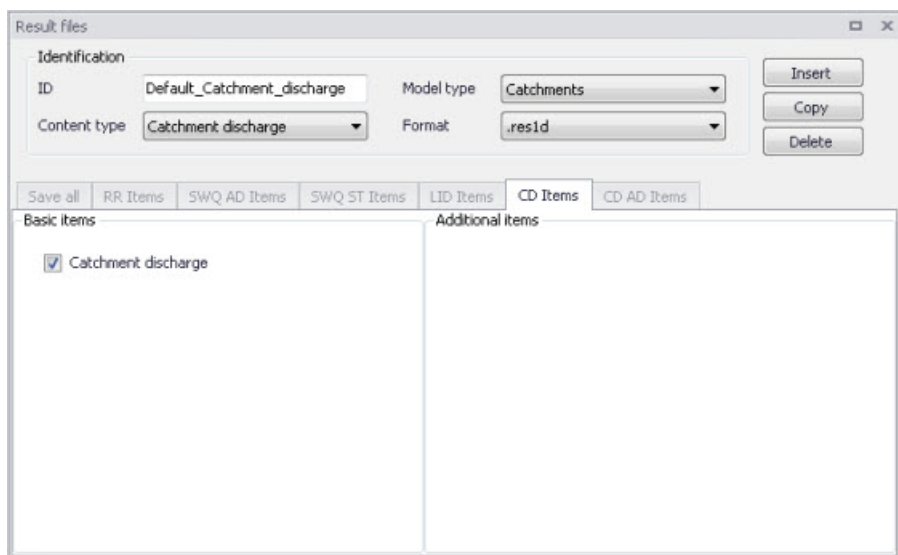

Figure 13.15 The CD Items Tab in the Result Files Editor. The 'Catchment discharge' item is initially included in Default Catchment Discharge results.



## CD AD Items (Catchment discharge quality)

These are computational items related to the modelling of pollutant transport with catchment discharge.

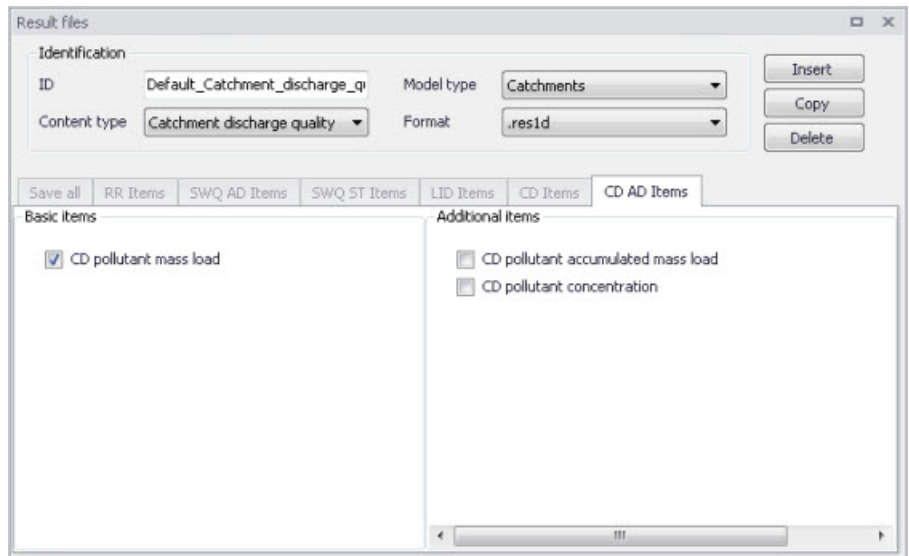

Figure 13.16 The CD AD Items Tab in the Result Files Editor. The 'CD pollutant mass load' item is initially included in Default Catchment Discharge Quality results.

Table 13.8 Overview of Catchment Discharge Quality result items in the CD AD Items Tab

Basic Items	Additional Items
CD pollutant mass load	CD pollutant accumulated mass load CD pollutant concentration

## HD Items

These are result items related to hydrodynamic calculations in the network, including items related to control rules.

Some additional items related to control rules (setpoint value, pump start level, pump stop level) are always saved even though they are not listed in this tab, because they are essential in case the result file is to be used as hot-start file.

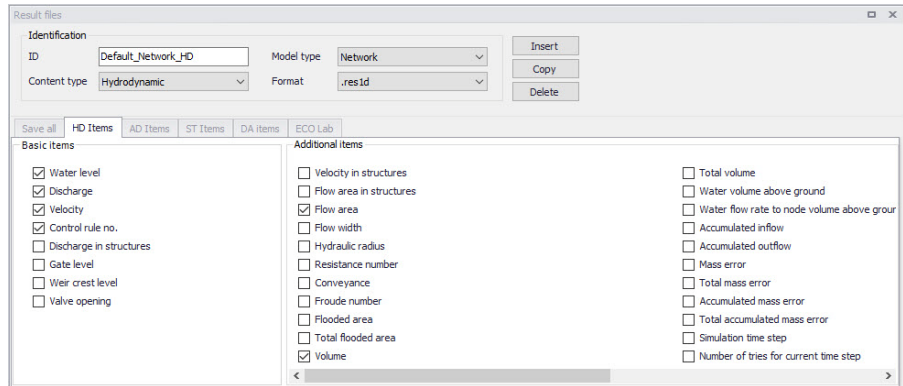

Figure 13.17 The HD Items Tab in the Result Files Editor.



Note: Some result items are not available when saving to .txt file format, and are therefore disabled.

### AD Items (Pollution transport)

These are result items related to the modelling of the transport of pollutants in the sewer network.

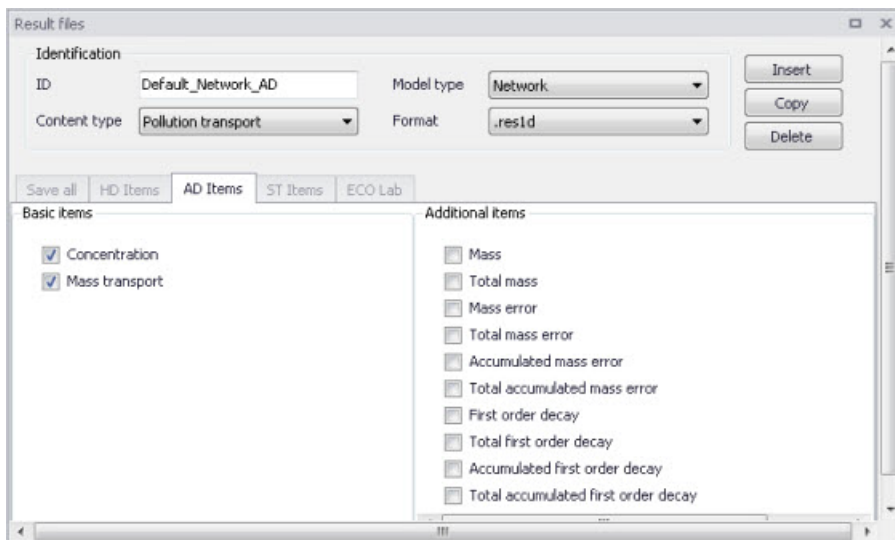

Figure 13.18 The AD Items Tab in the Result Files Editor. The ‘Concentration’ and ‘Mass transport’ items are initially included in Default Pollution Transport results.

Table 13.9 Overview of pollution transport items in the AD Items tab

Basic Items	Additional Items
Concentration Mass transport	Mass Total mass Mass error Total mass error Accumulated mass error Total accumulated mass error First order decay Total first order decay Accumulated first order decay Total accumulated first order decay



Note: if the Decay is set to 0 for a component, the decay-related result items which are not relevant for this component are never saved to the result file. That means that decay-related result items are saved only for WQ components with decay different than 0.

### ECO Lab (MIKE ECO Lab water quality)

These are the result items from the MIKE ECO Lab simulation. The 'MIKE ECO Lab template' group on the left shows the list of templates included in the project. Select one of the templates to access the selection of result items for this template.

The 'Basic items' group in the center shows the list of state variables and derived outputs from the selected template.

The 'Additional items' group on the right shows the list of auxiliaries and processes from the selected template.

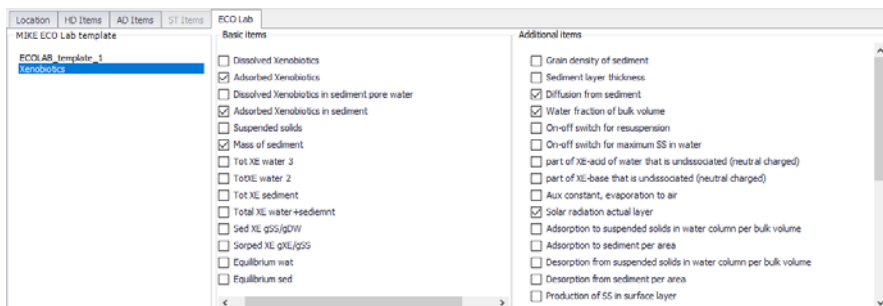

Figure 13.19 The MIKE ECO Lab items in the 'Result files' editor.

Note that these lists depend on the State Variables, Auxiliary Variables, Processes and Derived Outputs defined in the MIKE ECO Lab template used in the simulation (Figure 13.20). This template can only be edited in the MIKE ECO Lab editor, in MIKE Zero.

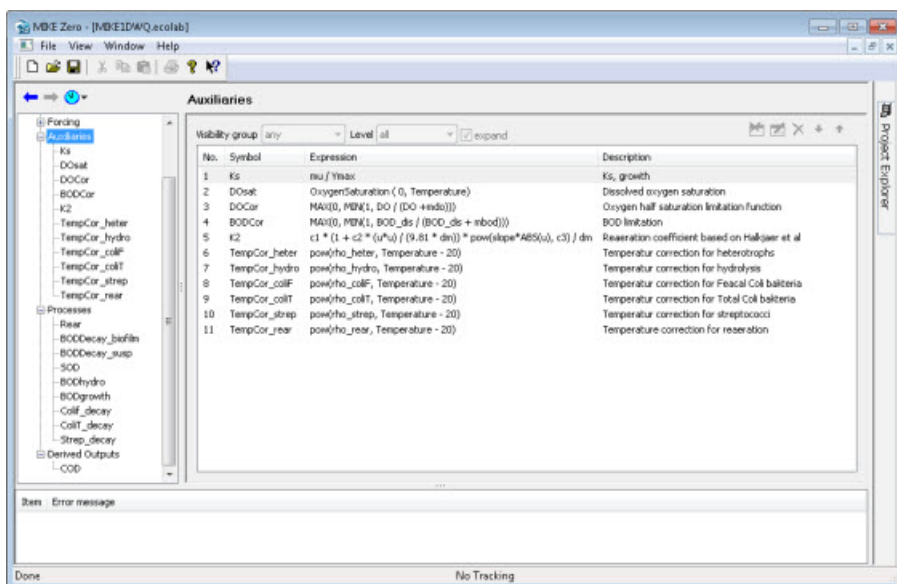

Figure 13.20 Example MIKE ECO Lab template (\*.ECOLAB) showing the Auxiliaries, Processes, and Derived Outputs sections





## LTS HD Items (LTS extreme and chronological statistics)

These are LTS statistics results related to LTS hydrodynamic modelling in sewer networks.

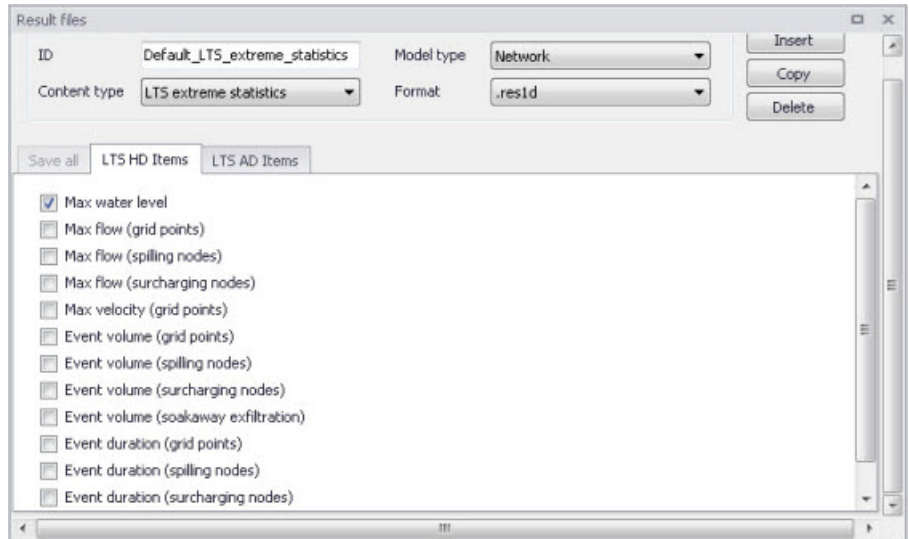

Figure 13.21 The LTS HD Items Tab in the Result Files Editor. The figure shows pre-selected items for Default LTS Extreme Statistics results.



Table 13.10 Overview of items in the LTS HD Items Tab related to LTS Extreme and Chronological Statistics Results

Extreme Statistics	Chronological Statistics
Max water level	Total accumulated volume (out of the system)
Max flow (grid points)	Total accumulated volume (outlet pipes)
Max flow (spilling nodes)	Total accumulated volume (pumps out of the system)
Max flow (surcharging nodes)	Total accumulated volume (weirs out of the system)
Max velocity (grid points)	Total accumulated volume (orifices out of the system)
Event volume (grid points)	Total accumulated volume (valves out of the system)
Event volume (spilling nodes)	Total accumulated volume (spilling nodes)
Event volume (surcharging nodes)	Accumulated spilled volume (spilling nodes)
Event volume (soakaway exfiltration)	Accumulated surcharge volume (nodes)
Event duration (grid points)	Accumulated exfiltration volume (soakaways)
Event duration (spilling nodes)	Accumulated volume (discharge)
Event duration (surcharging nodes)	
Event duration (soakaway exfiltration)	

### LTS AD Items (LTS extreme and chronological statistics)

These are LTS statistics results related to LTS modelling of pollution transport in sewer networks.

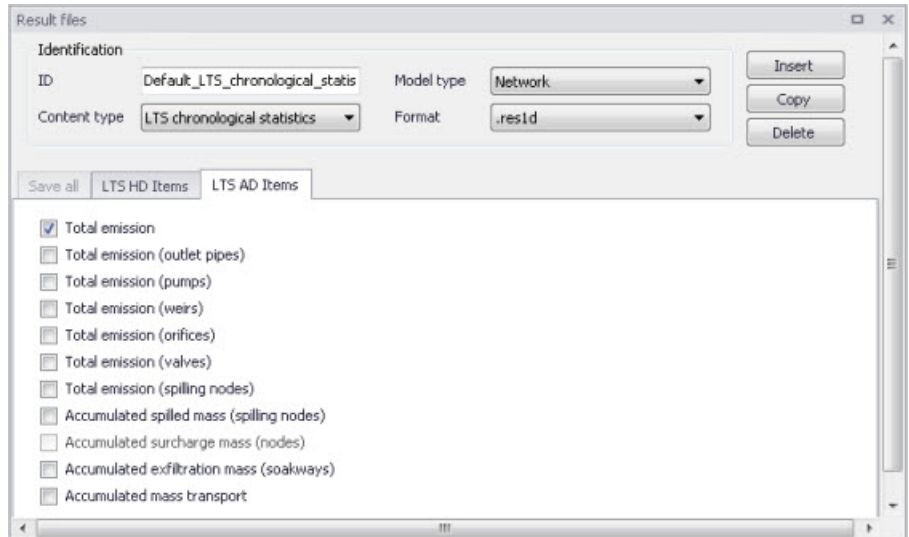

Figure 13.22 The LTS AD Items Tab in the Result Files Editor. The figure shows pre-selected items for Default LTS Chronological Statistics results.

Table 13.11 Overview of items in the LTS AD Items Tab related to LTS Extreme and Chronological Statistics Results

Extreme Statistics	Chronological Statistics
Max concentration	Total emission
Event load (grid points)	Total emission (outlet pipes)
Event load (spilling nodes)	Total emission (pumps)
Event load (surcharging nodes)	Total emission (weirs)
Event load (soakaway exfiltration)	Total emission (orifices)
	Total emission (valves)
	Total emission (spilling nodes)
	Accumulated spilled mass (spilling nodes)
	Accumulated surcharge mass (nodes)
	Accumulated exfiltration mass (soakways)
	Accumulated mass transport

### DA Items (Data assimilation)

These are the result items related to Data assimilation calculations. Some result items are only applicable with the DA mode 'Updating with Kalman filter'. Some result items are applicable with the DA modes 'Updating with Kalman filter' and 'Uncertainty prediction'. The DA mode 'Updating with weighting function' does not create specific result items, but only affects the



regular result items (e.g. water level and discharge), so the 'DA items' tab is not relevant for this mode.

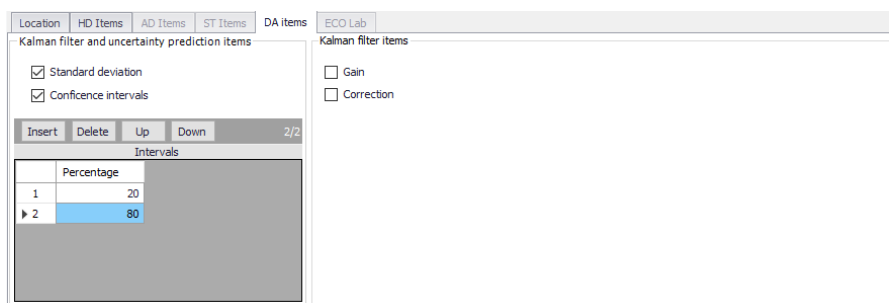

Figure 13.23 The DA Items tab in the Result Files editor.

Confidence interval result item requires specification of a percentage value for each confidence interval. Percentage values are defined in the table located below the 'Confidence intervals' check box.

Note that DA results are always saved to a separate result file, with a suffix (e.g. `_HDStat.res1d`).

## 2D map items

This controls the item being mapped in a result file with content type '2D map'. Only one item can be mapped in each file.

Various results items may be mapped:

- **Water level:** this option creates a map of water level. The water level is assumed to be constant along the cross sections, and is then interpolated in the longitudinal direction.
- **Water depth:** this option creates a map of water depth, being the difference between the above water level and the interpolated bed level. This bed level can optionally be defined by a DEM, and is otherwise defined by the cross sections.
- **Velocity:** with this option, the velocity is recomputed based on the water depth in each cell of the grid.
- **Velocity \* depth:** this provides a derived result computed as velocity times depth.
- **DEM:** this option generates a digital elevation model (DEM) for the river bed, based on the topography from the cross sections and the river direction.



- Depth and fluxes (h, p, q): this option produces a file containing the three items Water depth, P-flux and Q-flux. This map type is primarily used to display flow vectors (using the fluxes information) on top of the water level or depth.
- WQ component: this option creates a map of the concentration of the selected component.

Please refer to the MIKE 1D reference manual for details about the mapping procedure.

Besides, three types are available:

- Maximum: the overall maximum value throughout the simulation period for each cell included in the map.
- Minimum: the overall minimum value throughout the simulation period for each cell included in the map.
- Dynamic: time-varying map able to animate the results.

Item	Type
<input checked="" type="radio"/> Water level	<input type="radio"/> Maximum
<input type="radio"/> Water depth	<input type="radio"/> Minimum
<input type="radio"/> Velocity	<input checked="" type="radio"/> Dynamic
<input type="radio"/> Velocity * depth	
<input type="radio"/> DEM	
<input type="radio"/> Depth and fluxes (h, p, q)	
<input type="radio"/> WQ component	

compA ...

Figure 13.24 Selecting the result item for a 2D map result file

### 13.1.5 DEM input

An additional option while generating 2D maps of water depth is to include ground level information from external DEM files. In that case, the water levels are mapped to the DEM to compute the water depth, instead of interpolating the ground levels from the cross sections.

To include this option, activate the 'Use input DEM' box.

One or more Digital Elevation Model files must then be supplied in the table. Items are added or removed using the 'Insert' and 'Delete' buttons above the table. The use of multiple DEM files is intended to support multiple DEM tiles to cover the entire area: in that case all the tiles can be supplied in the table, with no need to merge them in a single file. If some files overlap, the topography in the overlapping area will be defined by the first DEM in the list.



Note: The list of DEMs is shared by all 2D map result files i.e., editing the list of DEMs for one 2D map result file will also update any other 2D map result file.

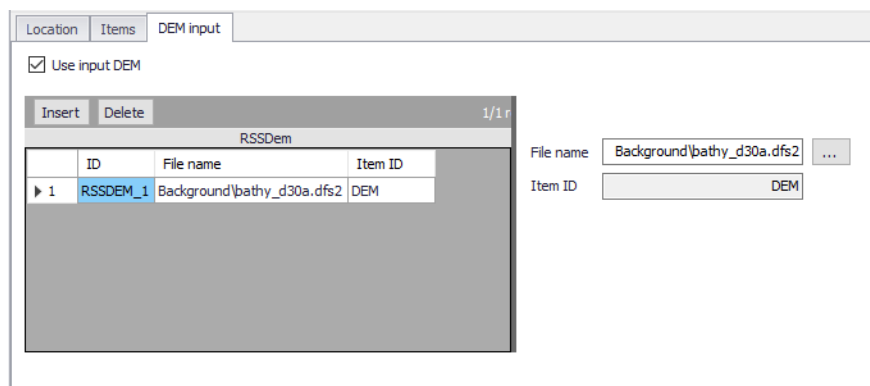

Figure 13.25 The optional list of DEMs for 2D map result files

### 13.1.6 Combining various result items in one file

MIKE+ offers high flexibility in configuring result files obtained from simulations. The secondary table (Figure 13.26) in the Result Files editor is used to specify different combinations of items and locations for user-specified result setups.

User-specified results (i.e. non-Default) may be configured to contain different result sets with varying combinations of:

- Location
- Items. Items may be from the same Content Type or from across different (active) Content Types.

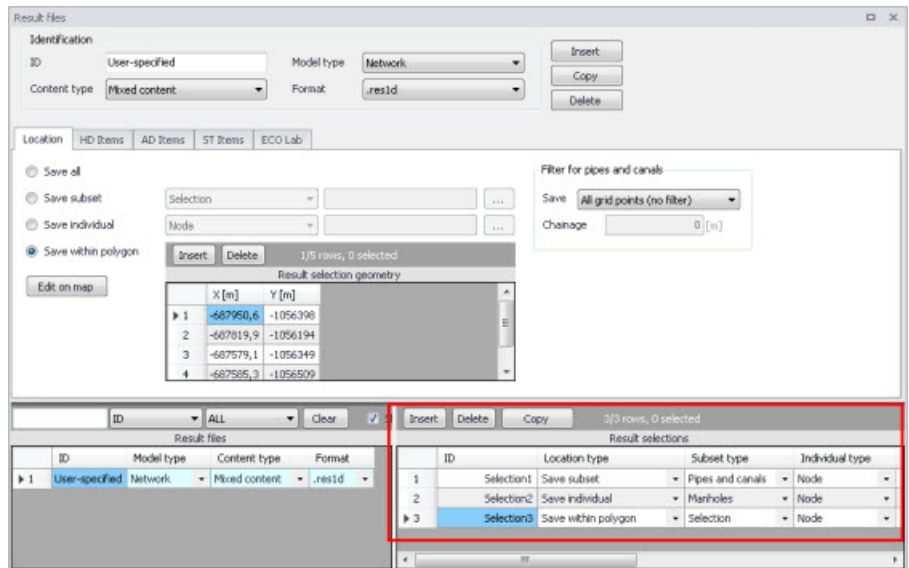

Figure 13.26 The secondary table in the Result Files Editor

The example shown in Figure 13.26 is a 'Network' result file setup that has 'Mixed content' and includes 3 Location-Items combinations in one .RES1D result file. Result items from across content types (i.e. active modules) may also be saved in one file. Use Content Type = 'Mixed content' for the result file setup to allow this option (see example in Figure 13.26).

The Location-Item combinations are as the example are summarised in the table below:

Table 13.12 Example Location-Items combinations from across content types that may be combined in one Mixed Content User-Specified result file

Result	Location	Items
Selection1	Save subset = Pipes and canals	HD Items = Water level, Velocity
Selection2	Save individual = Node 7	AD Items = Concentration
Selection3	Save within polygon	HD Items = Discharge

The content of the secondary table is controlled with the following buttons:

**'Insert' button**

Creates a new item in the table, with Default properties.

**'Delete' button**

Deletes the current selected rows from the secondary table.

### 'Copy' button

Creates a copy of the active row.

## 13.2 Network Summary

The basic contents of HTML summaries generated at the end of simulations may be customised in MIKE+. Various Network Summary configurations may be defined through the Network Summary editor (Result Specifications | Network Summary) (see Figure 13.28). These configurations may then be invoked in the Simulations Setup editor when running Network (HD) simulations.

The basic HTML summary shows information on the simulation, overall results summary, and boundary inputs. Adding a network summary configuration will extend the basic summary with the 'HD Results Summary' section (Figure 13.27).

MIKE ID Computation Engine 2019

Index  
[Simulation Type](#)  
[File Overview](#)  
[Time Overview](#)  
[HD Summary](#)  
[Boundary Connections](#)  
[HD Results Summary](#) →

Simulation Type

Type	Method
HD	Fully 3D

File Overview

Working Directory  
 C:\Users\mikeadmin\Documents\LTS

Main input file

File name	Last modified
TutorLTS.mvwp	29-03-2019

Main output files

File name	Last modified	Directory
TutorLTSBaseDefault_Network_HD_res1d	29-03-2019 08:12:05	.

HD Results Summary

Nodes - Water level

Notes  
 G: Max level exceeds ground level  
 C: Max level exceeds critical level

Node ID	Minimum [m]	Maximum [m]	Ground Level [m]	Ground Level - Maximum [m]	Time of Minimum	Time of Maximum	Note
A0.0327	16,50	16,50	17,20	0,70	03-01-1936 01:26:10	03-01-1936 01:26:10	C
B4.1200	16,80	17,16	19,90	2,74	03-01-1936 01:26:10	02-02-1936 17:25:44	
B4.1300	17,43	17,55	19,90	2,35	03-01-1936 01:26:10	02-02-1936 17:25:44	
B4.1310	17,31	17,40	20,23	2,83	03-01-1936 01:26:10	02-02-1936 17:27:45	
B4.1320	17,11	17,20	20,20	3,00	03-01-1936 01:26:10	02-02-1936 17:42:23	
B4.1480	16,50	16,52	18,50	1,98	03-01-1936 17:30:08	02-02-1936 17:46:54	
B4.1485	16,50	16,64	19,80	3,26	06-01-1936 15:00:45	02-02-1936 17:46:54	
B4.1490	16,50	16,67	19,80	3,13	06-01-1936 15:07:04	02-02-1936 17:46:00	

Figure 13.27 Example network simulation HTML summary augmented with an additional HD result summary table for Nodes.

Additional items may be activated for each network summary setup in the editor. The Network Summary editor is organized into the following groups:

- Identification
- Tables with min, max and accumulated values for
- Summary of input data





- Use selection to reduce summary tables

Activate the various options on the editor to customise additional contents for the network simulation HTML summary. An overview of the various options in the editor is shown in Table 13.13.

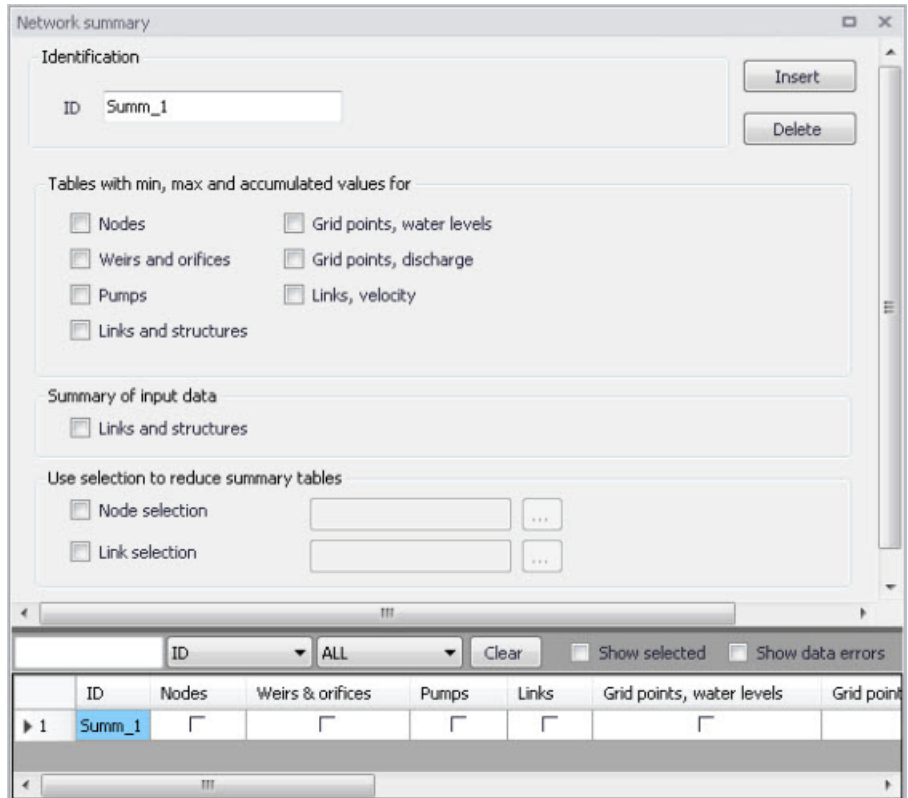

Figure 13.28 The Network Summary Editor

Table 13.13 Overview of the Network Summary editor attributes (Table msm\_Html-Summary)

Edit field	Description	Used or required by simulations	Field name in datastructure
ID	ID of summary- user specified	Yes	MUID
Nodes checkbox	Activate to include tables with min, max and accumulated values in the summary	Optional	SummaryNodeNo



Table 13.13 Overview of the Network Summary editor attributes (Table msm\_Html-Summary)

Edit field	Description	Used or required by simulations	Field name in datastructure
Weirs and orifices checkbox	Activate to include tables with min, max and accumulated values in the summary	Optional	SummaryWeirNo
Pumps checkbox	Activate to include tables with min, max and accumulated values in the summary	Optional	SummaryPumpNo
Links and structures checkbox	Activate to include tables with min, max and accumulated values in the summary	Optional	SummaryLinkNo
Grid points, water levels checkbox	Activate to include tables with min, max and accumulated values in the summary	Optional	SummaryLinkLevelNo
Grid points, discharge checkbox	Activate to include tables with min, max and accumulated values in the summary	Optional	SummaryLinkDischargeNo
Links, velocity checkbox	Activate to include tables with min, max and accumulated values in the summary	Optional	SummaryLinkVelocityNo
Summary of input data, Links and structures checkbox	Activate to include a summary of input data in the HTML summary	Optional	SummaryLinkInputNo
Node selection file checkbox	Activate to specify nodes for which to include tables with min, max and accumulated values in the summary	Optional	NodeSelectionNo
Node selection input box	Input box for specifying the Node selection list	Yes If NodeSelectionNo=1	NodeSelection-Name



Table 13.13 Overview of the Network Summary editor attributes (Table msm\_Html-Summary)

Edit field	Description	Used or required by simulations	Field name in datastructure
Link selection file checkbox	Activate to specify links for which to include tables with min, max and accumulated values in the summary	Optional	LinkSelectionNo
Link selection input box	Input box for specifying the link selection list	Yes If LinkSelectionNo=1	LinkSelectionName

Use the following button functions on the editor to add or remove network summary setups for the project:

**‘Insert’ button**

Adds a new Network Summary setup in the editor.

**‘Delete’ button**

Removes the active/selected Network Summary setup from the editor.





## 14 Scenarios

The water distribution and wastewater collection data models are commonly used for the system performance analysis and in the planning process. The complexity of the involved systems, the various uncertainties about the future conditions and usually huge costs associated with maintenance, rehabilitation and development necessitate a thorough investigation of alternative system configurations in a search for the technically feasible, environmentally sound and economically efficient solution. These alternative configurations - scenarios - may differ by the system's physical layout, loading conditions, operational strategies, etc. Various projects, such as development of a Sewerage Master Plan, Wastewater Transportation Strategy, an Overflow Abatement Strategy, etc. would typically result in a large number of scenarios, either representing alternative system configurations at a given time and/or representing the system at various development stages. Test of each scenario against the prescribed legislation or the standards of service that the authorities provide requires a numerical model on its own.

These scenarios are always related to each other through the common origin ('Base') and the differences typically epitomize a smaller part of the total data. Moreover, scenarios representing a development of the system through time are subject to the dependencies propagating along with the timeline. Analysis of the scenarios as separate projects creates major inconveniences, such as:

- Large number of models, even when differences between them are minor
- Missing the efficient overview over the entire set of solutions
- Inability to maintain the existing dependencies between the individual scenarios automatically. Thus, the updating of the models with additional information requires editing of multiple files to change the same element, e.g. if a pipe diameter is found to have been incorrectly registered in the GIS database, it will have to be updated multiple times in each of the scenario project files.

### 14.1 What are Scenarios

The MIKE+ Scenarios is a user interface for a set of MIKE URBAN+ features, enabling the definition, organisation management and reporting of alternative scenarios, such as:

- Augmentation of existing trunk sewer mains;
- Increased wastewater loading from increased population;
- Increased water demands from increased population;
- Alternative design loads, e.g. rainfall-runoff of different return period;
- Alternative alignment of sewer and storm mains;



- Building of a new sewer trunk and water supply mains in order to cater for a new development area within the same MIKE+ project.

## 14.2 Design of the MIKE+ Scenario Manager

The MIKE+ Scenario group is based on the concept of Data Groups, Alternatives and Scenarios. In this context, a Data Group is a set of database tables which form a meaningful set. E.g. all database tables containing collection system network data belong to the data group 'Network Data'. Every database table relevant for the scenario manager is included in one of the Data Groups.

Each Data Group can appear in the MIKE+ project in any number of Alternatives. The initial alternative is named with a default name 'Base'. Any further alternative is created upon user request and gets a user-specified name. The Alternatives for a certain data group are organised in a tree-like structure, where dependencies propagate along the branches -from the 'parent' to all the 'heirs' i.e. 'children'.

A scenario represents a complete set of consistent data, featuring the system configuration for a given situation. In other words, a scenario contains one alternative of each Data Group. Actually, individual alternatives are used as building blocks for constructing scenarios. A moderate number of data groups (eight for collection system and nine for water distribution) allows for a manageable structure of scenarios, while ensuring the high level of flexibility.

The initial scenario is named with a default name 'Base', and consists of the 'Base' alternative of each data group. Any further scenario is created upon user request and gets a user-specified name. The scenarios are organised in a tree-like structure of 'parents' and 'children'.

### Alternatives

The alternatives represent the components of the scenarios. The various alternatives contain the actual data belonging to a certain data group. Actually, each subsequent alternative only contains the information on the differences relative to its immediate 'parent', while the rest of data is inherited from the 'parent' through the principles of inheritance.

Grouping of various alternatives belonging to different data groups into scenarios is sometimes subject to limitations, because the data groups have not been formed on the basis of data independency, but rather following the logical data grouping. E.g. the alternative of the 'Catchment connections' CS data group, which specifies a catchment connection to node 'A', cannot be used with the alternative of the 'Network data' data group where node 'A' has been renamed or deleted. Obviously, the catchment would remain disconnected.



## Collection System Alternatives

For Collection Systems, the scenarios are composed of the following data groups:

- CS network data
- River network data
- Loads and Boundaries data
- Catchment & Hydrology data
- Transport data
- Control rules data
- Long term statistics data
- Profiles and Curves
- 2D Overland

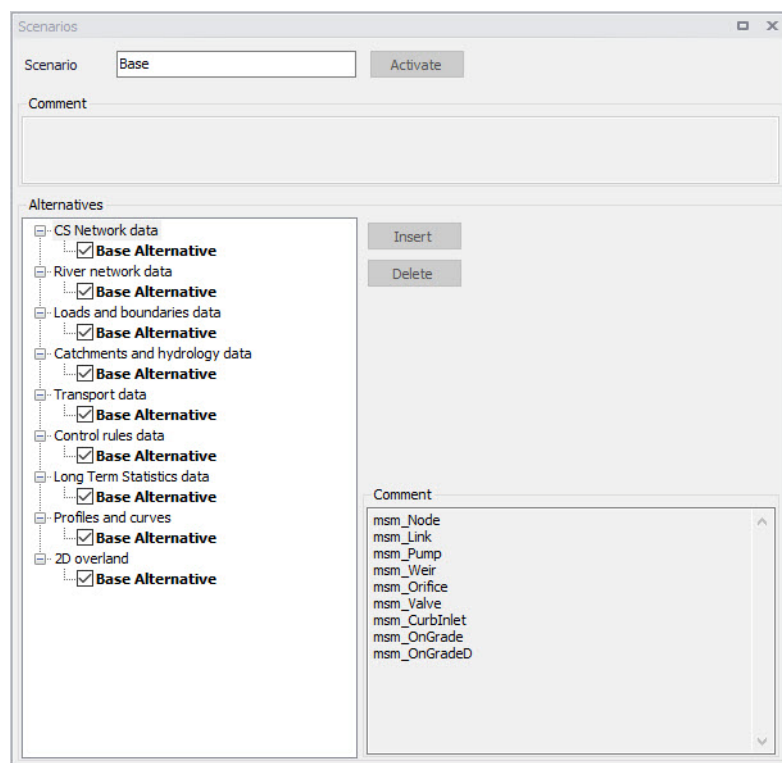

Figure 14.1 Scenarios Alternatives for Collection System

## Water Distribution Alternatives

For Water Distribution Systems input data can be grouped the following way, corresponding to the different types of available alternatives:

- Network
- Water Demands
- Control
- Water Quality
- Pattern and Curves

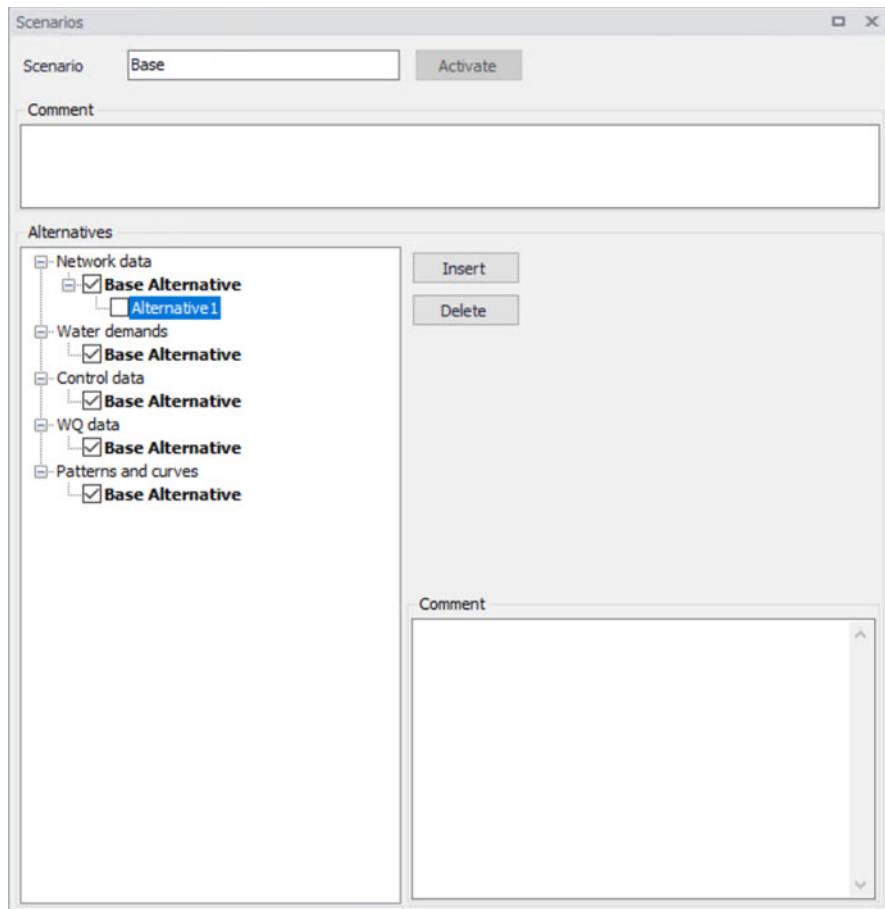

Figure 14.2 Scenarios Alternatives for Water Distribution

## Inheritance principles

With the inheritance from 'parent' alternatives to 'child' alternatives, some specific items must be kept in mind.





- Making a change to an alternative will affect all descendent ('child') alternatives of that alternative. This means that it will impact all the scenarios where either the alternative or the children of that alternative are applied. This also ensures that if one value needs updating it will be updated in all the scenarios where the alternative is applied (e.g. if a pipe diameter is found to have been incorrectly registered in the GIS data during the course of a project then the pipe diameter can be changed one place only, regardless of the number of scenarios and alternatives that reference to this alternative).
- The chain of inheritance for a certain data record stops where any change (or delete) of that element has occurred in earlier work. E.g. if a bottom level of a node 'A' has been edited in some child alternative, some later update of the bottom level in 'Base' will only propagate through the alternative tree until the alternative containing the old change.
- Adding an element (e.g. a node) in the 'parent' with an ID that already exists in one or more of its descendants ('children') will overwrite the content of the 'child' element
- If adding an element (e.g. pump/link) in the parent that cannot be added to all the children (because some parts may have been deleted/changed there), the element is added where possible and omitted elsewhere.

## 14.3 Managing Scenarios and Alternatives

The Scenario Manager has two parts:

- The Scenario part
- The Alternatives part

The scenario part is for creating, editing and managing scenarios, while the alternatives part is for creating, editing and managing alternatives.

Under Scenarios in the tree view one can “right-click” to get the option of creating a new child scenario.

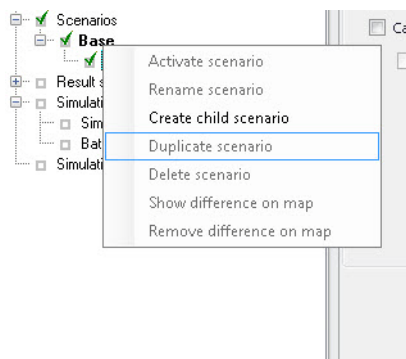

Figure 14.3 Create a new child scenario

Right-clicking on a child scenario enables the options to activate, rename, duplicate, delete, create a new child scenario and visualize the differences in the map.

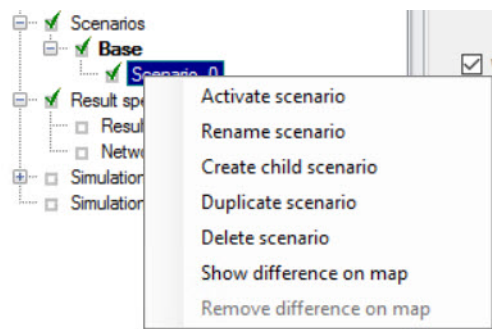

Figure 14.4 Management of child scenarios

## Scenarios

The scenario part is used for creating, editing, and managing scenarios. Per default there will one built-in scenario, i.e. the Base scenario. The Base scenario cannot be edited or deleted. An unlimited number of additional scenarios can then be added to cover the various 'What if' scenarios.

### Create a Child Scenario

This option adds a scenario that is a child of the highlighted (not to be confused with the active/current scenario), i.e. to begin with the alternatives of a new scenario will be that of the highlighted scenario. A name for the new scenario is suggested by default. The name can be changed through the option of Rename scenario or by editing directly in the ID field in the Scenario editor.

### Remove

The remove option will delete the highlighted scenario. The Base scenario cannot be deleted. Note that deleting a scenario will not delete any data as



the alternatives hold the data (the scenarios just refer to alternatives). The comments for the scenario being deleted, however, will also be deleted.

### Rename

The rename option will make the scenario name active so it can be easily renamed.

### Activate

The activate button will load the scenario, i.e. the project data is manipulated so that all editors contain the appropriate data. Depending on the size of the project this may take some time.

### Alternatives

Alternatives can be edited only if the appropriate scenario is made active. Alternatives can, however, be added regardless of the active scenario. When a scenario is loaded, the project data is manipulated so that all editors contain the appropriate data.

Alternatives can be activated, inserted and deleted in the editor through the visual buttons.

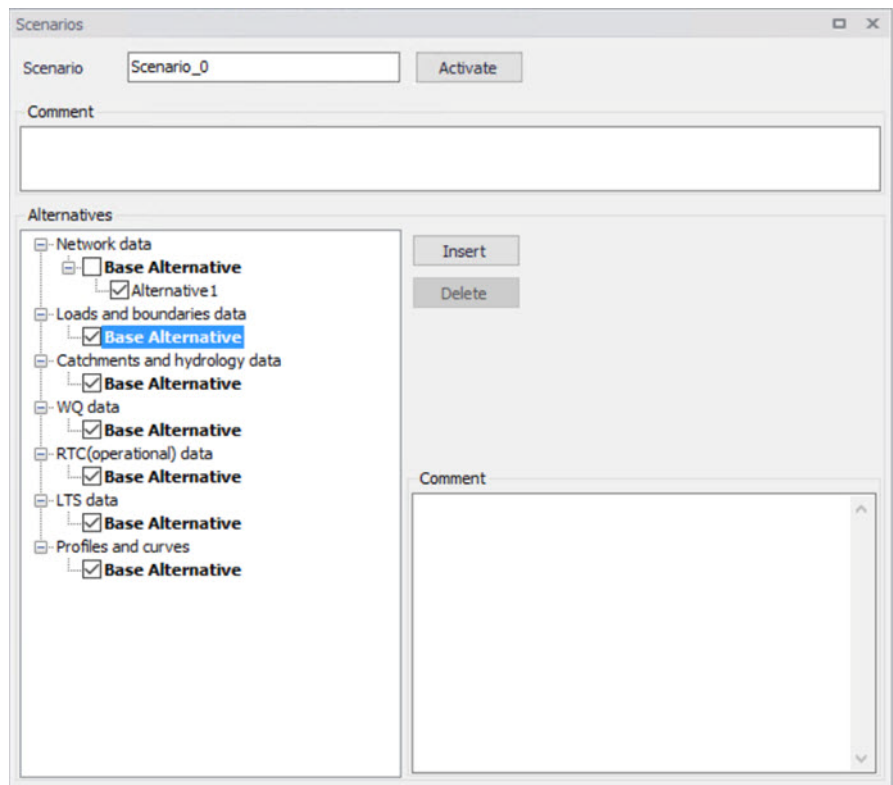

Figure 14.5 Alternative options



## 14.4 How to Start Working with Scenarios

### Creating alternatives and scenarios

- Right click on Scenario in the Tree view
- Create a child scenario
- Select the alternative group that you wish to add an alternative to and press the 'Insert' button
- You can now rename it and/or continue to make alternatives
- Select the alternative and click on Activate

The activated scenario is displayed in bold font. Equally, all the alternatives belonging to the active scenario, are displayed in bold in the 'Alternatives' page.

Both the data tables, the graphics and any MIKE+ tools work **ONLY** with the data belonging to the currently active scenario. Access to the data belonging to other scenarios is not possible through MIKE+ interface.



## 15 Simulation Specifications

MIKE+ simulations are started from the Simulation Specifications section. This section includes the following menus:

- **Simulation Setup.** Where various combinations of different types of simulations may be setup and run.
- **Batch Simulation.** Controls batch simulations involving the automatic sequential launch of several simulation jobs.

### 15.1 Simulation Setup

The Simulation Setup editor has several tabs, which are shown depending on the active features and modules for the project:

- **General.** Includes general parameters, such as definition of the simulation period, selection of simulation types, and free text description of the simulation setup.
- **Catchments.** Includes parameters specific for Runoff simulation.
- **HD.** Includes parameters specific for HD simulation.
- **AD and WQ.** Includes parameters specific for network AD simulation and MIKE ECO Lab.
- **LTS.** Includes parameters specific for Network LTS simulation.
- **Results.** Includes specification of results (output) to be generated by the simulation.

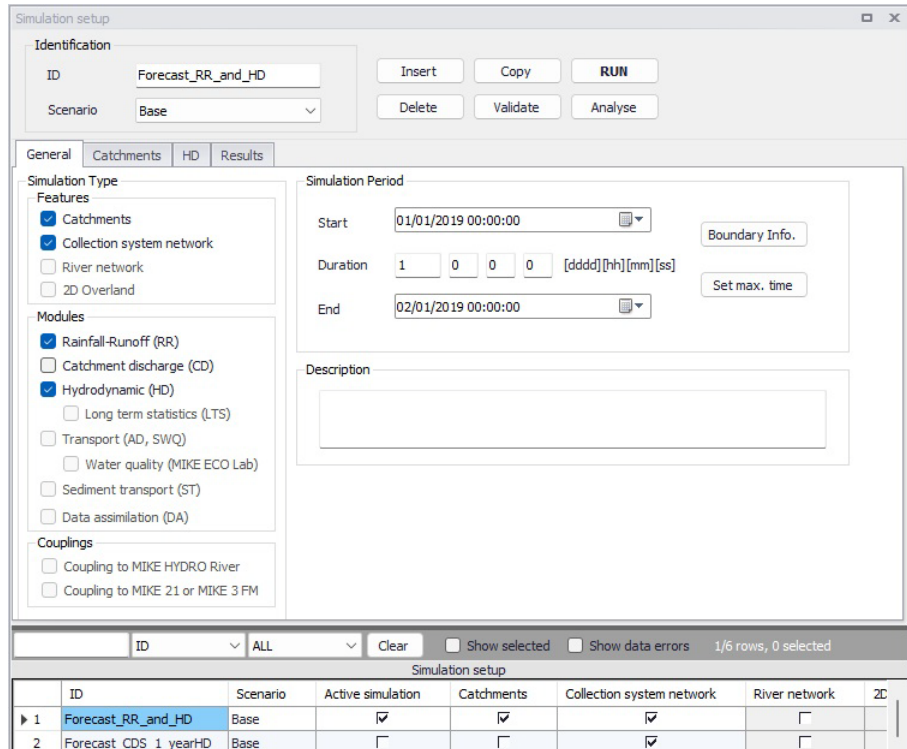

Figure 15.1 The Simulation Setup Editor

The Identification group at the top and the scrollable grid table at the bottom of the editor are common across all tabs.

Table 15.1 Overview of the Simulation Setup Identification data group (Table msm\_Project)

Edit field	Description	Used or required by simulations	Field name in datastructure
ID	User-specified ID of simulation. ID will be reflected in the name of result files	Yes	MUID



Table 15.1 Overview of the Simulation Setup Identification data group (Table msm\_Project)

Edit field	Description	Used or required by simulations	Field name in datastructure
Scenario	Dropdown menu for selecting ID of Scenario for the simulation	Yes	ScenarioName
Active simulation check box	Defines a simulation setup as "in the tray", i.e. as the one chosen among simulation setups to be used when extracting data by external application, e.g. MIKE FLOOD, and for running directly from the Simulation toolbar. Only one job at a time may be set as "Active".	Yes	ActiveProject

The following buttons are also located at the top of the editor with the Identification group:

#### 'Insert' button

Inserts a new record in the Simulation Setup editor with a default ID.

#### 'Copy' button

Duplicates an existing (currently active) simulation setup record.

#### 'Delete' button

Deletes a currently active simulation record.

#### 'RUN' button

Triggers export of the current simulation job and execution of the simulation.

#### 'Validate' button

MIKE+ employs automatic validation, checking for data errors as one navigates through the various editors. However, one may also collectively check the consistency of the MIKE+ project data through the validation of the simulation. Press the 'Validate' button to open the validation window:

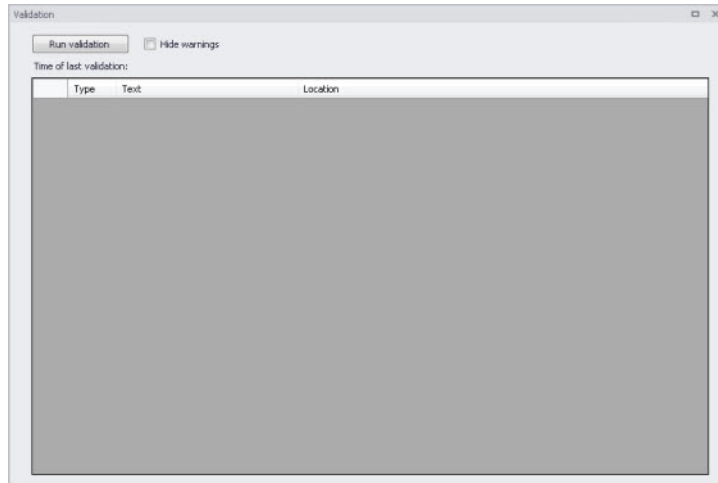

Figure 15.2 The Simulation Validation window

The validation applies to the simulation set as 'Active simulation' in the 'Simulation setup' editor. From this window, press the 'Run validation' button to start the data validation and see the list of warnings and errors in the table. The validation time depends on the database size, number of active modules and number of errors found.

A description of the warning or error is included in the 'Text' column in the list. The description usually indicates the data type or editor in which the error should be corrected.

Type	Text	Location	validation
Error	CRS of type H/W has H values that are not increasing. CRS ID: 'GREENHALL_C'	None	571
Error	CRS of type H/W has H values that are not increasing. CRS ID: 'GREENHALL_C'	None	571
Error	CRS of type H/W has H values that are not increasing. CRS ID: 'GREENHALL_C'	None	571
Error	CRS of type H/W has H values that are not increasing. CRS ID: 'GREENHALL_C'	None	571
Error	CRS of type H/W has H values that are not increasing. CRS ID: 'GREENHALL_C'	None	571
Error	CRS of type H/W has H values that are not increasing. CRS ID: 'GREENHALL_B'	None	575
Error	CRS of type H/W has H values that are not increasing. CRS ID: 'GREENHALL_B'	None	575
Error	CRS of type H/W has H values that are not increasing. CRS ID: 'GREENHALL_B'	None	575
Error	CRS of type H/W has H values that are not increasing. CRS ID: 'GREENHALL_B'	None	575
Error	CRS of type H/W has H values that are not increasing. CRS ID: 'GREENHALL_B'	None	575
Error	CRS of type H/W has H values that are not increasing. CRS ID: 'GREENHALL_B'	None	575
Error	CRS of type H/W has H values that are not increasing. CRS ID: 'Greenwell_C'	None	580
Error	CRS of type H/W has H values that are not increasing. CRS ID: 'Greenwell_C'	None	580
Error	CRS of type H/W has H values that are not increasing. CRS ID: 'Greenwell_C'	None	581
Warning	The reach with ID '37RAID001' has no cross section at start channel. The cross section with the lowest change will be ...	None	582
Warning	The reach with ID 'Greve_220801' has no cross section at end channel. The cross section with the highest change will ...	None	583
Warning	The reach with ID 'Greve_450401' has no cross section at end channel. The cross section with the highest change will ...	None	584
Warning	The reach with ID 'Greve_536801' has no cross section at end channel. The cross section with the highest change will ...	None	585
Warning	The reach with ID 'Greve_561301' has no cross section at start channel. The cross section with the lowest change will ...	None	586
Warning	The reach with ID 'HILLDAED_160901' has no cross section at end channel. The cross section with the highest change ...	None	587
Warning	The reach with ID 'HILLDAED_61401' has no cross section at end channel. The cross section with the highest change ...	None	588
Warning	The reach with ID 'IschoerSoell' has no cross section at end channel. The cross section with the highest change will b...	None	589
Warning	The reach with ID 'KARLSRUHE_351701' has no cross section at end channel. The cross section with the highest change ...	None	590
Warning	The reach with ID 'KARLSRUHE_351701' has no cross section at end channel. The cross section with the highest change ...	None	591
Warning	The reach with ID 'Karl_222401' has no cross section at end channel. The cross section with the highest change will b...	None	592
Warning	The reach with ID 'Karl_222401' has no cross section at end channel. The cross section with the highest change will b...	None	592

Figure 15.3 The validation list indicates whether an item is an Error (highlighted in red) or a Warning (highlighted in yellow).





It is possible to activate the 'Hide warnings' option to only show errors without warnings in the list.

### 'Analyse' button

This button opens a tool that can be used to find elements of a river or CS network that may be contributing to instabilities during an HD simulation. The tool produces a list of h-points ranked according to one of the three following criteria, all ranked from smallest to largest:

- Time step required to achieve a specified stability criterion
- Surface area
- Length

Analysis settings

Show locations with:

Smallest time step for stability based on water depth

Water depth definition: User-defined global value

Global water depth value: 1 [m]

Courant number (stability criterion): 0.85 [0]

Smallest surface area at H-points

Water depth definition: User-defined global value

Global water depth value: 1 [m]

Smallest length at H-points

Ordered list

Number of elements in table: 5

Order	Time step [sec]	Zoom	Link ID	Chainage [m]
1	0.46287814611547834	Zoom	River	1306.5
2	0.63708289424223641	Zoom	River	202.5
3	0.65805761797386131	Zoom	River	146
4	0.75339720401236254	Zoom	River	1302
5	1.0189165526074258	Zoom	River	188

Generate list Close

Figure 15.4 The Analyse network tool.

More information about the three options is provided below.

#### *Time step required to achieve a specified stability criterion*

When using this option, the tool finds the time step needed to achieve a specified Courant number for each h-point. This option can be used to find an appropriate time step for a stable simulation or identify parts of the model net-



work that should be streamlined to enable a stable simulation at a longer time step.

Because the Courant number evaluation depends on the depth of water, a depth definition must be provided. Four options are available:

- User-defined global value: single value applied throughout network.
- Full-running pipe or river (min. of markers 1 and 3): for rivers, this option uses the minimum of markers 1 and 3 as water level in each cross section. A full-running pipe is used for collection system modelling.
- Full-running pipe or river (min. of markers 4 and 5): for rivers, this option uses the minimum of markers 4 and 5. If markers 4 and 5 are not defined, then the minimum of markers 1 and 3 is used. A full-running pipe is used for collection system modelling.
- Initial conditions: Water depth definitions are taken from the initial conditions specification.

#### *Surface area*

Under this option, the tool computes the surface area associated with each h-point, in other words the surface area from the upstream Q-point to the downstream Q-point (or from the calculation point to the nearest upstream or downstream Q-point, if the calculation point is located at the start or end of a river branch).

A depth is needed to compute a surface area. The same four options are available as for 'Time step required to achieve a specified stability criterion'.

For rivers, the area is calculated assuming a constant width equal to the width of the cross-section at the specified depth. For collection system modelling, the area is calculated using a very small width corresponding to a pipe that is almost full. The flow area criterion is not particularly useful for analysis of pipes.

#### *Length*

Under this option, the tool computes the length associated with each h-point, in other words the length from the upstream Q-point to the downstream Q-point (or from the calculation point to the nearest upstream or downstream Q-point, if the calculation point is located at the start or end of a river).

### 15.1.1 General

The General tab includes parameters relevant for the entire simulation setup. The following parameters are specified in the General tab:

- Simulation type
- Simulation period



- Description

Figure 15.5 The Simulation Setup Editor General tab

An overview of the editor fields and corresponding database attributes is provided in Table 15.2 below.

Table 15.2 Overview of the Simulation Setup General tab attributes (Table msm\_Project)

Edit field	Description	Used or required by simulations	Field name in datastructure
Catchments	Activates catchment-related simulation types	Yes	Enable_Catchment
Collection system network	Activates CS related simulation type	Yes	Enable_CS
River network	Activates river related simulation type	Yes	Enable_River
2D Overland	Activates 2D related simulation types	Yes	Enable_2DOverland
Rainfall-Runoff (RR)	Activates runoff simulation	Yes	Enable_RR
Catchment Discharge (CD)	Activates catchment discharge computations	Yes	Enable_CD
Hydrodynamic (HD)	Activates HD simulations for CS, Rivers and/or 2D overland	Yes	Enable_HD



Table 15.2 Overview of the Simulation Setup General tab attributes (Table msm\_Project)

Edit field	Description	Used or required by simulations	Field name in datastructure
Long Term Statistics (LTS)	Activates LTS simulation	Yes	ENable_LTS
Transport (AD, SWQ)	Activates AD simulations for CS, Rivers and/or 2D overland and/or SWQ simulations for catchments	Yes	Enable_AD
Water quality (MIKE ECO Lab)	Activates MIKE ECO Lab simulations for CS, Rivers and/or 2D overland	Yes	Enable_ECOLAB
Sediment Transport (ST)	Activates CS network sediment transport simulation	Yes	Enable_ST
Data Assimilation (DA)	Activates DA network update simulation	Yes	Enable_DA
Coupling to MIKE HYDRO River	Activates coupling to MIKE HYDRO River. HD coupling is always activated. AD coupling is activated if Transport (AD,SWQ) module is also activated.	Yes	Enable_MHRiver_Coupling
Coupling to MIKE 21 or MIKE 3 FM	Activates coupling to MIKE 21 FM or MIKE 3 FM.	Yes	Enable_M21FM_Coupling
Start	Specifies start date and time for the simulation.	Yes	ComputationBegin
Duration	Displays the duration of the simulation in days, hours, minutes and seconds. Automatically adjusted based on Start and End time/date. May be edited, adjusting End date/time accordingly.	Yes	-



Table 15.2 Overview of the Simulation Setup General tab attributes (Table msm\_Project)

Edit field	Description	Used or required by simulations	Field name in datastructure
End	Specifies end date and time for the simulation. Adjusted automatically according to user's specification of duration.	Yes	ComputationEnd
Description	Free text description of the simulation setup	Optional	Description

### 'Boundary Info.' button

The Boundary Info. button opens the Boundary Overview window with a horizontal bar chart showing time extent of all active boundary conditions from all included modules.

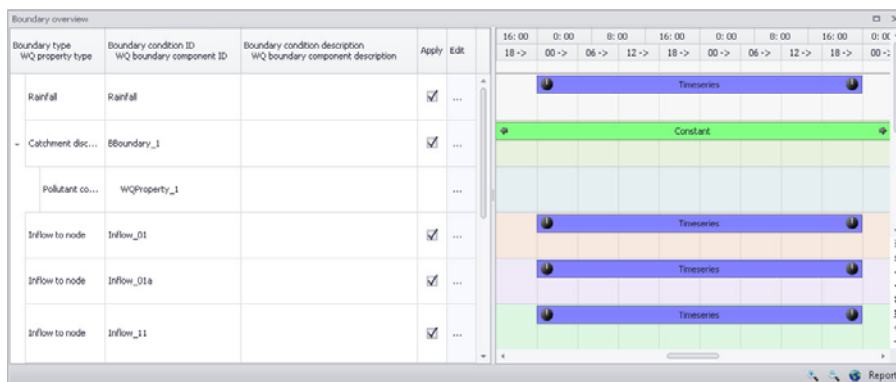

Figure 15.6 The Boundary Overview appears when pressing the 'Boundary Info.' button

### 'Set max. time' button

The 'Set max. time' button sets the maximum simulation time by filling in the start and end times of the simulation. The start time of a simulation is considered the latest start time of all boundaries. Likewise the end time for the simulation is considered the earliest end time of all boundaries.

Each boundary contains a number of items which can cover different parts of the simulation.

If a limited validity interval is specified for a boundary condition, this specifies the start and end time. If a validity is not specified, only items specified as



timeseries have a start and end time. If either a constant or cyclic value is given without validity interval, the item is not included in the evaluation.

### 15.1.2 Catchments

The following parameters can be specified on the Catchments tab:

- Surface runoff model simulation time step
- RDI simulation time step
- Catchment discharge simulation time step
- Spatial distribution of rainfall
- RDI hotstart specification
- Additional parameters specification

The screenshot displays the 'Catchments' tab in the simulation setup software. It is organized into several sections:

- Time step:**
  - Surface runoff models:** Time-Area (900 [sec]), Kin. wave (60 [sec]), UHM (60 [sec]).
  - Linear reservoir:** Wet weather (60 [sec]), Dry weather (300 [sec]).
  - Continuous hydrological model:** RDI (4 [h]).
  - Catchment discharge:** 3600 [sec].
- Spatial distribution of rainfall:**
  - Distribution type: Closest rain gauge (dropdown).
  - Power parameter: 2.
  - Maximum search radius: 50 [km].
- RDI hotstart:**
  - Apply (button).
  - Use simulation start time. RDI hot start time: - (dropdown).
- Additional parameters:**
  - Apply (button).

Figure 15.7 The Simulation Setup Catchments Tab



Table 15.3 The Simulation Setup Catchments tab attributes (Table msm\_Project)

<b>Edit field</b>	<b>Description</b>	<b>Used or required by simulations</b>	<b>Field name in datastructure</b>
Time-Area	Fixed time step for Time-Area runoff model	Yes if at least one catchment is set for simulation with Time-Area model	TSDt
Kin. Wave	Fixed time step for Kinematic Wave runoff model	Yes if at least one catchment is set for simulation with Kinematic Wave model	KWDt
UHM	Time step for UHM model	Yes if at least one catchment is set for simulation with UHM runoff model	UHMDt
Wet weather	Time step during wet periods	Yes if at least one catchment is set for simulation with Linear Reservoir runoff model	DtWetPeriod
Dry weather	Time step during dry periods	Yes if at least one catchment is set for simulation with Linear Reservoir runoff model	DtDryPeriod
RDI	RDI slow runoff component time step. The fast runoff component time step is the corresponding surface runoff model time step.	Yes if at least one catchment is set for simulation with RDI runoff model	SRCDt
Catchment Discharge	Time step for catchment discharge	Yes if Catchment Discharge simulation active	CDDt



Table 15.3 The Simulation Setup Catchments tab attributes (Table msm\_Project)

Edit field	Description	Used or required by simulations	Field name in datastructure
Distribution type	<p>When rainfall boundary conditions are defined with the geographical location of the rain station (boundary type 'Data source location'), it is possible to control how the rainfall intensity from the various rain gauges (boundary conditions) are applied to the different catchments. Three methods are available: assign the closest rainfall time series to each catchment, apply weighting using Thiessen polygons, or apply weighting using an inverse distance interpolation. Weights can be reviewed in the 'Boundary conditions' editor.</p>	Yes, if rainfall boundary conditions are of spatial extent type 'Data source location'	DistribTypeNo
Power parameter	The power coefficient, in the inverse distance interpolation equation.	Yes, when the distribution type is set to 'Inverse distance weighting'.	Power
Maximum search radius	The maximum distance for searching rainfall stations, in the inverse distance interpolation equation.	Yes, when the distribution type is set to 'Inverse distance weighting'.	SearchRadius
RDI Hotstart Apply checkbox	If this checkbox is ticked, a hotstart file for RDI must be specified.	Optional	RDHotStartNo





Table 15.3 The Simulation Setup Catchments tab attributes (Table msm\_Project)

Edit field	Description	Used or required by simulations	Field name in datastructure
Use simulation start time	If 'Use simulation start time' option is enabled, the initial condition is automatically extracted from the hotstart file using the simulation start date and time as specified in the 'Simulation Setup' editor.	Optional	RDIHotStart-TimeUseNo
RDI hotstart time	The date and time at which the initial conditions are loaded from the hotstart file. Only active if 'Use simulation start time' option is inactive.	Optional	RDIHotStartTime
Additional Parameters Apply checkbox	If this checkbox is ticked, an *.ADP file for the runoff simulation can be specified	Optional	ADPRunoffFileNo

The additional parameter file (\*.ADP file) is a separate file with additional settings for the simulation. Please refer to the separate documentation on this file for further information.

### 15.1.3 HD

For a network (CS network and/or river network) simulation, the tab holds parameters specific to the hydrodynamic simulation setup:

- Fixed simulation time step, or
- Adaptive simulation time step settings
- Network initial condition type
- Additional parameters

For a simulation including 2D overland, the time step parameters are changed to:



- A fixed simulation time step, used by the network simulation. This time step is also used to determine the saving frequency of 2D overland result files, and to synchronize the HD and AD modules for the 2D overland simulation.
- Adaptive time step settings, applying only to the 2D overland simulation.

The tab is active if a hydrodynamic (HD) module is activated and if relevant data exist in the project (e.g. if at least 1 conduit is specified).

The screenshot shows the 'HD' tab of the 'Simulation Setup Editor'. It contains three main sections: 'Time Step', 'Network initial conditions', and 'Additional Parameters'. In the 'Time Step' section, the 'Fixed' radio button is selected, with a value of '1 [sec]'. The 'Adaptive' radio button is unselected, but its sub-section is visible, showing 'Minimum' at '0.01 [sec]', 'Maximum' at '1 [sec]', and 'Max. increase factor' at '1.3'. In the 'Network initial conditions' section, the 'Type' dropdown is set to 'Empty network', and the 'Initial conditions ID' field is empty. In the 'Additional Parameters' section, the 'Apply' checkbox is unchecked, and the field below it is empty.

Figure 15.8 HD Tab of the Simulation Setup Editor

For network simulations, the initial condition definition may be of the following types:

- Empty network: with this option, the network will be empty at the first time step of the simulation, except at outlet nodes where water levels from possible boundary conditions will propagate into the network.
- User-specified: with this option, a set of initial conditions must be selected. Sets of initial conditions contain definition of default values, local values, and hotstart files. They are defined in the 'Initial conditions' editor.



- **State file:** with this option, initial conditions for all modules included in the simulation (Hydrodynamic, Rainfall-runoff, Transport, etc.) are obtained from a state file, which is a detailed result file from a previous simulation. It is therefore required that state files have been saved during a previous simulation (see 13.1.1 Identification (*p.* 420)). For this type of initial condition, it is required to provide a path to the folder containing the state files created from the previous simulation, along with a date and time controlling which time step (i.e. which state file) will be used as initial condition. The appropriate state file from the selected folder, with the date and time the closest to the specified instant, will be selected automatically during the simulation. If 'Select state file using simulation start time' is ticked, the state file with the date and time the closest to the simulation start date will automatically be selected, otherwise the state file with the date and time the closest to the user-defined date and time will be used. A set of 'Initial conditions ID' must also be selected: initial conditions from the state file have the highest priority, but if the network has e.g. been extended and some calculation points do not exist in the state file, the initial conditions in these points will be controlled by the user-defined initial conditions.
- **Steady state:** with this option, initial conditions will be based on a steady state calculation for all rivers in the model, except for locations where local user-defined values are defined in the optional user-defined 'Initial conditions ID'. Default values and hotstart files defined in the selected 'Initial conditions ID' are ignored. This option is not supported for collection system networks.

Table 15.4 The Simulation Setup HD tab attributes (Table msm\_Project)

Edit field	Description	Used or required by simulations	Field name in datastructure
Fixed/Adaptive radio buttons	Toggles between alternative time step type	Yes	HDDtStepType
Fixed	Specifies a fixed time step for the network simulation	Yes if Fixed time step type or if including 2D overland	HDDtFixed
Minimum	Specifies a minimum time step for network or 2D overland model	Yes if Adaptive time step type or if including 2D overland	HDDtMin
Maximum	Specifies a maximum time step for network or 2D overland model	Yes if Adaptive time step type or if including 2D overland	HDDtMax



Table 15.4 The Simulation Setup HD tab attributes (Table msm\_Project)

Edit field	Description	Used or required by simulations	Field name in datastructure
Max. Increase Factor	Specifies maximum increase factor for adaptive time step for network model	Yes if Adaptive time step type	HDDtIncreaseFactor
Max. CFL number	Specifies the expected maximum CFL number in the simulation, to control the adaptive 2D overland time step	Yes if including 2D overland	M2DHDMaxCFL
Network initial conditions type	Specifies the type of initial condition for the network (CS and/or river)	Yes if including CS network or River network simulation	HDInitCondTypeNo
Initial conditions ID	Specifies the ID of the set of initial conditions, defined in the 'Initial conditions' page	Yes except if defined as 'Empty network'	HDInitCondID
State files folder	The path to the folder containing the state files saved during a previous simulation	Yes if 'State file' is chosen	StateFilesFolder
Select state file using simulation start time	If selected, the simulation will use the state file with date and time matching the start time of the simulation.	Yes if 'State file' is chosen	UseSimulationTypeNo
Date and time	The user-defined date and time to select the state file from all state files saved during a previous simulation	Yes if 'Select state file using simulation start time' is not chosen	StateStartTime
Additional Parameters Apply checkbox	Activates *.ADP file with network-relevant input. Define *.ADP file name and path if activated.	Optional	ADPNetworkFileNo

The additional parameter file (\*.ADP file) is a separate file with additional settings for the simulation. Please refer to the separate documentation on this file for further information.



### 15.1.4 AD and WQ

The "AD and WQ" tab includes parameters specific for the AD and MIKE ECO Lab (WQ) simulation setup. The tab is available if the Transport (AD, SWQ) module is activated in the 'General' tab, otherwise it is hidden.

Figure 15.9 The Simulation Setup AD and WQ Tab

Table 15.5 The Simulation Setup AD and WQ tab attributes (Table msm\_Project)

Edit field	Description	Used or required by simulations	Field name in datastructure
Minimum	Specifies a minimum time step for 2D overland model	Yes if including 2D overland	M2DADDtMin
Maximum	Specifies a maximum time step for 2D overland model	Yes if including 2D overland	M2DADDtMax
Max. CFL number	Specifies the expected maximum CFL number in the AD simulation, to control the adaptive 2D overland AD time step	Yes if including 2D overland	M2DADMaxCFL



Table 15.5 The Simulation Setup AD and WQ tab attributes (Table msm\_Project)

Edit field	Description	Used or required by simulations	Field name in datastructure
Type	Controls whether the simulation start with an empty network (no component) or with pre-defined initial conditions	Yes	ADInitContTypeNo
AD initial condition ID	The ID of the selected set of Network AD initial conditions	Yes if Type = User-specified	ADInitCondID
Decoupling of HD and AD simulations	Decoupling a transport simulation (AD or WQ) from the HD simulation speeds up the simulation by getting the hydrodynamic conditions from a decoupled result file, instead of running the HD simulation at the same time. This is especially relevant when running multiple transport simulations with identical HD conditions.	Yes	DecouplingADHD-TypeNo
Decoupling file	The decoupled result file to be used as input for the decoupled transport simulation. It is a result file with content type 'Decoupling' which must be saved during a previous simulation.	Yes, if 'Run transport simulation using decoupling file' is chosen	DecouplingPath
MIKE ECO Lab Integration	Specified ECO Lab integration method	Yes If Simulation Type = MIKE ECO Lab (WQ)	ELIntegrationNo
Time step multiplier	Multiplier used to scale the MIKE ECO Lab time step as a function of the HD time step	Yes	ELUpdateFrequency



## 15.1.5 LTS

The LTS tab includes parameters specific for Network LTS simulations. The tab is shown if the Long Term Statistics (LTS) module is activated in the project and if at least 1 Job List Criterion is specified.

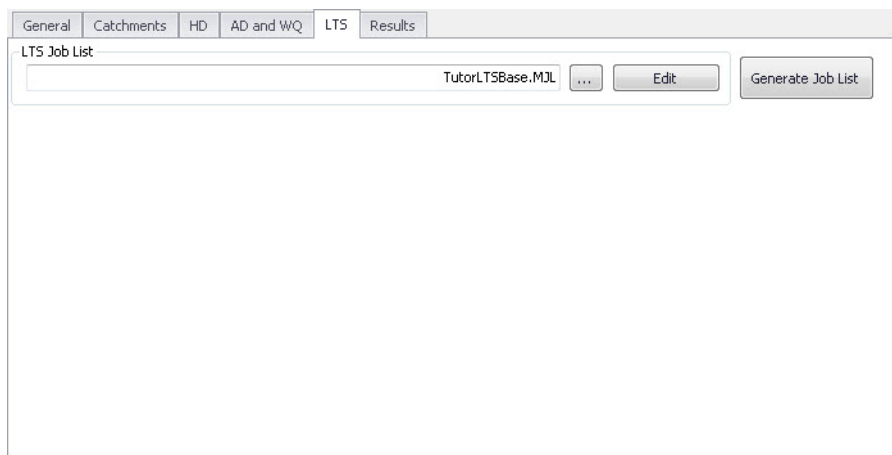

Figure 15.10 The Simulation Setup Editor LTS Tab

Table 15.6 Simulation Setup LTS tab attributes (Table msm\_Project)

Edit field	Description	Used or required by simulations	Field name in datastructure
LTS Job List	Defines the Job List *.MJL file name and path to be used in the LTS simulation	Yes If Simulation Type = Long Term Simulation (LTS)	MJLFileName

The LTS tab also has buttons for the following functions:

### ‘Edit’ button

Opens the specified Job List file (\*.MJL) in text editor. If the Job List File dialog is empty, or the specified file does not exist or is empty, the ‘Edit’ button opens an empty ASCII file.

### ‘Generate Job List’ button

Starts a Job List generation process. This is a special form of simulation where the output is a Job List file (\*.MJL).

More details on Job List generation and editing are found in the Long Term Statistics (LTS) User Manual.

## 15.1.6 Results

The Results tab includes parameters for defining output from a simulation setup.

Multiple result files may be specified for each simulation setup.

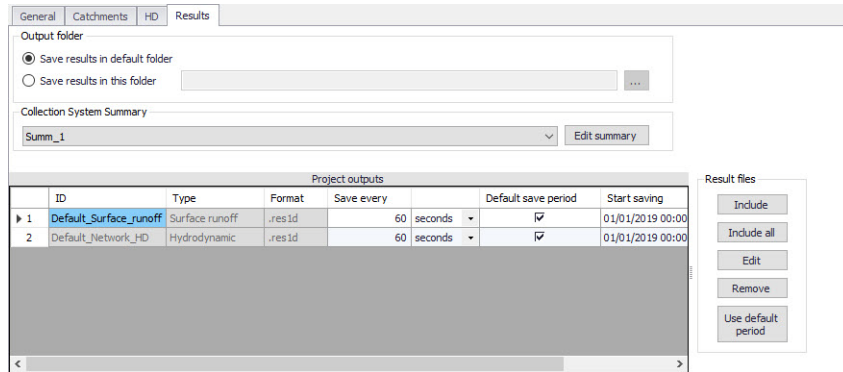

Figure 15.11 Results Tab of the Simulation Setup Editor showing multiple result items

Table 15.7 Overview of Simulation Setup Results tab attributes (Table msm\_Project)

Edit field	Description	Used or required by simulations	Field name in datastructure
Save Results in Default Folder/Save Results in this Folder [Output Folder radio buttons]	Toggles between Default folder and user-specified folder for output file location	Yes	HDOuputNo
[Input box beside 'Save Results in this Folder' option]	Contains the path for user-specified output destination folder	Yes if 'Save Results in this Folder' activated	HDFolderPath





Table 15.7 Overview of Simulation Setup Results tab attributes (Table msm\_Project)

Edit field	Description	Used or required by simulations	Field name in datastructure
Collection System Summary dropdown menu	Specifies a MIKE1D simulation summary. User selects from the list of available summaries. Only one network summary per simulation job is possible.	Yes if including a network simulation	SummaryID
Edit Summary button	Opens the Network Summary editor with the current summary in focus. Allows for editing summary contents. If user has specified a non-existing summary ID, program automatically creates a new summary record with default contents and opens the summary editor with the new summary in focus.	Yes	-

A secondary grid in the Simulation Setup Results tab displays a list of the output files selected for the simulation setup (Figure 15.12). The grid retrieves the information from the Result Files editor (Result Specifications| Result Files).

Project outputs							Result files	
ID	Type	Format	Save every	Default save period	Start saving	End saving		
1	HD	Hydrodynamic	.res1d	60 seconds	<input checked="" type="checkbox"/>	03-01-1936 ...	28-12-1979 ...	<input type="button" value="Include"/> <input type="button" value="Include all"/> <input type="button" value="Edit"/> <input type="button" value="Remove"/> <input type="button" value="Use default period"/>
2	Default_Network_...	Real time control	.res1d	60 seconds	<input checked="" type="checkbox"/>	03-01-1936 ...	28-12-1979 ...	
3	Default_Network_...	Hydrodynamic	.res1d	60 seconds	<input checked="" type="checkbox"/>	03-01-1936 ...	28-12-1979 ...	
4	Default_Network_...	Pollution trans...	.res1d	60 seconds	<input checked="" type="checkbox"/>	03-01-1936 ...	28-12-1979 ...	
5	Default_LTS_extr...	LTS extreme s...	.res1d	60 seconds	<input checked="" type="checkbox"/>	03-01-1936 ...	28-12-1979 ...	
6	Default_LTS_chro...	LTS chronologi...	.res1d	60 seconds	<input checked="" type="checkbox"/>	03-01-1936 ...	28-12-1979 ...	
7	AD	Pollution trans...	.res1d	60 seconds	<input checked="" type="checkbox"/>	03-01-1936 ...	28-12-1979 ...	

Figure 15.12 The Project Outputs secondary grid in the Results Tab

The list of outputs is controlled by the user using functional buttons to the right of the grid.



The user selects output definitions to include from among those available in the project associated with the modules included in the simulation (and specified in the Result Files editor). The options are filtered according to the contents of the actual simulation.

The list will include at least one "Default" result file definition for each module (Runoff, Network HD, etc.) containing the most usual results for the entire model domain (e.g. runoff for all catchments, discharges and water levels for all model elements, etc.). The list of result file definitions may be extended by "user-specified" output definitions.

An overview of the attributes of the Project Outputs secondary grid is shown in Table 15.8 below.

Table 15.8 Overview of the Project Outputs secondary grid attributes (Table msm\_ProjectOutput)

Edit field	Description	Used or required by simulations	Field name in datastructure
ID	MUID of the selected output file definition	Yes	OutputID
Type	Shows type and default contents of the output file (read only)	Yes	ContentsTypeNo
Format	Shows the file format (read only)	Yes	FormatNo
Save Every	Specifies results saving frequency	Yes	DtSave
[Column to the right of 'Save Every' column]	Specified unit for result saving frequency	Yes	DtSaveUnitNo
Default Save Period checkbox	Specify to save results for the entire simulation (check), or for user-specified period only (uncheck)	Yes	DefaultSavePeriodNo
Start Saving	Defines start date and time for saving results	Yes if user-specified save period	SaveStartDate
End Saving	Defines end date and time for saving results	if user-specified save period	SaveEndDate



The following functional buttons are available for controlling the list of outputs in the Project Outputs secondary grid:

#### 'Include' button

Opens a list of all relevant output definitions for the simulation and allows the user to choose those which are to be added to the list.

#### 'Include all' button

Fills the list with all relevant pre-defined output definitions found in the database. Relevance is determined by the modules included in the simulation. If the list is not empty, it only adds those outputs which are not already in the list.

#### 'Edit' button

Opens the Result Files editor with the current output in focus.

#### 'Remove' button

Removes selected output(s) from the list.

#### 'Use Default Period' button

This function finds the full period available for an output item. The information is reflected in the Start Saving and End Saving secondary grid attributes. This tool may be used in defining user-specified saving periods to ensure they fall within valid periods.

## 15.2 Batch Simulation

If you need to run more simulations sequentially, you can choose to do so by including these to a batch simulation. This is done through the Batch Simulation editor.

The Batch Simulation editor includes functionalities allowing control and execution of batch simulations.

The 'Batch Run' button executes all simulations that have the 'Include to batch' flag set in the sequence that they are specified in the grid table. This means that multiple simulations and scenarios can be simulated in batch without user interaction.

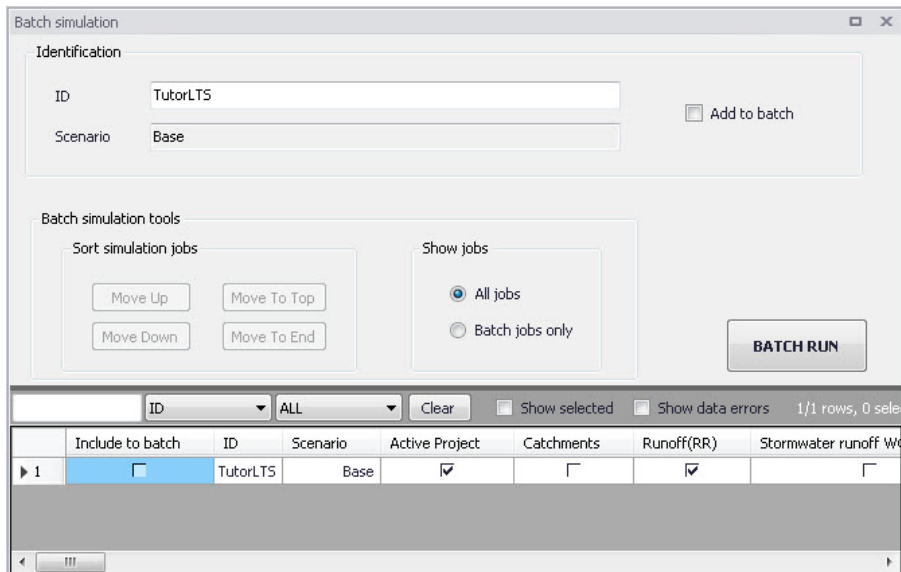

Figure 15.13 The Batch Simulation Editor

The Batch Simulation editor manages the same data from the Simulation Setup editor. The grid table shows the same entries as the grid in the Simulation Setup editor, but built-in tools allow reordering and filtering of simulation job records for batch execution.

Table 15.9 Overview of Batch Simulation editor fields (Table msm\_Project)

Edit field	Description	Used or required by simulations	Field name in datastructure
ID	ID of the simulation setup	Yes	MUID
Scenario	Scenario for the simulation setup	Yes	ScenarioName
Add to Batch checkbox	Option for including a simulation setup to batch	Yes	IncludeToBatchNo

The following functionalities are available on the editor:

#### Move Up

Moves the active record one position up in the grid.

#### Move Down

Moves the active record one position down in the grid.



### Move To Top

Moves the active record to the top of the table.

### Move To End

Moves the active record to the bottom of the table.

### 'All jobs' and 'Batch jobs only' radio buttons

This filters the list of simulation jobs displayed in the table. A complete list of simulation jobs (i.e. All jobs) is shown by Default, but the display can be reduced to show only those jobs included in the batch (i.e. Batch jobs only).

### 'Batch Run' button

This starts a batch job execution following the sequence of the simulation jobs on the list. Each consecutive job must wait until the previous job has been fully completed. All user prompts are suppressed during the batch job execution, i.e. the simulations are automatically executed without user prompts.





# INDEX



<b>K</b>	
Kinematic Wave . . . . .	175
<b>L</b>	
Linear Reservoir . . . . .	178
<b>R</b>	
RDI . . . . .	186
<b>U</b>	
Unit Hydrograph Method . . . . .	183