

MIKE 1D

DHI Simulation Engine for 1D river and
urban modelling

Reference Manual





PLEASE NOTE

COPYRIGHT

This document refers to proprietary computer software which is protected by copyright. All rights are reserved. Copying or other reproduction of this manual or the related programs is prohibited without prior written consent of DHI A/S (hereinafter referred to as "DHI"). For details please refer to your 'DHI Software Licence Agreement'.

LIMITED LIABILITY

The liability of DHI is limited as specified in your DHI Software Licence Agreement:

In no event shall DHI or its representatives (agents and suppliers) be liable for any damages whatsoever including, without limitation, special, indirect, incidental or consequential damages or damages for loss of business profits or savings, business interruption, loss of business information or other pecuniary loss arising in connection with the Agreement, e.g. out of Licensee's use of or the inability to use the Software, even if DHI has been advised of the possibility of such damages.

This limitation shall apply to claims of personal injury to the extent permitted by law. Some jurisdictions do not allow the exclusion or limitation of liability for consequential, special, indirect, incidental damages and, accordingly, some portions of these limitations may not apply.

Notwithstanding the above, DHI's total liability (whether in contract, tort, including negligence, or otherwise) under or in connection with the Agreement shall in aggregate during the term not exceed the lesser of EUR 10.000 or the fees paid by Licensee under the Agreement during the 12 months' period previous to the event giving rise to a claim.

Licensee acknowledge that the liability limitations and exclusions set out in the Agreement reflect the allocation of risk negotiated and agreed by the parties and that DHI would not enter into the Agreement without these limitations and exclusions on its liability. These limitations and exclusions will apply notwithstanding any failure of essential purpose of any limited remedy.





CONTENTS

| | | |
|----------|--|----|
| 1 | Introduction | 11 |
| 1.1 | How To Use this Manual | 11 |
| 1.2 | Symbols | 12 |
| 1.2.1 | Definitions | 12 |
| 2 | Overview of Network Geometry | 15 |
| 2.1 | Reaches | 15 |
| 2.2 | Nodes | 16 |
| 2.3 | Digi Points | 17 |
| 2.4 | Grid Points | 17 |
| 2.5 | Specification of a Reach | 18 |
| 2.6 | Specification of Nodes | 19 |
| 2.6.1 | Circular manholes | 19 |
| 2.6.2 | Basins | 20 |
| 2.6.3 | Outlets | 21 |
| 2.6.4 | Cover types | 21 |
| 2.6.5 | Maximum rainfall runoff inflow | 22 |
| 2.7 | Selecting an Appropriate Network Topology | 22 |
| 2.7.1 | Selecting the area to be modelled | 22 |
| 2.7.2 | Selecting which reaches to include | 22 |
| 2.7.3 | Selecting the grid spacing | 23 |
| 3 | Cross Sections | 25 |
| 3.1 | Pre-defined Cross Sections | 26 |
| 3.2 | User-specified Cross Sections | 27 |
| 3.2.1 | Markers on open cross sections | 28 |
| 3.3 | Resistance Specification | 29 |
| 3.3.1 | Relative resistance numbers | 30 |
| 3.3.2 | Calibration of resistance numbers | 30 |
| 3.3.3 | Manning formulation | 30 |
| 3.3.4 | Chezy formulation | 31 |
| 3.3.5 | Darcy-Weisbach formulation | 32 |
| 3.3.6 | Colebrook-White formulation for circular pipes | 32 |
| 3.3.7 | Hazen-Williams formulation | 33 |
| 3.3.8 | Depth-variable resistance number | 34 |
| 3.3.9 | Distributed resistance numbers | 35 |
| 3.3.10 | Flow bank zones | 35 |
| 3.3.11 | Multi zone resistance specification | 35 |
| 3.4 | Processing of Raw Data | 36 |



| | | |
|----------|--|-----------|
| 3.4.1 | Relative resistance and effective area | 36 |
| 3.4.2 | Hydraulic radius | 37 |
| 3.4.3 | Calculation of processed resistance numbers | 42 |
| 3.4.4 | Manual modification of the resistance factor | 43 |
| 3.4.5 | Processing of user specified cross sections from MIKE+ | 43 |
| 3.4.6 | Conveyance modifications | 44 |
| 3.5 | Top Slot | 45 |
| 3.6 | Bottom Slot | 46 |
| 3.7 | Flooded Areas and Relative Resistance | 47 |
| 4 | Hydrodynamic Module | 49 |
| 4.1 | Saint-Venant Equations | 49 |
| 4.2 | Pressurised Flow | 50 |
| 4.2.1 | Smooth transition to top slot | 51 |
| 4.2.2 | Pressure reaches | 51 |
| 4.3 | Resistance | 52 |
| 4.4 | Numerical Schemes | 52 |
| 4.4.1 | Multiple threads can influence results | 54 |
| 4.5 | Super Critical Flow | 54 |
| 4.5.1 | Convection suppression factor | 55 |
| 4.5.2 | Effect of convection suppression on energy heads | 56 |
| 4.6 | Headloss in Nodes | 57 |
| 4.6.1 | Headloss is applied as water flows out of nodes | 57 |
| 4.6.2 | Headloss calculation for inflowing water | 58 |
| 4.6.3 | Headloss calculation for outflowing water | 60 |
| 4.6.4 | Limiting the total headloss for outflowing water | 63 |
| 4.6.5 | Selecting an appropriate local headloss computation | 63 |
| 4.7 | Low Flow Conditions | 69 |
| 4.8 | Flood Plains | 70 |
| 4.9 | HD Parameters | 74 |
| 4.10 | Initial Conditions | 74 |
| 4.10.1 | Minimum water depth | 75 |
| 4.10.2 | Initial conditions provided state start | 75 |
| 4.10.3 | Local initial conditions / parameter values | 75 |
| 4.10.4 | Initial conditions provided by hotstart | 76 |
| 4.10.5 | Flush out | 76 |
| 4.10.6 | Flush-in from boundaries | 76 |
| 4.10.7 | Minimum node levels from surrounding reaches | 77 |
| 4.10.8 | Natural flow | 78 |
| 4.11 | Wind Forcing | 78 |
| 4.12 | Stability Conditions and Discretisation | 79 |
| 4.13 | Adaptive Time Step Size | 80 |
| 4.13.1 | Adaptive step size methodology | 81 |
| 4.13.2 | Boundary value check | 81 |
| 4.13.3 | Solution check: Discharge variation in grid points | 82 |
| 4.13.4 | Solution check: Water level variation in grid points | 83 |
| 4.13.5 | Solution check: Water level variation in nodes | 83 |



| | | |
|----------|--|-----------|
| 4.13.6 | Solution check: Courant value | 84 |
| 4.13.7 | Solution check: Pumps | 85 |
| 4.13.8 | Solution check: Cross section parameters | 85 |
| 5 | Boundaries | 87 |
| 5.1 | Open Boundary Conditions | 88 |
| 5.1.1 | Closed boundary | 88 |
| 5.1.2 | Inflow boundary and lateral inflow | 88 |
| 5.1.3 | Water level boundary - the outlet | 88 |
| 5.1.4 | QH boundary | 89 |
| 5.1.5 | Which boundary condition? | 90 |
| 5.2 | Additional Boundary Sources | 90 |
| 5.2.1 | Point source boundaries | 90 |
| 5.2.2 | Distributed source boundaries | 91 |
| 5.2.3 | Global source boundaries | 92 |
| 5.3 | Boundary Items | 93 |
| 5.3.1 | Application time | 93 |
| 5.3.2 | Soft start | 94 |
| 5.3.3 | Resolution of a time varying boundary item | 94 |
| 6 | Structures | 95 |
| 6.1 | General Flow Conditions | 95 |
| 6.1.1 | Zero flow | 95 |
| 6.1.2 | Drowned flow | 95 |
| 6.1.3 | Free overflow | 95 |
| 6.1.4 | Contraction and expansion losses | 96 |
| 6.1.5 | Composite structures | 97 |
| 6.1.6 | External structures with reservoir | 97 |
| 6.2 | Overflow Formula (MIKE+ Broad Crested Weir) | 97 |
| 6.2.1 | Free overflow formulation | 98 |
| 6.2.2 | Submerged overflow | 100 |
| 6.3 | QH Structure (Special Weir) | 101 |
| 6.3.1 | Special weirs | 101 |
| 6.3.2 | Tabulated structure | 102 |
| 6.4 | Pump | 102 |
| 6.4.1 | Real time control | 102 |
| 6.4.2 | Start and stop levels | 103 |
| 6.4.3 | Maximum pump discharge | 103 |
| 6.4.4 | Start-up and shut-down times | 103 |
| 6.4.5 | Outlet level | 104 |
| 6.4.6 | Negative discharge | 104 |
| 6.4.7 | Time centring | 104 |
| 6.5 | Valve | 104 |
| 6.6 | Orifice with Gate | 105 |
| 6.6.1 | Orifice and gate polygons | 106 |
| 6.6.2 | Definition of verticals and slices | 106 |
| 6.6.3 | Geometrical factors that determine the discharge through a slice | 107 |
| 6.6.4 | Calculating the discharge through a slice | 108 |



| | | |
|----------|--|------------|
| 6.7 | Culvert | 110 |
| 6.7.1 | User specified QH relations | 110 |
| 6.7.2 | Calculated QH relations | 112 |
| 6.8 | Weir Formula Structure | 118 |
| 6.8.1 | Weir Formula 1 | 118 |
| 6.8.2 | Weir Formula 2 (Honma) | 118 |
| 6.8.3 | Weir Formula 3 (extended Honma) | 119 |
| 6.9 | Control Structures | 119 |
| 6.9.1 | Hydraulic aspects - radial gates | 120 |
| 6.9.2 | Hydraulic aspects - sluice gates | 121 |
| 6.9.3 | Hydraulic aspects - overflow structures | 124 |
| 6.9.4 | Hydraulic aspects - underflow structures | 124 |
| 6.9.5 | Free flow | 125 |
| 6.9.6 | Drowned flow | 126 |
| 6.10 | Dambreak | 127 |
| 6.10.1 | Failure moment | 127 |
| 6.10.2 | Energy equation based dam breach modelling | 127 |
| 6.10.3 | Erosion based breach development using the energy equation | 129 |
| 6.10.4 | NWS DAMBRK dam breach methods | 134 |
| 6.11 | Bridges | 137 |
| 6.11.1 | Arch Bridges (Biery and Delleur) | 138 |
| 6.11.2 | Arch Bridges (Hydraulics Research (HR) method) | 140 |
| 6.11.3 | Bridge Piers (Nagler) | 141 |
| 6.11.4 | Bridge Piers (Yarnell) | 142 |
| 6.11.5 | Energy Equation | 144 |
| 6.11.6 | Federal Highway Administration (FHWA) WSPRO method | 147 |
| 6.11.7 | US Bureau of Public Roads (USBPR) method | 157 |
| 6.11.8 | Multiple Waterway Opening | 159 |
| 6.11.9 | Pressure Flow, Federal Highway Administration method | 159 |
| 6.11.10 | Road overflow, Federal Highway Administration method | 162 |
| 6.11.11 | Trouble shooting for bridge structures | 163 |
| 7 | Rainfall Runoff | 165 |
| 7.1 | General Information | 165 |
| 7.1.1 | Runoff models available in the 1D engine | 165 |
| 7.1.2 | Organisation of runoff model data | 166 |
| 7.2 | NAM Rainfall Runoff Model | 166 |
| 7.2.1 | Introduction | 166 |
| 7.2.2 | Model structure | 167 |
| 7.2.3 | Data requirement | 169 |
| 7.2.4 | Basic modelling components | 172 |
| 7.2.5 | Extended groundwater components | 175 |
| 7.2.6 | Snow module | 177 |
| 7.2.7 | Irrigation module | 183 |
| 7.2.8 | Model parameters | 187 |
| 7.2.9 | Surface and root zone parameters | 187 |
| 7.2.10 | Groundwater parameters | 190 |
| 7.2.11 | Snow module parameters | 193 |



| | | |
|----------|--|------------|
| 7.2.12 | Irrigation module parameters | 193 |
| 7.2.13 | Initial conditions | 195 |
| 7.2.14 | Model calibration | 196 |
| 7.3 | Time-Area Surface Runoff Model | 203 |
| 7.3.1 | Concept | 203 |
| 7.3.2 | Input data | 203 |
| 7.3.3 | Runoff computation | 205 |
| 7.3.4 | Multiple-event simulations | 208 |
| 7.4 | Kinematic Wave Surface Runoff Model | 209 |
| 7.4.1 | Concept | 209 |
| 7.4.2 | Input data | 210 |
| 7.4.3 | Runoff computations | 212 |
| 7.4.4 | Multiple-Event Simulations | 220 |
| 7.5 | Linear Reservoir Surface Runoff Model | 222 |
| 7.5.1 | Concept | 222 |
| 7.5.2 | Input data | 222 |
| 7.5.3 | Runoff computation | 224 |
| 7.5.4 | Multiple-event simulations | 231 |
| 7.6 | Unit Hydrograph Surface Runoff Model (UHM) | 232 |
| 7.6.1 | Concept | 232 |
| 7.6.2 | The loss model | 233 |
| 7.6.3 | Unit hydrograph routing model | 239 |
| 7.7 | Combined Rainfall Runoff models | 246 |
| 7.8 | Parameters in the INI files | 246 |
| 7.9 | Input Data | 247 |
| 7.9.1 | Precipitation | 247 |
| 7.9.2 | Evaporation | 248 |
| 7.9.3 | Temperature | 248 |
| 7.9.4 | Catchment discharge and load | 248 |
| 7.9.5 | Time series data types | 248 |
| 7.10 | Application of 2D Grid Data | 249 |
| 7.11 | Additional Flow and Catchment Discharge | 250 |
| 7.11.1 | Additional flow | 250 |
| 7.11.2 | Catchment discharge | 251 |
| 7.11.3 | Total load | 251 |
| 7.12 | Nomenclature | 252 |
| 8 | Stormwater Quality (SWQ) | 255 |
| 8.1 | Introduction | 255 |
| 8.2 | Build-up/Wash-off method | 256 |
| 8.2.1 | Build-up of pollution on the catchment | 256 |
| 8.2.2 | Wash-off of pollution by rainfall | 257 |
| 8.3 | Event Mean Concentration (EMC) method | 258 |
| 8.3.1 | Definition of rain events | 259 |
| 8.3.2 | Pollutant wash-off routing | 260 |
| 9 | Data Assimilation in MIKE 1D | 261 |
| 9.1 | Data assimilation framework | 262 |



| | | |
|---|---|------------|
| 9.2 | Ensemble Kalman filter | 264 |
| 9.2.1 | Model errors described by auto-regressive processes | 266 |
| 9.3 | Constant weighting function | 266 |
| 9.3.1 | Error forecast modelling | 268 |
| 10 | Long Term Statistics (LTS) | 271 |
| 10.1 | Introduction | 271 |
| 10.2 | LTS instantaneous events | 271 |
| 10.2.1 | Examples | 271 |
| 10.3 | LTS accumulated events | 272 |
| 11 | References | 273 |
| Appendix A Hydrodynamic Module | | 277 |
| A.1 | DERIVING THE SAINT-VENANT EQUATIONS | 279 |
| A.2 | SOLVING THE SAINT-VENANT EQUATIONS | 285 |
| A.3 | MASS BALANCE | 305 |
| A.4 | SOME SPECIAL TECHNIQUES | 307 |
| Appendix B Structure Module | | 313 |
| B.1 | QH RELATIONS CALCULATED FOR CULVERTS | 315 |
| Appendix C Misc | | 323 |
| C.1 | 2D MAPPING, FLOOD MAPS | 325 |
| Appendix D Default Values in MIKE 11 and MIKE+ | | 331 |
| D.1 | MIKE 11 DEFAULT VALUES | 333 |
| D.2 | MIKE11.INI FILE SETTINGS | 335 |
| D.3 | DHIAPP.INI FILE SETTINGS | 337 |
| Index | | 341 |



1 Introduction

This document describes the 1D computational engine for modelling unsteady flows in pipe networks, river networks and estuaries.

The modelling of unsteady flow is based on an implicit, finite difference numerical solution of the one-dimensional shallow water equations (Saint Venant equations). The numerical algorithms provide efficient and accurate solutions in branched and looped pipe and river networks.

The computational scheme is applicable to vertically homogeneous flow conditions. These conditions are found in pipes ranging from small profile collectors for detailed urban drainage and pressurised sewer mains affected by the varying water level at the outlet, to open rivers, channels and flood plains extending from steep rivers to tidal-influenced estuaries.

Both subcritical and supercritical flows are treated by means of the same numerical scheme that adapts to local flow conditions. Flow features such as backwater effects and surcharges are simulated precisely.

Pressurised flow computations are modelled using a narrow vertical extension of closed pipes. Free surface and pressurised flows are thus described with the same numerical scheme, which ensures a smooth and stable transition between the two flow types.

Advanced models describing flow over hydraulic structures including structure control are also included.

The features implemented in the conceptualisation of physical systems enable realistic and reliable simulations of the performance of both existing sewage and river network and those under design.

1.1 How To Use this Manual

This manual describes the 1D computational engine.

Setting up a model for the 1D engine can be done in MIKE+ or in the MIKE HYDRO River / MIKE 11 setup editor. This is not a manual for either MIKE+ or MIKE HYDRO River / MIKE 11. However, at times it is appropriate to refer to one of these, or to describe how certain things are handled in MIKE+ or MIKE HYDRO River / MIKE 11.

NOTE: As a rule of thumb, comments made for MIKE 11 in this manual also apply to MIKE HYDRO River.



Throughout the manual we will use the following styles for product specific text:



Text that has this graphic tag at its side is only relevant for people using MIKE+ (Collection System) when setting up a model. If urban components are not relevant for you, this text can be omitted.

The text relevant for urban components can span several paragraphs, and stops at the first occurrence of a quadratic black box: ■



Text that has this graphic tag at its side is only relevant for people using river components. If river components are not relevant for you, this text can be omitted.

The text relevant for river components can span several paragraphs, and stops at the first occurrence of a quadratic black box: ■

1.2 Symbols

| | |
|--------------|--|
| A | : Without any subscript, it will refer to a flow area A_{fl} |
| A_{fl} | : Flow area, also called cross section area |
| A_s | : Surface area |
| b_s | : Storage width, the width of the surface in a cross section |
| D | : Water depth at node |
| d | : Water depth at grid point |
| F or F_r | : Froude number |
| f | : Friction factor (in HD context), right hand side (in solver context) |
| g | : Gravity |
| H | : Water level at a node |
| h | : Water level at a grid point |
| H_b | : Bottom level, lowest point of node. Also called <i>invert level</i> |
| h_b | : Bottom level, lowest point of cross section |
| I or I_b | : Bottom slope |
| I_f | : Friction slope |
| I_h | : Water level slope |
| K | : Conveyance |
| q or Q | : Flux through a grid point |
| R | : Hydraulic radius |
| v | : Flow velocity at grid point, $v = \frac{Q}{A}$ |

1.2.1 Definitions

Common terms and definitions that will be used throughout the document:



The *friction slope* I_f is equal to the slope of the energy grade line and is defined as:

$$I_f = \frac{\tau}{\rho g R} \quad (1.1)$$

where:

- τ = tangential stress caused by the wall friction, [Nm^{-2}],
- ρ = density of water, [kgm^{-3}],
- R = hydraulic radius, [m], ($= A/P$, where P is the wetted parameter).





2 Overview of Network Geometry

The 1D engine simulates water flow on a network. A network consists of

- Reaches
- Nodes
- Grid points
- Digi points
- Cross sections
- Structures

Figure 2.1 shows an example of a small network with four nodes and three reaches, each having a number of grid points and digi points. Note that the figure does not show the shape of cross sections or structures.

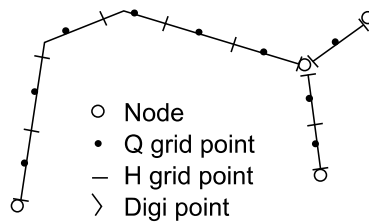

Figure 2.1 Example of network

A cross section is the 2D intersection of a channel (typically a river or a sewage pipe), perpendicular to the channel direction. Among other things, cross sections determine the volume of water in a channel for a given water depth. For a detailed description of the cross sections, see Chapter 3.

A structure is a parameterised model that can calculate a flow over (or through) the structure based on an upstream and downstream water level. Examples are weirs, gates, orifices and pumps. For a detailed description of structures, see Chapter 6.

2.1 Reaches

A reach is a one-dimensional connection between two nodes in a network.

The reach has many synonyms in different areas of application. In sewer models it is often called a *link* or *pipe*, in river models a *branch*, stream, *canal* or channel, and in graph and network theory it is called a link or an edge. In this manual only the term “reach” is used.

A position along a reach is given as the distance from a reference “start” point on the reach. This distance is called a *chainage*.



The start of the reach is defined as the point in the reach with the lowest chainage, and the end of the reach is defined as the point with the highest chainage; the terms start and end of reach is thus defined based on low and high chainage values, which does not necessarily correlate with the direction of water flow in the reach. The chainage at the start of the reach need not to be zero.

A reach also has an *upstream* end and a *downstream* end. These are defined based on the *direction of natural flow* (part of the reach specification): If the flow is naturally in the direction of increasing chainages, the upstream matches the start of the reach and the downstream matches the end of the reach. If the flow is naturally in the direction of decreasing chainages, the upstream matches the end of the reach and the downstream matches the start of the reach.

A *location* is a position along a reach, and is defined by the reach name and a chainage value.

Reaches come in many different geometrical variations:

- A sewer reach is featured by a constant cross section and constant friction properties along its entire length. It can also assume a straight line layout between its nodes, giving a constant bottom slope.
- A river reach is featured by varying cross sections along its length, varying friction with the cross section shape and the current water level. The river reach tends to meander through the landscape.

Many variations exist between these two extremes.

2.2 Nodes

Points associated with reach ends and reach junctions are called nodes. Each reach has one node in each end. A node is associated with at least one reach, but an arbitrary number of reaches can be attached to a single node, defining the junction of all the reaches. A node is always present in a junction in the network.

Nodes can be volume free; then they function as simple junctions that connects two or more reaches, called a *junction node*. A junction node does not have any qualitative impact on the flow it passes the node

Nodes can also have a volume, as for example a manhole in a sewer, in which case the volume is considered during the calculation. When water flows through such a node, the node will usually impose additional flow resistance; the water will lose some energy while passing the node. Flow resistance and energy loss in a node is called *headloss*



Volume-free nodes with only one reach are called *boundary nodes*. In boundary nodes, a boundary condition must be specified. A boundary condition can, for example, specify a water level.

Nodes can be one of several different types:

- Junction nodes, the volume free node
- Manholes
- Basins
- Outlets

A node has a geographical (x,y) position. It can also have an identification string, which is used when inflow is to be added to the node, or attaching a structure to the node.

A node is a computational point, and contains a water level.

2.3 Digi Points

Digi points are the georeferencing of a reach, and are defined in cases when the reach is not a straight line between two nodes. A reach can have from two to any number of digi points, though the first and last digi point should (approximately) match the coordinate of the nodes (if not, coordinates of the nodes are added as the first/last digi points).

Each digi point has a (x,y) geographical coordinate and a reach chainage. The chainage defines the location of this digi point along the reach. In effect a digi point couples a reach location to a geographical (x,y) coordinate.

A digi point can also specify a z coordinate, in which case it defines the bottom level of the reach. If the cross section data also specifies a bottom level, the cross section bottom level overrules the digi point bottom level.

2.4 Grid Points

Grid points are the computational points in a reach. At each grid point a dependent variable is defined. For a flow model this is either water level or discharge.

A reach has a number of grid points along its length, at certain locations. Grid points do usually not coincide with the digi points. To get the geographical coordinate of a grid point, the grid point's chainage value is used to interpolate along the digi point coordinates.

A flow model has different types of grid points:



- H grid point. The water level is defined in the H grid point. It also has an associated cross section.
- Q grid point. The discharge or flow velocity is defined in a Q grid point.
- Structure grid point. A structure grid point has an associated structure, that calculates the discharge over the structure depending on the water levels on each side of the structure.

2.5 Specification of a Reach

A reach requires specification of where the reach connects and specification of its digi points.

A reach can connect upstream and downstream in two ways:

- By specifying an upstream/downstream node.
- By specifying a reach location in another reach.

In the latter case, if there is not already a node at that reach location, a junction node will be added at the specified reach location, and the other reach will be split into two smaller reaches, which are connected to the newly created node.

Digi points define the georeferencing of the reach. They are also used to define the vertical profile of the reach, in case the cross section data for the reach does not include any vertical specification. If no vertical profile is specified, it is assumed that the reach has a constant slope from the upstream node bottom level to the downstream node bottom level.

The length of the reach is defined by the difference in the chainage value of the first and the last digi points.

The direction of natural flow can also be specified. The default is *positive flow*, and defines that positive flow is in the direction of increasing chainages. By setting the flow direction to negative, the positive flow is in the direction of decreasing chainages. The flow direction has impact on the definition of upstream and downstream direction and the specification of all flow parameter on the reach, as e.g. discharge initial conditions, open inflow boundary conditions (inflow and QH boundary), structure and control parameters, etc.



In a MIKE+ (Collection System) setup, two digi points, one at each end, are automatically added as the first/last digi point in the list, with the (x,y) coordinate of the upstream and downstream node and the invert level respectively. If more digi points are defined in MIKE+ without a z-coordinate, then it is assumed that the reach has a constant bottom slope from the upstream node to the downstream node.



The cross section definition, friction parameters and other reach parameters are specified on the reach. Each reach has a cross section reference and a material reference, and specifies amongst other things the length of the link and the upstream and downstream invert level (the level where the reach connects to the nodes.) ■



In a MIKE+ (Collection System) setup, a reach can be specified as a **non-return reach**. A non-return reach will gradually decrease the discharge across the first q -grid point in the reach is downstream water level becomes larger than upstream water level.

If the upstream water level becomes larger than downstream water level, the reach will gradually re-open to allow free flow across the first q -grid point. The gradual closing and re-opening of the flow is implemented to suppress artificial wave formation in the network.

The time period used for re-opening the flow can be controlled in the *dhiapp.ini* file with the NON_RETURN_VALVE_STARTUP_PERIOD parameter. ■

2.6 Specification of Nodes

In the specification of the network, all nodes need not be specified. If a reach is missing a node, nodes will automatically be added by the engine during initialisation.

- At network boundaries that do not have a node specified, MIKE 1D will create a boundary node.
- If two or more reaches connect at a location, and no node exist at that location, MIKE 1D will create a junction node at that location.

A junction node needs no further specification than its location. For nodes with a volume, further information on the geometry of the node must be specified, as described below.

2.6.1 Circular manholes

A circular manhole is a vertical cylinder, defined by the following parameters:

| | |
|-------|---|
| H_b | : Bottom level, called <i>invert level</i> on Figure 2.2. |
| H_g | : Ground level. |
| Dia | : Diameter |
| H_c | : Critical level. |

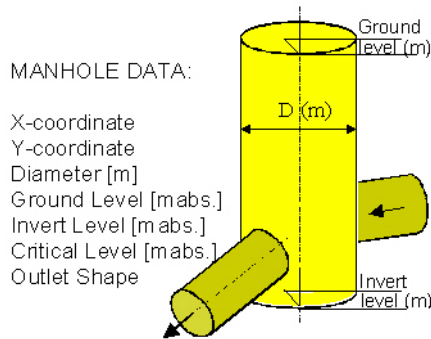

Figure 2.2 Manhole

A manhole can add headloss to the flow calculations, see Section 4.6.

Behaviour for levels above the ground level is defined by the, see Section 2.6.4.

Each manhole can have its own critical level. If the water level in a manhole increases above the critical level, then a warning is issued. This is the only use of the critical level; the value of the critical level has no influence on the result of the simulation.



This node type is not supported by MIKE 11. ■

2.6.2 Basins

This type of node is associated with arbitrarily shaped structures of significant volume: Non-circular manholes, tanks, reservoirs, basins and natural ponds.

The geometry is parametrised and defined by a table of water levels H , and associated cross sectional flow areas A_{fl} and surface areas A_s .

The first set of values in the table corresponds to the bottom of the basin, and the last set of values corresponds to the ground level. Intermediate values are linearly interpolated. The H -column can start at any value, for example 0.0 for the interpretation of H as the depth in the basin. The engine will associate the first H -value to the bottom level of the node.

The basin volume contributes to the overall system volume and is included in the computations.

A basin can add headloss to the flow calculations, see Section 4.6 for details.

Behaviour for levels above the ground level is defined by the cover type, see Section 2.6.4 for details.



This node type is not supported by MIKE 11. ■

2.6.3 Outlets

Outlets are nodes where the system interacts with external waters. The external water volume is assumed to be so large that the outlet water level is not affected by the outflow from/inflow to the system. As such, outlets are appropriate for the simulation of flow recipients and sources (lakes and oceans).

Depending on flow conditions at the outlet, both inflow and outflow can occur.

Outlets are defined with the following parameters

H_b : *Bottom level.*
 H_g : *Ground level.* Only used for presentation purposes.

If the reach connected to the outlet defines a bottom level, the bottom level in the outlet must match the bottom level of the reach.

The water level at an outlet is specified as a boundary condition and can take any form of a boundary source (constant, periodic, time series), see Section 5.1.3 for details.



MIKE 11 does not allow the editing of ground levels of its outlets. The ground level is set to be the bottom level of the reach connected to the outlet. ■

2.6.4 Cover types

If the water level exceeds the ground level of a node H_g , then 1D engine applies one of three different covers that provides methods for handling the water:

1. *Expanding cover* creates a wide circular inundation basin that starts 0.25m below ground level and expands exponentially to 1000 times the surface area of the node. See Section A.4.1 in the Appendix for details.
2. *Sealed cover* creates a narrow slot that starts 0.25m below ground level. The slot contracts gradually and in effect prevents water flowing out of the node. See Section A.4.2 in the Appendix for details.
3. *Spilling cover* creates a free overflow at a given distance above ground level (this distance is called the *buffer pressure*). The width of the crest expands exponentially, which ensures that the water level never rises very high above the crest level. See Section A.4.3 in the Appendix for details.

2.6.5 Maximum rainfall runoff inflow



In MIKE+ (Collection System), a maximum inflow can be specified for a node. The idea is that the physical size of a manhole limits how much water can flow into the node. Because of this definition, MIKE+ (Collection System) (and MIKE 1D) applies the maximum inflow to surface water only, and therefore be extension only water from rainfall runoff.

If a maximum inflow is specified for a node, then any excessive water will collect in a pool at the node and be released in sub-sequent time steps when the inflow falls below the maximum inflow. This means that if the maximum inflow from rainfall runoff is exceeded, then the inflow to the node will be limited to the maximum inflow, and remain at the maximum inflow until all the water from the boundary has run into the node.

2.7 Selecting an Appropriate Network Topology

Selection of the network topology is without doubt the most important task in the modelling process. A carefully selected network topology will avoid many problems during the calibration and application phase. It is, however, not possible to give detailed guidelines on how to design the network for all cases. The design should be based on a thorough insight into the hydraulics of the area to be modelled and an understanding of how the model works. Experience is, therefore, a key factor in the selection of the network topology. Some general guidelines for the less experienced user are given below.

2.7.1 Selecting the area to be modelled

When selecting the extent of the area to be modelled the following should be taken into consideration:

- Topographical/bathymetric data should be available for the entire area.
- At the model boundaries, time series of water level or discharge or a rating curve should be available, see Chapter 5.
- The boundary should be located at a sufficient distance from the area of interest to ensure that changes in the area of interest being investigated do not affect the boundary. This is of particular importance when the effects of major modifications to the flow are being investigated, for example, embankment and channelisation schemes.

2.7.2 Selecting which reaches to include

Reaches in 1D network represent flow paths, therefore in many cases it is quite clear where reaches should be included in the model.



It is important to note that the selection of reaches should be based on a compromise between computational time and the level of detail. The 1D engine is designed in such a way that it is relatively easy to include new reaches in existing setups. Thus, in general, it is advisable to limit the number of reaches in the initial setup and only include more reaches if required.

The following should be considered:

- River tributaries can be included in a model setup either as reaches or as *lateral inflows*. A lateral inflow will cause almost no increase in computational time and will be sufficiently accurate for most minor tributaries. A tributary included as a reach will give the correct routing (delay and attenuation) of the water flow, but will increase data requirements and computational time.
- Reaches are used in the schematisation of quasi 2D flow between flood cells, see Section 4.8.

2.7.3 Selecting the grid spacing

Given a hydraulic event to be modelled, the user has to determine the grid spacing; the distance between grid points in the model. The inexperienced user should base this selection of grid spacing on trial and error. Ideally, the model should be run first with a fairly large grid spacing, followed by runs with smaller and smaller grid spacings. The grid spacing to choose in the simulation is the largest grid spacing for which a smaller grid spacing does not significantly change the result of the simulation. Then the simulation result will be independent of the grid spacing parameter.

The stability conditions of the model depend mainly on the ratio between the time step and the grid spacing, see Section 4.4; i.e. when the space step is reduced it is also necessary to decrease the time step. The implication is that the computational time increases by a factor of 4 every time the space step is reduced by a factor of 2. Thus the number of grid points should be kept as low as possible.

From a simplified analysis of the numerical scheme it is possible to find some theoretical guidelines for the selection of the grid spacing. For instance, a certain number of grid points (about 30 to 50) per wave length is required to obtain a reasonable accuracy for the overall solution. In general the wave length(s) of a flow event can be expressed by

$$L = T\sqrt{gy} \quad (2.1)$$

where,

L wave length

T duration of event (wave period)



y water depth



In smaller rivers which experience flash floods a representative “wave period” may be a few hours. Thus a relatively small grid spacing will be required in order to resolve the flow events. In tidal flow with a period of more than 12 hours the wave length will mostly be very large, implying that a very large (20-30 km) grid spacing may be applied. In practice, however, variability of the cross sectional shape of the river, junctions with tributaries, etc. will require smaller grid spacing. ■

A relevant length scale for backwater effects is $L = y/l_b$, where l_b is the bottom slope. In models, where it is important to resolve backwater effects accurately, the grid spacing should be selected in such a way that the grid spacing is at least 4-6 times smaller than this length scale.



3 Cross Sections

A *cross section* is the 2D profile of a reach, perpendicular to the flow direction. The cross section defines for a given water level how much water the reach contains and controls how much and how fast water flows through the reach. Having sound and reliable cross section data is essential for high fidelity simulations.

- **Geometry**; defines the width and volume of water of the reach for a given water level.
- **Resistance**; defines how easily water flows through the reach.

There are two ways of representing the properties of a cross section:

- Raw data
- Processed data

Raw data describes the geometric shape of a cross section. The geometric shape is specified by a number of (x,z) coordinates, where x is the transverse distance from some point, often the left bank, and z is the corresponding bed elevation. The x coordinate is positive from left to right. The left/right sides of the cross section are defined relative to the downstream direction (direction of natural flow), i.e. when walking downstream. Usually, raw data is measured on location.

Processed data is an abstraction of a cross section. It describes properties of a reach for a number of water levels in tabular form. For each water levels, it includes:

- Storage/surface width, b_s
- Cross sectional area, as a geometric area A_g and an effective flow area A_{fl}
- Resistance number
- Hydraulic radius, R

For water levels, which are not present in the processed data table, values are estimated by interpolation.

The resistance number depends on the resistance formulation, being Chezy, Manning, etc, and is used differently for each formulation. Section 3.3 contains details on the resistance specifications and formulations.

A cross section can be specified using either raw or processed data. However, the engine works with processed data. For a cross section specified in raw data, the processed data is automatically calculated from the raw data.



The number of cross sections required for a model to perform well is determined from both physical and mathematical requirements. Physically there should be a sufficient number of cross sections to adequately define the variation in channel shape along each reach.

The cross sections are conceptually split into two different types:

- Pre-defined cross sections.
- User specified cross sections, either open or closed.

An open cross section typically defines a river bed. Closed cross sections typically define pipes in sewers.

The different types of cross sections are discussed below.

3.1 Pre-defined Cross Sections

Four different pre-defined closed cross section types are supported. These are mainly used within sewer models, and are therefore called pipe cross sections:

1. *Circular pipe*
2. *Rectangular pipe*
3. *O shaped pipe* ($H/B = 1.125$)
4. *Egg shaped pipe* ($H/B = 1.5$)

The parameters B and H are cross section width and height. See Figure 3.1 for the O-shaped and Egg-shaped cross sections.

The pre-defined cross sections are fully defined by specifying the cross section type and the characteristic dimension(s). While for the circular and rectangular cross sections this is straightforward, some care is needed for the definition of the O-shaped and Egg-shaped cross sections. For these two, a diameter D is specified, which is the width for the O-shaped cross section, and the height for the Egg-shaped cross section.



Egg-shaped pipe

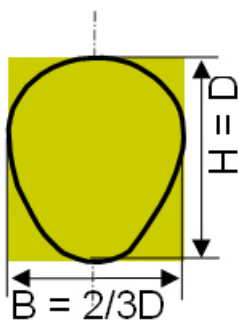

O-shape pipe

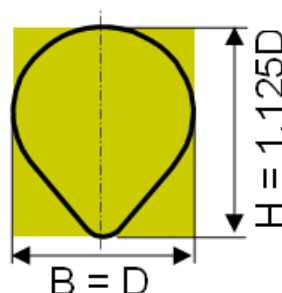

Figure 3.1 Egg-shaped and O-shaped cross sections. Note the difference in how the characteristic dimension D is used

3.2 User-specified Cross Sections

User-specified cross sections can be either open (river or canal) or closed (pipe).

The user-specified cross section is specified in raw form as a sequence of (x,z) coordinates, each coordinate being connected by a straight line to its neighbours in the sequence. The order of the coordinates is important, see Figure 3.2. Note that the x -coordinates need not be increasing.

If the cross section is closed, it is assumed that the first and last (x,z) coordinates are connected.



In MIKE+ (Collection System) it is also possible to specify a cross section in a height-width format. Height and width values are translated into (x,z) coordinates before being processed (converted to processed data by the engine). ■

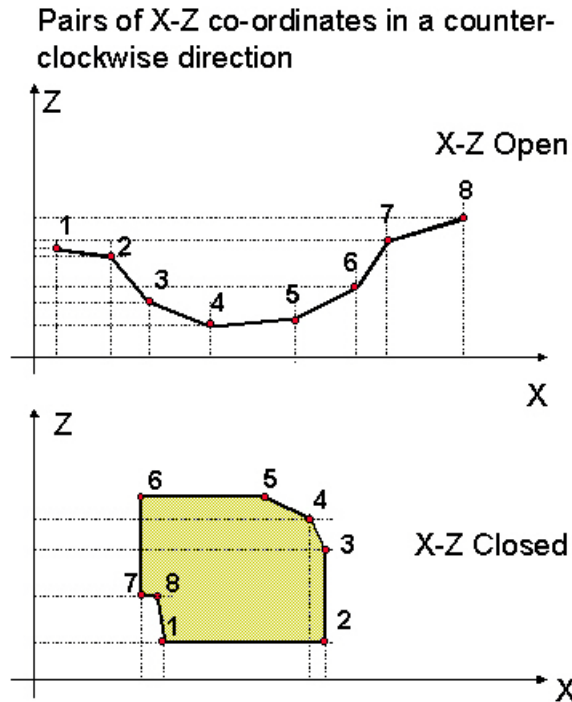

Figure 3.2 XZ Open and XZ Closed type cross sections

3.2.1 Markers on open cross sections

Markers are information attached to the (x,z) points and used when the engine converts raw data of open cross sections into processed data.

There are seven different markers, three of which are required:

1. *Left levee bank* (required)
2. *Lowest point* (required)
3. *Right levee bank* (required)
4. Left low flow bank
5. Right low flow bank
6. Left coordinate marker
7. Right coordinate marker

Markers 1 and 3 define the left and right edges of the cross section, respectively. Marker 2 defines the lowest point of the cross section, and markers 4 and 5 define the points where the banks of the cross section begin (the banks are typically the shallow area close to the edge). Markers 6 and 7 defines the



points in the cross section matching the coordinates that are used for determining the correction angle - they are not at presently used.

If no markers are specified, then the left levee bank is set to the first (x,z) point and the right levee bank is set to the last (x,z) point. The lowest point marker is set to the point with the lowest z value.



MIKE+ (Collection System) has a type of cross section called XZRM-Open. The data from MIKE+ contains coordinates of the cross section ((x,z) points), the relative resistance at those points (R) and markers (M). The resistance values are relative to the resistance Manning's M value specified for the link in MIKE+. ■

3.3 Resistance Specification

Flow resistance, in river applications called *bed resistance*, defines how easily the water flows through a cross section. The resistance depends on a number of physical characteristics; for instance on the material of the cross section (plastic/concrete), the vegetation (grass) and variations in shape along the reach that are too small to be represented in the model.

There are several resistance formulations

- Manning's M/n
- Chezy
- Darcy-Weisbach
- Colebrook-White for circular pipes
- Hazen-Williams

Each formulation enters the flow equations in the momentum equation, Equation (4.1b), as the resistance term. The actual implementation of the resistance term varies with the formulation, details are given in Section 4.3.

The formulations are introduced in Section 3.3.3 to Section 3.3.7

In real world situations the wall/bed roughness and thereby the resistance number varies with the water depth, due to changes in material, vegetation, erosion, sediment deposits etc. over the cross section. The resistance also depends on the flow conditions that the cross section has been exposed to during its lifetime.

The engine supports the following variations of the resistance number:

- Constant, i.e. no variation
- Depth-variable
- Distributed
- Flow bank zones



- Multi zone (triple zone)

The depth variabilities are discussed in Section 3.3.8 to 3.3.11.

3.3.1 Relative resistance numbers

Resistance numbers for a cross section can be specified relative to the resistance number in the HD parameters. Then the resistance formulation will follow the formulation set in the HD parameters.

Relative resistance numbers higher than one always correspond to higher physical resistance, i.e. independent of the choice of resistance number type in the HD parameters.

The effect of the relative resistance values on the hydraulic parameters in the processed data is dependent on which type of hydraulic radius is used. For details, see Section 3.4.2.

3.3.2 Calibration of resistance numbers

Values for the resistance numbers should be determined through model calibration where possible, or based on other calibrated models with similar topographical characteristics. A rough guide to values of Manning's n can be found in most publications dealing with open channel hydraulics, e.g. /11/.

Note that resistance numbers from a calibration based on a resistance radius, R_* , should not be directly transferred to a model using the hydraulic radius, R_h , and vice versa. It is, therefore, not recommended that a combination of resistance and hydraulic radius be used for different cross sections in a model setup, as this could lead to different calibrated resistance numbers between similar reaches, and other problems. The formulations for resistance and hydraulic radius is discussed further in section 3.4.2.

3.3.3 Manning formulation

The application of Manning's formula uses a friction slope:

$$I_f = f q |q| \quad (3.1)$$

with the friction factor:

$$f = \frac{1}{M^2 A_{\text{ref}}^2 R^{4/3}} \quad (3.2)$$



where M is the Manning resistance number, A_{fl} the flow area, and R the hydraulic radius. Conveyance is defined as

$$K = MA_{fl}R^{2/3} \quad (3.3)$$

The unit of the Manning M is $m^{1/3}/s$. The Manning number, M , is equivalent to the *Strickler coefficient*. It is the inverse of the Manning n , i.e.

$$M = \frac{1}{n} \quad (3.4)$$

The value of n is typically in the range 0.01 (smooth) to 0.1 (thickly vegetated/very rough bottom). The corresponding values for M are from 100 to 10.

3.3.4 Chezy formulation

The application of the Chezy formulation uses the friction slope:

$$I_f = fq|q| \quad (3.5)$$

with the friction factor:

$$f = \frac{1}{C^2 A_{fl}^2 R} \quad (3.6)$$

where C is the Chezy resistance number, A_{fl} the flow area, and R the hydraulic radius. Conveyance is defined as

$$K = CA_{fl}R \quad (3.7)$$

The unit of the Chezy number C is \sqrt{m}/s

The Chezy coefficient is related to the Manning coefficients by (13/):

$$C = \frac{R^{1/6}}{n} = MR^{1/6} \quad (3.8)$$

The difference between the Chezy and Manning descriptions is the power of R . The Manning description gives a formulation where the value of M can, in general, be considered as independent of the depth of water, while for the Chezy formulation the value of C varies with the depth, as implied by Equation (3.8).



3.3.5 Darcy-Weisbach formulation

The Darcy-Weisbach resistance number is specified in the form of an *equivalent grain diameter*, k_s .

The engine converts the Darcy-Weisbach resistance number to a Chezy resistance number, and uses the Chezy formulation during simulations. The relation between the Chezy C and the dimensionless Darcy-Weisbach resistance number λ reads:

$$C^2 = \frac{8g}{\lambda} \quad (3.9)$$

The dimensionless λ relates to the grain diameter, k_s as follows:

$$\frac{1}{\sqrt{\lambda}} = -2 \cdot \log_{10}\left(\frac{k_s}{14.84R}\right) \quad (3.10)$$

where R is the hydraulic radius. With some rearrangements it becomes:

$$C = -2 \cdot \sqrt{8g} \cdot \log_{10}\left(\frac{k_s}{14.84R}\right) \quad (3.11)$$



The additional resistance due to vegetation can be entered in the Cross Section Editor and will impact the processed data. ■

3.3.6 Colebrook-White formulation for circular pipes

In 1939, Colebrook and White derived an approximate formula which unifies the description of the turbulent flow in both rough and smooth circular pipes. This formula is extensively used for the computation of flow resistance in predominantly full-flowing pipe networks.

According to Colebrook and White, the friction factor f is computed iteratively, using one of the several formulations known from the literature. The formula implemented currently reads:

$$\sqrt{\frac{2}{f_{cw}}} = cw_1 + cw_2 \cdot \ln\left(\frac{cw_3}{Re} \sqrt{\frac{2}{f_{cw}}} + cw_4 \cdot \frac{k}{R}\right) \quad (3.12)$$

where:

k = the equivalent wall roughness [m],
 R = the hydraulic radius,



Re = the Reynolds number,
 cw_1, cw_2, cw_3, cw_4 = empirical constants.

The default values of the constants cw_1 - cw_4 are:

$cw_1 = 6.4$
 $cw_2 = -2.45$
 $cw_3 = 3.3$
 $cw_4 = 1.0$



In MIKE+ (Collection System), the default values can be modified through DHIAPP.INI file. See Appendix D.3. ■

The actual friction slope is calculated by using the following relation:

$$I_f = f_{cw} \cdot \frac{q|q|}{2gA^2R} \Rightarrow f = \frac{f_{cw}}{2gA^2R} \quad (3.13)$$

The Colebrook -White friction resistance can only be used if an implicit friction formulation is activated.

Use of the Colebrook-White formula must be restricted to circular reaches only. Also, the Colebrook-White formula is fully valid for full-flowing pipes.

3.3.7 Hazen-Williams formulation

The Hazen-Williams equation is an empirical formula which relates the flow of water in a reach with the physical properties of the reach and the pressure drop caused by resistance. It is used in the design of water pipe systems such as fire sprinkler systems, water supply networks, and irrigation systems. The Hazen-Williams equation has the advantage that the resistance number C is not a function of the Reynolds number, but it has the disadvantage that it is only valid for water and it is not able to account for temperature or viscosity.

$$Q = k \cdot C \cdot A \cdot R^{0,63} \cdot S^{0,54} \quad (3.14)$$

where:

k = is a conversion factor for the unit system ($k = 1.318$) for US customary units, $k = 0.849$ for SI units),
C = is the roughness coefficient,
R = is the hydraulic radius,
S = is slope of the energy line (head loss per length of pipe)

The slope of the energy line S is used as the friction slope I_f .



3.3.8 Depth-variable resistance number

The engine accepts a specification of a non-linear variation of the resistance number, based on a relative water depth. Three parameters define the resistance number variation: a bottom value, a full flow value and a non-linear exponent. Intermediate values are calculated by the expression, here for Manning's M :

$$M_{act} = M_{bot} + (M_{top} - M_{bot}) \cdot \left(\frac{y}{D}\right)^{exp} \quad (3.15)$$

where:

| | | |
|--------------------|---|--|
| M_{act} | = | calculated resistance number, |
| M_{bot}, M_{top} | = | resistance numbers at bottom/top of cross section, |
| exp | = | variation exponent, |
| y | = | the current water depth in the cross section |
| D | = | Height of cross section. |

The formula is used for relative depths h/D in the interval 0.0 - 1.0. For relative depth > 1.0 the actual value is set to the M_{top} value.

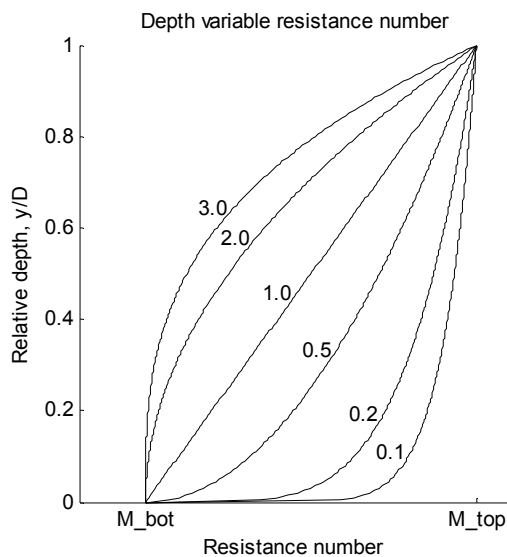

Figure 3.3 Relative variation of the Manning number with relative depth

The variation between M_{bot} and M_{top} is controlled by the “variation Exponent”. The variation of the resistance number in relative terms is illustrated in Figure 3.3.



In MIKE+ (Collection System), the Manning number variation is specified through the ASCII file *.ADP. The specified Manning numbers in the *.ADP file must follow the selected option for the Manning number convention. Syntax of the format of the *.ADP files must be as shown in the 'DHIAPP.INI and *.ADP Reference Manual'.

The lines of the *.ADP file related to the Manning number variation may be easily compiled by copy-and-paste operations from the MOUSE650.OUT file. This ASCII file is generated by every computation with the MOUSE Pipe Flow Model.

Before using the *.ADP file, the Manning number parameters for the selected lines must be modified, i.e. values for bottom and top of pipe Manning numbers and possibly the variation exponent must be adjusted for the pipes or canals where varying Manning numbers are to be used. ■

3.3.9 Distributed resistance numbers

For user specified cross sections, the resistance number can be specified on each (x,z) point of the raw data. The resistance number entered on data point number i will be applied on any volume above the line segment between data point $i-1$ and i .

The processing of the raw data will create the resistance numbers actually used by the engine, see Section 3.4 for details.

3.3.10 Flow bank zones

An open cross section can take flow banks into consideration when calculating the resistance number. In this case you must specify the resistance numbers for the left bank, the right bank and the main river (called "low flow zone").

The left bank resistance number is used between marker 1 and 4, and the right bank resistance number is used between marker 5 and 3. In the remainder of the cross section, the main resistance number is applied. If marker 4 or 5 is not set, the left or right bank resistance number will not be used.

The flow zone specification is an alternative way of specifying distributed resistance numbers.

3.3.11 Multi zone resistance specification

It is possible to specify a set of vertical zones based on either water depth or water levels, where the resistance number is constant within each zone.

The multi zone resistance parameters are specified in the HD Parameters.



In MIKE 11 it is called *triple zone*, since 3 zones can be specified. The zone separators are based on water levels. These are specified in the HD Parameter Editor, under the “Bed Resist” tab. ■

3.4 Processing of Raw Data

Cross sections specified by raw data are automatically converted into processed data (this is called *processing*). Processing creates processed data tables, which are used by the engine for flow computations. The processed data tables contain the following columns

| | | |
|----------|---|------------------------------|
| h | = | water level or depth, [m] |
| b_s | = | storage width, [m] |
| A_{fl} | = | flow area, [m ²] |
| F | = | resistance number, |
| R | = | hydraulic radius, [m] |

The *processing specification* contains the minimum and maximum water levels within which to process data, and optionally the number of processed levels to create. The processed levels can either be generated automatically, in which case the level spacing will be decided by the processing algorithm, it can be an equidistant number of levels, or the processed levels can be provided as part of the processing specification.

For each processing level the processed data table column values are calculated. The storage width b_s and the flow area A_{fl} are computed directly from the geometry of the cross section. The resistance number F and hydraulic radius R depend on the resistance specification of the cross section and are described in detail in the following sections.



In MIKE+ (Collection System) by default processes it cross sections using 50 equidistant levels. ■



For MIKE 11 processing can be performed by the cross section editor and stored in the xns11 file. If processed data is not stored in the xns11 file, the engine processes cross sections using the same algorithms as the cross section editor. ■

3.4.1 Relative resistance and effective area

When relative resistance is specified for a cross section, the effect of the relative resistance number, r , is included in the hydraulic radius R and the flow area A_{fl} , while the processed resistance numbers F by default are constant 1 for all levels.

If the hydraulic radius type used is either “Resistance Radius” or “Hydraulic Radius, Effective Area”, an effective area is calculated. The effective area tries to take into account the amount of water that due to resistance is not giv-



ing any contribution to the momentum, and is used in the Momentum Equation (4.1b), instead of the geometric area.

The effective flow area, A_e , for a given water level is defined as:

$$A_e = \int_0^B \frac{y}{r} db \quad (3.16)$$

where, y is the local water depth and B is the width of the cross section at the given water level.

Looping over all line segment in the cross section profile (which equals the number of raw (x,z) values minus one), this converts to a sum on the form

$$A_e = \sum_i \left(\frac{A_i}{r_i} \right) \quad (3.17)$$

where A_i is the area above the i 'th line segment up to the current water level, and r_i is the relative resistance specified for the line segment.

In case the relative resistance value is constant 1 along the entire cross section profile, the effective area will equal the geometric area.

The effect on the hydraulic radius will be described in the next section.

3.4.2 Hydraulic radius

The hydraulic radius is a measure of the effect of the wall/bed resistance on the water volume. The larger the hydraulic radius, the larger amount of water is affected by each metre of the wall; there is thus less friction and the reach will convey water more efficiently.

The hydraulic radius is traditionally defined as

$$R_h = \frac{A}{P} \quad (3.18)$$

where A is the cross section and P is the length of the *wetted perimeter*. The wetted perimeter is the portion of the cross section perimeter that is currently wet.

The traditional definition of the hydraulic radius has some properties that are not desirable in all situations. Therefore a number of variations exist, and the hydraulic radius used can be one of three different types:

- Resistance radius
- Hydraulic radius, effective area



- Hydraulic radius, total area

The two types of hydraulic radii, effective area and total area, are alike except when specifying a relative resistance number which varies along the cross section profile, either as distributed resistance numbers or using flow bank zones.

The hydraulic radius is calculated from the raw data. The following sections describe how the hydraulic radius is calculated.

Resistance radius

The resistance radius at a given water level is calculated as (/16/):

$$\sqrt{R_*} = \frac{1}{A} \int_0^B y^{3/2} db \quad (3.19)$$

where, y is the local water depth, A is the flow area and B is the width of the cross section at the given water level.

This formulation ensures that the resistance number is almost independent of the water depth in cases with significant effects from the flow bank zones.

Relative resistance

If relative resistance is specified, the flow area in Equation (3.19) is replaced by the effective area, and it is updated to read:

$$\sqrt{R_*} = \frac{1}{A_e} \int_0^B \frac{y^{3/2}}{r} db \quad (3.20)$$

In case the relative resistance number is constant over the cross section, Equation (3.20) simplifies to Equation (3.19).

Hydraulic radius for relative resistance numbers

When relative resistance is specified, the hydraulic radius is calculated based on a parallel channel analysis where the total conveyance, K , of the cross section at a given elevation is equal to the sum of the conveyances of the parallel channels. The parallel channels of a cross section are defined as those parts of the cross section where the resistance number remains constant. We have

$$K = \sum_{i=1}^N K_i \quad (3.21)$$



where N is the number of parallel channels.

The parallel channel analysis is based on a Manning's n formulation, hence:

$$\frac{AR^{2/3}}{n} = \sum_{i=1}^N \frac{A_i R_i^{2/3}}{n r_i} \quad (3.22)$$

Setting A equal to either the effective flow area as given by Equation (3.17) or the total flow area, we get the general formula:

$$R_h = \left(\frac{1}{A} \sum_{i=1}^N \left(\frac{A_i^{5/3}}{r_i P_i^{2/3}} \right) \right)^{3/2} \quad (3.23)$$

where, P_i is the wetted perimeter of the parallel channel. P_i does not include the interface between adjoining parallel channels, i.e. a zero shear interface has been adopted.

Resistance Radius vs. Hydraulic Radius

The choice between R_* or R_h should be based on

1. which factor appears to be the most appropriate from a hydraulic aspect, and
2. which factor is normally used in local practice so that conventional bed resistance numbers can be used with confidence.

For a technical analysis Lundgren and Jonsson, /24/ present a comparison of five different methods for determining the shear stress distribution over the bed of a shallow channel.

To highlight the differences between R_* and R_h the following example is used. Consider the cross section shown in Figure 3.4. In the case of a constant relative resistance of 1.0 over the cross section, Table 3.1 gives the values of R_* and R_h (Case 1), and their corresponding conveyance, K , (defined here as $AR^{2/3}$) at selected water levels.



Table 3.1 Conveyance calculation for resistance radius R_* and hydraulic radius R_h for both total and effective area

| Elev [m] | Area [m ²] | R_* [m] | K | R_h [m] Case 1 | K | R_h [m] Case 2 | K |
|----------|------------------------|-----------|-------|------------------|-------|------------------|-------|
| 100.0 | 0.0 | 0.00 | 0 | 0.00 | 0 | 0.00 | 0 |
| 103.0 | 101.7 | 2.19 | 171 | 1.89 | 155 | 1.89 | 155 |
| 106.0 | 306.3 | 4.41 | 824 | 3.27 | 675 | 3.27 | 675 |
| 106.1 | 344.6 | 3.85 | 846 | 0.89 | 319 | 2.98 | 714 |
| 107.0 | 697.1 | 2.95 | 1434 | 1.74 | 1009 | 2.62 | 1325 |
| 108.0 | 1104.8 | 3.46 | 2527 | 2.64 | 2110 | 3.18 | 2389 |
| 110.0 | 1970.5 | 5.03 | 5780 | 4.36 | 5259 | 4.66 | 5498 |
| 113.0 | 3395.0 | 7.58 | 13100 | 6.75 | 12126 | 6.93 | 12340 |

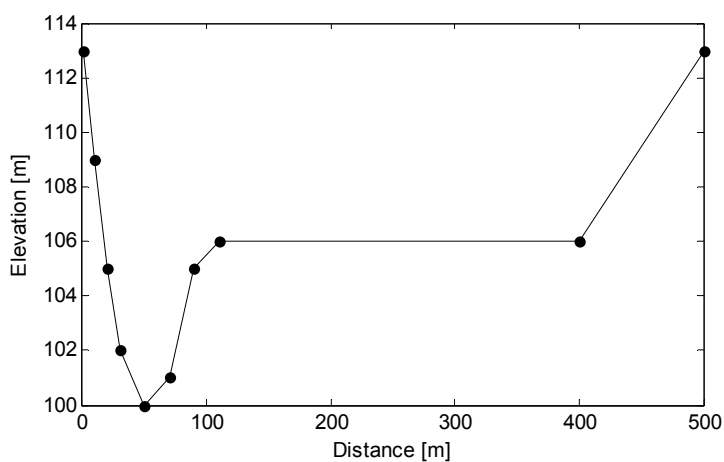

Figure 3.4 Cross Section used in the comparison of resistance radius R_* and hydraulic radius R_h

The comparison of the conveyance values, shown in Figure 3.5, provide a guide as to how the hydraulic capacity of the section varies with the water level. The figure shows that:

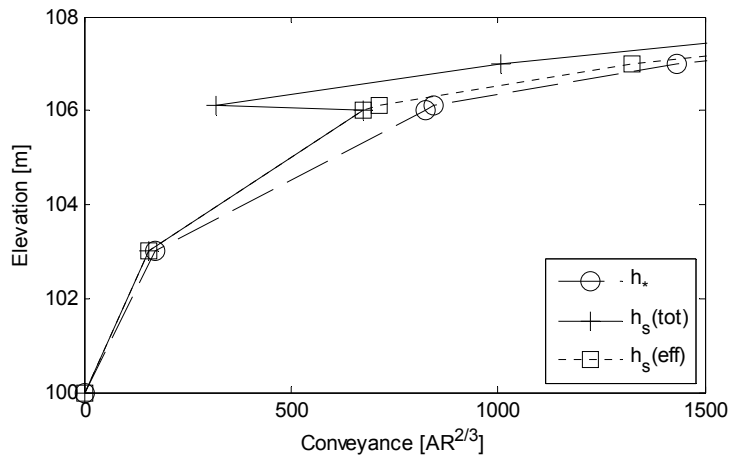

Figure 3.5 Plot of conveyance with surface elevation

1. R^* allows a smooth transition in the conveyance of the channel as the over bank region becomes flooded, while R_h causes a sharp, incorrect decrease in the conveyance;
2. The conveyance in the deep sections is considerably greater for $R = R^*$. This is because R^* can over-estimate the conveyance for very deep and narrow cross sections as it does not fully take into account the friction from the cross section sides as does the R_h formulation.

The conveyance curve for the R_h case can be improved by separating the cross section illustrated in Figure 3.4 into two parallel channels (main channel and over bank channel) separated by an apparent third channel of zero width at a distance of 110 m along the x axis. This can be done by specifying a change in relative resistance where the two parallel channels meet - which in reality is the norm as the over bank channel typically would have a higher resistance than the main channel. R_h - Case 2 in Table 3.1 is in the case of a r_r of 1.1 specified for the channel of zero width, and r_r of 1.0 elsewhere. (This has the effect of splitting the section into three parallel channels with the conveyance of the middle channel being zero.) As can be seen in Figure 3.5 a much improved conveyance -elevation relationship results.

In general, R^* is suited to sections with significant variations in shape such as over bank flow paths, while R_h , with no variation of r_r (i.e. one parallel channel) is more appropriate for very deep and narrow uniform sections. For R_h , where over bank flow paths occur, adjustment of r_r should be made to invoke the parallel channel analysis facility as described above. For wide sections with little variation in depth, R^* and R_h will not differ greatly.



In the cross section editors processed Data menu a conveyance column is shown where the conveyance is defined as follows:



For Manning's number

$$K = r_f AR^{2/3} \quad (3.24)$$

where r_f is the resistance factor.

This is a useful facility for checking that the conveyance is increasing with increasing height. The conveyance can also be plotted to check a smooth representation. ■

3.4.3 Calculation of processed resistance numbers

For cross sections where the resistance number is varying over the cross section profile, the calculation of processed resistance numbers for a given water level is based on a similar parallel channel analysis as in previous sections. For a given water level, the following procedure takes place:

1. The resistance numbers are converted to relative resistance numbers.

The resistance number with the largest resistance is found, and all resistance numbers are scaled with that, such that all resistance numbers are in the range from 0 to 1. Note that for resistance formulations where the largest resistance number gives the smallest resistance, like Manning's n formulation, the number found is the smallest resistance number. For Manning's M and n and Chezy formulation, the largest resistance number is found like:

$$M_{max} = \max(M_i), \quad \frac{1}{n_{min}} = \max\left(\frac{1}{n_i}\right), \quad C_{max} = \max(C_i) \quad (3.25)$$

and the relative resistance numbers are then

$$r_i = \frac{M_i}{M_{max}}, \quad r_i = \frac{n_{min}}{n_i}, \quad r_i = \frac{C_i}{C_{max}} \quad (3.26)$$

2. The effective area and hydraulic radius are calculated as described in Section 3.4.1 and 3.4.2 using these relative resistance numbers.

The hydraulic radius using the effective area, i.e. it is either "resistance radius", or "hydraulic radius, effective area". These will be denoted A_e and R_e .

3. The area and hydraulic radius are calculated once more, this time using a constant relative resistance of 1 on the entire cross section, giving a



total area and radius. These will be denoted A_{tot} and R_{tot} .

4. The effective resistance number for the given water level is the maximum resistance scaled with the effective vs. total conveyance fraction:

$$M_p = M_{max} \frac{A_e R_e^{2/3}}{A_{tot} R_{tot}^{2/3}} \quad (3.27)$$

$$n_p = n_{min} \frac{A_{tot} R_{tot}^{2/3}}{A_e R_e^{2/3}} \quad (3.28)$$

$$C_p = C_{max} \frac{A_e \sqrt{R_e}}{A_{tot} \sqrt{R_{tot}}} \quad (3.29)$$

3.4.4 Manual modification of the resistance factor

The variation of resistance number with elevation is stored in the resistance number column of the processed data. These can be modified by hand, if another vertical variation of the resistance number is desired.

If the cross section specifies relative resistance, the resistance number is a resistance factor. It is by default defined as 1.0 for all water levels. When a resistance number is required by the engine, the global constant resistance number is multiplied by this resistance factor. The effect of this resistance factor on the resistance number is dependent on the friction formulation used. In case of Chezy and Manning's M , an increase in the resistance factor will cause a decrease in resistance, while for Manning's n an increase in the resistance factor will increase the resistance.

3.4.5 Processing of user specified cross sections from MIKE+



MIKE+ (Collection System) user-specified cross sections are processed with 50 equidistant levels, covering the bottom to the top of the cross section. For open cross sections, the top is defined by the lowest of the two bed levels.

For open cross sections, a top slot is not set by default, meaning that if the water level exceeds the level of one of the bed sides, the simulation will stop. It is possible to modify the default behaviour and extrapolate the processed cross section data upward by from the DHIAPP.INI file.

For closed cross sections, a top slot is set: an additional 50 levels are added to the existing processed levels. The top few levels of the existing 50 levels are updated to assure a smooth transition from the first 50 levels to the 50 levels of the top slot levels. On top of the 100 levels, a top slot is added that



extends to infinity but which returns constant values for cross section area, width and hydraulic radius. The constant values are taken from the processed data at the level where the top slot begins (Constant ARW top slot, see Section A.4.6). ■

3.4.6 Conveyance modifications

To ensure computational stability, the cross section conveyance should monotonically increase or be constant for increasing water levels.

This is normally not the case with pipes; for pipes, the values of conveyance drop in the region near the top of the cross section.

For such cases, when raw data is used, the hydraulic radius is adjusted as part of the processing so that the limiting conveyance for the cross section corresponds to the actual conveyance value for the full profile. Figure 3.6 and Figure 3.7 shows the effect of the correction on the conveyance and hydraulic radius for a circular pipe cross section with a radius of 1.5 m.

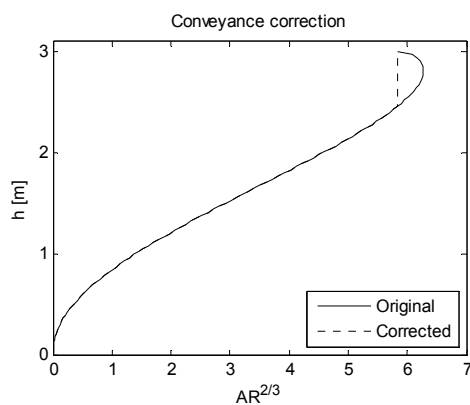

Figure 3.6 Corrected conveyance curve

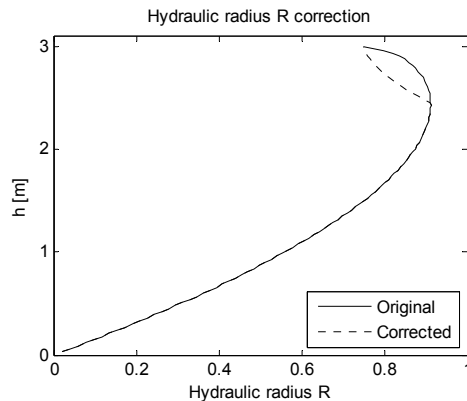

Figure 3.7 Corrected hydraulic radius

When closed cross section processed data are used or manually edited, attention should be paid to the upper region of the profile, so that decreasing conveyance is avoided.

When using the cross section editor this is accomplished by monitoring the conveyance column in the processed data table; the conveyance should be monotonically increasing with increasing water level.

3.5 Top Slot

When the water level exceeds the maximum water level in the processed data table, behaviour is defined by the top slot. There are several different types of top slots:

- No slot; the simulation will terminate if water level rises above the top level of the cross section.
- *Vertical wall*; assuming the river banks extend vertically upwards, see Figure 3.8. Thus, the width remains constant for increasing water levels.
- *Angle wall*; assuming the river banks extend upwards at a specified angle. For positive angle, straight sides extend upwards, slanting out from the centre of the cross section. Thus, the width increases for increasing water levels. For negative angles, the cross section sides slant inward and the cross section becomes narrower for increasing water levels.
- *Constant ARW*; area, hydraulic radius and width are considered constant all the way up through the slot, having the value of the top of the cross section.

The vertical wall and angle wall top slots are intended for open cross sections. Their primary use is to prevent simulations from terminating should any initial instabilities occur. They should not be used to accommodate a lack of



knowledge concerning the cross section geometry, see Figure 3.8. The simulation is terminated if the water level becomes more than N times higher than the height of the cross section, where N by default is 4.



The default value for N can be changed in the ini file for MIKE 11, 'MIKE11.ini', see D.2. ■



The angle for the angle wall top slot can be changed in the MIKE+ (Collection System) ini file, 'dhiapp.ini'. ■

The constant ARW top slot is intended for closed cross sections and is vital when pressurised flow are considered, see Section 4.2. See Section A.4.6 for details of the AWR top slot.

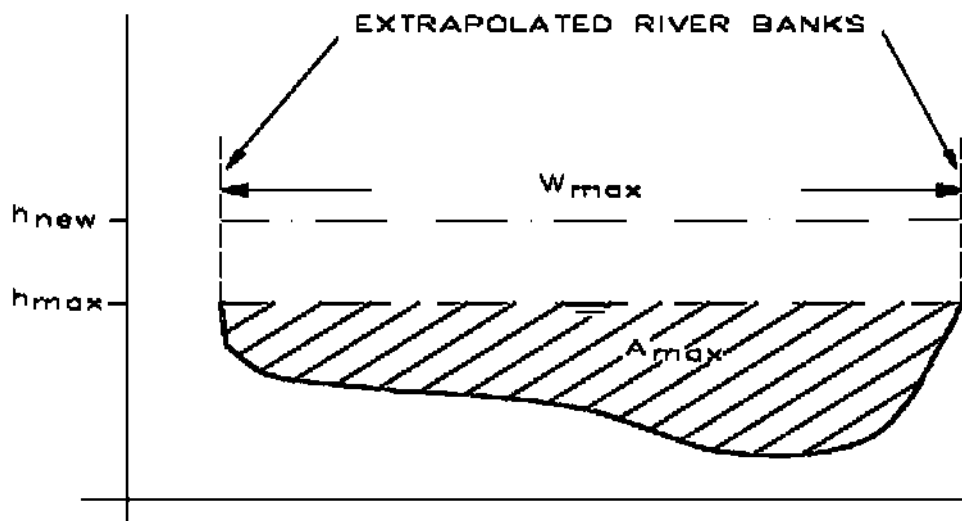

Figure 3.8 The vertical wall top slot above maximum specified height. The vertical wall and angled wall top slots should not be used in place of inadequate knowledge about cross section geometry, but only to ensure numerical stability

When adding top slots for open cross sections, it is strongly recommended that, in defining the cross section geometry, the maximum elevation is specified in such a way that the cross section will accommodate the maximum expected water levels. The top slot is for “emergency” situations only.

3.6 Bottom Slot

In order to ensure numerical stability, a cross section must never have a zero storage width and never become dry (zero water volume.)



This requirement is met by extending the cross sections with a bottom slot for water levels below the physical shape of the cross section.

Two types of bottom slots are supported:

- Classical bottom slot
- *Area preserving bottom slot.*

Both types start Δh above the cross section bottom and extend to $6\Delta h$ below the cross section bottom.

For details, see Section A.4.5.1 and A.4.5.2.

3.7 Flooded Areas and Relative Resistance

Open cross sections can represent as well the main river, as the flooded areas on each side of the main river. If flood areas are represented, then the upper levels of the cross sections are significantly wider than the parts of the cross section representing the main river.

Care is required if the resistance is specified as relative resistances that varies along the cross section profile, and a resistance formulation based on effective area. Then the cross section should be defined such that the water level does not rise above the maximum level of the cross section, i.e. such that the water does not enter the top slot.

The reason is, that the area in the cross section processed data table, and thus used by the engine in the Momentum Equation (4.1b), is the effective area, which is somewhat smaller than the total geometrical area. If water levels rise above the maximum water level in the cross section, properties of the top slot will be used. The top slot calculates width and area based on the geometry of the cross section, and will not take the effect of the varying relative resistance into account: It will assume that the area increases with the geometrical width. This is illustrated in Figure 3.9a and Figure 3.9b, which depict the same cross section with a different maximum cross section level h_{max} . In Figure 3.9a, h_{max} is below the highest occurring water level. Then the area added in the top slot part does not account for the relative resistance, giving an incorrect effective area. In Figure 3.9b, h_{max} is higher than the highest occurring water level and the effective area is correctly calculated.

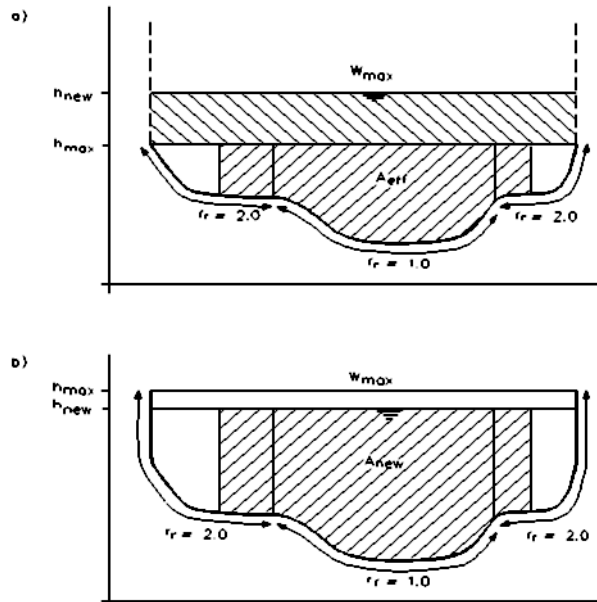

Figure 3.9 Calculation of cross section area for relative resistance not equal to 1.0. a) Highest water level above top of cross section, b) highest water level below top of cross section

Under these circumstances then the top of the cross section (h_{max}) should be specified to be above the maximum water level encountered in the simulation.



4 Hydrodynamic Module

The 1D engine solves the problem of water flowing through a network of reaches, nodes, and structures. The problem is fully specified by boundary conditions at the network boundaries and initial conditions.

4.1 Saint-Venant Equations

Solving the problem of an arbitrary flow of water through three dimensional canals is computationally impractical. Fortunately, the geometry of pipes and canals allows for a set of approximations, which naturally fit the problem space. The approximations rely on the following assumptions:

- Water is incompressible and homogeneous, i.e., it has negligible variations in density
- The bottom slope of pipes and canals is small, so that the cosine of the angle it makes with the horizontal may be taken as 1.
- Wave lengths are large compared to the water depth. This ensures that the flow everywhere can be regarded as having a direction parallel to the bottom, i.e. vertical accelerations can be neglected and a hydrostatic pressure variation along the vertical can be assumed.
- There is no acceleration of water perpendicular to the flow direction of a reach.

With these assumptions, two simplified equations can be derived from the Navier-Stokes equations, which are usually called the *Saint-Venant equations*, or *Shallow Water equations*:

$$\frac{\partial q}{\partial x} + \frac{\partial A_{fl}}{\partial t} = q_{in} \quad (4.1a)$$

$$\frac{\partial q}{\partial t} + \frac{\partial \left(\alpha \frac{q^2}{A_{fl}} \right)}{\partial x} + g A_{fl} \frac{\partial h}{\partial x} + g A_{fl} l_f = \frac{f}{\rho_w} \quad (4.1b)$$

where,

- q : discharge
- A_{fl} : Flow area, also called cross section area
- q_{in} : lateral inflow (per length unit)
- h : water level
- α : momentum distribution coefficient



- I_f : flow resistance term, in the form of a friction slope
 f : momentum forcing (per length unit)
 ρ_w : density of water

Equation (4.1a) is called the *mass equation* or *continuity equation* and expresses conservation of mass; the volume of water which is added, ∂q , in reach section of length ∂x , is balanced by an increase in cross section area ∂A_{fl} (volume).

Equation (4.1b) is called the *momentum equation* and expresses conservation of momentum; the first two terms on the left side of the momentum equation represent the inertia forces (local and convective acceleration), the third term represents pressure forces due to gravity, and the last term represent resistance/friction. The right-hand side represents an external momentum forcing.

There are different formulations of the flow resistance term in equation (4.1b), which are described in Section 4.3.

The derivation of equations (4.1a) and (4.1b) is given in numerous text books on hydrodynamics. A version is also provided in Appendix A.1.

The Saint-Venant equations are only valid for free surface flows. Since pressurised flow in closed reaches is an important part of the 1D problem space, an approximate treatment of pressurised flow has been adopted. The approach is described below in Section 4.2.

To solve the Saint-Venant equations, a finite difference scheme is implemented. An overview of this scheme is given below in Section 4.4, and a more detailed description is provided in Appendix A.2. This solution scheme is only accurate for sub-critical flows (Froude number less than 1). For super-critical flows (Froude number larger than 1), a simpler approximation where non-linear terms are suppressed provides an accurate flow description. Section 4.5 below describes how the transition to super-critical flow is handled.

Finally, it should be noted that the solution scheme does not include a detailed description of *hydraulic jumps*. However, flow conditions both upstream and downstream of a hydraulic jump are accurately described.

4.2 Pressurised Flow

If a closed reach runs full of water (flow depth equal to reach height), then a basic assumption for the derivation of the Saint-Venant equations is not valid since the flow changes from the free surface flow to the pressurised flow.

However, it is possible to generalise the equations for free surface flow, so that the pressurised flow in closed reaches is covered. This is done by introducing a fictitious slot in the top of the reach, see Figure 4.1.

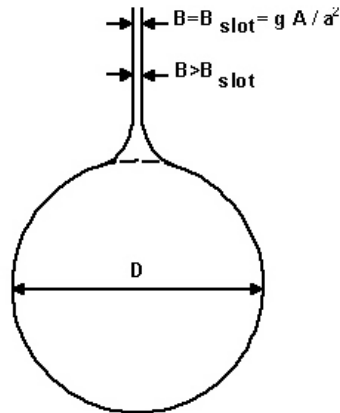

Figure 4.1 Circular reach with a fictitious top slot, usually referred to as a Preissmann slot

The theoretical background can be found in Appendix A.1.1.

4.2.1 Smooth transition to top slot

In order to obtain a smooth transition between the free surface flow computations and pressurised flow computations, it is necessary to apply a “soft” transition between the actual reach geometry and the fictitious slot. Such a “smooth” transition has been designed based on a series of tests with various slot configurations. The slot configuration thus obtained ensures stable computations without affecting the accuracy significantly. Note that the applied slot width in general is larger than the theoretical value.

4.2.2 Pressure reaches



MIKE+ setups can have parts of a network defined as *pressure reaches*. A pressure reach can connect to other pressure reaches upstream or downstream. If a pressure reach does not connect to another pressure reach it must connect normal reaches through a downstream pump and a *pressure reach tail node* upstream. A pressure reach section of the network can only contain one pressure reach tail node. Nodes internal to a pressure reach section of the network are assumed to be *sealed*.

Pressure reaches are always pressurised, meaning that the water level is in the top slot of the cross sections in the reach.

The equations governing flow through a pressure reach are slightly modified to ensure stability of flow through the reach. The time derivative terms in the q -grid points is suppressed. In addition, a weir function is approximated on the h -grid points that connect to the pressure reach tail node. ■

4.3 Resistance

The resistance defines how “easily” the water flows through a cross section. The higher the resistance, the more the water is slowed down and a higher water level slope is required to obtain a certain flow velocity.

The resistance term is introduced in the momentum equation (4.1b) in the form of a friction slope I_f . The friction slope can be derived as a function of an appropriate combination of the flow parameters (Q , A and R) and the water and resistance properties.

Generally, the friction slope is expressed as:

$$I_f = f \cdot q|q| \quad (4.2)$$

where f is a generalised friction factor. The exact form of the friction factor depend on the resistance formulation, and can be found in Chapter 3.

By these means, the friction slope is explicitly determined as a function of instantaneous values of local flow parameters.

4.4 Numerical Schemes

The schemes used to solve the Saint-Venant equations are based on an implicit finite difference scheme developed by Abbott and Ionescu (1967). Here, we provide an overview of the schemes. Details are given in Appendix A.2.

A computational grid of alternating *q-grid points* (discharge) and *h-grid points* (water level) points is used as illustrated in Figure 4.2 (see also Section A.2.1). The computational grid is automatically generated on the basis of the user requirements. *q-grid points* are placed midway between neighbouring *h-grid points* and at structures, while *h-grid points* are located at cross sections, or at equidistant intervals in between if the distance between cross sections is greater than a user-specified maximum distance. The sign of the discharge is defined by convention as positive in the positive x-direction (increasing chain-age).



In MIKE+ setups, the maximum distance between grid points is calculated automatically from the height of the reach, its slope, etc. for reaches without a user-defined topography. Lower reaches will have smaller distances between grid points to ensure stability. ■

The conservation of mass equation, Equation (4.1a), is approximated on h-grid points and the conservation of momentum, Equation (4.1b), is approximated on q-grid points.



Equations (4.1a) and (4.1b) are converted into a system of coupled equations, which are solved to find the water depth and discharge throughout the network. The solution algorithm is referred to as the *double sweep* algorithm. See [2] for details.

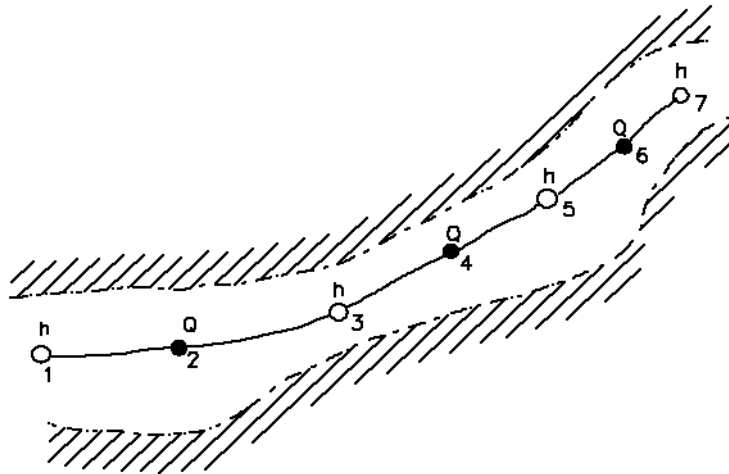

Figure 4.2 Reach section with h- and q-grid points, on which the Saint-Venant equations are solved

There are different methods for approximating the momentum equation. The MIKE 11 and MIKE+ interfaces give the user control over which approximation method to use. See Appendix A.2.1.2 for details on how the different methods are implemented.



In MIKE 11, the *Diffusive wave approximation* and the *Kinematic wave approximation* can be selected as methods for solving the momentum equation.

The diffusive wave description ignores the inertia terms and is therefore suitable for 1) backwater analyses, 2) cases where the bed resistance forces dominate, and 3) for slowly propagating flood waves where the change in inertia is negligible. It is not normally suitable for tidal flows.

This formulation still ensures a backwater description through the $\partial h/\partial x$ term. For stability reasons the $\partial h/\partial x$ term is dampened in the solution, which means that only relatively steady backwater phenomena (compared to the time step) are resolved.

In the kinematic wave approximation, a balance between the friction and gravity is assumed and the discharge becomes a function of upstream water level alone. This means that the kinematic wave approach cannot simulate backwater effects. Thus this description is appropriate for relatively steep rivers without backwater effects.



The diffusive and kinematic wave approximations are simplifications of the full dynamic descriptions. They are implemented to offer improved computational efficiency, but should only be used when the omitted terms have insignificant influence. When there is any doubt it is better to use the full dynamic description or trials should be undertaken to establish the difference between alternative methods, and advice sought from experienced persons. It is very important to have a solid understanding of the influence of the different terms.

None of the three wave descriptions includes detailed hydraulic descriptions of hydraulic jumps. However, the chosen formulations ensure a correct description upstream and downstream of the jump.

4.4.1 Multiple threads can influence results

The underlying numerical scheme uses a matrix equation solver that supports multiple CPUs (meaning that the solver will take advantage of all available cores in a computer).

Please note that if more than one thread is used, then the matrix solver does not guarantee the same result every time the solver is run (the reason is that the order of steps in the algorithm can be different). The difference in the results is normally so small that it can safely be disregarded. However, if the setup is **unstable** and conditions are unfavourable, then very small differences can be amplified and the results can differ markedly from simulation to simulation. Thus, if a situation is encountered where results differ from simulation to simulation, then it is recommended running the simulation with only one thread.

Please also note: If a situation is encountered where results differ markedly from simulation to simulation, then the result can most likely not be trusted, even if they are reproducible with only one thread. The real solution to the problem of different results from simulation to simulation is thus to ensure that the simulation is stable.

4.5 Super Critical Flow

The Saint-Venant equations are accurate in the fully dynamic wave approximation only for subcritical flow conditions, i.e. for Froude numbers less than 1. In supercritical flow conditions, a more stable and accurate flow description is obtained by suppressing inertia forces in the conservation of momentum equation (the second term in equation (4.1b)). Even though this approach increases stability for supercritical flow, it should be noted that the 1D solution scheme is more accurate at low Froude numbers (less than 1) than at higher Froude numbers.



4.5.1 Convection suppression factor

The characteristics of the Saint-Venant equations are given by

$$C_{1,2} = \frac{q}{A_{fl}} \pm \sqrt{gA_{fl}/b_s} = \frac{q}{A_{fl}} \left(1 \pm \frac{1}{F}\right) \quad (4.3)$$

For $F > 1$ the characteristics are both positive, implying that the Saint-Venant equations take two upstream boundary conditions, and for $F = 1$ the solution becomes singular. The numerical algorithm adopted is based on a staggered computational grid and cannot accommodate two boundary conditions at the same boundary and cannot handle a singular solution. To avoid these situations a modified momentum equation is implemented:

$$\frac{\partial q}{\partial t} + \beta \frac{\partial \left(\alpha \frac{q^2}{A_{fl}} \right)}{\partial x} + gA \frac{\partial h}{\partial x} + gA f_r |q| = f \quad (4.4)$$

where β is a convection suppression term dependent on the Froude number. The default formulation is

$$\beta = \begin{cases} 1 - F^2 & \text{for } F \leq 1 \\ 0 & \text{for } F > 1 \end{cases} \quad (4.5)$$

This ensures excellent stability properties of the numerical solution and is sufficiently accurate for most flood routing studies, where generally the Froude numbers are relatively small and the resolution used is coarse ($\Delta x \gg h$). The suppression term is shown in Figure 4.3.

For water surface profiles with high a Froude number and small space steps ($\Delta x = O(\text{water depth})$) an alternative formulation has been implemented:

$$\beta = \begin{cases} 1 & \text{for } F \leq a \\ 1/(F+1-a)^b & \text{for } F > a \end{cases} \quad (4.6)$$

For the default value of a and b ($a=1$ and $b=2$) the two characteristics never have the same sign; when $F < 1$ they have different signs, and when $F \geq 1$ then one is zero. The variation of β is shown in Figure 4.3.

The alternative formulation is somewhat less stable than the default, Equation (4.5), and therefore requires the application of a smaller time step for high Froude numbers. The solution is, however, considerably more accurate for high Froude numbers. Various tests have shown that the alternative for-

mulation performs well for the transition from sub- to supercritical flow, whereas hydraulic jumps are less accurate.

Note that a and b can be adjusted and do not necessarily have to be set at $a=1$ and $b=2$. However, the solution scheme is unstable if the suppression factor β lies to the right of the dashed curve shown in Figure 4.3. Thus $a=0.5$ and $b=2$ can be applied, but $a=2$ and $b=2$ cannot.

The same factor (β) is used to gradually centre the evaluation of the differentials upstream as the flow approaches supercritical conditions.

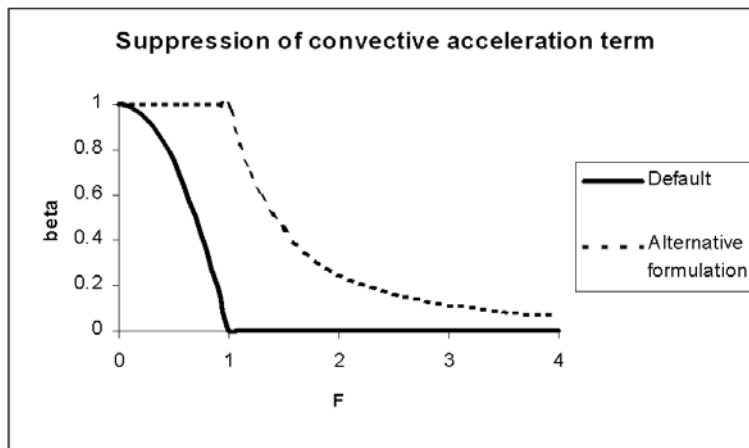

Figure 4.3 The Convection suppression term (beta) as a function of the Froude number. Beta is used for the gradual reduction of the convection term during transition to supercritical flow (Froude number larger than 1)

4.5.2 Effect of convection suppression on energy heads

As discussed, when the solution scheme approaches critical conditions the convective momentum term is gradually reduced. The suppression factor β varies from 1 (full convective term) to 0 (no convective term) according to the Froude number.

The β factor also modifies the energy calculation, thus energy head at any location in a model is affected. This means that when velocities are high (when the convective term is significant), the energy head is significantly affected by the value of beta. This can be seen in a profile plot of energy levels along a river reach, which shows that energy is not conserved and varies according to velocity.



4.6 Headloss in Nodes

Headloss is an *energy loss* when water rushes through a node. Physically, headloss occurs because of

1. a change in water elevation
2. a change in water flow direction
3. expansion or contraction of the flow

Since headloss is a property of the flow in nodes, headloss is always zero for nodes without a volume, the junction nodes (river junctions).



Since MIKE 11 uses only river nodes, which have zero volume, headloss is not included in MIKE 11 simulations. ■

Energy losses in nodes are of the same order of magnitude as those caused by resistance in reaches. Knowledge gained from experimental data about the magnitude of these energy losses is limited, but some theoretical results are available (e.g. ref. /4/). The importance of a detailed evaluation of these losses is related to the relative length of the links (l/D), and grows with relative shortening of the conduits.

The headloss calculation method adopted in the 1D engine is based on F.A. Engelund's energy loss formulation (see ref. /3/). The method ensures that mutual dependence of the flows in reaches and hydraulic conditions in nodes are correctly resolved, even for complex branched and looped networks.

To ensure numerical stability, the final applied headloss is a weighted sum of the calculated headloss and the actual headloss from the previous time step:

$$\Delta E_{\text{applied}} = w\Delta E + (1 - w)\Delta E_{\text{prev}} \quad (4.7)$$

The default value of the weighting factor w is 0.2.

4.6.1 Headloss is applied as water flows out of nodes

Mathematically, headloss is applied to the water flow as it runs *out of* a node. This means that a headloss will manifest itself as a change in the water level between a node and the first h-grid point in the downstream connecting reach (flow direction).

The 1D engine assumes equal water levels in nodes and their *incoming* reaches. In extreme cases this assumption might not be valid. Therefore, if the headloss in nodes is crucial in order to achieve a correct solution, then it is advisable to perform a detailed analysis of the approximate errors introduced by this assumption.



Sometimes, a drop in water level can be observed as water runs *into* a node. In the 1D engine, this drop is always caused by natural flow or critical flow into the node, and *not* by headloss in the node.

4.6.2 Headloss calculation for inflowing water

Water loses energy as it flows *into* a node. Depending on conditions, this energy loss can be negligibly small, or significant.

Therefore, the 1D engine has an option to fully ignore this energy loss and to set the energy of the water in a node equal to that of the incoming reach (or the weighted average if there are several inlets). Without doubt, this approach proves valuable for some specific situations, particularly for the flow-through manholes with 'normal' flow conditions. However, due attention must be paid to cases with high inlet energy levels, e.g. a small pipe with high-velocity flow entering a large basin. In such cases, the energy level of otherwise still water in the basin would be calculated as equal to the energy level of the approaching flow, i.e. much higher than in reality, with erroneous results as a consequence.

If inlet headloss is included in the simulation, then it is calculated in the following way: it is assumed that the water level in the node is equal to the water level in the incoming reaches. The change in energy (head) is then given by the change in water velocity:

$$\Delta E_i = \frac{v_i^2 - v_m^2}{2g} \quad (4.8)$$

for inlet reach i and the node m .

The velocity in the inlet is known, while the velocity in the node must be calculated:

$$v = \frac{Q}{A_{fl}} = \frac{Q}{(H - H_b) \cdot D} \quad (4.9)$$

where Q is the discharge through the node and A_{fl} is the flow area in the node. On the right-hand side of equation (4.9), the flow area is calculated as the area of a circular manhole, where H is the water level in the node, H_b is the node bottom level, and D is the node diameter. Note that a uniform horizontal velocity distribution is assumed.

Effective flow area calculation

The flow area calculated as above in equation (4.9) $((H - H_b) \cdot D)$ gives a very conservatively low estimate of the velocity, which will result in a conserv-



atively low energy loss in the node. This in turn will cause higher water levels in the node than will be observed in reality.

An alternative formula for a more realistic calculation of the flow area in nodes is available, however only for “flow-through” nodes with one inlet reach and one outlet reach. The alternative formulation is based on the assumption that the inflow behaves like a submerged jet, which entrains water from the ambient fluid and increases the discharge through the node. The angle of entrainment is approximately 6.8° . The cross section area of the jet thus depends on the distance from the inlet.

As a generalisation, it is assumed that the effective flow area in the node equals the cross section area of the jet at the outlet. This is valid in the case of no change in direction from inlet to outlet. It is calculated as:

$$A_{fl} = A_{jet} = \frac{\pi}{4} \cdot D_{in}^2 \cdot \left(1 + 2 \cdot \frac{D}{D_{in}} \cdot \tan\left(\frac{6.2}{360} \cdot 2\pi\right)\right)^2 \quad (4.10)$$

where D_{in} is the height of the inlet reach (the diameter for circular reaches).

So far, the alternative formula is only applicable for manholes with one inlet and one outlet with different diameters. However, there are other causes for headloss. The 1D engine also calculates a headloss from a change in elevation and a change in flow direction from inlet to outlet.

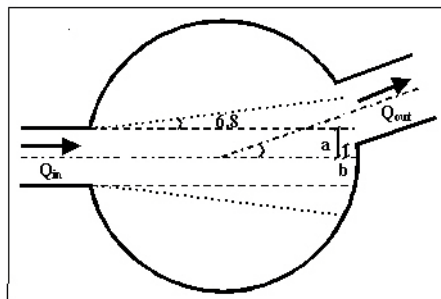

Figure 4.4 Manhole with one inlet, one outlet and a change in flow direction

In the case of a change in flow direction, the effect of the jet at the outlet will gradually diminish with increasing angle. The effective flow area is therefore linearly interpolated between the full cross section area of the node, A , and the area of the jet, A_{jet} , as the angle increases.



The distance, a , from the point where the jet intercepts the node to the centreline of the inlet, see Figure 4.4, is conservatively calculated as half the diameter of the inlet, D_{in} , thus neglecting the entrainment angle of 6.8° .

$$a = \frac{D_{in}}{2} \quad (4.11)$$

The distance, b , from the point where the side of the outlet enters the node to the centreline of the inlet, is approximated with:

$$b = \max\left(0, \frac{D}{2} \cdot \tan\left(\frac{\theta}{360} \cdot 2\pi\right) - \frac{D_{out}}{2}\right) \quad (4.12)$$

where θ is the angle between the centrelines of the inlet/outlet and D_{out} is the diameter of the outlet reach.

In the case of a change in elevation the effective flow area is diminished with a factor, *drop_factor*, which is equal to 1 when the inlet flows directly into the outlet and 0 when there is no interception between the incoming jet (calculated conservatively without the entrainment angle) and the outlet. In between these two conditions the drop factor is interpolated linearly.

The effective flow area is then interpolated as:

$$A_{fl} = A_{jet} \cdot \left(1 - \frac{b}{a}\right) \cdot \text{drop_factor} + \left(1 - \left(1 - \frac{b}{a}\right) \cdot \text{drop_factor}\right) \cdot A_{fl} \quad (4.13)$$

For a straight inlet/outlet with no change in elevation the formula gives that the effective flow area equals the jet area.

4.6.3 Headloss calculation for outflowing water

Headloss as water flows out of a node is calculated separately for each outlet link. The outlet loss for the link j is assumed to be proportional to the velocity head in the outlet link j :

$$\Delta E_j = \sum_k \zeta_{jk} \cdot \frac{v_j^2}{2g} \quad (4.14)$$

where ζ_{jk} are individual headloss coefficients for link j , calculated on the basis of the geometry of the node and flow distribution among the links attached to the node.



Loss due to change in flow direction

This loss is a function of the angles between the inlet and outlet links and distribution of the discharge in the inlet and outlet links, as shown in Figure 4.5 and Figure 4.6.

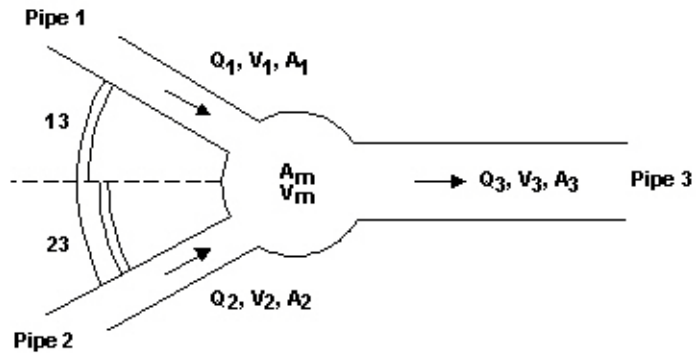

Figure 4.5 Example of manhole with two inlets and one outlet

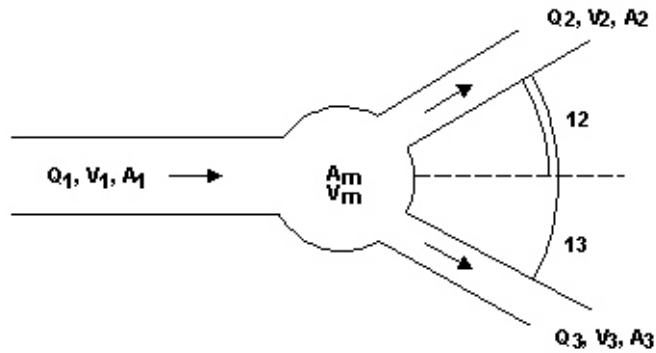

Figure 4.6 Example of manhole with one inlet and two outlets

Based on the generalised notation, the calculation of the headloss coefficient is performed individually for each outlet link as follows:

$$\zeta_{dir(j)} = \sum_{i=1}^n \frac{Q_i}{Q_{totalOut}} \cdot \frac{\theta_{ij}^2}{90^{\circ 2}} \quad (4.15)$$

where i stands for inlet links, and j stands for outlet links.

Loss Due to Change in Elevation

Vertical changes in flow direction occur and cause energy losses if there is a difference in elevation between the inlet and outlet links. These losses are described considering the magnitude of the difference in elevation, see Figure 4.7.

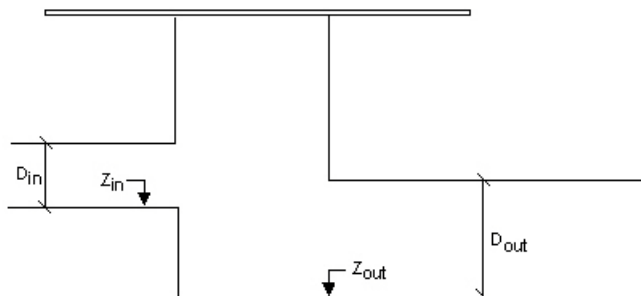

Figure 4.7 Manhole with a difference in elevation between inlet and outlet pipe

The individual headloss coefficient is calculated according to the following expression, where the weighting relative to the flow rates in the inlet links relative to the outlet link is also included:

$$\zeta_{level(j)} = \sum_{i=1}^n \frac{Q_i}{Q_{totalOut}} \cdot \frac{(Z_j - Z_i) \cdot (Z_j + D_j - Z_i - D_i)}{D_i \cdot D_j} \quad (4.16)$$

If the calculated headloss coefficient is smaller than 0, a zero value is assumed.

Loss Due to Contraction

The flow leaving the manhole and entering the outlet conduit is more or less contracted and due to subsequent expansion there occurs an energy loss. The outlet headloss coefficient depends on the shape of the manhole outlet, manhole and the link cross sections and distribution of flow among multiple inlet and outlet links.



The outlet headloss coefficient are calculated as:

$$\zeta_{contr(j)} = \min \left(1, K_m \left(1 - \frac{A_j}{A_m \cdot \frac{Q_j}{\sum_{i=1}^n Q_i}} \right) \right) \quad (4.17)$$

where:

- K_m = specified outlet 'shape' coefficient for the node. For relatively large basins, K_m approaches ζ_{contr} .
- A_m = flow cross sectional area in the node.

Limiting the contraction headloss to 1 helps to ensure numerical stability.

4.6.4 Limiting the total headloss for outflowing water

Theoretically, the total energy loss at the outlet from the node, expressed as a function of the velocity head in the outlet pipe can be as high as the available energy level in the node. The limiting case occurs e.g. with a completely clogged outlet ($K_m \rightarrow \infty$), with no flow in the outlet pipe.

To ensure numerical stability of the computation, the maximum headloss is limited to the depth in the outlet pipe:

$$\Delta E_j = \min \left[h_j \left((1 + \zeta_{out}) \cdot \frac{v_j^2}{2g} - \frac{v_m^2}{2g} \right) \right] \quad (4.18)$$

4.6.5 Selecting an appropriate local headloss computation



This entire section applies to MIKE+ type setups only.

In some cases, results from using different approaches for headloss calculation can differ considerably, and due attention must be paid to the selection of the most appropriate approach.

The headloss calculation for individual nodes can be controlled by selecting one of five available options.

Each option is characterised by the fundamental computational principle and by a number of parameters which control the behaviour of the algorithm or the size of loss coefficient. In MIKE+, the existing options can be modified and new options created in "Outlet Headloss" dialog. Furthermore, the actual



headloss calculation for individual nodes can be controlled by a local specification of various relevant parameters.

Constitutive Parameters of Headloss Computation Options

The following parameters constitute a definition of headloss calculation option:

Computation Method

Three different methods are available:

- *MOUSE Classic (Engelund)*
- *Weighted Inlet Energy Method*
- *No Headloss Calculation*

The first two are described in detail above in Section 4.6.2.

The third option ignores all local losses. Regardless of the shape of the outlets, the geometry of the junction or the distribution of flows among inlet and outlet conduits, water levels at the junction and the outlet conduit are set to the same value, as if there is no change in geometry and no change in the flow conditions between the junction and outlet conduit. This literary means that this option should be applied only where there is no change in cross section. If applied inappropriately, inconsistent results may be generated. This option can be recommended for use if an artificial node is introduced somewhere on a straight section of a reach, where no actual losses occur.

Maximum Loss Limit

This parameter is of relevance for both MOUSE Classic and Weighted Inlet Energy computation methods. It limits the maximum computed headloss to the water depth or the velocity head in the outlet pipe, according to Section 4.6.4.

Loss Coefficient

The available loss coefficient types distinguish three different interpretations of the specified headloss coefficient.

Selection of " K_m " (Type (a)) interprets the specified value as the outlet 'shape' coefficient K_m (see Equation (4.17)).

Selection of "*Contraction HLC*" (Type (b)) interprets the specified value as the outlet 'contraction' coefficient $z_{contr}(j)$ (see Equation (4.17)). This means that the model ignores the geometrical relations between the node and the outlet links (outlet shape), and applies the specified value directly as the z_{contr} . The contraction losses in the outlet links are then computed by multiplying the velocity head in the respective link by the z_{contr} . The total headloss for an outlet link is computed as a sum of the contraction, direction and elevation loss.



Selection of “*Total HLC*” (Type c)) interprets the specified value as the total outlet headloss coefficient (z_{out}). This means that the model completely ignores the geometry of the node/links, and applies the specified value (Total HLC) directly as the z_{out} , the same for all outlet links at the node. The total headlosses in the outlet links are then computed by multiplying the velocity head in the respective link by the specified z_{out} .

Effective Node Area

This parameter is only relevant for the MOUSE Classic computational method and for flow-through manholes in circular pipes. In all other cases, the default total wetted node area is applied. The following choices are available:

- *Total wetted node area*: calculated as product of the diameter and water depth for manholes and read from the basin geometry table (A_c) for basins. Typically results in overestimation of local headloss in a node
- *Calculated Effective Area*: the effective area in a manhole is calculated on the basis of empirical formula (see Section 4.6.2 Headloss calculation for inflowing water (p. 58)). This results in a significantly smaller area than the full wetted area and, consequently, in a more realistic flow calculation
- *Reduced Calculated Effective Area*: the effective area in a manhole is further reduced to 50% of the calculated effective area

Default Computational Options

The following tables provide an overview of available headloss calculation options in MOUSE and MIKE+. By comparing the two tables, it is possible to identify the equivalent options. During the import of a MOUSE project into MIKE+, the nine options are imported under their original names with the prefix “MOUSE_”.

| MOUSE DEFAULT OPTIONS | Method | Loss Limit | Coefficient Type | Coeff. | Effective Node Area |
|-------------------------|--------------------------|---------------|------------------|--------|---------------------|
| Round Edged | Classic | Water depth | Km | 0.25 | Full |
| Sharp Edged | Classic | Water depth | Km | 0.5 | Full |
| Orifice | Classic | Water depth | Km | 0.5 | Full |
| No CRS Changes (1) | No head loss calculation | n/a | n/a | 0 | n/a |
| Energy Loss | Classic | Velocity head | Km | 0.5 | Full |
| No CRS Changes (2) | No head loss calculation | n/a | n/a | 0 | n/a |
| Effective Flow Area (1) | Classic | Water depth | Km | 0.25 | Calculated |
| Effective Flow Area (2) | Classic | Water depth | Km | 0.25 | Reduced calculated |
| Mean Energy Approach | Weighted Inlet Energy | Water depth | Km | 0.25 | Full |

| MIKE URBAN DEFAULT OPTIONS | Method | Loss Limit | Coefficient Type | Coeff. | Effective Node Area |
|-----------------------------------|--------------------------|---------------|------------------|--------|---------------------|
| MOUSE Classic (Engelund) | Classic | Water depth | Km | 0.25 | Full |
| MOUSE Classic (Engelund)-Modified | Classic | Velocity head | Km | 0.25 | Full |
| Flow Through Manhole | Classic | Water depth | Km | 0.25 | Calculated |
| No Cross Section Changes | No head loss calculation | n/a | n/a | 0 | n/a |
| Weighted Inlet Energy | Weighted Inlet Energy | Water depth | Km | 0.25 | Full |

Figure 4.8 Headloss options in MOUSE and MIKE+

Example: Variation in Node Outlet Headlosses as a Function of the Headloss Coefficient Mode

In this example a simple sewer system consisting of two pipes, two manholes and one outlet is constructed. Tests for different types of headloss (a), (b) and (c) have been performed with various modifications in flow direction or drop height, or both. Table 4.1 shows a complete test matrix.

Four variants of the model setup have been constructed:

- I) Straight sewer pipelines with no drops and no changes in directions.
- II) A change in direction is introduced in variant I).
- III) A drop is introduced in variant I).
- IV) A drop and a change of direction are introduced in variant I).

A definition sketch of the setups I)-IV) is shown in Figure 4.9. The manual calculation example corresponds to test No. 4 in the test matrix.

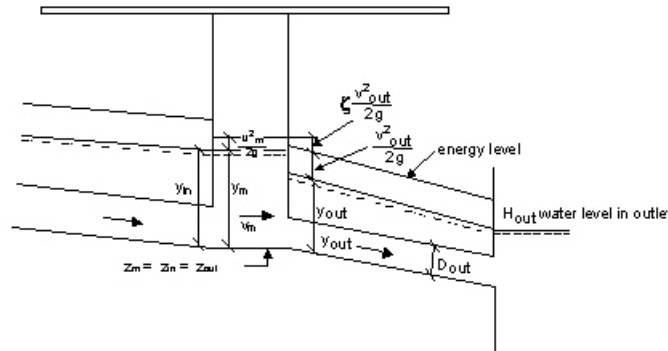

Figure 4.9 Sketch to define the various terms of the example

In the performed tests, the value of the HEADLOSS COEFFICIENT has been set to 0.5 for all three types (a), (b) and (c). The headloss coefficients for a drop in the setup III) and IV) is 0.4 (inlet pipe is 0.6 m above the bottom in manhole B). The headloss for the direction in the setup II) and IV) is 0.25 (angle between pipes are 45°).

The example also includes the calculation of the friction loss in the downstream pipe.

Manual Headloss Calculation

Assumptions:

The water level in the inlet pipe is assumed to be equal to the water level in the manhole. This implies that the expansion loss at the inlet is automatically assumed. All calculated energy losses are assumed to occur at the outlet pipe, i.e.:

$$E_{manhole} = E_{pipe} + \Delta H \quad (4.19)$$

or expressed by using the notation in Figure 4.9:

$$\frac{v_m^2}{2g} + y_m + z_m = \frac{v_{out}^2}{2g} + y_{out} + z_{out} + \zeta \frac{v_{out}^2}{2g} \quad (4.20)$$

ζ = a coefficient expressing the total outlet energy loss (see Section 4.6.3 Headloss calculation for outflowing water (p. 60)).

Data:

| | | | | |
|-------------------------|-----------|---|-----|-------------|
| Discharge | Q | = | 2.0 | m^3s^{-1} |
| Diameter in outlet pipe | D_{out} | = | 1.0 | m |
| Diameter in manhole | D_m | = | 1.5 | m |



| | | | | |
|---|-----------|--------|------|-------------------------------|
| Velocity in outlet pipe (Q is capacity assumed) | V_{out} | \sim | 2.55 | ms^{-1} |
| Length of outlet pipe | L | $=$ | 50.0 | m |
| Manning number | M | $=$ | 70 | $\text{m}^{1/3}\text{s}^{-1}$ |
| Water level in outlet | H_{out} | $=$ | 15.0 | m |
| Bottom level in manhole | Z_m | $=$ | 14.0 | m |
| Head “shape” loss coefficient | K_m | $=$ | 0.5 | |

Friction loss in outlet pipe from manhole to outlet:

$$h_f = \frac{Q^2 L}{M^2 A^2 R^{4/3}} = \frac{2.0^2 \cdot 50.0}{70^2 \cdot 0.7854^2 \cdot 0.25^{4/3}} \quad (4.21)$$

The water level in the manhole (H) can be found from:

$$H + \frac{v_m^2}{2g} = H_{out} + h_f + \frac{v_{out}^2}{2g} + \zeta \frac{v_{out}^2}{2g} \quad (4.22)$$

v_m is approximated by assuming that $y_m = y_{out}$:

$$v_m = \frac{Q}{A_m} = \frac{Q}{D_m y_m} = \frac{2.0}{1.5 \cdot (15.0 + 0.42 - 14.0)} = 0.94 \text{ms}^{-1} \quad (4.23)$$

$$v_{out} = \frac{Q}{A_{out}} = \frac{2.0}{0.78} = 2.55 \text{ms}^{-1}, \quad \frac{v_{out}^2}{2g} = 0.33 \text{m} \quad (4.24)$$

$$\frac{v_m^2}{2g} = 0.045 \text{m} \quad (4.25)$$

$$\zeta = \zeta_{contr} + \zeta_{dir} \quad (4.26)$$

$$\begin{aligned} &= K_m \cdot \left(1 - \frac{A_{out} Q_{in}}{Q_{out} A_m}\right) + \frac{Q_{in}}{Q_{out}} \cdot \frac{\theta^2}{90^2} \\ &= 0.5 \cdot \left(1 - \frac{0.78}{1.5 \cdot 1.42}\right) + \frac{45^2}{90^2} = 0.567 \end{aligned}$$

Substituting values to the Equation (4.23) and calculating H yields:

$$H = 15.89 \text{m} \quad (4.27)$$



The deviation between the MOUSE simulation and manual calculation result is due to the fact that MOUSE calculates v_{out} by using the following area in the pipe:

$$A_{out} = \frac{D_{out}^2 \pi}{4} + \text{Preismann slot area}$$

The table shows which setups have been used for the calculation, and also which types of headloss are included. ζ_{c0} , ζ_{c1} , ζ_{c2} are all headloss coefficients due to contraction and correspond to the types (a), (b) and (c).

Table 4.1 Test matrix for implementation of Headloss Type

Table 4.2

| Test | Setup | Direction ζ_d | Drop ζ_l | Contraction ζ_c | | | H_{calc} | H_M |
|------|-------|---------------------|----------------|-----------------------|------------------|------------------|------------|-------|
| | | | | (a) ζ_{c0} | (b) ζ_{c1} | (c) ζ_{c0} | | |
| 1 | I) | | | X | | | 15.81 | 15.82 |
| 2 | I) | | | | X | | 15.87 | 15.87 |
| 3 | I) | | | | | X | 15.87 | 15.87 |
| 4 | II) | X | | X | | | 15.89 | 15.90 |
| 5 | II) | X | | | X | | 15.95 | 15.94 |
| 6 | II) | X | | | | X | 15.87 | 15.87 |
| 7 | III) | | X | X | | | 15.94 | 15.94 |
| 8 | III) | | X | | X | | 16.00 | 15.99 |
| 9 | IV) | X | X | X | | | 16.02 | 16.02 |
| 10 | IV) | X | X | | X | | 16.03 | 16.02 |

4.7 Low Flow Conditions

During low flow, the cross sections in some reaches may “dry out” (meaning that the water level falls below the reach bottom). Apart from other problems, this gives numerical difficulties which, if no special measures are taken, prohibits a continuation of the computation.

The problem is handled in the 1D engine by the aid of two numerical features:

1. A narrow slot below the cross sections is introduced so that the calculations can continue when the water surface falls below the bottom of the bed, see Section 3.6. If the water level reaches the bottom of the slot, a small amount of water is automatically added to prevent a complete drying out. The applied slot shape starts at a height DELH above the river bottom and extends to 5 x DELH below the river bottom (see

Figure 4.10), where DELH is a user specified parameter. The description above DELH over the river bottom is not affected by the slot. Below this point, the calculation of both A , R and b is affected as well as the weighting coefficients in the numerical solution. The computed conditions below this point should thus not be given much weight, but should be seen as a “stand-by” condition until flow starts again.

The geometry of the slot may be of two types: 1) the width varies as the square root of the depth in the slot or 2) the geometry is so that the cross sectional area is continuous across the local water level DELH. For the latter case the geometry does not introduce an error in the overall water amount as long as the water level does not reach the bottom of the slot. For details on the geometry of the slot please refer to Section A.4.5.2.

2. For low flow conditions the use of the Saint-Venant equation to describe the momentum balance is a unreliable model. This is handled by gradually substituting the momentum equation for low flow condition with a zero flow condition. This weighting is a function of the local water depth and is implemented in such a way that the zero flow condition has full weighting if the water level is less or equal to the local bottom level.

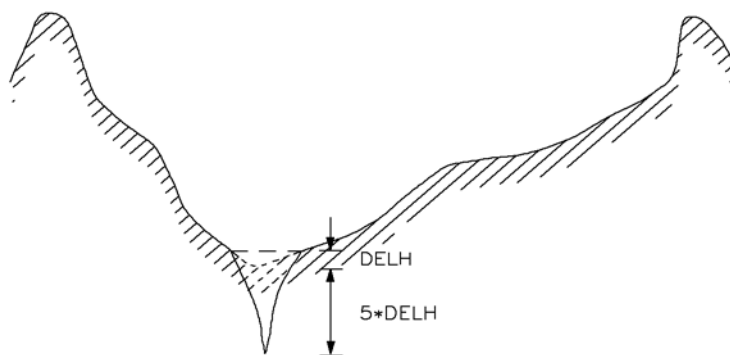

Figure 4.10 Reach cross section with an artificial bottom slot

If one of the two above-mentioned numerical features are active, then the user might be forced to decrease the time step. The gain being the increase in accuracy in the mass balance.

4.8 Flood Plains

When the water level in a river is high, the river will in some places increase dramatically in width as the water flows into relatively large flat areas next to the natural river bed. These areas are called *flood plains*, and they require care when modelling the river flow since the water typically flows much slower in flood plains than in the natural river bed.



Description of flow over flood plains can be achieved with several different types of model schematisations depending on the topography of the flood plain and the nature of the flow.

In spilling areas natural levees are formed along the river by sedimentation due to the abrupt reduction in flow velocity of the entering water. In predominantly drainage areas, these levees are not present. The principal difference between the two situations is shown in Figure 4.11

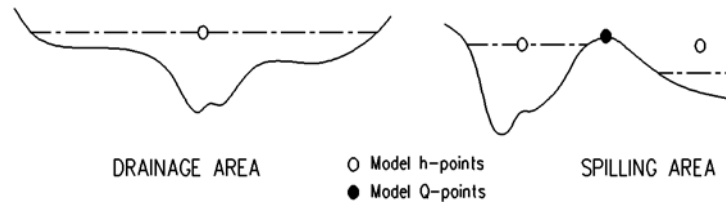

Figure 4.11 Cross section view of the drainage area (left) and spilling area (right)

This schematisation of the flood plain may not be adequate if sediment transport is to be calculated; especially where the hydraulic resistance in the flood plain is significantly different from that in the channel. This is because the sediment transport is very sensitive to the value of the velocity, and the average velocity across a cross section will not be representative of the actual velocity in the flood plain. For this situation, the river and flood plain may be schematised separately using two or more parallel model branches connected by broad crested weirs.

In a typical drainage area, it is generally reasonable to assume that the water level is the same in the river and on the flood plain. The flood plain storage can thus be included directly in the modelled river cross section through the cross section width, and only one model *h-grid* point is required to determine the water level over the whole area.

In a typical spilling area, the water levels in river and flood plain might differ due to separation by a levee. One *h-grid* point at each side of the levee is thus required to describe the situation. Between the two *h-grid* points a *Q-grid* point is placed that represents the discharge over the levee. A weir equation is applied to describe the magnitude of the discharge. This discretisation is shown in the right hand part of Figure 4.11. A schematic plan view of such a discretisation is shown in Figure 4.12.

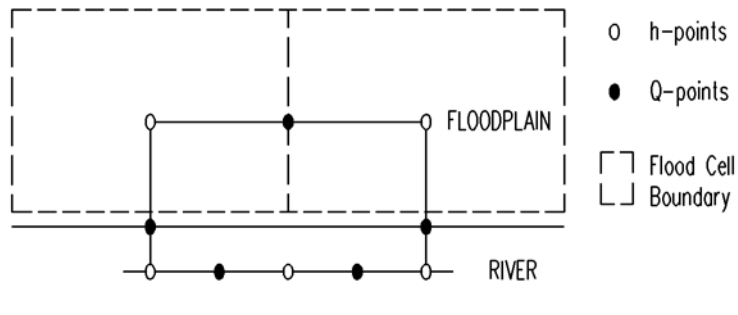

Figure 4.12 Top view of one possible method of discretisation with flood cells

If water flows along the flood plain then the momentum equation must also be modified. The flood plain is divided into cells with one *h-grid* point describing the water level in each cell. Over the flood plains, flow can take place from one cell to the next. This is described by introducing a model branch between the cells (see Figure 4.12). The boundaries between the cells are normally chosen along natural elevations such as roads or railway embankments. Where such features do not exist or are not sufficiently significant to merit explicit representation (but may be implicit in the flood plain roughness), the Saint-Venant equations can be applied. The water surface slope will then vary linearly between *h*-points.

If no cross section data exists on the flood plain, the cross section parameters can be derived from a storage-elevation relationship. From the storage-elevation relationship, the storage volume of the cell (denoted by V) can be determined as a function of elevation, and the area of the cross section in the flood cell can be approximated as:

$$A(h) = \frac{V(h)}{L} \quad (4.28)$$

where, L is shown in Figure 4.13.

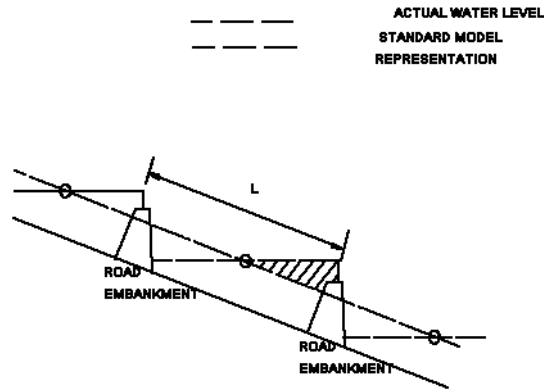

Figure 4.13 Side view of a Section showing cell discretisation around a road

This will represent a measure for the average cross section along the flood plain. The average resistance radius can similarly be approximated with:

$$R(h) = \frac{V(h)}{S(h)} \tag{4.29}$$

When spilling starts, huge flows of water may suddenly be generated across a wide weir, possibly causing numerical instabilities. This problem can be overcome by giving the levee along the river a V-formed shape in the mathematical description, see Figure 4.14.

This ensures that spilling starts gradually instead of instantaneously over the whole section. This corresponds, in fact, to the situation often encountered in nature, where irregularities in levee height cause the spilling to start as trickles at certain positions along the levee.



Figure 4.14 Side view of a V-formed levee. The V-form ensures that water gradually flows over the levee.

The computed water level in the cell is not representative for all locations within the cell, but is an average as shown in Figure 4.13. To interpret the



model results, the computed water level should be transformed into an average depth of inundation within the cell as given by:

$$\text{average inundation depth} = \frac{V(h)}{S(h)} \quad (4.30)$$

4.9 HD Parameters



See Appendix D.1 for a list of the MIKE 11 HD parameters supported by the 1D engine. ■

4.10 Initial Conditions

The HD Module needs initial conditions for the water level and the discharge.

The water level is initialised based on the following list, where the order of the list determines the condition that is applied, the top ones being “stronger” than the bottom ones.

1. Minimum water depth
2. State value
3. Hot-start value
4. Local initial value, also called parameter value
5. Flush in from outlets/water level boundaries
6. Flush out: fill up depressions
7. Minimum node levels from surrounding reaches
8. Global initial value
9. Empty system

Similarly for discharge:

1. State value
2. Hot-start value
3. Local initial value, also called parameter value
4. Natural flow condition
5. Global initial value

The initial conditions are set in the following order:



1. Empty system initialisation; all water levels are set to the minimum water depth, discharges to zero
2. State start is applied, if present. All other conditions are skipped if a start state is present
3. Hot-start, parameter start and global values are set, if present
4. Flush-out is applied, if activated
5. Flush-in is applied, if activated
6. Minimum node levels from surrounding reaches are applied, if activated
7. Natural flow is applied, if activated

4.10.1 Minimum water depth

The minimum water depth must always be satisfied, that is to say, if a condition sets a value below the minimum water depth, it is set to be the minimum water depth. For initial conditions this is the minimum water depth set in the HD parameters.



The default value for a MIKE 11 setup is the level of the bottom slot. Note that this is below the bottom level in the reach. ■



For MIKE+ setups, a default initial water depth equal to 0.5% (but not more than 0.005m) is used of the characteristic dimension of the conduit (diameter for circular pipes). For MIKE+ type nodes, the minimum water depth is the smallest of the minimum water depth and $\max(0.005 * \text{connecting pipe heights})$. ■



In cases of applications with initially dry systems (dry weather flow), the volume of artificially generated water may be significant compared to the dry weather flows. This may compromise the volume balance analysis. Therefore, in such cases the default minimum depth can be reduced by setting the parameters *BRANCH_MIN_H_REL* (controls the minimum depth relative to the conduit size) and *BRANCH_MIN_H_ABS* (controls the absolute depth of the minimum water depth) to appropriate values (in the DHIAPP.INI file). ■

4.10.2 Initial conditions provided state start

Not yet supported.

4.10.3 Local initial conditions / parameter values

Local initial conditions can be specified for certain reaches and nodes, in order to make the initial state as realistic as possible.



4.10.4 Initial conditions provided by hotstart

Initial conditions can be loaded from previously calculated model runs by specifying one or more result files. Values for the water level, discharge etc. is loaded from the result file at a specified time. Values at any time contained in the interval covered by the result file can be chosen as an initial condition. Such a result file used for initial conditions is called a hotstart file.

The result files used for hotstart do not have to cover the entire network. If the first hotstart file does not cover the entire network, the remainder of the network will be initialised by the next hotstart file, if present. If two or more hotstart files cover some part of the network, the first hotstart file specified in the list of hotstart files will be used. For parts of the network that are not covered by any hotstart file, a “weaker” initial condition type is applied.

A hotstart file does not need to match the input network exactly, i.e. the number of grid points in a reach can be different in the hotstart file and in the network. In that case interpolation is performed to calculate the values at the network grid points.

4.10.5 Flush out

Flush out is what happens if the network is completely filled and left alone until a steady state is reached, i.e., all depressions are filled up.

The flush out will only work if the network has at least one open boundary (water-level/QH etc.).

The flush-out levels used are the water levels defined on outlet/water level boundaries at simulation start time, or the bottom level for all other types of open boundary conditions.

If two boundaries flush the same part of the network, the lowest one wins. If there is already a weaker initial condition set (a global water level), the flush-out will not lower that value, only increase it.

Flush out is disabled by default.

4.10.6 Flush-in from boundaries

If water level boundaries/outlets in the system are specified with initial water level higher than the outlet bottom, it is assumed that a horizontal water surface extends inside the system, until the point in the system where the water level coincides with the bottom level (see Figure 4.15).

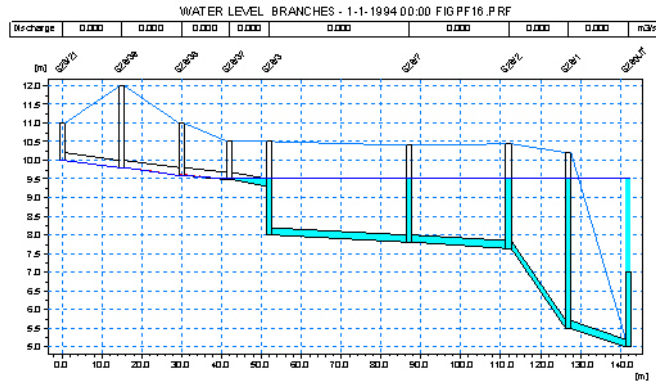

Figure 4.15 Initial conditions with backwater outlet (water has been flushed in from the boundary)

This procedure is called flush-in. The flush-in is also stopped if it meets a stronger initial condition.

Outlets/water level boundaries that are to be used as flush-in boundaries, must be marked as so.

The boundaries are flushed, with the lowest water level value flushed first. If two boundaries flush into the same part of the network (not recommended!), the highest water level “wins”.



The outlets from a MU setup are automatically marked for flush in. ■



No boundaries from a M11 setup are automatically marked for flush in. ■

4.10.7 Minimum node levels from surrounding reaches

Node levels can be corrected so that they are not lower than any of the surrounding reaches.

This is activated by default.



Disabled by default in MIKE 11 setups. ■

4.10.8 Natural flow

Natural flow can be calculated for grid points for which no stronger conditions have been set. The natural flow condition is based on the water level condition set in previous steps.

By default the natural flow is not activated.



In MIKE+ type setups, the natural flow is by default activated.

4.11 Wind Forcing

Wind friction on the water surface can be accounted for by inclusion of the wind shear stress in the momentum equation.

The wind shear stress τ_w is expressed as:

$$\tau_w = T_{fac} C_w \rho_a V_{10}^2 \quad (4.31)$$

where,

- T_{fac} : *topographical factor*
- C_w : *wind friction factor*, default value 0.0025
- ρ_a : density of the air, using value of 1.3
- V_{10} : wind velocity 10 m above the surface water

Taking the wind direction into account, the wind force is projected into the direction of the channel and included as a forcing in the momentum equation (Q-points) on reaches with open cross sections.

The wind direction and velocity can be specified as constant or time series. It is assumed that the wind direction is specified in the same coordinate system as the network.

The topographical factor is used to reduce the impact of the wind at locations that are sheltered from the wind, having a value of 1.0 for open areas, and 0.0 where the reach is completely sheltered from the wind. It can be defined globally or locally for each reach in the network.

The surface area to which the wind stress applies excludes any additional flooded areas and is equal to the width of the reach multiplied by the distance between h -points on either side of the Q-point



The topographical factor is specified in the Hydrodynamic editor under the "Wind" tab. The wind friction factor can not be specified, but are always given as the default value of 0.0025. The friction factor in the wind tab in the Hydrodynamic editor is the friction factor between stratified layers in the water col-



umn, and not for the air-water interface. The wind direction and speed are specified in the boundary editor as global and/or distributed boundaries, as either constants or time series. ■

4.12 Stability Conditions and Discretisation

The computational efficiency of any discrete-time numerical simulation algorithm is highly dependent on the time step and the spatial discretisation applied in the simulation. In turn, the feasible time step in a concrete situation depends on, apart from the inherent performance properties of the computational scheme, the dynamics of the flows in the simulated network. It is therefore desirable to optimise the algorithm so that in conditions of variable flow dynamics, which occur during the simulated interval, the total computational effort is minimised, while preserving stable and accurate computations.

It is not possible to give a single general rule for the selection of Δt and Δx covering all possible situations.

It should be noted that the 1D engine assumes a linear variation of all the variables between each time step and grid point. Hence one criterion for Δt and Δx is that they should be small enough to resolve non-linear variations in time and space, respectively. For example, simulation of tidal variations requires time steps in the order of 10-30 minutes in order to fully describe the tidal cycle in time, while fast flows through small pipes may require a time step in the order of 10 seconds. Rapidly changing river geometry requires space steps small enough to describe the topography accurately.

In order to obtain a stable and accurate solution to the finite difference scheme the following conditions have to be fulfilled:

- the topographic resolution must be sufficiently fine that non-linearities in water levels and discharges are adequately resolved. The maximum allowable value for Δx should be selected on this basis
- the time step, Δt , should be fine enough to provide an accurate representation of a wave. For example, the maximum time step for a tidal simulation is generally around 30 minutes
- in general, if structures are active then a smaller time step is required
- the Courant condition:

$$C_r = \frac{\Delta t(V + \sqrt{gy})}{\Delta x} \quad (4.32)$$

where V is flow velocity can be used as a guide for selecting the time step providing the above conditions are also satisfied. The Courant number expresses the number of grid points a wave, generated from a minor



disturbance, will move during one time step. Typically a value of C_r is of the order of 10 to 15, but much higher values have been used (up to 100)

- the velocity condition:

$$\frac{V\Delta t}{\Delta x} \leq 1 \text{ to } 2 \quad (4.33)$$

can sometimes impose a limitation on the time step in the case of rapidly varying cross sections. It requires that Δt and Δx are selected so that a water body is not transported more than one grid point per time step.

4.13 Adaptive Time Step Size

The computational efficiency of any discrete-time numerical simulation algorithm is highly dependent on the time step size applied in the simulations.

In turn, the feasible time step in a concrete situation depends on the inherent performance properties of the computational scheme and the dynamics of the flows in the simulated network. It is therefore desirable to optimise the algorithm so that in conditions of variable flow dynamics, the total computational effort is minimised, while preserving stable and accurate computations.

The 1D engine includes three modes of time step size control: Fixed, tabulated and adaptive.

Fixed time stepping is the traditionally used time stepping where a time step is specified as input and used throughout the simulation period.

In the tabulated time step mode, time step sizes are given as a time series. Tabulated time stepping is especially useful when studying events that occur at a certain time that is known in advance of the simulation. For instance a dambreak known to occur at a certain date and time or a massive inflow occurring in a certain month every year due to a rainy season, etc.

The adaptive time stepping is used for modelling scenarios where the preferred time step is not known in advance. The adaptive time step may be used for obtaining a more detailed modelling of certain critical parts of a simulation, typically parts where large changes appear or it may be used for preventing calculations to blow up due to numerical instabilities.

Adaptive time stepping adjusts the time step size to be between a minimum and maximum time step size, both user specified. A number of checks on the boundary values and the solution are used during the simulation to adjust the time step size. All checks are optional.

Adaptive time stepping can be applied to Dynamic and Diffusive flow descriptions, but it cannot be used with the Kinematic flow description.



The remainder of this section presents details of how adaptive time stepping determines the time step size.

4.13.1 Adaptive step size methodology

In the 1D engine adapts the time step size in a two step process:

First, before every time step, the preferred time step is calculated based on boundary checks and the solution from the last time step. For every solution check, a factor is calculated that defines how much the time step can be increased in order for the check still to be valid. If the solution evaluates to only half of the check limits, the time step size can be doubled (the factor will be 2).

The smallest of the factors from all solution checks is used to calculate the preferred time step. The new time step size is the factor times the time step size of the last time step times a buffer factor. The buffer factor is between 0.95 and 0.99.

Second, the time step is performed. If one or more of the solution checks are not fulfilled, then the time step is rejected and the time step decreased (at least by a constant factor), and the time step is performed again with the new time step.



This methodology is different from the one employed in MIKE+. Chiefly, in MIKE+, if a check fails, then the actual solution is a linear interpolation of the prior solution and the new solution for which the check failed. The methodology in the 1D engine is superior to the MIKE+ methodology since the calculated solution is not based on linearly interpolating a result which failed the checks, and therefore the net accuracy is higher. The result is that the 1D engine performs fewer time steps than MIKE+ while retaining the same or higher accuracy.



This methodology is different from the one employed in MIKE 11. Chiefly, in MIKE 11, the time step size is increased by a constant factor before each time step. If a check fails, then the solution is discarded and the time step is re-calculated. The methodology in the 1D engine is superior to the MIKE 11 methodology since substantially fewer time steps are re-calculated.

4.13.2 Boundary value check

The check on the boundaries helps avoiding input details to be neglected due to application of too large a time step. The boundary check limits the acceptable relative difference between the boundary value obtained by linear interpolation between two solution times, t and $t+\Delta t$, and the actual boundary value given in the boundary time series. The difference is calculated at three points in the t to $t+\Delta t$ interval. If the maximum of these three values divided by the interpolated value is larger than acceptable relative difference, then the time step is too large. Figure 4.16 illustrates this principle.

Since this is a check on the relative value of the boundary, it is only active if the boundary value at $t+\Delta t$ is larger than a specified minimum value.

This sampling criteria used when checking boundaries is very general and is applied to all types of boundaries.

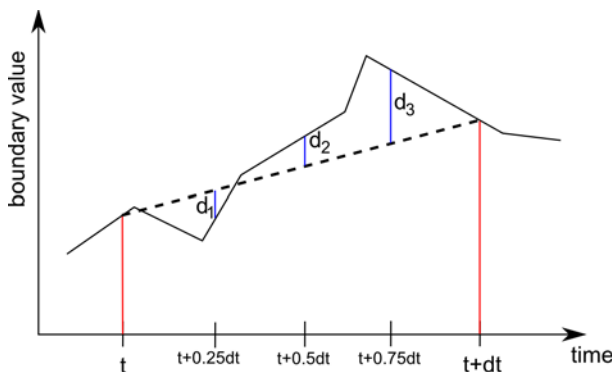

Figure 4.16 The black line is the actual boundary values and the dashed line is the linearly interpolated boundary used in the simulation. The maximum of the differences d_1 , d_2 , and d_3 relative to the boundary value is limited by the boundary value check



In MIKE+, the maximum allowed relative variation is $Q_{acceptLimitRel}$, and the specified minimum value for the check to be active is $Q_{lowLimitM3s}$, both from the *dhiapp.ini* file.

The default value of $Q_{acceptLimitRel}$ is 0.1 and $Q_{lowLimitM3s}$ 0.01.



In MIKE 11, the maximum allowed relative variation is $resid(BC)/BC$, and the specified minimum value for the check to be active is BC , both from the *Time Step Settings dialog window*.

4.13.3 Solution check: Discharge variation in grid points

Two check are performed on the discharge in q -grid points. First, the variation in discharge must be below a specified value:

$$|\Delta Q| < val_q \quad (4.34)$$

Secondly, the relative variation in discharge must be below a specified value:

$$\left| \frac{\Delta Q}{Q} \right| < val_{qRel} \quad \text{for} \quad |Q| < limit$$



This check is not available in MIKE+



In MIKE 11, val_q is $delQ$, val_{qRel} is $delQ/Q$, and $limit$ is Q , all from the *Time Step Settings dialog window*.

4.13.4 Solution check: Water level variation in grid points

Two checks are performed on the water level in h -grid points. First, the variation in water level must be below a specified value:

$$|\Delta h| < val_h \quad (4.35)$$

Secondly, the relative variation in water level must be below a specified value:

$$\left| \frac{\Delta h}{d} \right| < val_{hRel} \quad \text{for} \quad |d| > limit$$

where d is the water depth.



In MIKE+, the variation in water level check is not performed. The relative water level check is performed, but d is the height of the cross section at that h -grid point, and the limit is applied to the relative depth. In addition, if the relative change in water level is below $limit$, then val_{hRel} and $limit$ are adjusted down as a function of relative depth, with a minimum value of 0.02.

Both val_{hRel} and $limit$ are *WaterLevDiffMaxRel* from the *dhiapp.ini* file

The default value of *WaterLevDiffMaxRel* is 0.3.



In MIKE 11, val_h is $delh$, val_{hRel} is $delh/h$, and $limit$ is h , all from the *Time Step Settings dialog window*.

4.13.5 Solution check: Water level variation in nodes

The check on water levels in nodes is actually a check on all connections into the nodes. The check is active only if water flows from the connecting reach into the node. In addition, the following two conditions must be true. First, the water level in the grid point closest to the node at time $n+1$ plus 0.05 must be smaller than the water level in the node at time $n+1$ (time $n+1$ refers to the most recent values, while time n are the values of the previous time step). In an equation it can be written as:

$$h_{np1, gp} + 0,05 < h_{np1}$$

Second, the water level in the grid point at time n must be larger than the water level in the node:



$$h_{n, gp} > h_n,$$

where h is water level, n and $n+1$ refer to the time step, and gp is for grid point.

If these three conditions are all true, and

$$h_{np1, gp} - h_{n, gp} + 0,05 < h_{np1} - h_n$$

then the time step is adjusted with a factor of

$$\frac{h_{np1, gp} - h_{n, gp} + 0,05}{h_{np1} - h_n}$$



This check is not available in MIKE 11.

4.13.6 Solution check: Courant value

There are two types of checks on the Courant number. An “HD” Courant check:

$$|Cr_{HD}| = \frac{v + \sqrt{gD}|\Delta t|}{\Delta x} < val_{HD} \quad (4.36)$$

and an “AD” Courant check:

$$|Cr_{AD}| = \frac{v|\Delta t|}{\Delta x} < val_{AD}$$

where v is the flow velocity, Δx is the grid spacing, g is acceleration due to gravity, and D is flow area divided by flow width.



In MIKE+, only the “AD” Courant check is performed. val_{AD} is *MaxCourant* from the *dhiapp.ini* file.

The default value of *MaxCourant* is 20.



In MIKE 11, val_{HD} is *Courant(HD)*, val_{AD} is *Courant(AD)*, both from the *Time Step Settings* dialog window.



4.13.7 Solution check: Pumps

Pumps can influence the time step size, but only of the flow calculation through the pump is *explicit*. Implicit pumps do not influence the time step size.

If the pump is either acceleration or decelerating, then the time step size is set to

$$\Delta t = \Delta t_{min} + f_{pump}(\Delta t_{max} - \Delta t_{min})$$

where Δt_{min} and Δt_{max} are the lower and upper limits on the time step size, respectively, and f_{pump} is a user specified constant.

If the pump is *not* either acceleration or decelerating, then the time step is adjust if

$$|q_{np1} - q_n| > \frac{0,05 q_{np1} \Delta t_{min}}{\Delta t_n - \Delta t_{min}}$$

where Δt_n is the previous time step. If this condition is true, then the time step is set to

$$\Delta t = \Delta t_{min} \left(1,0 + \frac{0,05 q_{np1}}{|q_{np1} - q_n|} \right).$$



In MIKE+, f_{pump} is *PumpAccDecVarDtRel* from the *dhiapp.ini* file.

The default value of *PumpAccDecVarDtRel* is 0.



The check is not available in MIKE 11

4.13.8 Solution check: Cross section parameters

Variation in the cross section parameters A , $R^{2/3}$ and B , where A is the cross section area, R is the hydraulic radius and B the width of water surface can influence the time step size. If the check is active then the cross sections is all h -grid points are checked.



These checks are active only if the relative water depth in the cross section is larger than a user specified limit.

The variation in the three cross section parameters is limited by:

$$\Delta X < f_{XS} \cdot \text{Max}(X) \quad (4.37)$$

where the variable X is one of the three cross section parameters and the meaning of $\text{Max}(X)$ is either the maximum possible value of that parameter, or the actual value (user configurable). f_{XS} is a user specified constant.

If the check is not true, then the time step size is adjusted by a factor of

$$\frac{\Delta X}{f_{XS} \cdot \text{Max}(X)}$$



In MIKE+, the limit value on the relative depth for whether the check is active is *CrossLowDepthLimit* from the *dhiapp.ini* file. The factor f_{XS} is *MaxVarCrossConstant* from the same file. Whether $\text{Max}(X)$ refers to the maximum value or the actual value of the cross section parameter is controlled by *Crosscheck* from the *dhiapp.ini* file. If *Crosscheck* is 1, then the maximum value is used. If *Crosscheck* is 2, then the actual value is used. If *Crosscheck* is 0 then the checks are disabled.

The default value of *MaxVarCrossConstant* is 0.03, of *Crosscheck* it is 1 and of *CrossLowDepthLimit* it is 0.04.



The check is not available in MIKE 11



5 Boundaries

A boundary defines the interaction between a model and its external surroundings.

There are two conceptually different types of boundaries: Open boundary conditions and additional boundary sources.

An *open boundary* condition describes the interaction of a model boundary with its surrounding. An open boundary can be identified by a volume free node with only one connecting reach. An example is the end or beginning of a river, or an outlet from a sewer. Such a node must be provided with an open boundary condition in order to solve the flow equations.

Additional boundary sources are used to interact with a specified part of the network. An example is inflow from a factory to the sewer. Additional boundaries are optional, i.e. they can be added and removed from the model, and the model will still be valid.

Additional boundary sources come in several variations:

- Point source boundaries
- Distributed source boundaries
- Global source boundaries.

They differ in the way they connect to the model.

A boundary provides a value during the time when it is active. Its value can change over time. For most types of boundaries the following time variations are supported

- Constant value.
- Time variable, defined in a time series file (dfs0 or similar).
- Periodic daily variation.

These “value providers” for a boundary are called boundary items. One boundary can have several boundary items, that are active simultaneously or at different times. See Section 5.3 for details.

An open boundary condition must be defined over the entire simulation period.



Most boundary conditions specified in MIKE+ are additional boundary conditions or based on a structure like a weir or similar. The only open boundary condition in MIKE+ is the outlet/water level boundary. Usually in MIKE+ a network end is a reach ending in a manhole, which has an additional boundary source attached. ■



5.1 Open Boundary Conditions

An open boundary can be identified by a volume free node with only one connecting reach.

Such a node must have a boundary conditions set before the flow equations can be solved.

The following sections describe each of the possible open boundary conditions that are supported.

5.1.1 Closed boundary

A closed boundary specifies that no water flows in or out of the model through this boundary, and corresponds to setting a wall at the end of the reach, hence it is also called a wall boundary.

5.1.2 Inflow boundary and lateral inflow

An inflow boundary specifies an amount of water that flows into or out of the model. The amount of water is specified as a discharge. The sign of the boundary matches the discharge sign in the reach, i.e. inflow must be specified positive in the upstream end and negative in the downstream end, and opposite for outflow.

The inflow boundary sets up the equations as if there was another reach connected at the boundary that had a flow through the reach matching the specified discharge.

As an alternative, you could specify a closed boundary condition and a lateral inflow at the boundary. That would discharge the same amount of water at the same place into the model. The difference between the two is that for an inflow boundary the water enters the model with momentum, while for the lateral inflow the water enters the model without momentum. When the water does not have momentum, it needs to be accelerated before it moves, giving higher water levels around the closed boundary with lateral inflow than the inflow boundary condition would give.

An inflow boundary can be specified with or without AD components. If specified without, a zero value is assumed for all AD components.

An inflow boundary with constant zero inflow corresponds to a closed boundary, see Section 5.1.1.

5.1.3 Water level boundary - the outlet

A water level boundary specifies a water level at the boundary.



Water that runs in/out of the model does so with momentum, as is the case with the inflow boundary.

If water flows out of the model, the model applies a free outflow condition, if the free outflow water level is higher than the water level from the boundary. The condition looks like:

$$H = \max(H_{out}, H_b + \min(y_n, y_c)) \quad (5.1)$$

where

H_{out} : water level from boundary condition
 y_c : critical depth for the current flow velocity
 y_n : natural depth for the current flow velocity

Otherwise, the model applies the specified water level at the boundary, with the corresponding backwater effect and a possibility for inflow.

The free outflow behaviour can be disabled in the HD parameters

A water level boundary can be specified with or without AD components. If specified without, a zero value is assumed for all AD components.



In MIKE 11, currently the use of the natural/critical free outflow condition is disabled. ■

5.1.4 QH boundary

A QH boundary is a type of inflow boundary, where the inflow Q is found as a function of the current water level H.

The relation between Q and H is specified in a QH table. For every water level H, the corresponding Q value is linearly interpolated in the QH table and used as the inflow boundary value. A QH boundary can specify inflow as well as outflow for different water levels.

When looking up the value of Q in the QH table, the value of H is only known at the previous time step. To obtain a more accurate value of the discharge, a Taylor expansion is used:

$$q^{n+1} = Q(H^n) + \left. \frac{\partial Q}{\partial H} \right|^n \cdot \frac{H^{n+1} - H^n}{\Delta t} \quad (5.2)$$

where $Q(H^n)$ and $\partial Q / \partial H$ are calculated from the QH table for the previous water level H^n and used when solving the implicit equation system.

A QH boundary can be specified with or without AD components. If specified without, a zero value is assumed for all AD components.



5.1.5 Which boundary condition?

The choice of the boundary condition depends on the physical situation being simulated and the available data.

Typical upstream boundaries could be:

- Discharge or water level of a reservoir.
- A discharge hydrograph of a specific event.

Typical downstream boundaries could be:

- Water level, e.g. in a large receiving water body.
- Tidal cycle water level.
- A QH rating curve, e.g. from a gauging station.

5.2 Additional Boundary Sources

Additional boundary source contributions enter the model as a source or forcing term, as either the q_{in} in the mass balance equation, Equation (4.1a), or f in the momentum conservation equation, Equation (4.1b).

A source in Equation (4.1a), the mass balance equation, will add water into the model, while a forcing in the momentum equation will accelerate the water in the positive flow direction.

The different additional boundary sources differ in the way they connect to the model and how their contribution is distributed over a part of the network:

- Point source boundaries
- Distributed source boundaries
- Global source boundaries

Each type will be described individually in the coming sections.

Regarding negative inflows (extraction of water from the model): these should be carefully constructed since extraction of more volume than the model has available will end up with mass errors in the computations, and a model that may be unstable and fail to run to completion.

5.2.1 Point source boundaries

A point source boundary adds a source contribution to one or more points in the network. It can add contributions to nodes and reach locations.

Each point has an associated scale factor. The boundary value is multiplied with the scale factor before it is applied to the point.



The scale factor can be used by sources that have a default-normed contribution, for example per person, to scale it with the number of persons relating to a given point. It can also be used to distribute one source contribution over a number of points.

Currently supported point source boundaries:

- Inflow boundary
- Node infiltration boundary



Node infiltration is a MIKE+ boundary where the inflow to a node is proportional to the *maximum surface area* of the node for all water levels lower than the current water level. For manholes, node infiltration is independent of the water level (surface area is constant) while it can vary appreciably from basins. ■

5.2.2 Distributed source boundaries

A distributed source boundary adds a source contribution to one or more reach sections, and sometimes entire reaches in the network. It specifies either a reach section (ID, start and end chainage), or an entire reach.

A distributed boundary can distribute its contribution in three different ways. The *distribution types* are called

- Total value
- Value per length
- Value per area.

“*Total value*” distributes the value of the source so that the sum of the amount for all reach sections is equal to the source value. Each reach section receives a contribution matching the relative length of the section compared to the total length of all sections in the source.

“*Value per length*” assumes that the source contribution is a contribution per length, and the value of the source is multiplied by the length of the reach section.

“*Value per area*” assumes that the source contribution is a contribution per area unit, and the value of the source is multiplied by the surface area of the reach section. This type is only applicable for open reaches.

Currently supported distributed source boundaries:

- Inflow
- Rainfall runoff inflow. It has always the “Total Value” distribution type.
- Wind field.



5.2.3 Global source boundaries

A global source boundary is a boundary that can be applied over the entire network.

A global source boundary has a number of boundary items, each being geo-located and having an (x,y) coordinate.

If only one boundary item is specified, it is valid for the entire network, and no (x,y) point needs to be specified for the item.

If specifying more than one boundary item, each must have a unique (x,y) coordinate. When applying the global source to a specified point, the boundary item that is closest to the point is used.

On top of the global boundary items, it is possible to specify a number of distributed overrides, i.e. distributed source boundaries that override the global value.

Currently supported global source boundaries

- Rainfall
- Evaporation
- Wind field
- Ground Water Leakage



Ground Water Leakage is a MIKE 11 boundary where the discharge out of all h-grid points is a per length contribution which is proportional to 1) a constant specified in HD parameter file, 2) the water depth above ground water head, and 3) the wet perimeter of the cross section.

The ground water head can be specified as a global boundary in the MIKE 11 user interface. If there is no ground water head boundary, then the regular water depth is used.

$$Q_{Leakage} = C_L \cdot P \cdot D \cdot \Delta x \quad (5.3)$$

where:

CL : Leakage coefficient (user defined)

P :Wet perimeter

D: Water depth above groundwater head

Δx : grid spacing

NOTE: The wet perimeter is calculated as the flow area divided by hydraulic radius. Thus, it is assumed that the flow area and the hydraulic radius and the



flow area in the cross sections are the actual flow area and the proper hydraulic radius. This is not the case if Relative Resistance and/or Resistance Radius is used in the cross sections. In these cases care is needed when defining ground water leakage coefficients. ■

5.3 Boundary Items

A boundary item is a “value provider” for a boundary. Every boundary has at least one boundary item. Typical boundary items that are supported by most boundaries are:

- Constant value boundary item
- Time varying boundary item, defined in time series (dfs0 or similar)
- Daily periodic pattern

A boundary can have several boundary items.

Some boundary types allow for only one item to be active at any time, while other boundary types allow for several items to be active at the same time. For example, an inflow boundary can have several active items, which will combine their contributions, while a water level boundary only allows for one active item at a time.

Each item can have a defined application time, which is a time interval where the item is active.

5.3.1 Application time

The application time defines the start time and the end time when the boundary item is active.

The use of the application time is by default disabled, and can be enabled for each boundary item individually.

Some boundary items have a pre-defined application time. For example, a time series has a pre-defined application time equal to the interval over which data is available. The application time for such boundary items can only be set to limit the application time, not extend it beyond the pre-defined application time.

When application time is disabled, the item is applicable for the entire simulation period or within the pre-defined application time of the item.



5.3.2 Soft start

Soft start is used to modify the value of a boundary item such that it smoothly changes from a user-defined value to the value of the boundary item over a period of time.

To define a soft start, you must specify:

- Type of soft start
- Soft start value
- Soft start duration

The type of soft start can be one of:

- None; no soft start
- Linear; a linear weighting of the soft start value and the actual boundary value within the soft start period
- Sinusoidal; a smooth, non-linear weighting of the soft start value and the actual boundary value within the soft start period. The weighting is based on a sinusoidal function.

The start time of the soft start is the boundary item application start time. If no start time is defined, then it is the start of the simulation, or the predefined start time of the item.

Soft start is mostly used for stability reasons. For example: if the initial conditions at a water level boundary define the water level to 5 metres, and the water level boundary condition defines a constant water level of 10 m, then in the first time step the water is raised from 5 to 10 m, thus creating an unnatural wave through the model, and in the worst case destabilising the model and causing it to fail. In such a case it is wise to set soft start parameters that gently increase the value from 5 to 10 metres over the first 10 minutes of the simulation.

5.3.3 Resolution of a time varying boundary item

For a time-varying boundary item, the times defined in the item do not usually match the times in the simulation. To ensure that values match the time in the simulation, linear interpolation is performed.

If the temporal resolution of a boundary item is not very good, for example if it describes only the extremes of a tidal cycle, some preprocessing of the data may be necessary in order to describe a more correct and smoother variation of the tidal cycle.



6 Structures

Structures (also referred to as *functions*) calculate the discharge between two h -grid points in a reach. Structures replace a q -grid point in the computational grid. The discharge through a structure is calculated from the water levels upstream and downstream, and the internal state of the structure.

The MIKE 1D engine includes a wide range of structures that taken together permit great flexibility in both the degree of user-intervention in flow patterns and the level of complexity of the structure.



MIKE 11 structures require a user-defined cross section to be present within “Maximum dx” (River Network Editor / Branches) from the structure. ■

6.1 General Flow Conditions

In this section, we discuss general aspects that apply to all structures.

6.1.1 Zero flow

In general, if the water level on both sides of a structure are below the invert level of the structure, or the water levels upstream and downstream of the structure are equal, then the flow over the structure will be zero. Many of the 1D structures can have an associated valve. If the valve is closed, then the flow over the structure will also be zero.

6.1.2 Drowned flow

If the flow on either side of the structure is in the same state as over the structure itself, i.e. both subcritical or both supercritical, then the flow across the structure will be *drowned flow*. For example, the discharge over a simple broad crested weir with constant width b , the drowned flow is generally given by:

$$Q = \mu b (h_1 - Z_c) (h_1 - h_2)^{1/2} \quad (6.1)$$

where μ is the weir discharge coefficient, h_1 and h_2 the upstream and downstream water levels respective, and Z_c the weir crest elevation.

6.1.3 Free overflow

Free overflow occurs when the water levels at both sides of a structure are such that the system seeks to deliver the maximum discharge for a given energy head at the upstream side of the structure. This leads to critical flow at (or very near to) the most narrow section (called the *control section*).

In the case of free overflow, the discharge is independent of the downstream water level, i.e. upstream controlled. In principle the discharge can be computed from the condition that the flow is critical at the control section for the given upstream energy head.

Several factors influence the actual free overflow discharge through a structure:

- the section where critical flow occurs is often located downstream of the most narrow section, especially for well designed spillways
- the velocity is not distributed uniformly over the cross section, thus the critical discharge is reduced
- the water level is not constant over the cross section, especially in the case of an irregular section



In MIKE 11, the critical discharge is corrected with a coefficient, α_c , (in the Headloss Factors box) in an attempt to account for the three factors above. This gives the real discharge:

$$Q = \alpha_c Q_c \quad (6.2)$$

where Q_c is the critical discharge. Free overflow is modelled on the basis of a relationship between the discharge and the upstream water level. This relationship is generated automatically by MIKE 11 for Broad Crested Weirs and Culverts *QH* Relations Calculated. In the case of user-defined structures (i.e. Special Weirs and Culverts) the specified *QH* relation is applied. For the remaining structure types, the critical discharge is computed during the simulation. ■

6.1.4 Contraction and expansion losses

Broad Crested Weir, Special Weir and Culverts use an energy headloss formulation. These headlosses are functions of the coefficients ζ_{in} and ζ_{out} and the ratios of the structure area and the cross section areas in the immediately adjacent reach.

IMPORTANT! During pre-processing of *QH*-relation in Broad Crested Weirs, the ratio of structure area and river cross section area is used to compute the *QH*-relation. This requires that the cross section area of the reach is always greater than that at the structure. An error message will appear in case the weir area is larger than the up- or downstream cross section area, as it is not possible to establish the *QH*-relation for free overflow. To correct this, check cross sections and weir geometry. The values of ζ_{in} and ζ_{out} are typically 0.5 and 1.0, respectively.



In MIKE 11, the coefficients ζ_{in} and ζ_{out} are specified in the Headloss Factors box. ■



See Appendix A.2.4 for details of how energy headlosses are calculated for Broad Crested Weir, Special Weir and Culverts.

6.1.5 Composite structures

Several structures can be defined on the same q -grid point. The total discharge across the combined structures (also called a *composite structure*) is calculated by iteration until a stable flow is achieved.

During the iteration, the energy headloss of the structures is modified; thus, only structures that apply an energy description are modified in the iteration process. These include Special Weirs, Culverts and Broad Crested Weirs. If none of these structures are present in a composite structure, then no iterations are performed.

6.1.6 External structures with reservoir



MIKE 11 has the option of specifying a structure as **external**, meaning that downstream, the structure is not connected to the network. If water flows across the structure, then it runs out of the network.

If a **reservoir** is attached to the external structure, then water is collected in a reservoir downstream of the structure. The downstream water level is given by the water level in the reservoir which is determined by the reservoir geometry. Based on the upstream and downstream water levels the structure can allow the water to run out of the reservoir and back into the network.

The reservoir geometry is specified by a table which can either contain the reservoir surface area as a function of water level or the reservoir volume as a function of water level. ■



External structures with a reservoir are equivalent to a structure with a downstream basin which is only connected to the structure, where the basin has the exact same geometry as the reservoir.

6.2 Overflow Formula (MIKE+ Broad Crested Weir)

The standard formulations for Overflow Formula are established automatically on the basis of the weir geometry and the user specified headloss and calibration coefficients. Different algorithms are used for drowned (or submerged) flow and free overflow, with an automatic switching between the two.

Both algorithms assume a hydrostatic pressure distribution on the weir crests (constant water depth on the crest).



In MIKE+, the standard weir type is called a Broad Crested Weir. In the 1D engine, this standard MIKE+ structure is called Overflow Formula. ■

6.2.1 Free overflow formulation

The MIKE 1D engine provides two different methods for the computation of the free overflow:

- Flow computation based on the energy loss coefficient and weir orientation.
- Flow computation based on a standard rectangular overflow weir formula with user-specified discharge coefficient.

Energy loss coefficient formulation

In case of a free overflow, the water depth above the weir crest will be equal to the critical water depth. The energy loss occurs depends on the structural configuration. The overflow situation is shown in Figure 6.1

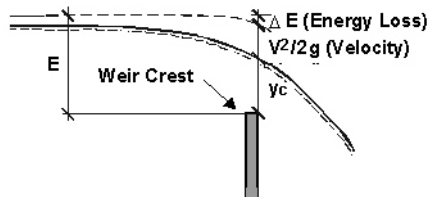

Figure 6.1 Free overflow

In the critical flow cross section, the Froude number Fr is equal to 1, and the critical flow condition can be written as:

$$Fr = \frac{v}{\sqrt{gy_c}} = 1 \quad (6.3)$$

where:

$$\begin{aligned} v &= \text{mean flow velocity, [ms}^{-1}\text{]} \\ y_c &= \text{critical depth, [m]} \\ g &= 9.81 \text{ [ms}^{-2}\text{]} \end{aligned}$$

Conservation of energy between the upstream and critical cross section yields:

$$E = y_c + \frac{v^2}{2g} + \Delta E \quad (6.4)$$



with:

$$\Delta E = K_c \cdot \frac{V^2}{2g} \quad (6.5)$$

where:

- E = energy level at the cross section just upstream the structure, [m]
- ΔE = Entrance energy loss, [m]
- K_c = Energy loss coefficient

Based on the energy conservation and critical flow principles, discharge over a plane overflow having a structure width B [m], is calculated for a weir orthogonal to the flow axis (90°), as:

$$Q_{weir} = B \cdot \sqrt{g} \cdot \left(\frac{2}{2 + K_c} \cdot H \right)^{\frac{3}{2}} \quad (6.6)$$

and for a 'side' overflow weir (0°):

$$Q_{weir} = B \cdot \sqrt{g} \cdot \left(\frac{2}{3 + K_c} \cdot H \right)^{\frac{3}{2}} \quad (6.7)$$

where:

- H = water depth above the weir crest level, [m]
- K_c = energy loss coefficient associated with the outlet head-loss, specified for the weir node.

This corresponds to the standard overflow formula for a rectangular notch:

$$Q_{weir} = \frac{2}{3} \cdot C_d \cdot B \cdot \sqrt{2g} \cdot (H)^{3/2} \quad (6.8)$$

where C_d is a discharge coefficient, expressed for an orthogonal weir as:

$$C_d = \frac{3}{(2 + K_c)^{3/2}} \quad (6.9)$$

and for a 'side' overflow weir:

$$C_d = \frac{3}{(3 + K_c)^{3/2}} \quad (6.10)$$

E.g., this method if used with $K_c = 0.5$ (sharp-edged outlet), is equivalent to a standard weir formula with $C_d = 0.7589$ and $C_d = 0.4582$ for orthogonal and for side weir, respectively.

The side overflow yields a smaller discharge for the same overflow level, because in this case the kinetic energy of the approaching flow is excluded from the computations.

User-specified discharge coefficient

If the method with default energy loss coefficient is not applicable for a particular weir, the standard overflow formula Equation (6.8) is applied with a user-specified “level” discharge coefficient $C_H = 2/3C_d$, which gives:

$$Q_{weir} = C_H \cdot B \cdot \sqrt{2g} \cdot (H)^{\frac{3}{2}} \quad (6.11)$$

This implies that the headloss coefficient specified for the weir node and the weir orientation are ignored in the weir computation.

6.2.2 Submerged overflow

Discharge across a submerged weir is calculated using the same critical depth formulation as above for a free overflow, except that the head driving the flow is expressed as the difference between the upstream and downstream water surface elevations. See figure Figure 6.2.

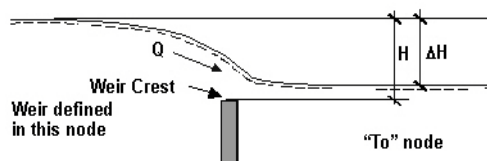

Figure 6.2 Submerged overflow

The submerged weir flow is then (with user-specified “level” discharge coefficient) approximated as:

$$Q_{weir} = C_H \cdot B \cdot \sqrt{2g} \cdot \frac{H}{\Delta H} (\Delta H)^{\frac{3}{2}} \quad (6.12)$$

or with energy loss coefficient, for orthogonal overflow weir:

$$Q_{weir} = B \cdot \sqrt{g} \cdot \left(\frac{2}{2 + K_c} \cdot \Delta H \right)^{\frac{3}{2}} \cdot \frac{H}{\Delta H} \quad (6.13)$$



and for a 'side' overflow weir (0°):

$$Q_{weir} = B \cdot \sqrt{g} \cdot \left(\frac{2}{3 + K_c} \cdot \Delta H \right)^{\frac{3}{2}} \cdot \frac{H}{\Delta H} \quad (6.14)$$

6.3 QH Structure (Special Weir)

A QH structure uses a user-defined *QH* relation, that consists of at least two tabulated values for water level above the weir crest, H [m], and corresponding discharge, Q [m³/s]. Intermediate values are linearly interpolated.

QH structures are used to model a structure whenever the standard formulation for a broad crested weir or a culvert is not sufficiently flexible.

The *QH* relation has to fulfil certain conditions:

- the first H -value has to be the overflow elevation (weir crest);
- all Q -values must be positive, or all Q -values must be negative, i.e. water must flow either downstream or upstream for all H -values;
- the H -values have to be given in a monotonously increasing order, or decreasing if Q -values are negative;
- the largest H -value given in the table shall not be less than the largest H -value to be computed. The model does not extrapolate beyond the tabulated values.

Note that if all Q -values are negative, then the control water level is taken from the geometric downstream (meaning that the control water level is always where the water is coming from).

6.3.1 Special weirs

Special weirs are QH structures, but with some added functionality:

1. Two QH relationships can be specified, one for positive flow and one for negative flow. Both relationships use the water level at the **upstream** (geometric, not flow determined!) h-grid point.
2. The QH relationships are used for free overflow. For submerged flow, a steady state energy equation is used.



6.3.2 Tabulated structure

Similarly to a QH Structure, the discharge through a Tabulated Structure is calculated based on values in a table. However, for the Tabulated Structure, the table is two dimensional. The values in the table can be one of three different types:

1. Discharge as a function of up- and downstream water levels.
2. Upstream water level as a function of discharge and downstream water level.
3. Downstream water level as a function of discharge and upstream water level.

The actual discharge through the Tabulated Structure is found by appropriate interpolation in the tabulated values.

6.4 Pump

A pumps generates a discharge based on one of

1. A constant discharge
2. QH table: A H [m] and Q_{pump} [m^3/s] table where the discharge is a function of the upstream water level.
3. $Q\Delta H$ table: A ΔH [m] and Q_{pump} [m^3/s] table where the discharge is a function of the water level difference downstream and upstream. A positive ΔH means that the downstream water level is larger than the upstream water level

For both QH and $Q\Delta H$ tables, discharge values must be positive or zero and monotonously increasing, or negative or zero and monotonously decreasing.

Discharge values for water levels not present in the table are linearly interpolated. The largest value in the QH table must be larger than the maximum water level encountered during the simulation, or the simulation will fail (no extrapolation is performed).

6.4.1 Real time control

The discharge of a pump can be controlled externally. If the pump is controlled, then a QH or $Q\Delta H$ table act as maximum allowed discharge. A minimum allowed discharge QH or $Q\Delta H$ table can also be specified.



Wet well setpoint



In MU, a so called *wet well setpoint* value can be specified for a pump. If this value is specified, then a PID control is created which works to maintain the water level in the upstream node to the specified value. The PID control has the following default parameter set: Integration period is 300 seconds, derivation period is 0.8 seconds and all time step weight factors are 1.0.

6.4.2 Start and stop levels

Pumps are active only for certain water levels, controlled by the start and stop water levels. Initially, the pump is in an inactive state. If the upstream water level rises above the start level, then the pump becomes active.

The pump will remain active until the upstream water level falls below the stop level. When the upstream water level falls below the stop level then the pump becomes inactive.

6.4.3 Maximum pump discharge

It is only possible to pump water if there is enough water upstream from the pump. The pump can limit the discharge across the pump in response to the amount of water available for pumping.

The discharge across the pump can be limited in one of two different ways:

1. In a specific time step, the discharge across the pump is set to the maximum possible discharge. The maximum possible discharge is calculated in the upstream (flow direction) h -grid point such that after the time step, the volume of water in the h -grid point is $0.3 \cdot \text{DELH}$, where DELH is a h -grid point specific parameter which is used to limit discharge at low water level, see D.1 MIKE 11 Default Values (p. 333). For side structures, the available volume is the estimated volume in the node plus the estimated volume in the h -grid points connected to the node
2. If the water depth in the upstream (flow direction) h -grid point approaches zero, then the discharge is suppressed by a factor which approaches zero as the water depth approaches zero. This method is not used in side structures.

6.4.4 Start-up and shut-down times

Pumps can be set to ramp up pumping linearly over a specified time. If the start-up time is set to 10 minutes, then it will take the pump 10 minutes to reach the target pump capacity. This also applies if the target pump capacity changes over time: A pump with a start-up time of 10 minutes will have reached 50% of the target pump capacity after 5 minutes, even if the target



capacity at 5 minutes into pumping is different from the target capacity when the pump was activated.

For the shut-down time, the pump ramps down the discharge linearly from the discharge when the pump became inactive. For shut-down, the target discharge is always 0.

6.4.5 Outlet level

If an outlet level is defined for the pump, then the effective downstream water level (for $Q\Delta H$ tables) is the maximum of outlet level and downstream water level.

6.4.6 Negative discharge

Discharge values can be negative, meaning that water is pumped upstream (or into the network if the pump is at a boundary) instead of downstream (out of the network).

All discharge values for QH or $Q\Delta H$ pumps must be negative or zero, or positive or zero, i.e. the pump must either pump water downstream or upstream. Flow directions cannot be mixed in the same pump.

If the pump direction is upstream (negative discharge) then the control levels are downstream. Both the start/stop water levels and the discharge controlling water levels that are used in the QH ($Q\Delta H$) tables taken from downstream of the pump.

6.4.7 Time centring

As the pump performance can be quite significant even during start-up, it can be necessary to dampen the pump dynamics in order to sustain the numerical stability. The dampening is obtained by centring the pump rate backwards in time so that the pump performance does not instantaneously reach the full capacity but instead the pump discharge is gradually increased over several time steps.

Time centring of pumps is only conditionally active.

6.5 Valve

The discharge across a valve is given by equation (6.15)

$$Q = A \sqrt{\frac{2g\Delta H}{k}} \quad (6.15)$$



where

- g = the gravity constant
- k = the flow factor which depends on the opening of the valve.
- A = full open flow area of the valve
- ΔH = the energy drop over the valve.

An assumption for this equation is that the valve is located in a pipe which is running under pressure. However, should the system run under non-pressurised flow conditions the flow area A in equation (6.15) of the valve is reduced by a linear reduction for non-pressurised flow conditions:

$$A(d) = A \left(\frac{d}{d_f} \right) \quad (6.16)$$

where

- d = the depth of the flow depth
- d_f = the pressurised flow depth

This means that the velocity head upstream and downstream of the valve is equal and equation (6.15) can be rewritten to

$$Q = A \sqrt{\frac{2gh}{k}} \quad (6.17)$$

where

- h = the drop in pressure over the valve.

6.6 Orifice with Gate

The orifice is a very versatile structure. It describes flow through arbitrary shaped openings and handles transitions between different flow regimes.

A controlled gate can be included in the description. A gate is one or more polygons that cover the openings defined by the orifice polygons. The position and angles in three dimensions of the gate polygons can be controlled.

Both orifice and gate can be arbitrary polygons.

The numerical description is based on pre-computed discharge tables. The pre-computed tables contain the discharge through a rectangular, vertical slice of the orifice for a number of gate positions and upstream and downstream water levels. The total discharge through the orifice is determined by integration of the contribution from all effective openings, for the given gate position and the given upstream and downstream water level.

Vertical contraction is incorporated in the pre-computed discharge tables. The lateral contraction is computed during pre-processing and the discharge will be adjusted accordingly.

The equations used to set up the pre-computed tables are based on energy levels.

6.6.1 Orifice and gate polygons

Orifice and gate polygons can be of arbitrary shape. The only restriction is that intersecting lines are not allowed (see Figure 6.3).

Both the orifice and gate can include several openings, see

Rectangular and circular shapes are converted into polygons. Rectangular shapes are converted in the straight forward way, while circular shapes are converted into a polygon with 52 line segments that approximate a circle.

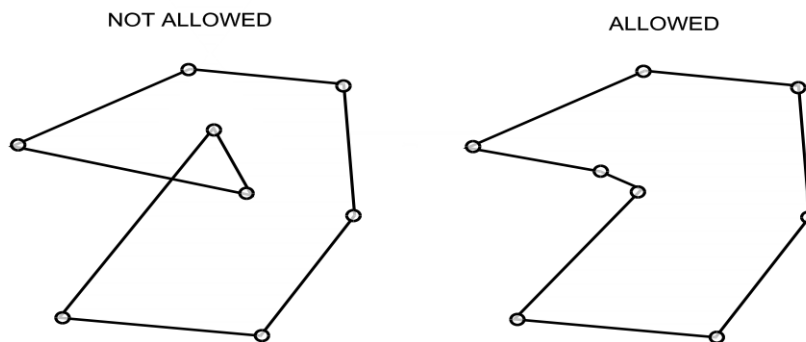

Figure 6.3 Intersection of polygon lines as shown on the left polygon is not allowed

6.6.2 Definition of verticals and slices

The orifice polygon is divided into 100 equally wide **verticals**. A vertical covers the polygon from top to bottom. The verticals are further sub-divided into horizontal **slices**, where the top and the bottom of the slice are where the centre of the vertical intersects the orifice or gate polygons. See Figure 6.4 for an illustration of how verticals and slices are defined.

The full discharge through the orifice is found by integrating the discharge through all open slices of the verticals.

The definition of verticals is analogous for orifice and gate polygons.

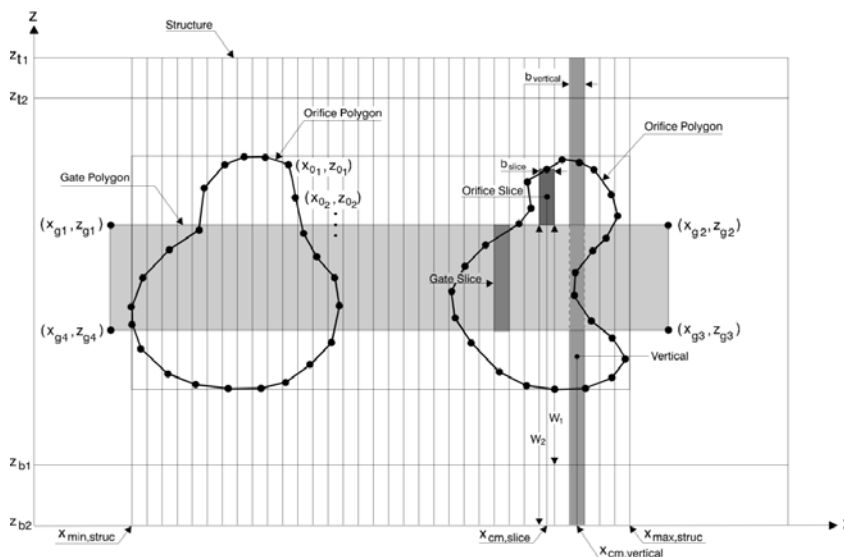

Figure 6.4 Definition of slices and verticals

It is important to note that the verticals cover the orifice without regard to local geometry. If, for instance, the orifice has a very wide top and a narrow bottom, and the water levels are such that the discharge is primarily in the narrow lower section of the orifice, then a situation can occur where the discharge is calculated based on only a few effective slices. In such situations, the orifice might not provide an accurate approximation of the flow dynamics.

6.6.3 Geometrical factors that determine the discharge through a slice

The discharge through a slice depends on: 1) the width and height of the slice, 2) the height of the crest level above the upstream cross section, and 3) the height of the crest level above the downstream cross section.

The width and height are simply determined from the geometry of the slice.

The height above the up- and downstream cross sections is more complex to determine, since they require the precise geometry of up- and downstream cross sections.

The bottom is considered to be horizontal from the upstream cross section to the orifice and from the orifice to the downstream cross section. The upstream weir crest is accordingly derived as the difference between the sill level for the orifice and the bottom level of the upstream cross section. Similar is the downstream weir crest given as the difference between the sill level of the orifice and the bottom level of the downstream cross section.

It is not enough to know the shape of the up- and downstream cross sections. The relative placement of the cross sections with respect to the orifice is also important.

By default, the cross section will be placed so that the centre of the cross section is aligned with the centre of the orifice. The placement of the cross sections can be controlled with the L_1 and L_2 parameters. See Figure 6.5.

If the cross sections block parts of the orifice openings, then a warning will be issued.

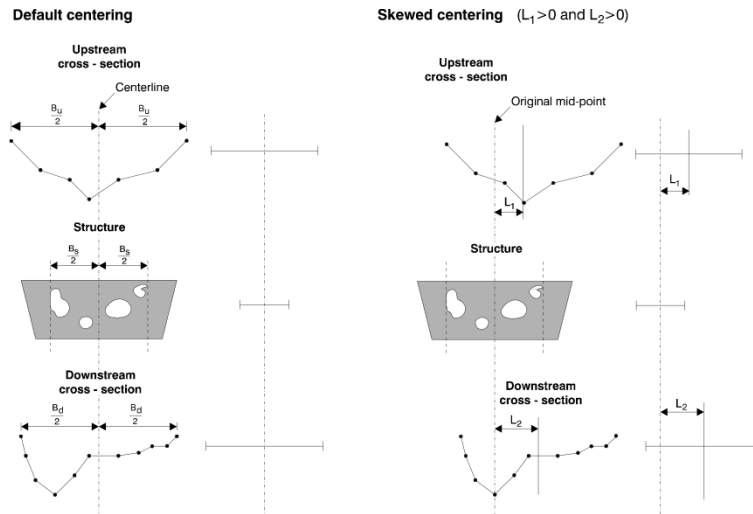

Figure 6.5 Centring of cross sections with respect to the orifice

It is important to realise that the orifice model, although it is detailed, still has short comings:

1. The effect of lateral flow contractions may not be represented correctly.
2. The effects of Coriolis energy coefficient may affect the discharge through the orifice, but is not included.

6.6.4 Calculating the discharge through a slice

There are four different type of flow regimes (supercritical flow excluded). The flow regimes are classified as: 1) free overflow, 2) submerged overflow, 3) free underflow and 4) submerged underflow. A definition sketch of the four types of flow regimes are shown in Figure 6.6.

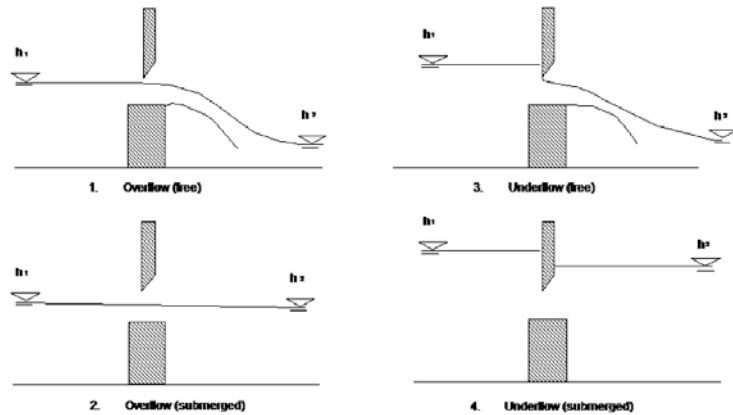

Figure 6.6 Classification of flow regimes

Depending on local conditions, several types of jets over the weir can be observed within these four types of flow regimes. The jet types can be classified as:

1. Ventilated jet
2. Pressurised jet
3. Lifted jet
4. Adhesive jet (with water filled head, with partly water filled and partly air filled head, and with air filled head)
5. Jet filled with rolling water underneath.

An illustration of these five types of jets are shown in Figure 6.7 for the free flow case.

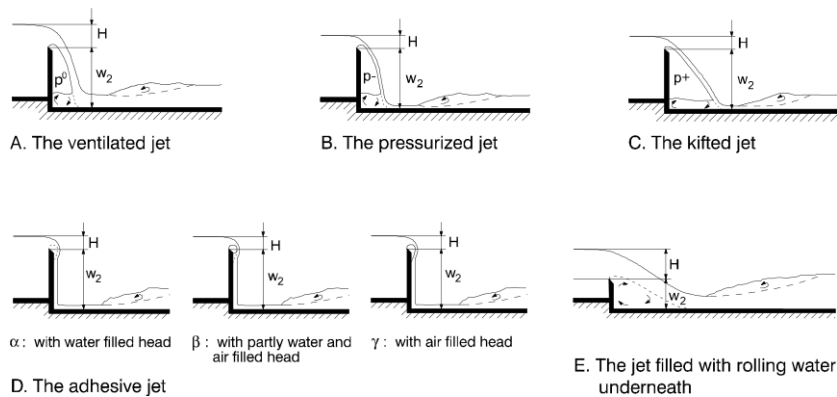

Figure 6.7 Classification of jet types for free flow



In reality each of these five jets can occur for every of the four different flow regimes i.e. all together 20 combinations. A detailed description of these different jet types and the conditions under which they occur can be found in /9/, pp 86-91.

In order to simplify the orifice, equations for the ventilated jet (case 1) for the free flow and the momentum equation for a filled jet (case 5) for the submerged case has been adopted, since these types are the most common. Furthermore a simplified correction for the downstream pressure is included.

Supercritical flow has not been considered.

Each of the supported flow regimes and jet types are described with standard flow equations, with a choice of methods and parameters that ensures a smooth transition between flow regimes.

6.7 Culvert

Culverts come in two different types: *User specified QH relations* and *Calculated QH relations*. The two types are described below.

6.7.1 User specified QH relations

A culvert with user specified QH relations is described by different algorithms for critical flow, drowned flow and full-pipe flow. The full-pipe flow case is divided into free outflow, drowned flow and submerged flow. A QH relationship must be input covering all cases of critical outflow flow and free outflow from the culvert.

Critical discharge is determined by a weir type formulation when the inlet is free, and an orifice type formulation when the inlet is submerged.

The flow through culverts is described using the following assumptions (/11/): The culvert is horizontal, and the friction loss inside the culverts is negligible.

Note! the friction losses can be incorporated into the QH relationship as discussed below.

Six different flow situations are distinguished depending on the upstream and downstream water levels. In the mathematical formulation these situations are reduced to four standard cases: zero flow, critical flow, drowned flow and submerged flow. The 6 different flow situations are presented in Figure 6.8.

In the case of full-pipe flow the actual flow situation is first determined using Figure 6.8. For case iv) the user specified QH relation is used, while for case v) and vi) the coefficients in the energy equation are determined by setting $h_s = \text{HSTMAX}$ where HSTMAX is the highest elevation-width relationship specified, and the width $b_s = 0$ in the structures equation for drowned flow, where h_s is the water elevation at the structure and b_s is the structure width.



The transition from case iv) to v) is handled as follows. The two discharges Q_{iv} and Q_v are calculated using the assumptions of case iv) and v), respectively. If $Q_v > Q_{iv}$ then flow case iv) is chosen.

In this figure the following relationships apply:

i) zero flow: $Q_s = 0$

ii) and (iv): critical flow and submerged flow with free outlet:

$$Q_s = Q(h_1) \text{ (according to tabulated input function)}$$

(iii), (v) and (vi): drowned flow, submerged flow with both backwater influence from outlet and where the downstream water level exceeds the top of the culvert:

$$h_1 + \frac{V_1^2}{2g} - \frac{\zeta}{2g} \left(\frac{Q_s}{A_s} \right)^2 = h_2 + \frac{V_2^2}{2g} \quad (6.18)$$

The losses due to friction along the length of a pipe can be incorporated into the QH relation during the critical flow period, and into the contraction and expansion loss coefficients during drowned flow. The Manning equation is typically used for this purpose.

If the culvert is a structure in a composite structure, the altered characteristics should be incorporated by the user into the QH relation.

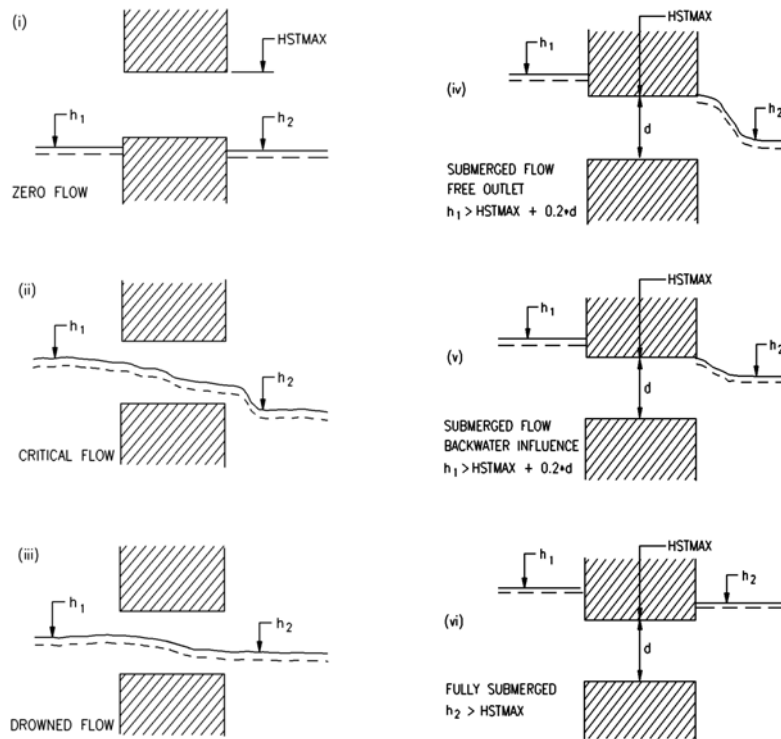

Figure 6.8 User specified culvert flow regimes

6.7.2 Calculated QH relations

- The Culverts, *QH* Relations Calculated structure is a more advanced treatment of the flow through a culvert than the Culverts, User Specified *QH* Relations structure described in the above section. The main differences are:
- The *QH* relationships are calculated by the MIKE 1D engine.
- The culvert can be assigned a length, friction coefficient, slope and bend loss coefficient in addition to the conventional parameters.
- The culvert cross section can be defined by a standard shape (e.g. circle or rectangle). A user defined cross section can also be provided as a depth versus width table.

The structure has been designed for modelling culverts of any shape, length or slope. All flow conditions are modelled, including full submergence, partial submergence, critical inflow and outflow, orifice flow and full culvert flow with a free outflow.



Specification

The culvert cross section shape is specified as either a standard shape (rectangle, circle), an irregular shape defined as a (depth or level)/width relation. Other required parameters are:

- Culvert length (m)
- Upstream and downstream invert levels (m)
- Number of parallel culverts
- Friction coefficient (Manning's n)
- Valve regulation switch which may be set as
 - Flow only in negative direction (decreasing chainage)
 - Flow in both directions (none)
 - Flow only in positive direction (increasing chainage)
- Closed/open cross section switch
- Coefficients in both positive and negative flow directions for:
 - Inflow losses (typically 0.5)
 - Outflow losses (typically 1.0)
 - Bend losses (straight culvert would be 0.0)
 - Free overflow correction coefficient (typically 1.0)

Flow descriptions

The flow through a culvert can be broadly classified into three areas for computational purposes. The flow conditions mentioned below are illustrated in Figure 6.9

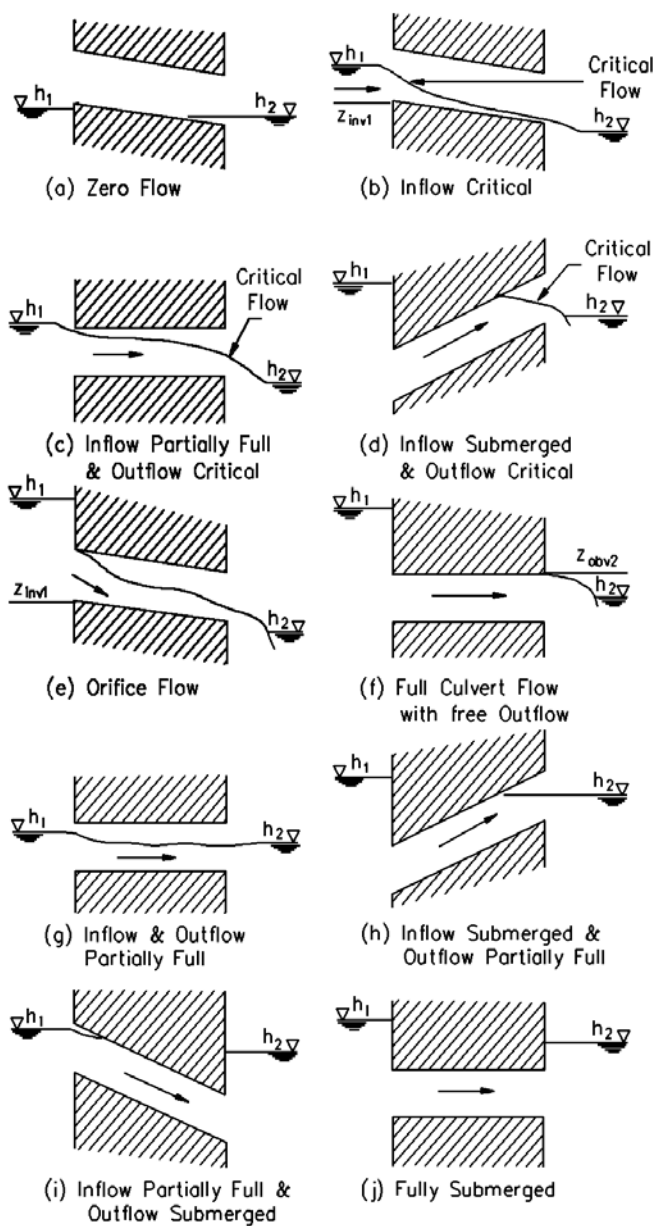

Figure 6.9 Calculated culvert flow conditions

Zero flow

The zero flow condition occurs when one of the following conditions exist:

- The culvert is dry



- The valve regulation switch is set to negative and the flow would be in a positive direction if the valve was open;
- The valve regulation switch is set to positive and the flow would be in the negative direction if the valve was open.

Upstream controlled flow

The upstream controlled flow condition occurs when the downstream water level has no influence on the discharge through the culvert. The discharge is therefore solely a function of the river water level at the culvert inflow, h_1 , and can be tabulated (QH relation) prior to the simulation, minimising the computational load during the simulation. The flow conditions modelled are:

- Critical inflow
- Partially full inflow and critical outflow
- Submerged inflow and critical outflow
- Orifice flow at inflow with free outflow
- Full culvert flow with free outflow

Expressions for the loss coefficients, momentum equation coefficients, upstream controlled flow (critical inflow or outflow, orifice flow at inflow and full culvert flow with free outflow) and downstream controlled (submerged) flow are described in detail in Appendix B.1. The transition between upstream and downstream control is also described in Appendix B.1.

Downstream controlled flow

Downstream controlled flow (or submerged flow) occurs when the downstream water level imposes a constraint on the flow through the culvert. The calculation of discharge is performed during a simulation because the discharge is a function of both upstream and downstream water levels and therefore is not practical to tabulate. The flow conditions modelled are:

- Partially full inflow and outflow
- Submerged inflow and partially full outflow
- Partially full inflow and submerged outflow
- Fully submerged

Construction of QH relationships

Calculation of the QH relationship for upstream controlled flow is a two step process. The two steps are given here.



The QH relationships (one for each flow direction) are presented for verification under the QH relations tab. For convenience, the relationships are given as the water depth, y_1 , versus Q , not h_1 versus Q . The value of h_1 is equal to the culvert invert level plus y_1 . The values of area and hydraulic radius are shown under the Hydraulic Parameters tab for verification purposes only. ■



First, the hydraulic parameters: area, hydraulic radius and critical flow, are tabulated for depths ranging from zero to full culvert depth. A cosine function is used for setting the tabulated depth values in order to give more detail at the bottom and top of the culvert cross sections where the variation of area and hydraulic radius is very non-linear.

If an irregular cross section shape is specified, and if the depth or level/width table has more than eight pairs of values, the depths in the depth (or level)/width table are used for calculating the hydraulic parameters, otherwise the cosine function is used. This provides the opportunity for the user to specify the depths at which the hydraulic parameters are to be calculated.

Second, h_1 is calculated for critical depths ranging from zero to that at 95% of the full culvert area. Whether the flow is critical at the inflow or outflow is determined according to the description above.

An iteration procedure is used to calculate h_1 because the contraction loss coefficient ζ_1 , and the inflow river cross section area A_1 are functions of h_1 .

At the start of a simulation a check is made to ensure that the distance between the upstream and downstream cross sections minus the culvert length is less than DXMAX. If this is not the case an error message is given. Note that there are no checks to ensure that the cross section locations and/or Topo ID between that used for calculating the QH relations and that used in the simulation. Ideally, the upstream and downstream cross sections should be located immediately upstream and downstream of the culvert.

When critical flow can no longer occur (submerged inflow and/or outflow), the flow condition will be either orifice flow or full culvert flow. The QH relationship continues to be constructed by calculating the discharge for increasing values of h_1 . The maximum value of h_1 in the tabulation is defined as the greater of (a) the top elevation in the adjacent cross section, and (b) five times the culvert depth above the invert.

If the inflow river water level exceeds the maximum h_1 value during a model simulation, a linear extrapolation is made based on the last two pairs of values in the QH relation.

Iteration procedures are also necessary for Q_o (orifice flow) and Q_p (primed flow). The discharge adopted is taken as the minimum of Q_o and Q_p . However, once Q_p is lower, full culvert flow occurs (i.e. $Q_p < Q_o$), and the culvert is assumed to remain flowing full, i.e. the culvert is "primed".

For each iteration procedure mentioned above, convergence usually occurs in two to three iterations except in the case when the culvert inflow cross section area, A_{s1} and A_1 are of similar magnitude, i.e. as ζ_1 approaches zero. A maximum number of one hundred iterations is allowed, and if exceeded a warning message is given. The QH relationships will be successfully calculated, but the user should check the adjacent cross section description and the culvert specifications.



If A_{s_1} is greater than A_1 or the Q values are decreasing with increasing h the calculation of the QH relationships is suspended and warning messages are given. The point in the QH relationships where the problem occurred can be observed by inspecting the QH tables.

Simulations will not be possible unless the QH relationships have been successfully calculated.

Note that if the Topo ID or the upstream and downstream cross sections are changed, the QH relationships have to be recalculated.

Closed / open section switch

A culvert can be modelled as an open section by setting the Closed / Open switch. An example where this may be used is a “long” weir where the friction along the length of the weir is of importance and/or the flow areas at the entrance and exit are significantly different.

If set to open, the culvert will never run full or even partially full, therefore only those flow conditions which represent a free water surface are modelled. When the water level is higher than the soffit the hydraulic parameters are calculated based on a cross section extended vertically upwards with a width equal to that at the soffit. For example, in the case of a rectangular cross section the height value is essentially redundant as the cross section will be modelled as an open cross section of constant width.

In the case of a circular cross section, this switch is invalid and the culvert will be assumed closed.

Flooded areas of adjacent h-grid points

The flooded or storage areas of the two adjacent h -grid points are reduced by half of the culvert length multiplied by the cross section width. In effect the culvert is considered to have a zero contribution to the storage of the system. In the rare case where the storage within the culvert is significant compared to that in the reach, the flooded areas at the adjacent h -grid points should be adjusted using the additional flooded area parameter, see Section 3.7 Flooded Areas and Relative Resistance (*p.* 47).

Velocities

The velocity through a culvert is calculated in one of three ways: 1) as Q/A_c in the case of critical inflow or outflow, where A_c is the critical flow area, 2) as Q/A_{full} in the case of orifice flow or full culvert flow, where A_{full} is the full cross section area of the culvert, or 3) as Q/S_{s_A} in case of downstream controlled flow. In the latter case, Q/S_{s_A} is equal to the mean of Q/S_{s_1} and Q/S_{s_2} , the culvert inflow and outflow cross section areas, respectively.

6.8 Weir Formula Structure

The Weir Formula structure models the discharge through a structure with standard weir formulas.

6.8.1 Weir Formula 1

The Weir Formula 1 is based on a standard weir expression simplified according to the Villemonte formula:

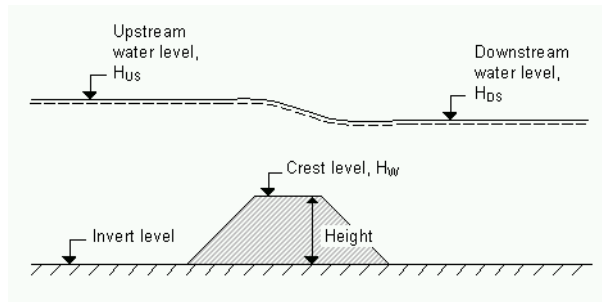

Figure 6.10 Definition of terms used in the three Weir Formula structures

$$Q = W \cdot C \cdot (H_{us} - H_w)^k \cdot \left[1 - \left(\frac{H_{ds} - H_w}{H_{us} - H_w} \right)^{k-0.385} \right] \quad (6.19)$$

Where Q is discharge through the structure, W is width, C is weir coefficient, k is the weir exponential coefficient, H_{us} is upstream water level, H_{ds} is downstream water level and H_w is weir level. (See Figure 6.10).

6.8.2 Weir Formula 2 (Honma)

The Weir Formula 2 is the Honma formula:

$$Q = \begin{cases} C_1 W (H_{us} - H_w) \sqrt{(H_{us} - H_w)} & \text{for } (H_{ds} - H_w)/H_{us} < 2/3 \\ C_2 W (H_{ds} - H_w) \sqrt{(H_{us} - H_{ds})} & \text{for } (H_{ds} - H_w)/H_{us} \geq 2/3 \end{cases} \quad (6.20)$$

Where Q is the discharge through structure, W is the width, C_1 is the first weir coefficient, $C_2 = (3/2)\sqrt{3}C_1$ is the second weir coefficient, H_{us} is the upstream water level, H_{ds} is the downstream water level and H_w is weir level. (See Figure 6.10).



6.8.3 Weir Formula 3 (extended Honma)

The Weir Formula 3 uses the extended Honma formula. The discharge is calculated in three flow regimes: 1) perfect flow, 2) imperfect flow, and 3) submerged overflow. The active regime is defined by the ratio between downstream and upstream water depth above the crest.

$$Q = \begin{cases} C_0 W h_u^{3/2} & \text{for } h_d/h_u \leq (h_d/h_u)_i \\ C_0(\alpha \cdot (h_d/h_u)^q + \beta) W h_u^{3/2} & \text{for other cases} \\ C_0(\gamma \cdot (h_d/h_u)^r + \delta) W h_d (h_u - h_d)^{1/2} & \text{for } h_d/h_u \geq (h_d/h_u)_s \end{cases} \quad (6.21)$$

where

$$C_0 = a \cdot (h_u/H)^p + b$$

W is weir width

H is weir height above cross section invert

h_d is the upstream water level above the crest

h_u is the down stream water level above the crest

$(h_d/h_u)_i$ is a user specified depth ratio limit between perfect and imperfect flow regime.

$(h_d/h_u)_s$ is a user specified depth ratio limit between imperfect and submerged flow regime.

$a, b, p, q, r, \alpha, \beta, \gamma$, and δ are user specified parameters.

NOTE: The MIKE 1D engine does not check if there is a continuous transition from one flow regime to the next. This has to be ensured by the user through proper selection of parameters.

6.9 Control Structures

Control Structures differ from other structure types in two important respects:

1. the structure may be described as either an underflow structure, an overflow structure, a radial gate or a sluice gate. Thus the structure may be described as either a movable weir or a sluice gate;
2. as for dambreak structures, it is not possible to define beforehand the critical flow characteristic ($Q-h$) relationship of the structure.



6.9.1 Hydraulic aspects - radial gates

In MIKE 1D, radial gates are automatically divided into an underflow part and an overflow part.

When specifying gate levels for a radial gate, the user should specify the level for the underflow part, i.e. the level of the bottom of the gate. The gate level for the overflow part is calculated based on geometric considerations.

Flow calculated through underflow part of radial gate.

Calculation of the flow through the underflow part depends on the flow regime at each time step.

For free flow conditions the discharge is calculated as:

$$Q_{free, underflow} = \tau \frac{\delta}{\sqrt{1 + \frac{\delta w}{y_1}}} a \sqrt{2gy_1} \quad (6.22)$$

where:

τ is a discharge calibration factor,

δ is the contraction coefficient,

g acceleration of gravity,

y_1 upstream water level,

w the vertical gate opening,

a the flow area through the gate (vertical gate opening multiplied with the width of the gate) and

The contraction coefficient, δ , is computed as:

$$\delta = 1 - 0,75(\theta/90^\circ) + 0,36(\theta/90^\circ)^2 \quad (6.23)$$

Where θ is the inclination angle of the gate relative to the canal bottom.

For submerged flow conditions the discharge is calculated as:

$$Q_{submerge, underflow} = \tau \frac{\delta}{\sqrt{1 - \left(\frac{\delta w}{y_1}\right)^2}} a \sqrt{2g(y_1 - y_2)} \quad (6.24)$$

where y_2 is the downstream water level.

Determination of actual flow regime is made at each time step of the simulation using the user defined parameters; 'Tran.Bottom' and 'Tran.Depth' (specified in the Graphical Interface for Radial Gate structures).



Free flow occurs if: $y_2 < y_{Limit} + y_{Tran,Bottom}$

Submerged flow occurs if: $y_2 > y_{Limit} + y_{Tran,Bottom} + y_{Tran,Depth}$

Limiting level, y_{Limit} is calculated as:

$$y_{Limit} = \frac{\delta W}{2} \left[\sqrt{1 + 16 \left(\frac{H}{\delta W} - 1 \right)} - 1 \right] \quad (6.25)$$

where H is the upstream energy head.

In the transition zone between free flow and submerged flow the discharge is calculated by using linear interpolation between (6.22) and (6.24).

Flow calculated above the Radial gate top level.

If upstream water level is higher than the top of the radial gate then water flows above the radial gate. The over flow is calculated as a function of the downstream water level conditions:

When downstream water level is lower than the top of the radial gate, the discharge is calculated using:

$$Q_{Overflow} = b\alpha y_1^\beta \quad (6.26)$$

where

b is the width of the gate,

α and β are user defined coefficients ('Weir Coeff' and 'Weir Exp').

When the downstream water level is above the top of the gate the discharge is calculated using:

$$Q_{Overflow} = b\alpha y_1^\beta \left[1 - \left(\frac{y_2}{y_1} \right)^{\beta-0,385} \right]$$

6.9.2 Hydraulic aspects - sluice gates

Sluice gates are physically similar to underflow gates.

The 'Sluice, Formula' type of gate is an underflow gate for which four different flow regimes exist. Each of these four flow regimes are described with its own equation defining the discharge across the spillway. In addition to the flow beneath the gate an 'over-the-top' flow is added to the solution. This happens when the upstream water level exceeds the top of the gate. The active flow regime in a given situation is determined by the values of up- and down-



stream water level and the gate position. The different flow regimes and when they apply are listed in Table 6.1.

Table 6.1 Flow regimes and when they apply

| Flow Condition | Equation | Restriction | Remarks |
|-----------------------------|---|--|---------------------------------|
| Controlled Submerged (CS) | $y_c = aG_0 \left(\frac{H-h}{G_0} \right)^b$ $Q = L \sqrt{gy_c^3}$ | $\frac{h}{G_0} \geq 1,0$ | Also known as submerged orifice |
| Controlled Free (CF) | $y_c = aG_0 \left(\frac{H}{G_0} \right)^b$ $Q = L \sqrt{gy_c^3}$ | $\left(\frac{h}{G_0} \geq 1,0 \right) \& \left(\frac{H}{G_0} \geq \frac{1}{K} \right)$ $K = \frac{2}{3}$ | Also known as free orifice |
| Uncontrolled Submerged (US) | $y_c = aH \left(1 - \frac{h}{H_0} \right)^b$ $Q = L \sqrt{gy_c^3}$ | $\frac{h}{G_0} < 1,0, \frac{H}{G_0} < \frac{1}{K} \& \frac{h}{H} \geq K$ $K = \frac{2}{3}$ | Also known as submerged weir |



Table 6.1 Flow regimes and when they apply

| Flow Condition | Equation | Restriction | Remarks |
|------------------------|--|--|------------------------------|
| Uncontrolled Free (UF) | $y_c = aH$ $Q = L\sqrt{gy_c^3}$ | $\frac{h}{G_0} < 1, 0, \frac{H}{G_0} < \frac{1}{K} \text{ \& } \frac{h}{H} \geq K$ $K = 2/3$ | Also known as free weir |
| Over-the-top | $Q = L\sqrt{gy_c^3}$ $y_c = a(H - HG - G_0)$ | $H > (HG + G_0)$ | Computed as a free weir flow |

H is the upstream water level measured above the sill level, h downstream water level measured above the sill level, g the acceleration of gravity, G_0 the gate opening, Hg the height of the gate, L the spill way width, y_c the critical depth and Q the discharge. H, Hg, h and G_0 are shown in sketch below.

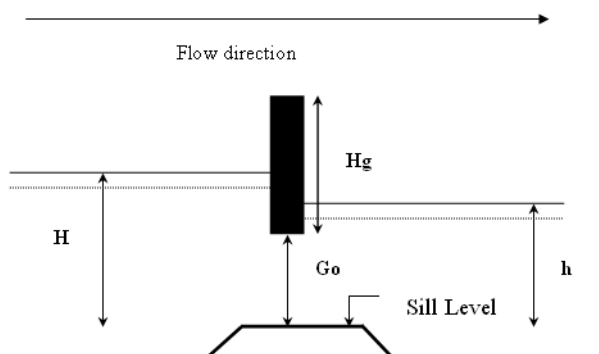

Figure 6.11 Sketch of sluice gate

In order to avoid instabilities due to too sharp limits between the different flow regimes it is possible to define an interval across which the solution varies from one flow type to another. This is done using the 'High Limit' and 'Low Limit' option supplied in the user interface.

6.9.3 Hydraulic aspects - overflow structures

The calculation of the discharge over a movable weir is identical to that of dambreak structures, i.e. a broad crested weir. The only difference is that the structure width is assumed to remain constant for control and structures.

6.9.4 Hydraulic aspects - underflow structures

The type of underflow structures considered in the control structure operation are rectangular in shape, with a vertical sliding or rotating section. The gate will only have a controlling influence on the flow if the gate level is lower than the upstream water level. If this is not the case, the discharge will be calculated assuming an overflow structure where crest level is taken as sill level, as described above.

If the upstream water level is higher than the gate level, the presence of the gate will force the passing water into a jet, the height of which is less than the gate height due to a severe convergence of streamlines just upstream of the gate. At the point of maximum contraction, called the 'vena contracta', the streamlines are once again parallel to the bed, and a hydrostatic pressure distribution may be assumed to occur here, see Figure 6.12

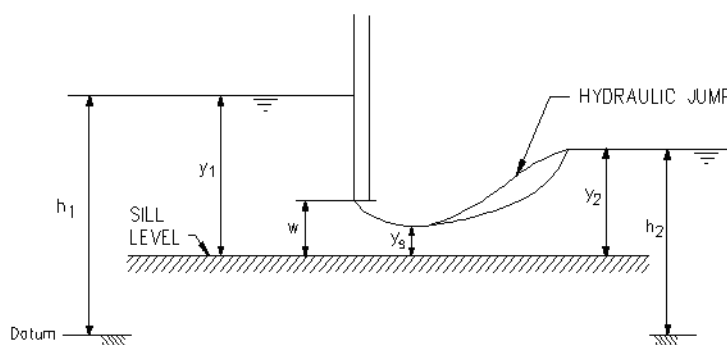

Figure 6.12 Flow under a vertical sluice gate

This contraction of the flow may cause the formation of supercritical flow in the region of the issuing jet. Should this occur in a channel with a high tail water level, a hydraulic jump may occur downstream of the gate. In either case, the discharge through the gate will be a function of the gate geometry and upstream water level only. This is termed free discharge.



As the tail water rises, the hydraulic jump moves upstream, towards the gate. When the jump reaches the gate, it will completely drown the supercritical jet, and the water level at this point will suddenly rise to the tail water depth. The change in flow at this instant is discontinuous, due to the discontinuous nature of the hydraulic jump itself. At the discontinuity, the discharge will suddenly decrease, and may only increase if the water level upstream of the gate also increases.

The minimum downstream water level at which the hydraulic jump is drowned may be calculated from the hydraulic jump equation:

$$y_2 = \frac{1}{2}y_s(\sqrt{1 + 8F^2} - 1) \quad (6.27)$$

where, y_s and y_2 are the water depths (measured above the sill) at the vena contracta and immediately downstream respectively and F is the Froude number corresponding to y_s .

6.9.5 Free flow

For a freely issuing jet (ie. not drowned), the gate discharge is a function of the gate geometry and upstream water level only. The magnitude of the discharge for a given opening will depend on the amount of contraction the jet experiences. The contraction coefficient, C_c , is a measure of this, and is defined as:

$$C_c = \frac{y_s}{\text{gate opening}(w)} \quad (6.28)$$

The contraction coefficient is dependent on the gate type: for a vertical sluice gate, C_c is in the region 0.61 - 0.63, whereas for a radial gate, the contraction coefficient is dependent on the gate level. The contraction coefficient in MIKE 1D is an input variable and is by default equal to 0.63.

Head losses across the structure are calculated from the standard MIKE 1D descriptions via the user defined values ζ_{in} and ζ_{out} .

The inflow head loss is assumed to occur in the region of accelerating flow between the point upstream of the gate and the vena contracta. It would be expected to have a value between 0.0 and 0.50. The outflow head loss occurs in the region of flow expansion, between the vena contracta and the next downstream h point. Theoretical values of between 0.8 and 1.0 have been calculated for vertical sluice gates, but in practice they can be considerably higher (/40/).

If the flow is determined as free, the energy equation may be applied between the point upstream of the structure and the vena contracta, to yield the free discharge through the gate. Assuming, as in most cases, a zero



inflow head loss, it can be shown that this equation is equivalent to the generally accepted form of the vertical sluice equation (/22/):

$$Q = C_d b w \sqrt{2g y_1} \quad (6.29)$$

where, b is the gate width and C_d is the effective discharge coefficient, calculated from:

$$C_d = \frac{C_c}{\sqrt{1 + C_c \frac{w}{y_1}}} \quad (6.30)$$

6.9.6 Drowned flow

If drowned discharge is detected, the energy equation is applied between points upstream and downstream of the structure. Note that in calculating the energy losses, the existence of a 'submerged' vena contracta is assumed, overlaid by a body of still water. The energy equation in this form corresponds to the submerged orifice equation of the form:

$$Q = C_d w b \sqrt{2g(h_1 - h_2)} \quad (6.31)$$

where C_d is the effective discharge coefficient and h_1 and h_2 are upstream and downstream water elevations respectively.

As mentioned previously, the change between free and submerged flow is discontinuous in nature, the free discharge being greater than the corresponding drowned discharge for the same water levels and gate opening. Such discontinuities will present numerical problems during a computation which may lead to instabilities and eventual termination of the computation. Hence, a coefficient, ψ , has been introduced in order to make a smooth transition. By use of this coefficient it is possible to expand the transition zone from free flow to drowned flow. The transition zone is defined as:

$$\frac{1}{2} y_s (\sqrt{1 - 8F^2} - 1)(1 - \psi) \leq y_2 < \frac{1}{2} y_2 (\sqrt{1 - 8F^2} - 1)(1 + \psi) \quad (6.32)$$

When downstream water level, y_2 , is within this interval the discharge through the structure will be calculated using an interpolation between the free flow equation and the drowned flow equation. The value of ψ can be set in the Mike11.ini file placed in the windows directory. The default value is zero corresponding to a discontinuity when changing from free flow to drowned flow. The user should only change this value if instabilities are encountered during the simulation. A rule is that the value of ψ should be as low as possible. A first guess at the value of ψ could be 0.01



6.10 Dambreak

A dambreak structure is a dam in which a breach can develop. The flow through a dam breach may be described in MIKE 1D through the use of the energy equation or alternatively through a calculation method as implemented in the National Weather Services (NWS) DAMBRK program. In the following the two methods are presented separately.

A dambreak structure consists of two underlying structures: A structure representing the flow over the crest (crest flow structure) and a structure representing the breach of the dam. The breach can be modelled in two different ways: As a failure of the crest (breach failure) or as piping failure of the dam (pipe failure) followed by breach failure.

6.10.1 Failure moment

The user may choose three different definitions of the failure moment, namely

- Time in the form of a historic date and time.
- Hours from start of simulation. The user specifies a time span in hours before the dam breaches.
- A reservoir water level. The reservoir water level is defined as the greatest of the water level on either side of the dam.

6.10.2 Energy equation based dam breach modelling

The flow at the dambreak structure is quite similar to a broad crested weir, but there are two differences:

1. The shape of the dam changes with time, i.e. the breach increases and the dam crest is shortened. As a consequence the critical flow characteristics ($Q-h$) relationship of the crest and of the breach cannot be calculated in advance.
2. the $Q-h$ relationship for the dam crest and the breach are different. Therefore the flow over the crest and the flow through the breach are calculated separately, see Figure 6.13.

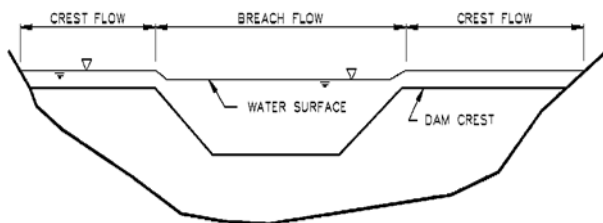

Figure 6.13 Combined flow over breach and crest

Trapezoidal breach geometry

During the development of the breach the trapezoid increases in size and changes shape.

The initial breach shape is described by three parameters as shown in Figure 6.14:

- Level of the breach bottom (HB)
- Width of the breach bottom (WB)
- Side slope of the breach (SS) (horizontal divided by vertical lengths). The left side slope and the right side slope are equal

The development of the breach can either be specified as a known function of time, or it can be calculated from the sediment transport capacity of the breach flow.

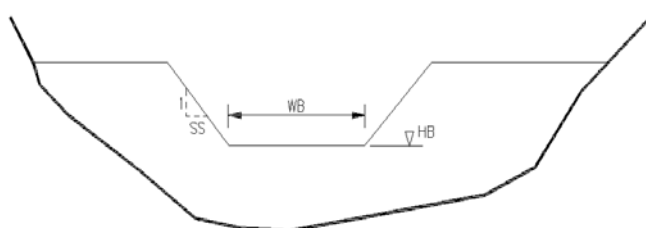

Figure 6.14 The parameters of the breach geometry

Known geometry breach development

If this method is used, then the parameters of the breach are given as a time series in a boundary. The time is relative to the start of the breach. Between the specified times the parameters are linearly interpolated as shown in Figure 6.15 for the trapezoidal case. The breach bottom level must not be above the crest level.

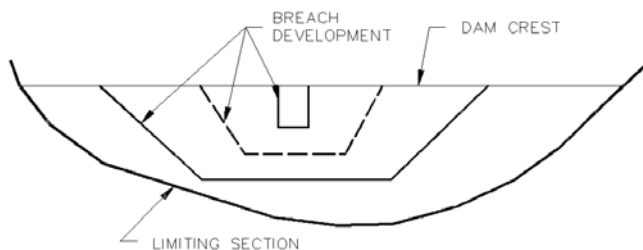

Figure 6.15 The breach is specified for example at times 0h and 1h. The dashed line would be the linear interpolation for time 0.5h

6.10.3 Erosion based breach development using the energy equation

If this mode is used, the initial and the final breach shape must be specified. The increase of the breach during a time step is calculated from the conditions in the breach itself. The Engelund-Hansen sediment transport formula is used (see the MIKE reference manual for *Non-cohesive sediment transport module*) to calculate the sediment transport in the breach.

As a first step, the flow resistance in terms of the total dimensionless shear stress is calculated, based on the Engelund formulation. This is then compared to the critical shear stress (the Shield's Criterion, defined by the user). If the computed shear stress is greater than the critical stress, then the sediment transport is calculated, otherwise it is set to zero.

The sediment transport rate, q_t , calculated from the Engelund-Hansen formula is in terms of m^2/s per metre-width of pure sediment only, and this must then be related to a change in bed (i.e. breach) level. It is assumed that the breach remains horizontal. From the given upstream and downstream slopes, the length of the breach in the flow direction, L_b , may be calculated. By application of the sediment continuity equation in the breach, the change in breach level dH_b in a time interval dt is given as:

$$\frac{dH_b}{dt} = \frac{q_t}{L_b(1 - \varepsilon)} \quad (6.33)$$

where,

H_b is the breach level

q_t is the sediment transport rate (m^2/s)

ε is the porosity of the sediment

L_b is the breach length in the direction of flow

t is time



Modelling the variation of the width of the breach perpendicular to the flow direction is more difficult to relate to the classical theories of sediment transport. This is because the theories for bed load and suspended load do not apply to the development of a wall boundary layer along the often very steep side walls of the breach. As an approximation, the sediment transport at the sloping walls is assumed to be proportional to that in the central part of the breach. The coefficient of proportionality, x , (side erosion index) relates the increase in breach width, W_b , to depth as:

$$\frac{dW_b}{dH_b} = 2x \quad (6.34)$$

Generally, the side erosion index is in the order of 0.5-1.0.

Erosion Based Piping Failure

An erosion based failure of a dam may be initially started by piping failure. In this case a flow forms through the dam wall. Erosion of the soil along the “pipe” causes the pipe to enlarge and the flow to increase. Eventually the dam will collapse into the void created by the piping failure erosion.

This failure scenario is modelled as an option in the erosion based breach development, i.e. there are two options for the initial failure process:

1. Initial failure by overtopping.
2. Initial failure by piping (after collapsing the erosion process returns to that of overtopping as described above).

The assumptions adopted for the piping failure are:

- The shape of the pipe is circular.
- The pipe is horizontal.
- The pipe must always be running full.

The location of the pipe centre in the dam cross section must be within the final breach shape and, if specified, the limiting section shape. When the circumference of the pipe extends outside these shapes, the hydraulic parameters are based on a reduced cross section as illustrated in Figure 6.16.

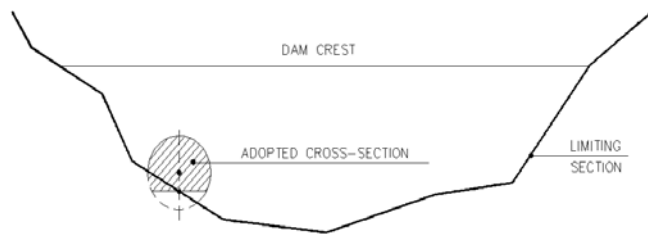

Figure 6.16 Adjustment of a pipe cross section

The point of collapse is defined by a ratio, which is specified by the user, of the pipe diameter to the distance between the dam crest and the pipe soffit as illustrated in Figure 6.17. Once this ratio is exceeded part of the dam is collapsed to form a breach.

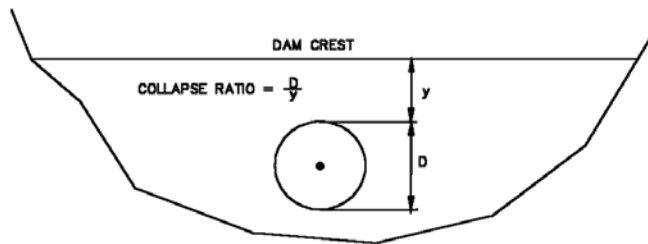

Figure 6.17 Definition of piping failure collapse ratio

The shape of the breach is illustrated in Figure 6.18. The bottom width is first set equal to the pipe diameter and the breach level to the pipe invert. Not all of the collapsed material will typically be carried out without depositing on the bed of the breach. This is accounted for by a volume loss coefficient, f_{lost} , which is the fraction of material assumed to be washed out immediately after collapse. The remaining material is evenly distributed on the breach bed as shown in Figure 6.18.

These calculations are made using cross section areas, not volumes, therefore, the length of the breach and consequently the upstream and downstream slopes of the dam faces are not taken into account.

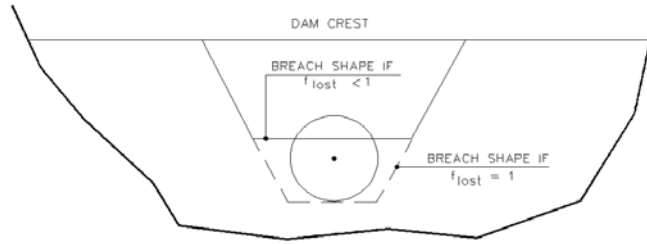

Figure 6.18 Breach shape after collapse

Other parameters required are the initial diameter of the pipe at the start of failure and the pipe roughness, k_s , which is used to calculate the Darcy friction factor, f , according to

$$\frac{1}{\sqrt{f}} = 2 \log_{10} \left(\frac{12R}{k_s} \right) \quad (6.35)$$

where, R is the hydraulic radius.

The discharge, Q_p , through the pipe is given by

$$Q_p = A \sqrt{\frac{2g\Delta H}{\left(1.5 + \frac{fL}{4R}\right)}} \quad (6.36)$$

where A is the flow area, L is the length of the pipe and ΔH is given by

$$\Delta H = h_1 - \max(h_2, z_{obv}) \quad (6.37)$$

where h_1 is the upstream water level, h_2 is the downstream water level and z_{obv} is the soffit of the pipe.

In Equation (6.33) an entrance head loss of half the velocity head in the pipe and, when there is a submerged outlet, an exit loss of one velocity head have been incorporated. Adopting a full velocity head loss in the latter case gives the transition between submerged flow and free outflow to be when the downstream water level, h_2 , equals the pipe soffit, z_{obv} . (See section 6.7.2 Calculated QH relations (*p. 112*), for a more detailed discussion.)

The enlargement of the pipe is based on the sediment transport relationship described above for breach erosion. The depth of water, y_p , used in calculating q_t is given by

$$y_p = \frac{h_1 + \max(h_2, z_{obv})}{2} - L_p + \frac{D}{2} \quad (6.38)$$



where D is the pipe diameter, and L_p is the level of the pipe centre.

By relating the volume of material eroded to the “effective” transport area (adopted here as the pipe length times half the circumference) the change in the pipe radius, ΔR_p , is defined as

$$\Delta R_p = C_{cal} \frac{q_t}{2L_p(1-\varepsilon)} \Delta t \quad (6.39)$$

where, C_{cal} is a “calibration” coefficient entered as one of the erosion parameters. No specific recommendation can be given for the value of C_{cal} . It has been provided so the user can adjust the rate of change of R_p if so desired, or data is available for calibrating the rate of formation of the pipe.

Limiting cross section

There may be a boundary of an irregular shape beyond which the breach will not develop. This limit may be the surface of hard rock or it may be the natural bottom of the valley. To allow for a boundary of this type, a cross section can be specified. In this case only the part of the trapezoid inside the cross section is used for calculation of the flow. This is illustrated in Figure 6.19.



Figure 6.19 The breach (shaded area) is the area of the trapezoid inside the limiting cross section

Flow calculations

Once the breach geometry has been computed the flow can be calculated.

The flow over the dam crest and the flow through the breach are often quite different with respect to water depth, velocity, and flow state. At the breach the water level is lower and the velocity is higher than at the dam crest. When the flow is drowned at the breach the flow at the crest may be either free overflow or drowned.

The flows through each structure are calculated separately using the upstream water level (h_1), the downstream water level (h_2) and the total flow (Q) from the last iteration. The flow over the crest structure and through the



breach structure is calculated as described in section A.2.4 Structures (p. 295).

6.10.4 NWS DAMBRK dam breach methods

There are two NWS DAMBRK methods:

- Breach failure
- Piping failure

The first of these uses a weir type equation to determine the flow through the breach and the latter is based on an orifice type equation. Both methods rely on the user specifying the full development of the breach geometry as a function of time.

Breach failure

The flow through the trapezoidal breach is given by

$$Q = c_v k_s [c_{weir} b \sqrt{g(h-h_b)}(h-h_b) + c_{slope} S \sqrt{g(h-h_b)}(h-h_b)^2] \quad (6.40)$$

where

- b the width of the breach bottom
- g is acceleration due to gravity
- h upstream water level (reservoir water level)
- h_b level of breach bottom
- S side slope of breach

c_{weir} is weir coefficient for horizontal part (=0.546430)

c_{slope} is weir coefficient for slope part (=0.431856)

c_v is correction coefficient for approach sections. This coefficient compensates for the loss in energy due to the inflow contraction.

k_s is correction coefficient due to submergence.

The weir coefficients have been made non-dimensional e.g.

$$c_{weir} \sqrt{g} = 0,546430 \sqrt{9,81 (\text{m/s}^2)} = 1,7115 (\text{m}^{1/2}/\text{s}) = 3,1 (\text{ft}^{1/2}/\text{s})$$

The correction coefficient for the approach section is determined through

$$c_v = 1 + \frac{c_B Q_p^2}{g W_R^2 (h - h_{b,term})^2 (h - h_b)} \quad (6.41)$$

where



c_B is non-dimensional coefficient (= 0.740256) termed the Brater coefficient
 W_R is reservoir width given by the undestroyed crest length.

$h_{b,term}$ is the terminal level of the breach bottom. The minimum level in the time series file.

Q_p is discharge through the breach in the previous iteration.

The submergence correction is determined through

$$k_s = \max\left(1 - 27,8 \left(\frac{(h_{ds} - h_b)}{(h - h_b)} - 0,67\right)^3, 0\right) \quad (6.42)$$

where h_{ds} is the downstream water level.

Piping failure

The flow through a piping failure is given by

$$Q = c_{orifice} A \sqrt{2g(h - \max(h_p, h_{ds}))} \quad (6.43)$$

where

$c_{orifice}$ Orifice coefficient (= 0.599769)

A Flow area in pipe given by

$$A = b(h_{pt} - h_b) + S(h_{pt} - h_b)^2 \quad (6.44)$$

h_{pt} Top of pipe

h_b Bottom of pipe

h_p Centre line of pipe given by

$$h_p = \frac{(h_{pt} + h_b)}{2} \quad (6.45)$$

The pipe may collapse either due to the top of the pipe reaching the crest level or if the water level upstream is not high enough to maintain pipe flow. The criteria for the latter is given by

$$h < \frac{3}{2}(h_{pt} - h_b) + h_b \quad (6.46)$$

Once the pipe has collapsed the flow is calculated based on the breach flow equations.

Crest flow

The flow over the crest of the dam is given by

$$Q = k_s c_{weir} b_c \sqrt{g(h - h_c)} (h - h_c) \quad (6.47)$$

where

h_c the crest level

b_c the remaining crest length (perpendicular to the flow)

and the submergence correction given by

$$k_s = \max\left(1 - 27,8 \left(\frac{h_{ds} - h_c}{h - h_c}\right)^3, 0\right) \quad (6.48)$$

Temporal development of breach geometry

Once the failure has initiated the temporal development of the breach will be read from a time series. This time series must contain values for

- The breach bottom.
- The breach side slope.
- The breach bottom width.

Further if piping failure is used the time series must also contain

- The upper level of the pipe.

This is illustrated in Figure 6.20.

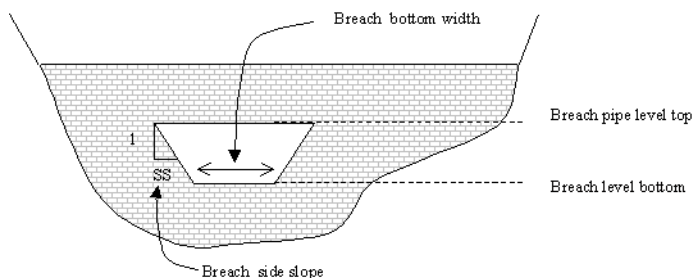

Figure 6.20 Definition of term used in the NWS DAMBRK routines



6.11 Bridges

MIKE 1D offers a number of approaches when modelling flow through bridges. The approach to choose should be based on the assumptions for the different methods and the requirements for the modelling.

The bridge modelling approaches can be divided into pure free flow methods and methods which may be combined with submergence/overflow methods. The pure free flow methods can be further sub-divided into methods for piers and methods for arches.

The methods specially designed for piers are

- Bridge Piers (Nagler) (*p. 141*): An orifice type of flow description with the effect of the piers taken into account through an adjustment factor.
- Bridge Piers (Yarnell) (*p. 142*): An equation derived from experiments for normal flow conditions in the sub critical flow range. Again the effect of piers is handled through the use of adjustment factors.

The free flow arch methods available are

- Arch Bridges (Biery and Delleur) (*p. 138*): An orifice type of equation is used to describe the discharge through the bridge. The equation is derived under the assumption of a rectangular channel and is based on a single span arch opening. Multiple arch openings are handled by a simple multiplication factor.
- Arch Bridges (Hydraulics Research (HR) method) (*p. 140*): The HR method is based on laboratory experiments of both single and multi spanned arch bridges in rectangular channels. The method uses tables describing the relation between the blockage ratio, the downstream Froude number and the upstream water level.

The methods than can be combined with both submergence and overflow methods are the following

- Energy Equation (*p. 144*): A standard step method where a backwater surface profile is determination is used to calculate the discharge through the bridge. The method takes the contraction and expansion loss for bridges of arbitrary shape into account. The method assumes sub-critical flow and may default to critical flow for steep water surface gradients.
- Federal Highway Administration (FHWA) WSPRO method (*p. 147*): The FHWA WSPRO method is based on the solution of the energy equation. Contraction loss is taken into account through the calculation of an effective flow length. Expansion losses are determined through the use of numerous experimentally based tables. The method takes the effect of eccentricity, skewness, wingwalls, embankment slope etc. into account through the use of these tables.



- US Bureau of Public Roads (USBPR) method (*p. 157*): The USBPR method estimates free-surface flow assuming normal depth conditions. The method is based on experiments and takes the effect of eccentricity, skewness and piers into account.

The submergence methods available are

- Pressure Flow, Federal Highway Administration method (*p. 159*): Two orifice equation descriptions are used. One for situations when the orifice is submerged downstream and modified equation for situations when only the upstream part of the orifice is submerged.
- MIKE 1D culvert: A standard MIKE 1D culvert description may be chosen for submergence flow. The culvert to be used is specified by the user. The culvert is only active if submergence occurs.
- Energy equation: The flow under the bridge is determined through a standard backwater step method. The flow is assumed to be in the sub-critical range and thus the method may default to critical flow. Both contraction and expansion loss is taken into account.

Overflow methods available are:

- Energy Equation: The flow over the bridge is determined through a standard backwater step method. The flow is assumed to be in the sub-critical range and thus the method may default to critical flow. Both contraction and expansion loss is taken into account.
- Road overflow, Federal Highway Administration method (*p. 162*): The overflow is modelled using a weir equation taking tail water submergence into account through the use of a submergence coefficient. The method may be used for both gravel and paved surfaces.
- MIKE 1D weir: A standard MIKE 1D weir description may be chosen for overflow. The weir to be used is specified by the user. The weir is only active if overflow occurs.

6.11.1 Arch Bridges (Biery and Delleur)

The Biery and Delleur method is specially designed for semi circular arch bridges. It does not consider skewness, eccentricity, entrance rounding or piers (*/20/*). The method is based on experiments carried out for a rectangular channel.

The discharge, Q , through a semicircular arch in a rectangular channel is calculated from:

$$Q = 0,7083 C_D (2g)^{1/2} Y_{us}^{3/2} b \left[1 - 0,1294 \left(\frac{Y_{us-Lim}}{r} \right)^2 - 0,0177 \left(\frac{Y_{us-Lim}}{r} \right)^4 \right] \quad (6.49)$$

where



- C_D Coefficient of discharge.
- g Acceleration due to gravity.
- Y_{us} Average water depth upstream of the bridge (= $\text{Area}_{us}/\text{Width}_{us}$).
- b Opening width of the arch.
- r Radius of curvature.

Given that the discharge will decrease for high values of Y_{us} a limit corresponding to the maximum discharge is set for Y_{us-Lim} :

$$Y_{us-Lim} = \begin{cases} Y_{us} & \text{for } \frac{Y_{us}}{r} < 1,49555 \\ 1,49555r & \text{for } \frac{Y_{us}}{r} \geq 1,49555 \end{cases} \quad (6.50)$$

The upstream depth Y_{us} is taken as the average depth in the upstream cross section. Upstream direction is based on the water level gradient. The coefficient of discharge C_D varies with the bridge opening ratio M and the downstream Froude number F_{ds} . The default table in MIKE 1D is for a semicircular arch models (15/).

The downstream Froude number F_{ds} is given by:

$$F_{ds} = \frac{Q}{A_{ds}\sqrt{gY_{ds}}} \sqrt{\alpha_{ds}} \quad (6.51)$$

Where

- Q Discharge.
- A_{ds} Total flow area of downstream cross section.
- α_{ds} Velocity coefficient in downstream cross section (see eq. (6.68)).
- g Acceleration due to gravity.
- Y_{ds} Average depth in downstream cross section (= $\text{Area}_{ds}/\text{Width}_{ds}$).

The bridge opening ratio M is defined as the ratio between b and B :

$$M = \frac{b}{B} \quad (6.52)$$

Where



- b Opening width of the arch (user defined).
- B Surface width at upstream cross section.

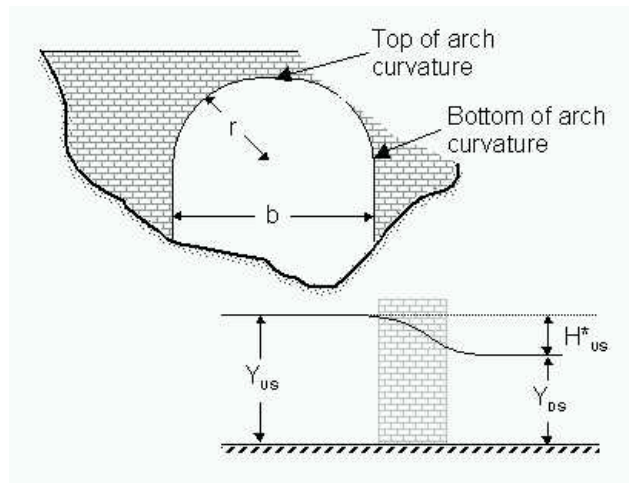

Figure 6.21 Hydraulic variables for Biery and Delleur and HR Arch Bridge.

The Biery and Delleur method assumes that the water surface is free i.e. submergence is not taken into account. If the bridge that is being modelled is submerged or over topped an alternative modelling method should be chosen.

6.11.2 Arch Bridges (Hydraulics Research (HR) method)

The Hydraulics Research method estimates the discharge through an arch bridge by the use of a table describing the relation between the upstream afflux, the blockage ratio and the Froude number. The upstream afflux is defined as the increase in water level from normal depth caused by the bridge. The afflux should theoretically be determined one bridge span upstream of the bridge. Thus as a rule of thumb the upstream cross section should be found one bridge span upstream the bridge opening. The default table in MIKE 1D is valid for semicircular arch models (15/).

H_{us}^* The afflux at the upstream cross section of the bridge.

Y_{ds} Average depth of flow downstream the bridge ($Area_{ds}/Width_{ds}$).

J_{us} The upstream blockage ratio defined as $J_{us} = \frac{b_{arch}}{b_{us}}$.

b_{arch} The user defined width of the arch.

b_{us} Upstream water surface width.

F_{ds} Froude number downstream of the bridge.



The upstream afflux is defined as:

$$H_{us}^* = h_{us} - h_{ds} - \left(\frac{Q}{K_{ds}}\right)^2 L_{us-ds} \quad (6.53)$$

Where:

h_{us} Water level at upstream cross section.

h_{ds} Water level at downstream cross section.

Q Discharge.

K_{ds} Conveyance in downstream cross section.

L_{us-ds} Distance from upstream to downstream cross section.

MIKE 1D determines the discharge based on the upstream and downstream water level. From the afflux and the upstream blockage ratio a Froude number can be determined through the use of the table expressing the relation between afflux and Froude number. For fixed water levels the Froude number depends solely on the discharge. Since the afflux depends on the discharge an iterative process is needed. If the iterative process does not converge the code defaults to critical discharge at the upstream cross section.

The hydraulic research method assumes that the water surface is free i.e. submergence is not taken into account. If the bridge that is being modelled is submerged or over topped an alternative modelling method should be chosen.

6.11.3 Bridge Piers (Nagler)

The Nagler equation is experimentally based. The equation is applicable to bridge piers with different pier shapes. The pier shape is taken into account through a so-called coefficient of discharge which is found through a table based on the pier type. The equation is derived from free flow experiments and is not accurate for high velocities (17).

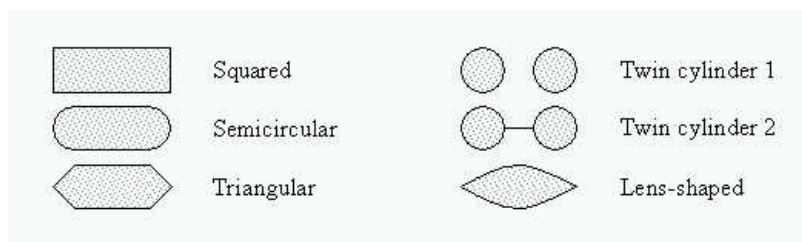

Figure 6.22 Type of pier shapes.



The Nagler equation reads:

$$Q = K_N b \sqrt{2g} \left(Y_{ds} - \theta \frac{V_{ds}^2}{2g} \right) \left(h_{us} - h_{ds} + \beta \frac{V_{us}^2}{2g} \right)^{1/2} \quad (6.54)$$

where:

- K_N Coefficient of discharge.
- θ Adjustment factor (default 0.3).
- β Adjustment factor varies with the bridge opening ratio.
- g Acceleration due to gravity.
- Y_{ds} Depth downstream of the bridge.
- V_{us} Velocity upstream the bridge.
- V_{ds} Velocity downstream the bridge.
- h_{us} Water level in the upstream cross section.
- h_{ds} Water level in the downstream cross section.
- b The total bridge opening width excluding the piers.

The coefficient of discharge K_N varies with the bridge opening ratio M and the pier shape. The adjustment factor β varies with the bridge opening ratio M and the adjustment factor θ can normally be taken as 0.3. The default tables in MIKE 1D are after Yarnell and Nagler.

The bridge opening ratio M is defined as the ratio between the flow width in the bridge and the flow width upstream of the bridge b/B .

- b Opening width of the arch.
- B Opening width at upstream cross section.

Eq. (6.54) can be rewritten as a polynomial of third degree in the discharge squared. In case of multiple roots the smallest positive root is chosen as the solution.

The structure area is defined as the arch width times the minimum water depth upstream or downstream.

6.11.4 Bridge Piers (Yarnell)

Like the Nagler equation, the Yarnell equation considers different pier shapes (see Figure 6.22). The pier shape is accounted for through the so-called pier



coefficient. The Yarnell equation is a pure experimentally based equation. The equation assumes free flow. Thus if submergence and possible overtopping is to be modelled an alternative method should be used.

The Yarnell equation reads:

$$h_{us} - h_{ds} = KY_{ds}F_{ds}^2(K + 5F_{ds}^2 - 0,6)(\alpha + 15\alpha^4) \quad (6.55)$$

$$F_{ds}^2 = \frac{Q^2}{A_{ds}^2 2gY_{ds}} \quad (6.56)$$

$$\alpha = 1 - \frac{b}{B_{us}} \quad (6.57)$$

where

K Yarnell's Piers shape Coefficient.

g Acceleration due to gravity.

Y_{ds} Depth downstream the bridge.

F_{ds} Froude number downstream the bridge.

α Channel contraction ratio.

A_{ds} Total flow area of downstream cross section.

b The bridge opening width excluding the piers.

B_{us} The width of the upstream cross section.

h_{us} Water level in the upstream cross section.

h_{ds} Water level in the downstream cross section.

The default tables for pier shape coefficient K are after Yarnell.

Eq. (6.55) may be re-written as a polynomial of second order in the Froude number squared. If multiple positive roots are present the greatest discharge is chosen.

The structure area is defined as the arch width times the minimum water depth upstream or downstream.



6.11.5 Energy Equation

The energy equation may be used to determine the discharge and the back water profile through the bridge. The energy equation takes friction loss and contraction/expansion losses into account. The method requires four cross sections (see Figure 6.23). River cross sections one and four are defined in the cross-section editor. Bridge cross sections two and three are defined through the bridge geometry in the network editor. Ideally the distance between the bridge and the up- and downstream cross-sections should be of the order b , where b is the bridge opening width. The latter is to ensure that the streamlines are parallel at section one and section four.

The equation solved from section i to $i-1$ reads

$$h_{i-1} + h_{v(i-1)} = h_i + h_{vi} + h_{f(i,i-1)} + h_{e(i,i-1)} \quad (6.58)$$

where:

h_i Water level at cross-section i .

h_{vi} Velocity head at cross-section i .

$h_{f(i,i-1)}$ Friction losses between cross-section i and $i-1$.

$h_{e(i,i-1)}$ Expansion losses between cross-section i and $i-1$.

The velocity head is defined as

$$h_v = \frac{\alpha Q^2}{2gA^2} \quad (6.59)$$



with the velocity distribution coefficient defined as

$$\alpha = \frac{\sum_{i=1}^N (k_i^3 / a_i^2)}{K^3 / A^3} \quad (6.60)$$

$$k_i = \frac{a_i r_i^{2/3}}{n_i} \quad (6.61)$$

$$K = \sum_{i=1}^N k_i \quad (6.62)$$

$$A = \sum_{i=1}^N a_i \quad (6.63)$$

Where

- Q Discharge at the section.
- α Velocity distribution coefficient.
- k Subsection conveyance.
- a Subsection area.
- K Total cross section conveyance.
- A Total cross section area.
- r Hydraulic radius.
- n Manning's roughness coefficient.
- N Number of subsections.

Eq. (6.68) is based on a parallel channel analysis. Each parallel channel being defined through subsections. A subsection is understood as segments in series with a constant relative resistance. Further a sub-division may also be achieved through the use of markers 4 and 5. Thus for a cross section with constant relative resistance and no markers 4 or 5 the velocity coefficient is unity.



Friction loss

The friction loss between cross-sections i and $i-1$ is calculated from:

$$h_{f(i,i-1)} = \frac{L_{i,i-1} Q^2}{K_i K_{i-1}} \quad (6.64)$$

Where:

$L_{i,i-1}$ The flow length in the approach reach.

K_i The conveyance for cross-section i .

Expansion/Contraction loss

Expansion/contraction losses are only considered from section 4 to section 3 and from section 2 to section 1. The expansion/contraction loss from section i to section $i-1$ is expressed as

$$h_{e(i,i-1)} = C \left| \frac{\alpha_i V_i^2}{2g} - \frac{\alpha_{i-1} V_{i-1}^2}{2g} \right| \quad (6.65)$$

where C is the contraction/expansion coefficient. This coefficient is non-dimensional and is user defined with a value between 0 and 1. The default values are 0.3 for contraction and 0.5 for expansion indicating that the losses due to expansion are typically larger than the losses due to contraction.

The solution method

The energy equation method assumes that the flow through the bridge is sub-critical. Further the method is an iterative method. The bridges are pre-calculated based on a set of values for the water levels upstream and downstream. Thus for each set of water level values a discharge is to be determined. The algorithm for determining the discharge has the following steps:

1. Initial guess for the discharge.
2. Backwater calculation from section 4 to section 3.
3. Backwater calculation from section 3 to section 2 based on the result from step 2.
4. Backwater calculation from section 2 to section 1 based on the result from step 3.
5. The water level determined through step 4 is compared with the actual water level at section 1.



6. Based on the comparison in step 5 the discharge is either modified and the algorithm returns to step 2 or the algorithm terminates if the deviation is within acceptable limits.

Throughout the calculation the results are compared with critical flow. If the solution found is below critical water level or if one of the steps 2 - 4 do not converge the code defaults to critical flow at that location. Further if the maximum number of iterations (default 50) is reached without obtaining a valid solution the code defaults to critical flow at section one.

6.11.6 Federal Highway Administration (FHWA) WSPRO method

The computations of the Federal Highway Administration's WSPRO computer program have been adapted for the calculation of free-surface flow. Some modifications have been necessary in order to fit the MIKE 1D terminology.

The method is based on a standard step method using the energy equation to find the discharge and the backwater water surface profile through the bridge. The method requires four cross sections (see Figure 6.23). River cross sections one and four are defined in the cross-section editor. Bridge cross sections two and three are defined through the bridge geometry in the network editor. Ideally the distance between the bridge and the up- and downstream cross-sections should be of the order b , where b is the bridge opening width.

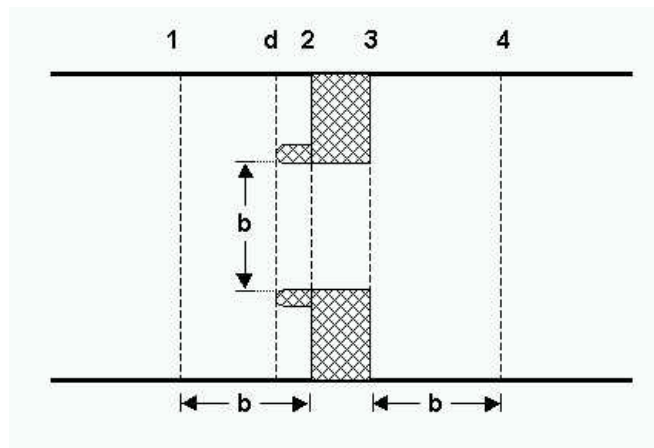

Figure 6.23 Location of cross-sections.

The total energy equation between section one and four can be written:

$$h_1 + h_{v1} = h_4 + h_{v4} + h_f + h_e \quad (6.66)$$

where:



h_1 Water level at cross-section 1.

h_{v1} Velocity head at cross-section 1.

h_4 Water level at cross-section 4.

h_{v4} Velocity head at cross-section 4.

h_f Friction losses between cross-section 1 and 4.

h_e Expansion losses between cross-section 3 and 4.

The velocity head is defined as

$$h_v = \frac{\alpha Q^2}{2gA^2} \quad (6.67)$$

with the velocity distribution coefficient defined as

$$\alpha = \frac{\sum_{i=1}^N (k_i^3 / a_i^2)}{K^3 / A^3} \quad (6.68)$$

$$k_i = \frac{a_i r_i^{2/3}}{n_i} \quad (6.69)$$

$$K = \sum_{i=1}^N k_i \quad (6.70)$$

$$A = \sum_{i=1}^N a_i \quad (6.71)$$

Where

Q Discharge at the section.

α Velocity distribution coefficient.

k Subsection conveyance.

a Subsection area.

K Total cross section conveyance.

A Total cross section area.



- r Hydraulic radius.
- n Manning's roughness coefficient.
- N Number of subsections.

Eq. (6.68) is based on a parallel channel analysis. Each parallel channel being defined through subsections. A subsection is understood as segments in series with a constant relative resistance. Further a sub-division may also be achieved through the use of markers 4 and 5. Thus for a cross section with constant relative resistance and no markers 4 or 5 the velocity coefficient is unity.

Friction loss

Without spur dykes the friction loss between cross-sections 1 and 2 is calculated from:

$$h_{f(12)} = \frac{L_{av}Q^2}{K_1K_2} \quad (6.72)$$

With spur dykes the friction loss between cross-sections 1 and 2 is augmented with the friction along the dykes:

$$h_{f(12)} = \frac{L_{av}Q^2}{K_1K_2} + \frac{L_{d2}Q^2}{K_2K_2} \quad (6.73)$$

Where:

L_{av} The effective flow length in the approach reach (see below).

L_{d2} The spur dyke length.

K_1 The conveyance for cross-section 1.

K_2 The conveyance for cross-section 2.

The friction loss from section 2 to 3 is given by

$$h_{f(23)} = \frac{L_{waterway}Q^2}{K_2K_3} \quad (6.74)$$

Where:

$L_{waterway}$ is the distance from section 2 to section 3.

K_3 The conveyance for cross-section 3.



Finally the friction loss from section 3 to section 4 is given by

$$h_{f(34)} = \frac{L_{34} Q^2}{K_3 K_4} \quad (6.75)$$

Where:

L_{34} The flow length from section 3 to 4.

K_4 The conveyance for cross-section 4.

Effective flow length

The effective flow length is determined based on the conveyance distribution. The effective length is determined as the average length of 20 equal conveyance tubes. The conveyance is here taken as

$$K = \int_0^B M(H-z)^{5/3} dx \quad (6.76)$$

Eq. (6.76) is found by taking the limit of N parallel stream-tubes as N tends to infinity

$$\lim_{N \rightarrow \infty} \sum_{i=1}^N M_i A_i R_i^{2/3} = \lim_{N \rightarrow \infty} \sum_{i=1}^N M_i (H-z_i) \Delta x_i (H-z_i)^{2/3} \quad (6.77)$$

Using eq. (6.76) for determining the conveyance has the advantage that the locations of the equal conveyance tubes are well defined. Using eq. (6.76) one can express the location of the first tube as

$$\frac{K}{20} = \int_0^{x_1} M(H-z)^{5/3} dx \quad (6.78)$$

which is to be solved for x_1 . For the second tube the equation to be solved is

$$\frac{K}{20} = \int_{x_1}^{x_2} M(H-z)^{5/3} dx \quad (6.79)$$

and so on for the remaining tubes.

The effective flow length is determined under the assumption that the water level in section 1 and 2 are equal. The error made here is minimal since the



main contribution to the calculation of the effective flow length is the contraction width which typically does not vary strongly with the water level changes considered here.

Definition sketches of the assumed streamlines are shown in Figure 6.24 and Figure 6.25. The length of a stream tube depends on the location of the upstream cross section. If the upstream distance is greater than the optimal distance L_{opt} the length is calculated according to Figure 6.24. If the optimal length is greater than the physical distance the stream tubes are assumed to be located as sketched in Figure 6.25.

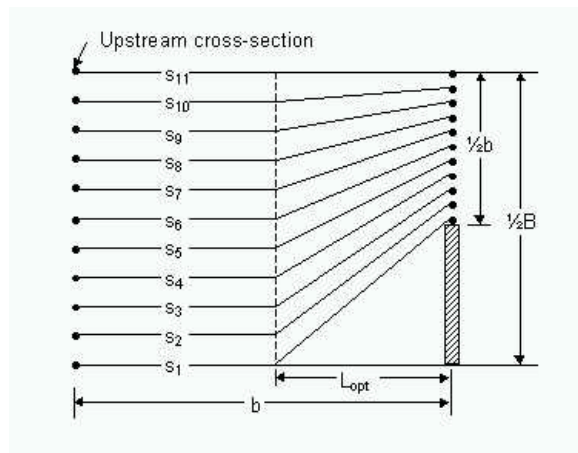

Figure 6.24 Definition sketch of assumed streamlines for low degrees of contraction.

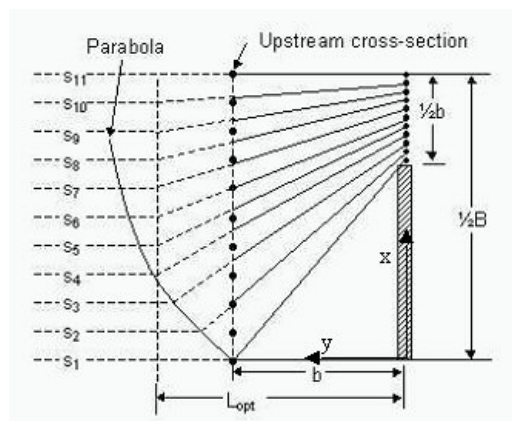

Figure 6.25 Definition sketch of assumed streamlines for high degrees of contraction.



The optimum length is defined as:

$$L_{opt} = \frac{b}{\pi(1-m')} \Phi \quad (6.80)$$

where

$$m' = 1 - b/B \quad (6.81)$$

$$\Phi = \frac{1}{2} \ln \left[\left(\sqrt{\frac{8}{\varepsilon^2} + 8} - \frac{3}{\varepsilon} - \varepsilon \right) \left(-\sqrt{8 + 8\varepsilon^2} - 3\varepsilon - \frac{1}{\varepsilon} \right) \right] - \ln \left(\varepsilon - \frac{1}{\varepsilon} \right) \quad (6.82a)$$

$$\varepsilon = 1 + \delta + \sqrt{\delta^2 + 2\delta} \quad (6.82b)$$

$$\delta = \frac{2}{\tan^2 \left[\left(1 - \frac{b}{2B} \right) \pi \right]} \quad (6.82c)$$

Where:

b The total bridge opening width excluding the piers.

B The total width of the upstream cross section.

Effective flow length:

$$L_{av} = \frac{1}{20} \left[\sum_{i=2}^{20} S_i + \frac{(S_1 + S_{21})}{2} \right] \quad (6.83)$$

In case the optimal length is greater than the physical distance a parabola is used to describe the stream tubes. Using a coordinate system as indicated in Figure 6.32 and the equation used for the right hand side of the channel is given by:

$$x = \frac{1}{2b}(y^2 - b^2) \quad (6.84)$$

similarly the left hand side uses a parabola described by

$$x = B - \frac{1}{2b}(y^2 - b^2) \quad (6.85)$$



Expansion loss

The contraction loss from section 1 to 2 is taken into account through the use of an effective flow length as opposed to the physical distance from section 1 to section 2. No contraction or expansion loss is assumed from section 2 to 3. It is further assumed implicitly that from section 3 to section 4 only expansion takes place. If no expansion takes place the loss consists solely of the friction loss from section 3 to 4.

The expansion loss from section 3 to 4 is computed from:

$$h_e = \frac{Q^2}{2gA_4^2} \left[2\beta_4 - \alpha_4 - 2\beta_3 \left(\frac{A_4}{A_3} \right) + \alpha_3 \left(\frac{A_4}{A_3} \right)^2 \right] \quad (6.86)$$

$$\beta_3 = \frac{1}{C} \quad (6.87)$$

$$\alpha_3 = \frac{1}{C^2} \quad (6.88)$$

$$\beta_4 = \frac{\sum(k^2/a)}{K^2/A} \quad (6.89)$$

$$\alpha_4 = \frac{\sum(k^3/a^2)}{K^2/A^2} \quad (6.90)$$

Where:

- C Coefficient of discharge
- k Subsection conveyance $k = Mar^{2/3}$
- a Subsection area
- K Total cross section conveyance $K = \sum k$
- A Total cross section area $A = \sum a$

Eqs. (6.89) and (6.90) are based on a parallel channel analysis. Each parallel channel being defined through subsections. A subsection is understood as segments in series with a constant relative resistance. Further a sub-division may also be achieved through the use of markers 4 and 5. Thus for a cross section with constant relative resistance and no markers 4 or 5 the velocity coefficient is unity.



Coefficient of discharge

The coefficient of discharge is a function of the bridge geometry and flow characteristics. Four main types of openings are defined Figure 6.26 to Figure 6.29. For each opening type the coefficient of discharge, C is obtained by a base coefficient C' and a number of adjustment factors, k . The default base coefficients and adjustment factors in MIKE 1D are obtained as described by FHWA /19/.

The coefficient of discharge, C is given by:

$$C = C' \cdot k_F \cdot k_y \cdot k_x \cdot k_\theta \cdot k_e \cdot k_j \cdot k_a \cdot k_b \cdot k_d \tag{6.91}$$

Table 6.2 Adjustment factors

| Adjustment factor | | Type | Tabular function of: |
|-------------------|---------------------------------|------|------------------------------------|
| C' | Base coefficient | All | m , L/b and slope |
| k_F | Froude number | I | F_3 |
| k_r | Corner rounding | I | m and r/b |
| k_w | Wingwall | I | m , w/b and WW |
| k_y | Average depth | II | m , $(Y_a + Y_b)/(2b)$ and slope |
| k_x | Unwetted abutment | III | x/b , L/b and slope |
| k_θ | Wingwall | IV | m , WW and slope |
| k_e | Eccentricity | All | K_a/K_c |
| k_j | Piles | All | m and j |
| k_j | Piers | All | m , L/b and j |
| k_a | Elliptical spur dike angularity | All | m and L_d/b |
| k_b | Straight spur dike offset, | All | m and L_d/b_d |
| k_d | Spur dike length | All | m and L_d/b |

Where:

- m Channel contraction ratio.
- L Bridge waterway flow length (length from section 2 to 3).
- b Bridge opening width.
- F_3 Froude number in downstream bridge section.



r Radius of corner rounding.

w Wingwall width.

WW Wingwall angle.

$(Y_a + Y_b)/(2b)$ Average water level in bridge section.

x Unwetted abutment length.

$K_a/K_c \leq 1$ Ratio of conveyance of the approach section on each side of the projected opening.

$j = A_p/A_3$ Portion of waterway blocked by piers/piles.

L_d Spur dike length.

b_d Spur dike offset.

The channel contraction ratio, m is given by:

$$m = 1 - \frac{K_q}{K_1} \quad (6.92)$$

Where:

K_q The conveyance of that part of section 1 where conveys discharge can flow through the bridge opening without contraction.

K_1 The total conveyance for cross-section 1.

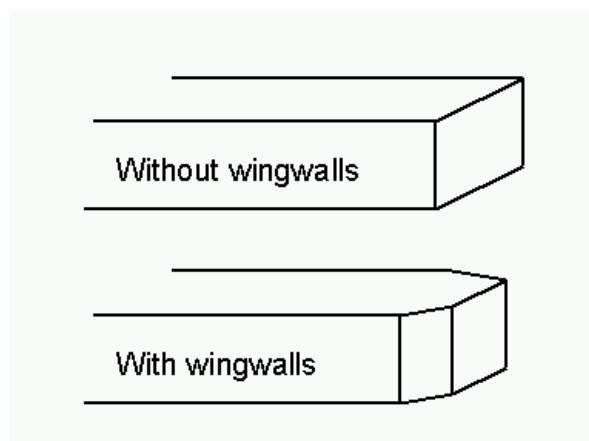

Figure 6.26 Definition sketch of type I opening, vertical embankments and vertical abutments, with or without wingwalls (after Matthai).

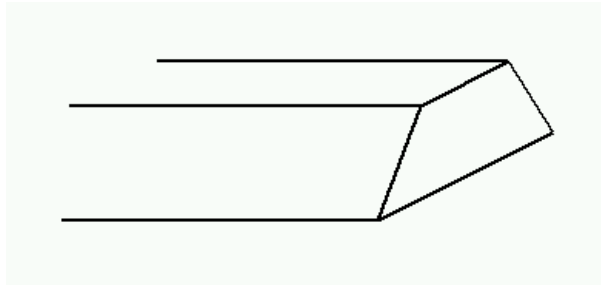

Figure 6.27 Definition sketch of type II opening, sloping embankments without wingwalls (after Matthai).

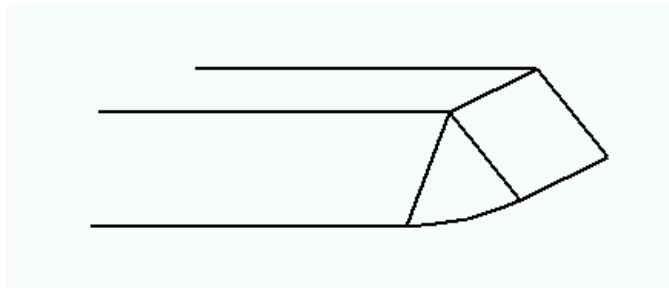

Figure 6.28 Definition sketch of type III opening, sloping embankments and sloping abutments (spillthrough) (after Matthai).

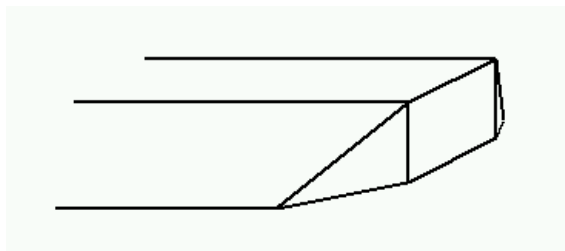

Figure 6.29 Definition sketch of type IV opening, sloping embankments and vertical abutments with wingwalls (after Matthai).

If the abutments are of different types a value of the coefficient of discharge is obtained through a weighted average:

$$C = \frac{C_L K_L + C_R K_R}{K_L + K_R} \quad (6.93)$$

Where:

C_L Coefficient of discharge for left abutment.



C_R Coefficient of discharge for right abutment.

K_L Conveyance for left side.

K_R Conveyance for right side.

The solution method

The method assumes that the flow through the bridge is sub-critical. Further the method is an iterative method. The bridges are pre-calculated based on a set of values for the water levels upstream and downstream. Thus for each set of water level values a discharge is to be determined. The algorithm for determining the discharge has the following steps:

1. Initial guess for the discharge.
2. Backwater calculation from section 4 to section 3.
3. Backwater calculation from section 3 to section 2 based on the result from step 2.
4. Backwater calculation from section 2 to section 1 based on the result from step 3.
5. The water level determined through step 4 is compared with the actual water level at section 1.
6. Based on the comparison in step 5 the discharge is either modified and the algorithm returns to step 2 or the algorithm terminates if the deviation is within acceptable limits.

Throughout the calculation the results are compared with critical flow. If the solution found is below critical water level or if one of the steps 2 - 4 do not converge the code defaults to critical flow at that location. Further if the maximum number of iterations (default 50) is reached without obtaining a valid solution the code defaults to critical flow at section one.

6.11.7 US Bureau of Public Roads (USBPR) method

The USBPR method estimates free-surface flow assuming normal depth conditions. The maximum afflux H_1^* at section 1 (see Figure 6.23) is here defined by:

$$H_1^* = k^* \frac{\alpha_2 V_{N2}^2}{2g} + \alpha_1 \left[\left(\frac{A_{N2}}{A_4} \right)^2 - \left(\frac{A_{N2}}{A_1} \right)^2 \right] \frac{V_{N2}^2}{2g} \quad (6.94)$$

Where:

k^* The backwater coefficient.

V_{N2} Average velocity in bridge section at normal depth.



A_{N2} Cross section area at normal depth.

A_1 Cross section area at section 1.

A_4 Cross section area at section 4.

g Acceleration due to gravity.

α_1 Velocity distribution coefficient - Equation (6.68).

α_2 Velocity distribution coefficient for normal depth.

The velocity distribution coefficient, α_2 is a function of α_1 and the opening ratio. The opening ratio defined by

$$M = 1 - b/B \quad (6.95)$$

where b is the bridge opening width and B is the width of the upstream river cross-section. In MIKE 1D the coefficient is computed from a user defined table or the pre-computed default table.

The total backwater coefficient is given by:

$$k^* = k_b^* + \Delta k_e^* + \Delta k_\phi^* + \Delta k_p^* \quad (6.96)$$

Where:

k_b^* Base coefficient. Tabular function of the opening ratio.

Δk_e^* Eccentricity coefficient. Tabular function of the opening ratio and the eccentricity.

Δk_ϕ^* Skewness coefficient. Tabular function of the opening ratio and skewness angle ϕ .

Δk_p^* Bridge pier coefficient. Tabular function of opening ratio, the portion of waterway blocked by piers and pier type.

The eccentricity e is given by

$$e = \frac{\min(Q_{\text{left}}, Q_{\text{right}})}{\max(Q_{\text{left}}, Q_{\text{right}})} \quad (6.97)$$

where Q_{left} , Q_{right} are the ratio of discharge of the approach section on each side of the projected opening. The portion of the waterway blocked by piers is user defined and should be understood as the ratio of the pier cross sectional area to the cross sectional area of the waterway without the piers.



The coefficients are computed in MIKE 1D from user defined tables or from the pre-computed default tables.

6.11.8 Multiple Waterway Opening

When working with multiple openings each opening is evaluated separately. Up- and downstream cross sections are reduced to the part found in between the stagnation points. The stagnation points are the points in the cross section where the flow splits up between the different water way openings. The default stagnation points are evaluated strictly from a geometric point of view. The default stagnation points are set so each sub cross section satisfies:

$$B_{sub} = \frac{b}{b_{Total}} B_{total} \quad (6.98)$$

Where:

B_{sub} Width of sub cross section.

b Bridge opening width from marker 1 to 3

b_{Total} Total width of all bridge openings.

B_{Total} Total width of cross section from marker 1 to 3.

The user can set the stagnation points if desired.

6.11.9 Pressure Flow, Federal Highway Administration method

During significant contact of the water surface with the girders of the bridge structure, free-surface flow cannot exist and pressure flow is established.

Fully Submerged Orifice flow

Discharge through the fully submerged bridge opening is computed by:

$$Q_{orifice} = C_D A_2 \sqrt{2g(h_1 - h_{f12} + h_{v1} - h_3)} \quad (6.99)$$

Where:

A_2 Flow area in the bridge opening.

g Acceleration due to gravity.

h_1 Water level in the upstream cross section.

h_{v1} Velocity head at cross-section 1.

h_3 Water level in the downstream bridge section.

h_{f12} The friction loss from the upstream cross section to the upstream bridge section.

C_D Discharge coefficient (default 0.8).

The friction loss is expressed as

$$h_{f12} = \frac{L_{12} Q_t^2}{K_1 K_2} \quad (6.100)$$

where the flow length is either the effective length or the physical length depending on the free bridge modelling method. The discharge Q_t is the total discharge including possible overflow. The conveyance at sections 1 and 2 are calculated as defined in eqs. (6.69)-(6.71).

The water level in sections 2 is given by

$$h_2 = h_1 - h_{f12} \quad (6.101)$$

and the water level at section 3 is obtained from solving the appropriate version of the energy equation from section 4 to section 4.

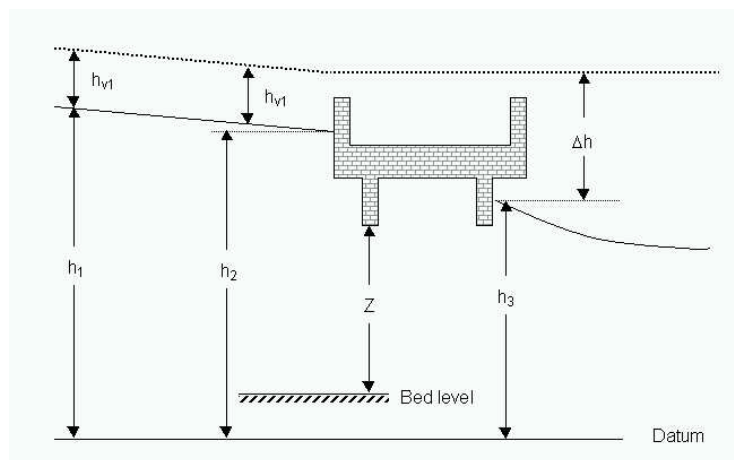

Figure 6.30 Definition sketch for submerged orifice flow.

Orifice flow

If the water surface is only in contact with the bridge bottom on the upstream side of the bridge the discharge is found through:

$$Q = C_D A_2 \sqrt{2g(Y_2 - Z/2 + h_{v1})} \quad (6.102)$$

Where:



C_D Discharge coefficient. Tabular function of Y_2/Z .

The quantities are defined in Figure 6.31 note that the bed level is defined as

$$\text{Bed Level} = b_{\text{bottom}} - Z \quad (6.103)$$

where b_{bottom} is the bridge bottom level and $Z = A_2/B_2$. The quantity A_2 being the area at the opening and B_2 is the width at the bridge bottom level.

Equation (6.102) may be rewritten as

$$Q = C_D A_2 \sqrt{2g \left(h_1 - h_{f12} + h_{v1} - \left(b_{\text{bottom}} - \frac{Z}{2} \right) \right)} \quad (6.104)$$

which is a form equivalent to equation (6.99). Note that the discharge coefficient in the two equations are different. To ensure a smooth transition from free orifice flow to submerged orifice flow a linear transition is made on the discharge coefficient from free to submergence. That is for water levels below the level $b_{\text{bottom}} - Z/2$ the free submergence coefficient is used whereas as the water level increases downstream and the orifice slowly becomes drowned the coefficient changes continuously into the fully submerged value. Further to avoid an abrupt change in the solution when the downstream water level reaches the bottom of the bridge the orifice equation is modified as

$$Q = C_D A_2 \sqrt{2g (h_1 - h_{f12} + h_{v1} - \hat{h}_3)} \quad (6.105)$$

where the modified downstream water level \hat{h}_3 is given by

$$\hat{h}_3 = \min (h_3, b_{\text{bottom}} - Z/2) \quad (6.106)$$

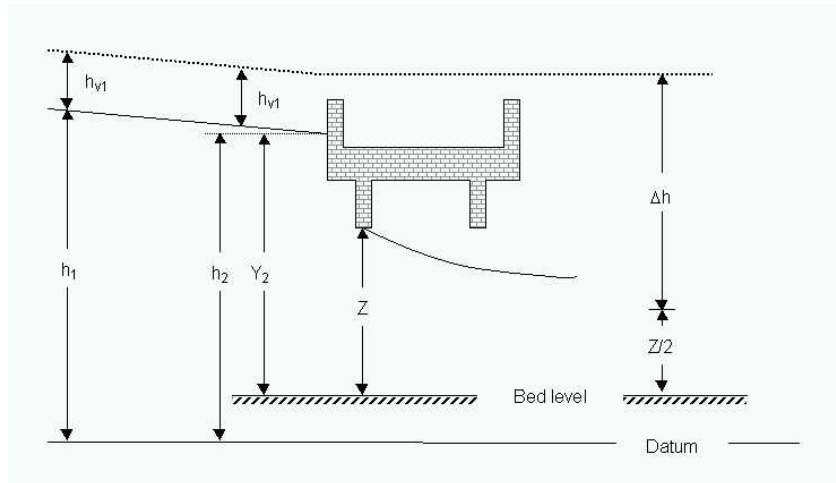

Figure 6.31 Definition sketch for orifice flow.

6.11.10 Road overflow, Federal Highway Administration method

When the water surface elevation exceeds the top bridge level the top part of the bridge is assumed to function as a weir. The discharge for the overflow part is computed using a weir formula:

$$Q = k_t C_f B_W H^{3/2} \quad (6.107)$$

Where:

H Total head for weir flow with respect to bridge top level (see Figure 6.32).

k_t Adjustment factor due to possible submergence from downstream water level. Tabular function of tail water level h_t and total head H .

C_f Coefficient of free discharge. Tabular function of water depth on the structure h_s , the crest length in the flow direction L_R and the total head H .

B_W Width of overflow part.

The submergence adjustment factor k_t depends on the ratio of minimum elevation along the top of the embankment h_t to the total head for weir flow H .

The total head for weir flow is given by:

$$H = h_1 + h_{v1} - L_{12} \frac{Q_{Tot}^2}{K_1^2} - h_{weir} \quad (6.108)$$



Where:

h_1 Water level at cross section 1.

h_{v1} Velocity head at cross-section 1.

L_{12} Distance between section 1 and section 2.

Q_{Tot} Total discharge including under flow through the bridge.

K_1 Conveyance for cross-section 1.

h_{weir} Crest level.

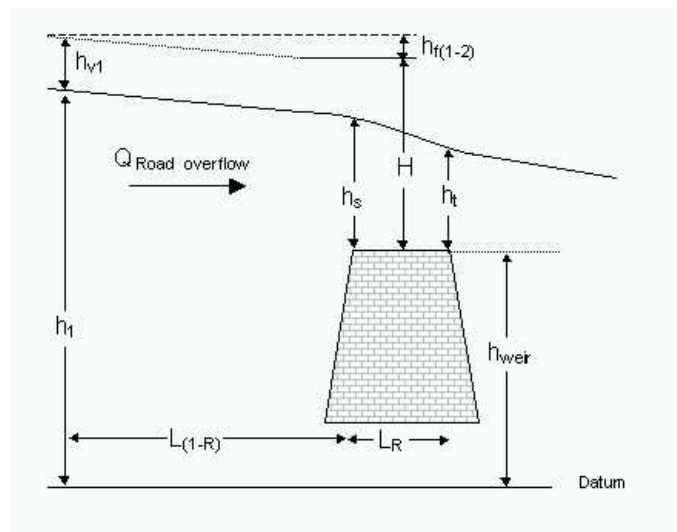

Figure 6.32 Definition sketch for road overflow.

6.11.11 Trouble shooting for bridge structures

During the simulation the discharge through a bridge is determined from a pre-calculated table. Each value in the table is found by an iteration process. Using a pre-calculated table decreases the calculation time.

Instability

For bridge structures a number of factors can result in instabilities.

Time step: In most cases it is helpful to decrease the MIKE 1D time step.

Delta: Delta is a default value in the HD editor. Increasing delta reduces instabilities. The delta value controls the time centering in the scheme.



Bridge preprocessing: To speed up simulations the bridges are preprocessed initially at simulation start. The generated H-Q-H tables are saved into files named using the bridge ID. In the present version the files are exported in the dfs2 format which can be readily viewed using standard tools within MIKE Zero. It is recommended to evaluate these files for consistency. Note that non-smooth H-Q-H surfaces may be caused by abrupt changes in bed friction or geometry.



Further consult MIKE11.ini for further capabilities with regards to bridge preprocessing.

Results

'Curtains': 'Curtains' in the result curve may be a result of the pre-calculated table. Increasing the resolution in the pre-calculated table will generally decrease the 'curtain' size.



BRIDGE_TABLE_GRID_UPSTREAM and BRIDGE_TABLE_GRID_DOWNSTREAM in MIKE11.ini may be used to specify a different resolution for the water levels used for the pre-calculated tables. The default value is 0.1 meters. The value is given in meters.



7 Rainfall Runoff

7.1 General Information

7.1.1 Runoff models available in the 1D engine

As in MIKE+ and MIKE 11, different surface runoff computation concepts are available in the 1D engine. The following table lists the existing models and the corresponding name in the different interfaces:

Table 7.1 Surface runoff computation concepts

| 1D engine | MIKE+ | MIKE 11 |
|---------------------------|----------|---------------|
| NAM | NAM | RDII |
| Time/area | Model A | Urban A |
| Kinematic Wave | Model B | Urban B |
| Linear Reservoir (global) | Model C1 | Not available |
| French Linear reservoir | Model C2 | Not available |
| UHM | UHM | UHM |

Surface runoff computations in the 1D engine can be based on any of these concepts, provided that the necessary data have been specified for each catchment specified in the set-up. Moreover, in one simulation run it is possible to combine different runoff computation concepts for various model areas.

NAM: A lumped, conceptual rainfall-runoff model, simulating the overland-, inter- flow, and base-flow components as a function of the moisture contents in four storages.

Time/area: In the Time-Area the shape of the runoff hydrograph is controlled by the concentration time and by the time-area (T-A) curve.

Kinematic Wave: The concept of this surface runoff model is founded on the kinematic wave computation, which is using the Manning equation.

Linear Reservoir (global): The linear reservoir surface runoff model is founded on the routing through a linear reservoir.

French Linear reservoir: This surface runoff model is an extension of the Global Linear Reservoir model, where two linear reservoirs in series are used for the routing of the runoff.



UHM: The Unit Hydrograph Module includes different loss models (constant, proportional) and the SCS method for estimating storm runoff.

7.1.2 Organisation of runoff model data

Use of different runoff models for the same catchment in subsequent simulations may result in very different simulated runoff. This is because each of the models uses different set of input data and model parameters, as well as different runoff computation concept. It is therefore of utmost importance to understand the background for the runoff computations applied in each of the models, as well as the meaning and interpretation of the various data and model parameters.

The runoff model data and model parameters are organised in the following clusters:

- Model-specific catchment data
- Model parameters

The model-specific catchment data comprise different sets for each of the models. These data basically provide further information about the geometry of the catchments and a more or less detailed land use description. Reference to a specific parameter set is also a part of this group.

Model parameters are organised in parameter sets. A parameter set is comprised of all editable parameters needed to execute certain type of runoff computation. Surface runoff computation for an individual catchment is based on the parameters contained in the set associated with the catchment.

7.2 NAM Rainfall Runoff Model

7.2.1 Introduction

The NAM hydrological model simulates the rainfall-runoff processes occurring at the catchment scale. NAM forms part of the rainfall-runoff (RR) module of the 1D river modelling system. The rainfall-runoff module can either be applied independently or used to represent one or more contributing catchments that generate lateral inflows to a river network. In this manner it is possible to treat a single catchment or a large river basin containing numerous catchments and a complex network of rivers and channels within the same modelling framework.

NAM is the abbreviation of the Danish “Nedbør-Afstrømnings-Model”, meaning precipitation-runoff-model, also named RDII in English standing for Rainfall Dependent Inflow and Infiltration model. This model was originally developed by the Department of Hydrodynamics and Water Resources at the Technical University of Denmark /32/.



A mathematical hydrological model like NAM is a set of linked mathematical statements describing, in a simplified quantitative form, the behaviour of the land phase of the hydrological cycle. NAM represents various components of the rainfall-runoff process by continuously accounting for the water content in four different and mutually interrelated storages. Each storage represents different physical elements of the catchment. NAM can be used either for continuous hydrological modelling over a range of flows or for simulating single events.

The NAM model can be characterised as a deterministic, lumped, conceptual model with moderate input data requirements. A description of the classification of hydrological models is given in Abbott and Refsgaard (1996) /4/. Refsgaard and Knudsen (1997) /36/ compare a number of different types of hydrological model, including the NAM model, in terms of both data requirements and model performance.

The NAM model is a well-proven engineering tool that has been applied to a number of catchments around the world, representing many different hydrological regimes and climatic conditions.

7.2.2 Model structure

A conceptual model like NAM is based on physical structures and equations used together with semi-empirical ones. Being a lumped model, NAM treats each catchment as a single unit. The parameters and variables represent, therefore, average values for the entire catchment. As a result some of the model parameters can be evaluated from physical catchment data, but the final parameter estimation must be performed by calibration against time series of hydrological observations.

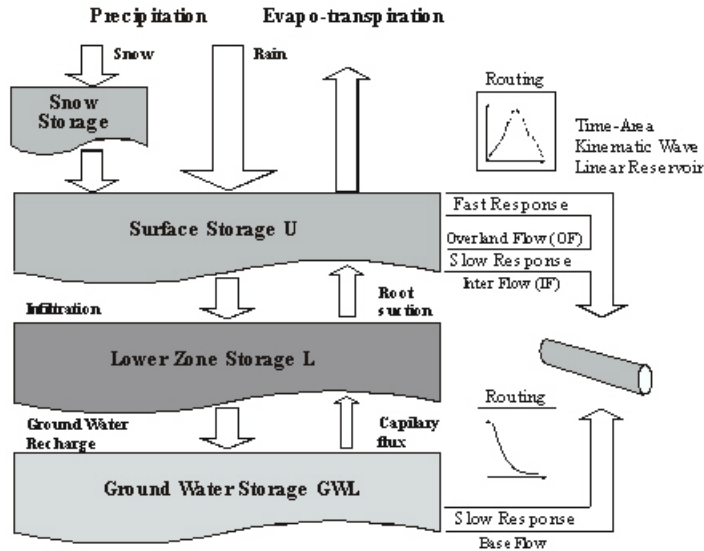

Figure 7.1 Model structure of the NAM

The model structure is shown in Figure 7.1. It is an imitation of the land phase of the hydrological cycle. NAM simulates the rainfall-runoff process by continuously accounting for the water content in four different and mutually interrelated storages that represent different physical elements of the catchment. These storages are:

- Snow storage
- Surface storage
- Lower or root zone storage
- Groundwater storage

In addition NAM allows treatment of man-made interventions in the hydrological cycle such as irrigation and groundwater pumping.

Based on the meteorological input data NAM produces catchment runoff as well as information about other elements of the land phase of the hydrological cycle, such as the temporal variation of the evapotranspiration, soil moisture content, groundwater recharge, and groundwater levels. The resulting catchment runoff is split conceptually into overland flow, interflow and baseflow components.

The rainfall passing through the snow storage is controlled by the temperature conditions and the current amount of snow on the catchment surface.

Moisture interception on the vegetation, as well as water trapped in depressions and in the upper-most cultivated part of the ground is represented as surface storage.



Moisture in the root zone, a ground layer below ground surface from where the vegetation can draw water for transpiration, is described as a storage in the lower ground zone, i.e. root zone storage.

The amount of water in the surface storage is continuously diminished by evapo-transpirative consumption set as potential evapo-transpiration, as well as by horizontal leakage (interflow) in the upper ground level. In situations when there is a maximum surface storage achieved, some of the excess water will enter the streams as overland flow, whereas the remainder is diverted as infiltration into the lower zone and further as percolation into the groundwater storage.

Moisture in the lower zone is subject to consumptive loss from evapo-transpiration. This process starts when the surface storage is completely exhausted, and in that situation the actual evaporation depends on the relative contents of the moisture in the lower zone. Additionally, the amount of moisture in the lower zone influences the process of overland flow and amount of water that enters the groundwater storage as recharge.

7.2.3 Data requirement

The basic input requirements for the NAM model consist of:

- Model parameters
- Initial conditions
- Meteorological data
- Streamflow data for model calibration and validation

The basic meteorological data requirements are:

- Rainfall
- Potential evapotranspiration

In the case of snow modelling the additional meteorological data requirements are:

- Temperature
- Radiation (optional)

The NAM model also allows modelling of man-made interventions in the hydrological cycle in terms of irrigation and groundwater pumping. In this case time series of irrigation and groundwater abstraction rates are required.

In this section the meteorological and hydrological data are described. The model parameters and initial conditions are described in the subsequent sections.

Meteorological data

Rainfall



Rainfall data are specified either as depth or as intensity (the latter is only available from the MIKE+ interface). ■

The time resolution of the rainfall input depends on the objective of the study and on the time scale of the catchment response. In many cases daily rainfall values are sufficient, but in rapidly responding catchments where accurate representation of the peak flows is required, rainfall input on a finer resolution may be required.

For validation process, resolution of the rainfall time series should correspond to the time resolution of measured discharges, e.g. daily average discharges.

Rainfall data with any (variable) time increments can be specified in the rainfall input. The NAM model will then make the necessary interpolations according to the simulation time step.

Potential evapotranspiration

The evapotranspiration is a physical process where water is transformed into vapor. Real evaporation or, more correctly, the actual evaporation includes evaporation from snow and ground surfaces of all types, interception from vegetation and its transpiration.

Interception is a part of rainfall that never reaches the ground but adheres to the vegetation and thereafter evaporates. Transpiration is water evaporation from inner surfaces in the plants, leaves and needles.



The evapotranspiration specified in NAM model is the potential evaporation i.e. possible evaporation as a depth or intensity (the latter is only available from the MIKE+ interface). ■

When daily time steps are used, monthly values of potential evapotranspiration are usually sufficient. In this case only minor improvements can be obtained by specifying daily values instead of monthly values. For small time steps, however, the diurnal variation of the evapotranspiration may be important.

Temperature

Temperature data are required if snow accumulation and melt are included in the simulations. The temperature is specified in degree Celsius (°C).

The resolution in time for the temperature especially concerns areas where the snow melting process is of great importance. During the snow season, the time increments in the temperature data should reflect the length of the time step in the simulation, e.g. daily mean temperatures.

The temperature data at a given time represents the average temperature since the last entered data.



Radiation

Actual incoming short wave radiation data can optionally be used as input in the extended snow module. The radiation data are specified in W/m^2 . The value at a given time represents the average radiation since the last entered data. ■



Mean area weighting

The NAM model simulates the rainfall-runoff process in a lumped fashion so provision is given for combining meteorological data from different stations within a single catchment or sub-catchment into a single time series of weighted averages. The resulting time series will represent the mean area values of rainfall and potential evapotranspiration for a catchment.

The weights are user-defined and can be determined based e.g. on the Thiessen method. In the case of missing values the weighting procedure will redistribute the weights appropriately. Therefore, it is not necessary to specify weight combinations for all possible combinations of missing stations. Alternatively, the user can explicitly specify the weights when data are missing from one or more stations. A weight of “-1” is given to non-reporting stations, indicating missing data.

When rainfall data are available from stations with different reporting frequency, e.g. both daily and hourly stations, then the distribution in time of the average catchment rainfall may be determined using a weighted average of the high-frequency stations. It is possible to use all stations to determine the daily mean rainfall over the catchment and subsequently use the hourly stations to distribute this daily rainfall in time. Different weight combinations for different cases of missing values may be applied also to the calculation of the distribution in time. ■

Hydrological data



Discharge

Observed discharge data at the catchment outlet are required for comparison with the simulated runoff for model calibration and validation, they are specified as discharge (e.g. m^3/s). The discharge data at any particular time is the average discharge since the last entered data. ■



Irrigation

If the irrigation module is included in the NAM simulation, an additional rainfall time series is required to provide information on the amount of irrigation water. The data are specified as depth. ■



Groundwater abstraction

When the effect of groundwater abstraction is expected to have a significant effect on the overall groundwater levels or catchment baseflow, pumping rates can be specified to account for these withdrawals. The groundwater abstraction data are treated as accumulated totals where the abstraction associated with any particular time is the abstraction since the last entered value. The data are specified as depth. ■

7.2.4 Basic modelling components

The implemented conceptualisation of the physical processes treated by NAM model is illustrated in Figure 7.1 and exposed below in full detail.

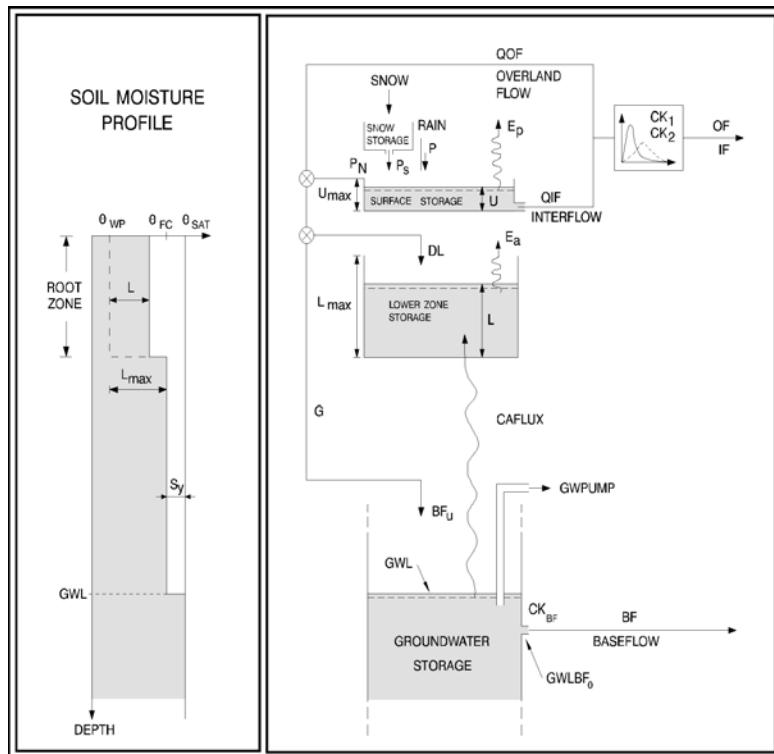

1997-fmcl\Nam-1.cdr\al

Figure 7.2 Conceptual model of NAM

Surface storage

Moisture intercepted on the vegetation as well as water trapped in depressions and in the uppermost, cultivated part of the ground is represented as surface storage. U_{max} denotes the upper limit of the amount of water in the surface storage.

The amount of water, U , in the surface storage is continuously diminished by evaporative consumption as well as by horizontal leakage (interflow).

When the surface storage spills, i.e. when $U > U_{max}$, some of the excess water, P_N , will enter the streams as overland flow, whereas the remainder is diverted as infiltration into the lower zone and groundwater storage.



Lower zone or root zone storage

The soil moisture in the root zone, a soil layer below the surface from which the vegetation can draw water for transpiration, is represented as lower zone storage. L_{max} denotes the upper limit of the amount of water in this storage.

Moisture in the lower zone storage is subject to consumptive loss from transpiration. The moisture content controls the amount of water that enters the groundwater storage as recharge and the interflow and overland flow components.

Evapotranspiration

Evapotranspiration demands are initially met at the potential rate from the surface storage. If the moisture content U in the surface storage is less than these requirements ($U < E_p$), the remaining fraction is assumed to be withdrawn by root activity from the lower zone storage at an actual rate E_a . E_a is proportional to the potential evapotranspiration and varies linearly with the relative soil moisture content, L/L_{max} , of the lower zone storage

$$E_a = (E_p - U) \frac{L}{L_{max}} \quad (7.1)$$

Overland flow

When the surface storage spills, i.e. when $U > U_{max}$, the excess water P_N gives rise to overland flow as well as to infiltration. QOF denotes the part of P_N that contributes to overland flow. It is assumed to be proportional to P_N and to vary linearly with the relative soil moisture content, L/L_{max} , of the lower zone storage

$$QOF = \begin{cases} CQOF \frac{L/L_{max} - TOF}{1 - TOF} P_N & \text{for } L/L_{max} > TOF \\ 0 & \text{for } L/L_{max} \leq TOF \end{cases} \quad (7.2)$$

Where:

$CQOF$ Overland flow runoff coefficient ($0 \leq CQOF \leq 1$)

TOF Threshold value for overland flow ($0 \leq TOF \leq 1$)

The proportion of the excess water P_N that does not run off as overland flow infiltrates into the lower zone storage. A portion, ΔL , of the water available for infiltration, $(P_N - QOF)$, is assumed to increase the moisture content L in the lower zone storage. The remaining amount of infiltrating moisture, G , is assumed to percolate deeper and recharge the groundwater storage.



Interflow

The interflow contribution, QIF , is assumed to be proportional to U and to vary linearly with the relative moisture content of the lower zone storage.

$$QIF = \begin{cases} (CKIF)^{-1} \frac{L/L_{max} - TIF}{1 - TIF} U & \text{for } L/L_{max} > TIF \\ 0 & \text{for } L/L_{max} \leq TIF \end{cases} \quad (7.3)$$

Where:

$CKIF$ Time constant for interflow

TIF Root zone threshold value for interflow ($0 \leq TIF \leq 1$)

Interflow and overland flow routing

The interflow is routed through two linear reservoirs in series with the same time constant CK_{12} . The overland flow routing is also based on the linear reservoir concept but with a variable time constant

$$CK = \begin{cases} CK_{12} & \text{for } OF < OF_{min} \\ CK_{12} \left(\frac{OF}{OF_{min}} \right)^{-\beta} & \text{for } OF \geq OF_{min} \end{cases} \quad (7.4)$$

Where:

OF Overland flow intensity (mm/hour)

OF_{min} Upper limit for linear routing (= 0.4 mm/hour),

β = 0.4

The constant $\beta = 0.4$ corresponds to using the Manning formula for modelling the overland flow. Equation (7.4) ensures in practice that the routing of real surface flow is kinematic, while subsurface flow being interpreted by NAM as overland flow (in catchments with no real surface flow component) is routed as a linear reservoir.



The reservoir time constants CK_1 and CK_2 taken equal to $CKOF$ in both reservoirs. ■



Groundwater recharge

The proportion of net excess rainfall, P_n , that does not run off as overland flow infiltrates into the lower zone storage representing the root zone. A portion, ΔL , of the amount of infiltration, $(P_n - OF)$, is assumed to increase the moisture content, L , in the lower zone storage. The remaining amount of infiltrating water, G , is assumed to percolate deeper and recharge the groundwater storage. The G and ΔL are calculated from:

$$G = \begin{cases} (P_n - QOF) \frac{L/L_{max} - TG}{1 - TG} & \text{for } L/L_{max} > TG \\ 0 & \text{for } L/L_{max} \leq TG \end{cases} \quad (7.5)$$

and

$$\Delta L = P_n - QOF - G$$

Where:

TG Root zone threshold value for groundwater recharge
($0 \leq TG \leq 1$)

Baseflow

The baseflow BF from the groundwater storage is calculated as the outflow from a linear reservoir with time constant CK_{BF} .

7.2.5 Extended groundwater components

Drainage to or from neighbouring catchments

Local geological conditions may cause part of the infiltrating water to drain to neighbouring catchments. In NAM this loss of water can be described by specifying the ratio of the groundwater catchment area to the topographical catchment area, C_{area} , with a value less than one. In this case the proportion $(1 - C_{area})$ of the recharge G is drained to neighbouring catchments. Similarly, water may be drained from neighbouring catchments, implying an increased groundwater recharge in the catchment ($C_{area} > 1$).

Lower groundwater storage

For a better description of the baseflow, an additional (lower) groundwater storage can be defined. In this case the upper groundwater storage provides the fast responding component of the baseflow, whereas the lower storage usually has a slower response. The recharge to the lower storage is given as



a proportion CQ_{LOW} of the total recharge G . The routing from the lower storage is described by a linear reservoir with time constant CK_{LOW} .

Shallow groundwater reservoir description

The groundwater level is calculated from a continuity consideration accounting for recharge G , capillary flux $CAFLUX$, net groundwater abstraction $GWPUMP$, and baseflow BF . The inclusion of capillary flux and groundwater pumping are optional. The groundwater storage can be treated in two different ways, either as a simple linear reservoir as described in Section Baseflow (p. 175) or as a shallow groundwater reservoir.

The shallow groundwater reservoir description is appropriate for lowland catchments with little topographical variation and the potential for water logging. The baseflow is given by

$$BF = \begin{cases} (GWL_{BF0} - GWL) S_Y (CK_{BF})^{-1} & \text{for } GWL \leq GWL_{BF0} \\ 0 & \text{for } GWL > GWL_{BF0} \end{cases} \quad (7.6)$$

Where:

S_Y Specific yield of the reservoir

GWL Groundwater table depth

GWL_{BF0} Maximum groundwater table depth, which causes baseflow

The parameter GWL_{BF0} can be interpreted as the distance between the average ground level of the catchment to the water level of the river. Due to the variation in the river water level throughout the year GWL_{BF0} can be given a significant annual variation.

Capillary flux

The capillary flux $CAFLUX$ of water from the groundwater to the lower zone storage is assumed to depend on the depth of the groundwater table below the ground surface, GWL , as well as on the relative moisture content, L/L_{max} , of the lower zone storage

$$CAFLUX = \sqrt{1 - L/L_{max}} \left(\frac{GWL}{GWL_{FL1}} \right)^{-\alpha} \text{ (mm/day)} \quad (7.7)$$

$$\alpha = 1,5 + 0,45 GWL_{FL1}$$



Where:

GWL_{FL1} Groundwater table depth at which the capillary flux is 1 mm/day when the lower zone storage is completely dry

Equation (7.7) provides a good fit to the theoretical relationship between the capillary flux, the depth to the water table and the soil moisture content proposed by Rijtema (1969) /38/.

The process is activated if a value of GWL_{FL1} different than zero is specified.

7.2.6 Snow module

Snow accumulation and melt are important hydrological processes in river basins where the snow pack acts as a storage in which precipitation is retained during the cold season and subsequently released as melt water during the warmer parts of the year.

The snow melt component of the runoff is incorporated as an integrated module within NAM. This component is optional and temperature data is only required if the snow routine is selected. Normally the precipitation enters directly into the surface storage. However, during cold periods precipitation is retained in the snow storage from which it is melted in warmer periods. Two different models can be applied; a simple lumped calculation or a more general approach that divides the catchment into a number of altitude zones with separate snow melt parameters, temperature and precipitation input for each zone.

Accumulation and melting of snow

Several investigations (e.g. /41/) have shown that the shift between precipitation in the form of rain and snow usually takes place when the air temperature is within a narrow interval close to 0 °C. In the snow module it is assumed that the precipitation falls as rain when the air temperature is above a certain base temperature level, T_0 , which can be specified by the user.

The snowmelt QS is calculated using a degree-day approach

$$QS = \begin{cases} C_{snow}(T - T_0) & \text{for } T > T_0 \\ 0 & \text{for } T \leq T_0 \end{cases} \quad (7.8)$$

Where:

C_{snow} Degree-day coefficient



The generated melt water is retained in the snow storage as liquid water until the total amount of liquid water exceeds the water retention capacity of the snow storage. The excess melt water P_S is routed to the NAM model where it contributes to the surface storage. The excess melt water contribution P_S to NAM is

$$P_S = \begin{cases} Q_{melt} & \text{for } WR \geq C_{wr}S_{snow} \\ 0 & \text{for } WR < C_{wr}S_{snow} \end{cases} \quad (7.9)$$

Where:

WR Water retention in the snow storage

C_{wr} Water retention coefficient

S_{snow} Snow storage



From MIKE+ interface, the Water retention coefficient C_{wr} is set to 8%. ■

The new snow storage is calculated by subtracting the excess melt water P_S from the snow storage.

The rain fraction is added as liquid water and is retained in the snow storage if the total liquid water content of the snow pack is below its water retaining capacity. When the air temperature is below T_0 , the liquid water content in the snow storage freezes with rate C_{snow} . Evaporation from the snow pack is neglected.

Altitude-distributed snowmelt model



This section is only available from MIKE 11 interface.

Introduction

In mountainous areas temperature, precipitation and snow cover often vary significantly within a single catchment. The runoff simulation for such areas can be improved by dividing the catchment into smaller zones and maintain individual snow storage calculations in each zone.

The altitude-distributed snow model calculates melt water in a number of altitude zones using the degree-day approach. Since in many cases the hydro-meteorological information from mountain basins is quite sparse, the module also includes facilities for distribution of the meteorological information with altitude.



Structure of the altitude-distributed snowmelt module

The snow melt module allows the user to define a number of altitude zones within a NAM catchment and adjust the snow melt parameters and the temperature and precipitation input to the model for each zone. The snow melt module maintains individual snow storages and calculates accumulation and melting of snow for each altitude zone. The simulated melt water from all zones is subsequently superposed and routed through the NAM model as illustrated in Figure 7.3. This implies that the same model parameters for infiltration, runoff and groundwater routing are applied for all altitude zones. Such an approach will be appropriate for the large majority of mountain catchments.

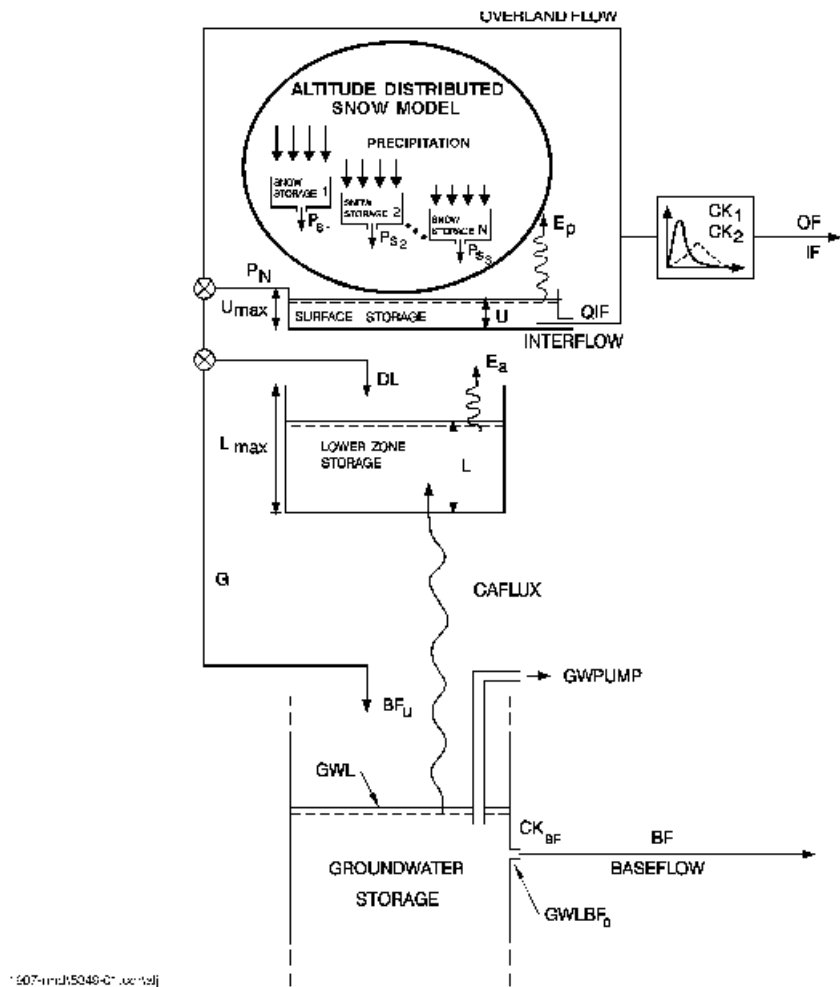

Figure 7.3 Structure of the NAM model with extended snow module

In special cases where differentiation is needed also in the other parameters the catchment in question can be divided into two or more sub-catchments. The total simulated discharge is then found by accumulating the simulated



discharge from the different sub-catchments using the combined catchment approach in the MIKE 11 RR editor.

In the altitude-distributed snow model, snow melting only takes place from the snow-covered part of each zone. When the water equivalent of the snow pack falls under a user-specified value (minimum storage for full coverage), the area coverage will be reduced linearly with the snow storage in the zone.

Snow will not necessarily melt on the location where it falls. Due to wind transport the snow accumulation at wind exposed sites may often be significantly smaller than at locations well sheltered against wind. Wind exposed conditions are often present at higher altitudes where vegetation is sparse and wind velocities generally high. Furthermore, for the higher parts of mountain ranges, steep slopes having a limited snow storage capacity will often dominate. Snow storage in excess of this capacity will at such locations generate avalanches which transport the snow to lower altitudes. Hence, some of the snow falling on wind exposed and/or steep highlands may not melt on the location but be deposited and melting at lower altitudes. To account for such re-distribution of snow and avoid unrealistic accumulation of snow in the cold upper zones a user specified upper limit of the snow storage in the individual zones has been introduced in the model. Snow storage exceeding this value will be transferred to the neighbouring lower zone.

Adjustment of temperature and precipitation to altitude zones

The altitude-distributed snow model operates with three meteorological reference time series; precipitation, temperature and potential evapotranspiration. In order to account for the large variations in precipitation and temperature with altitude the reference series can be adjusted for each altitude zone in two different ways:

- lapse rate corrections
- individual correction factors applied for each zone

The engine uses the individual factors for each zone. The lapse rate corrections are used to calculate the individual correction factors before starting the simulation.

Lapse rate corrections

The lapse rate correction approach is a very simple but powerful way of adjustment in which the temperature and the precipitation are assumed to vary linearly with the altitude. The only input data required are the average altitude of the various zones, a reference altitude of the time series, and the lapse rates. The temperature lapse rates, however, are known to be quite variable, ranging from high values under dry conditions to lower values under wet conditions. Hence, in the model it is possible to specify two different temperature lapse rates to be used during dry and wet weather conditions, respectively. The model applies the “wet” lapse rate during days with precipitation and the “dry” lapse rate during the rest of the time.



The temperature in each zone is adjusted by the following formula:

$$T_{zone} = \begin{cases} T_{ref} + (H_{zone} - H_{ref})\beta_{dry} & \text{for } P = 0 \\ T_{ref} + (H_{zone} - H_{ref})\beta_{wet} & \text{for } P > 0 \end{cases} \quad (7.10)$$

Where:

| | |
|---------------|--|
| T_{zone} | Temperature in the considered zone |
| T_{ref} | Temperature at the reference temperature station |
| H_{zone} | Average height in the zone |
| H_{ref} | Height at the reference temperature station |
| β_{dry} | Temperature lapse rate for dry conditions |
| β_{wet} | Temperature lapse rate for wet conditions |

The precipitation in each altitude zone is calculated from the precipitation at the reference station:

$$P_{zone} = P_{ref}(1 + (H_{zone} - H_{ref})\alpha) \quad (7.11)$$

Where:

| | |
|-----------|--|
| P_{ref} | Precipitation at the reference precipitation station |
| H_{ref} | Height at the reference precipitation series |
| α | Precipitation lapse rate |

Individual correction factors applied for each zone

In this case corrections have to be specified by the user for each altitude zone. This method requires more input but also offers a larger flexibility. The corrected meteorological series are calculated using the formulae:

$$T_{zone} = \begin{cases} T_{ref} + T_{cor, zone, dry} & \text{for } P = 0 \\ T_{ref} + T_{cor, zone, wet} & \text{for } P > 0 \end{cases} \quad (7.12)$$

$$P_{zone} = P_{ref}(1 + P_{cor, zone}) \quad (7.13)$$



Where:

| | |
|---------------------------|--|
| $T_{\text{cor,zone,wet}}$ | Actual temperature corrections for wet conditions |
| $P_{\text{cor,zone,dry}}$ | Actual temperature corrections for dry conditions, |
| $P_{\text{cor,zone}}$ | Relative precipitation correction |

If it is not possible to represent the meteorological conditions in the catchment by adjustment of one series only, the catchment may be divided into smaller sub-catchments in which one series will be representative. The discharges for the individual sub-catchments are then superposed using the combined catchment approach in the MIKE 11 RR editor. ■

Extended components



Seasonal variation of degree-day coefficient

The simple degree-day approach for calculating snow melt described by equation (7.8) can be extended by using a seasonal variation of the degree-day coefficient C_{snow} . This variation reflects in a conceptual way the seasonal variation of the incoming short wave radiation and the variation in the albedo of the snow surface during the snow season. The albedo is very high (about 0.8) for new, cold snow falling in the beginning of the accumulation season and then decreases with the age of the snow (to a minimum value of about 0.3 in the end of the season). ■



Radiation

The melting effects caused by the absorbed short wave radiation can be explicitly modelled. In this case an additional snow melting is calculated as

$$\Delta QS = C_{\text{rad}}R \quad (7.14)$$

Where:

| | |
|------------------|-------------------------------|
| C_{rad} | Radiation coefficient, |
| R | Incoming short wave radiation |

The total amount of snow melt is calculated as the sum of the snow melt rates given by Equations (7.8), (7.14), and (7.15) (optional), respectively. ■



Condensation of humid air and heat contribution from rainfall

The melting effects from condensation of humid air on the snow surface and the advective heat transferred to the snow pack by precipitation can be explicitly modelled. The effects are calculated as an additional snowmelt

$$\Delta QS = C_{\text{rain}}P(T - T_0) \quad (7.15)$$



Where:

| | |
|-------------------|-------------------------|
| C_{rain} | Degree-day coefficient, |
| P | Rainfall |

The total amount of snow melt is calculated as the sum of the snow melt rates given by (7.8), (7.14) (optional), and (7.15), respectively. ■

7.2.7 Irrigation module



This section concerns the irrigation module, which is only available from MIKE 11 interface.

Introduction

Minor irrigation schemes within a catchment will normally have negligible influence on the catchment hydrology, unless transfer of water over catchment boundaries is involved. Large schemes, however, may significantly affect the runoff and the groundwater recharge through local increases in evapotranspiration and infiltration as well as through operational and field losses.

The irrigation module of NAM may be applied to describe the effect of irrigation on the following aspects:

- The overall water balance of the catchment. This will be affected mainly by the increased evapotranspiration and by possible external water sources for irrigation.
- Local infiltration and groundwater recharge in irrigated areas.
- The distribution of catchment runoff amongst different runoff components (overland flow, interflow, baseflow). This may be influenced by the increased infiltration in irrigated areas as well as by local abstraction of irrigation water from groundwater or streams.

For each irrigation area within the catchment a NAM sub-catchment is defined with individual model parameters. The non-irrigated areas are modelled by defining a general NAM sub-catchment. The total simulated discharge is then found by accumulating the simulated discharge from the different sub-catchments using the combined catchment approach in the MIKE 11 RR editor.

Structure of the irrigation module

The structure of the irrigation module is illustrated in Figure 7.4.

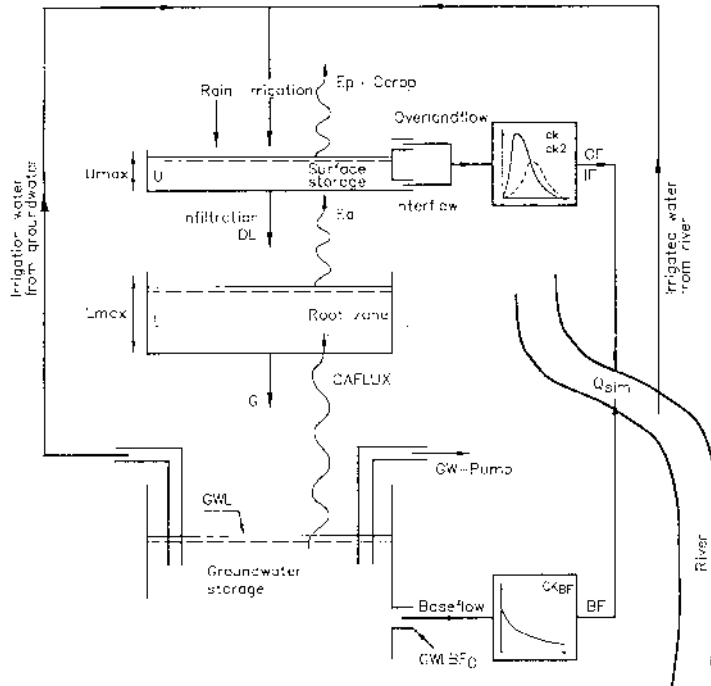

Figure 7.4 Structure of the NAM irrigation module.

Water supplied to the surface storage in irrigated areas will be a sum of precipitation P and irrigation water P_{ir} . The potential evapotranspiration may vary with crop type and the stage of growth. The irrigation module accounts for this by allowing the user to specify monthly varying crop coefficients C_{crop} for each irrigation area. The potential evapotranspiration for a specific crop is given by

$$E_{p,crop} = C_{crop}E_p \quad (7.16)$$

Where:

E_p Reference time series of potential evapotranspiration

Infiltration I is taken directly from the surface storage to the lower zone and groundwater storages and is calculated as a function of the moisture content in the lower zone L

$$I = \begin{cases} k0_{inf}L_{max}/L & \text{for } k0_{inf}L_{max}/L < U \\ U & \text{for } k0_{inf}L_{max}/L \geq U \end{cases} \quad (7.17)$$



Where:

$k_{0_{inf}}$ infiltration factor describing the infiltration rate at field capacity (i.e. $L = L_{max}$)

A portion G of the infiltration is assumed to percolate deeper and recharge the groundwater storage. This portion is, as in the general NAM model, calculated as a function of the conditions in the lower zone storage

$$G = \begin{cases} I \frac{L/L_{max} - TG}{1 - TG} & \text{for } L/L_{max} > TG \\ 0 & \text{for } L/L_{max} \leq TG \end{cases} \quad (7.18)$$

Where:

TG root zone threshold value for groundwater recharge

The remaining part ΔL is assumed to increase the moisture content in the lower zone

$$\Delta L = I - G \quad (7.19)$$

If the maximum surface storage U_{max} is exceeded, the general NAM model diverts the excess water into overland flow (QOF) and infiltration. In the irrigation module infiltration has been accounted for as described above, and hence the excess water is added directly to overland flow.

Irrigation water can be abstracted from three different sources. The amount of water taken from each source type is determined by specifying fixed percentages of P_{ir} for each source type:

- local groundwater (PC_{lgw})
- local river (PC_{lr})
- external river (PC_{extr})

The term “local” means within the actual NAM catchment. If irrigation water is abstracted from local groundwater, it will be subtracted from the groundwater storage and the groundwater level will then be reduced with the amount

$$\Delta GWL = \frac{\Delta t PC_{lgw} P_{ir}}{S_y} \quad (7.20)$$



Where:

S_Y Specific yield

Δt Time step used in the calculations

If the water is abstracted from a local river, it will be subtracted from the calculated runoff

$$\Delta Q_{sim} = \Delta t PC_{Ir} P_{ir} \quad (7.21)$$

If the water is imported from a river outside the NAM catchment (external), no subtractions are made.

A part of the water diverted for irrigation will be lost on its way to the fields. The losses may include evaporation and seepage from channels, illegal off-takes, and operational losses (i.e. water that is diverted to the irrigation area but is not being utilised). In the irrigation module, the user may specify percentages of the irrigation water P_{ir} that is lost, i.e.

- evaporation losses (PC_{evap})
- seepage losses (PC_{gw})
- operational losses contributing to overland flow (PC_{of})

The losses may vary in time on a monthly basis.

Due to the different losses the irrigation water is reduced with the amount

$$\Delta P_{ir} = P_{ir}(PC_{evap} + PC_{gw} + PC_{of}) \quad (7.22)$$

The operational losses yields an increase in the overland flow

$$\Delta OF = \Delta t PC_{of} P_{ir} \quad (7.23)$$

The seepage losses contributes to an increase in the groundwater level

$$\Delta GWL = \frac{\Delta t PC_{gw} P_{ir}}{S_Y} \quad (7.24)$$



7.2.8 Model parameters

This section provides a short description of the model parameters, their physical interpretation and importance along with suggestions for parameter adjustments in the calibration.

7.2.9 Surface and root zone parameters

Maximum water content in surface storage U_{max}

U_{max} [mm] defines the maximum water content in the surface storage. This storage is interpreted as including the water content in the interception storage (on vegetation), in surface depression storages, and in the uppermost few cm's of the ground. Typical values of U_{max} are in the range 10-20 mm.

One important characteristic of the model is that the surface storage must be at its maximum capacity, i.e. $U \geq U_{max}$ before any excess water, P_N , occurs. In dry periods, the amount of net rainfall that must occur before any overland flow occurs can be used to estimate U_{max} .

The default value is 10 mm.

Maximum water content in root zone storage L_{max}

L_{max} [mm] defines the maximum water content in the lower or root zone storage. L_{max} can be interpreted as the maximum soil moisture content in the root zone available for the vegetative transpiration. Ideally, L_{max} can then be estimated by multiplying the difference between field capacity and wilting point of the actual soil with the effective root depth. The difference between field capacity and wilting point is referred to as the available water holding capacity (AWHC). For estimation of AWHC, moisture contents for different soil types at pF-value 2.5, corresponding approximately to field capacity, and pF-value 4.2, corresponding to wilting point are shown in Table 7.2

It should be noted that L_{max} represents the average value for an entire catchment, i.e. an average value for the various soil types and root depths of the individual vegetation types. Hence, L_{max} cannot in practice be estimated from field data, but an expected interval can be defined.

Since the actual evapotranspiration is highly dependent on the water content of the surface and root zone storages, U_{max} and L_{max} are the primary parameters to be changed in order to adjust the water balance in the simulations. In the preliminary stages of the model calibration, it is recommended to fix the relation between U_{max} and L_{max} , leaving only one storage parameter to be estimated. As a rule, $U_{max} = 0.1L_{max}$ can be used unless special catchment characteristics or hydrograph behaviour indicate otherwise.

The default value is 100 mm.



Table 7.2 Moisture content in cm^3/cm^3 at (effective) saturation (θ_s) and at pF-values of 2.5($\theta_{2.5}$) and 4.2($\theta_{4.2}$), for eleven textural classes and from three sources: (1) Rawls et al. (1982), /35/; (2) Cosby et al. (1984), /12/; (3) Rijtema (1969), /38/

| Soil texture | θ_s | | | $\theta_{2.5}$ | | | $\theta_{4.2}$ | | |
|-----------------|------------|-------|-------------|----------------|-------|-------------|----------------|-------|-------------|
| | (1) | (2) | (3) | (1) | (2) | (3) | (1) | (2) | (3) |
| Sand | 0.417 | 0.339 | 0.350-0.395 | 0.091 | 0.086 | 0.021-0.140 | 0.033 | 0.021 | 0.012-0.042 |
| Loamy Sand | 0.401 | 0.421 | 0.301-0.470 | 0.125 | 0.148 | 0.131-0.328 | 0.055 | 0.059 | 0.060-0.105 |
| Sandy Loam | 0.412 | 0.434 | 0.504-0.463 | 0.207 | 0.225 | 0.169-0.249 | 0.094 | 0.099 | 0.061-0.087 |
| Loam | 0.434 | 0.439 | 0.503 | 0.270 | 0.289 | 0.272 | 0.117 | 0.137 | 0.098 |
| Silt Loam | 0.486 | 0.476 | 0.509 | 0.330 | 0.364 | 0.309 | 0.133 | 0.175 | 0.092 |
| Sandy Clay Loam | 0.330 | 0.404 | 0.432 | 0.255 | 0.254 | 0.303 | 0.148 | 0.142 | 0.180 |
| Clay Loam | 0.390 | 0.465 | 0.445 | 0.318 | 0.343 | 0.380 | 0.197 | 0.212 | 0.255 |
| Silty Clay Loam | 0.432 | 0.464 | 0.475 | 0.366 | 0.385 | 0.325 | 0.208 | 0.246 | 0.185 |
| Sandy Clay | 0.321 | 0.406 | - | 0.339 | 0.294 | - | 0.239 | 0.204 | - |
| Silty Clay | 0.423 | 0.468 | 0.507 | 0.387 | 0.376 | 0.435 | 0.250 | 0.258 | 0.257 |
| Clay | 0.385 | 0.468 | 0.453-0.540 | 0.396 | 0.397 | 0.328-0.484 | 0.272 | 0.283 | 0.215-0.321 |

Overland flow runoff coefficient CQOF

CQOF is a very important parameter, determining the extent to which excess rainfall runs off as overland flow and the magnitude of infiltration.

CQOF is dimensionless with values between 0 and 1. Physically, in a lumped manner, it reflects the infiltration and also to some extent the recharge conditions. Small values of CQOF are expected for a flat catchment having coarse, sandy soils and a large unsaturated zone, whereas large CQOF-values are expected for catchments having low, permeable soils such as clay or bare rocks. CQOF-values in the range 0.01-0.90 have been experienced.

It should be noted that during periods where the groundwater table is at the ground surface the model excludes the infiltration component, and hence CQOF becomes redundant.

The default value is 0.3.

Time constant for interflow CKIF

CKIF [hours] determines together with U_{max} the amount of interflow ($CKIF$)⁻¹ is the quantity of the surface water content U that is drained to interflow every hour). It is the dominant routing parameter of the interflow because $CKIF \gg CK_{12}$.

Physical interpretation of the interflow is difficult. Since interflow is seldom the dominant streamflow component, CKIF is not, in general, a very important parameter. Usually, CKIF-values are in the range 500-1000 hours.

The default value is 500 hours.

Time constant for routing interflow and overland flow CK_{12}

The time constant for routing interflow and overland flow CK_{12} [hours] determines the shape of hydrograph peaks. The value of CK_{12} depends on the



size of the catchment and how fast it responds to rainfall. Typical values are in the range 3-48 hours.

The time constant can be inferred from calibration on peak events. If the simulated peak discharges are too low or arriving too late, decreasing CK_{12} may correct this, and vice versa.



From the MIKE+ interface, CK_{12} are set equal to CK_{OF} . ■

Root zone threshold value for overland flow TOF

TOF is a threshold value for overland flow in the sense that no overland flow is generated if the relative moisture content of the lower zone storage, L/L_{max} , is less than TOF . The behaviour of the threshold value is illustrated in Figure 7.5. Similarly, the root zone threshold value for interflow TIF and recharge TG act as threshold values for generation of interflow and recharge, respectively.

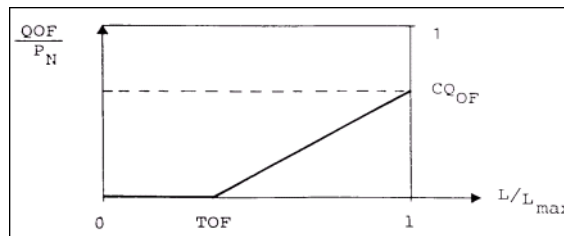

Figure 7.5 Generation of overland flow.

Physically, the three threshold values should reflect the degree of spatial variability in the catchment characteristics, so that a small homogeneous catchment is expected to have larger threshold values than a large heterogeneous catchment.

For catchments with alternating dry and wet periods, the threshold values determine the onset of the flow components in the periods where the root zone is being filled up. This can be used in model calibration. It should be noted that the threshold values have no importance in wet periods. The significance of the threshold value varies from catchment to catchment and is usually larger in semi-arid regions.

In areas with alternating dry and wet seasons, TOF can be estimated on the basis of situations where even very heavy rainfall does not give rise to the quick response of the overland flow component. The parameter has an impact only during the first, few weeks of the wet season. Values of TOF in the range 0-0.7 have been experienced.

The default value is 0.

Root zone threshold value for interflow TIF

The root zone threshold value for interflow has the same function for interflow as TOF has for the overland flow. It is usually not a very important parameter, and it can in most cases be given a value equal to zero.

7.2.10 Groundwater parameters

Baseflow time constant CK_{BF}

The time constant for baseflow, CK_{BF} [hours], determines the shape of the simulated hydrograph in dry periods. According to the linear reservoir description the discharge in such periods is given by an exponential decay. CK_{BF} can be estimated from hydrograph recession analysis. CK_{BF} -values in the range 500-5000 hours have been experienced.

If the recession analysis indicates that the shape of the hydrograph changes to a slower recession after a certain time, an additional (lower) groundwater storage can be added to improve the description of the baseflow.

The default value is 2000 hours.

Root zone threshold value for groundwater recharge TG

The root zone threshold value for recharge has the same effect on recharge as TOF has on the overland flow. It is an important parameter for simulating the rise of the groundwater table in the beginning of a wet season.

Recharge to lower groundwater storage CQ_{LOW}



In some cases the shape of the hydrograph recession changes to a slower recession after a certain period. To simulate this, a lower groundwater storage may be included. The parameter CQ_{LOW} determines the proportion of the recharge that percolates to the lower groundwater storage. CQ_{LOW} together with CK_{low} can be estimated from hydrograph recession analysis. ■

The default value is 1000 hours.

Time constant for routing lower baseflow CK_{low}



The baseflow from the lower groundwater storage is modelled using a linear reservoir with time constant CK_{low} [hours]. The time constant can be estimated from hydrograph recession analysis. Usually, CK_{low} is larger than CK_{BF} . ■

The default value is 10,000 hours.



Ratio of groundwater catchment to topographical catchment area C_{area}

Drainage to or from neighbouring catchments can be modelled by specifying a value of C_{area} different from 1. C_{area} specifies the amount of recharge G that is being drained. If $C_{area} < 1$, part of the recharge, $(1-C_{area})G$, is drained to another catchment, whereas for $C_{area} > 1$, the amount $(C_{area}-1)G$ is added to the catchment recharge.

The default value is 1.

Maximum groundwater depth causing baseflow GWL_{BF0}

The maximum depth to the groundwater table for which baseflow occurs, GWL_{BF0} [m], represents the outflow level of the groundwater reservoir given as the distance between the average ground level of the catchment and the minimum level of the river to which it drains. In low, flat areas the annual variation of this distance may be of importance and the facility to allow GWL_{BF0} to vary seasonally is provided in NAM.

GWL_{BF0} and the specific yield S_Y can be calibrated by comparing the simulated groundwater level with observations.

The default value is 10 metres.

Specific yield S_Y

Values of the specific yield for the groundwater storage may often be assessed from hydrological data e.g. pump tests. Alternatively, S_Y -values can be estimated from the literature for different soil types. Small values are found for clay (0.01-0.1) and high values for sand (0.1-0.3).

The default value is 0.1.

Groundwater depth for unit capillary flux GWL_{FL1}

GWL_{FL1} [m] is the depth to the groundwater table which yields an upward capillary flux of 1 mm/day when the moisture content of the upper soil layers is at wilting point, i.e. $L = 0$. This parameter will depend on the soil type, and values for 20 soil types according to Rijtema (1969) /38/ are listed in Table 7.3.



The default value is 0 metre.

Table 7.3 Depth to the groundwater table corresponding to a capillary flux of 1 mm/day for 20 soil types

| Soil Type | GWL_{FL1} [m] |
|-----------------------------------|-----------------|
| 1. Coarse sand | 0.5 |
| 2. Medium coarse sand | 0.6 |
| 3. Medium fine sand | 0.9 |
| 4. Fine sand | 1.5 |
| 5. Humus loamy medium coarse sand | 1.2 |
| 6. Light loamy medium coarse sand | 0.7 |
| 7. Loamy medium coarse sand | 0.5 |
| 8. Loamy fine sand | 1.7 |
| 9. Sandy loam | 0.7 |
| 10. Loess loam | 1.5 |
| 11. Fine sandy loam | 2.5 |
| 12. Silty loam | 2.8 |
| 13. Loam | 1.9 |
| 14. Sandy clay loam | 2.2 |
| 15. Silty Clay Loam | 1.8 |
| 16. Clayey Loam | 1.0 |
| 17. Light clay | 2.9 |
| 18. Basin clay | 0.4 |
| 19. Silty clay | 1.4 |
| 20. Peat | 0.6 |

Minimum groundwater depth for diverting recharge to surface GWL_{min}



Minimal depth of groundwater below surface, at which the groundwater recharge is diverted to the surface/overland flow. ■

This parameter is not available from the MIKE 11 user interface, therefore the default value of 0.00 metre will apply.



7.2.11 Snow module parameters

Degree-day coefficient C_{snow}

The snow melts at a rate defined by the degree-day coefficient C_{snow} [mm/°C/day]. A seasonal variation of C_{snow} can be defined in order to account for the seasonal variations of the incoming short wave radiation and the albedo of the snow surface. Typical values of C_{snow} are in the range 2-4 mm/°C/day.

The default value is 3 mm/°C/day.

Base temperature (snow/rain) T_0



The precipitation is assumed to fall as snow if the temperature is below the base temperature T_0 [°C]. For temperatures above T_0 the snow in the snow storage is melting. The base temperature is usually close to zero degrees Celsius. ■

Radiation coefficient C_{rad}



The radiation coefficient C_{rad} [m²/W/mm/day] determines the rate of snow melting caused by the absorbed short wave radiation. ■

Rainfall degree-day coefficient C_{rain}



The rainfall degree-day coefficient C_{rain} [mm/mm/°C/day] determines the rate of snow melting caused by condensation of humid air on the snow surface and the advective heat transferred to the snow pack by precipitation. ■

7.2.12 Irrigation module parameters

Infiltration factor KO_{inf}



KO_{inf} [mm/day] is the infiltration factor which, together with the moisture content in the upper and root zone storages, determines the amount of water infiltrating from the surface to the root zone and groundwater storage.

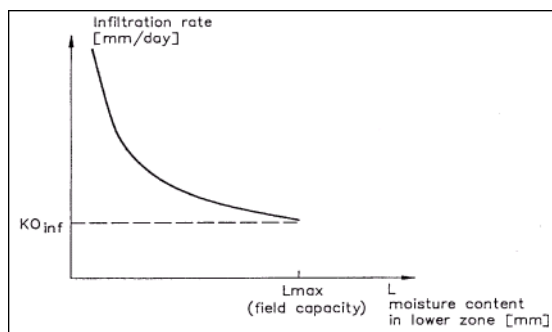

Figure 7.6 Infiltration rate as a function of the moisture content in the root zone.

In Figure 7.6 the infiltration rate is shown as a function of the moisture content in the root zone. KO_{inf} is strongly dependent on the soil type and is large for sandy soils and small for clayey soils.

When irrigation water is supplied, the root zone will often be close to saturation. Under such conditions the infiltration rate KO_{inf} may converge to the saturated hydraulic conductivity of the soil (K_s). As a guideline K_s -values for different soil types, as estimated by various authors, are presented in Table 7.4.

When the root zone is only partly saturated, the flow dynamics become very complicated and are not properly described in a lumped model like NAM. Furthermore, the soil preparation may have a significant influence on the soil hydraulic conductivity.

Crop coefficients and irrigation losses

The crop coefficients account for the fact that potential evapotranspiration is dependent of the crop type and the stage of growth. This is achieved by multiplying the input time series of potential evapotranspiration with the crop coefficient. For dry uncropped soils, the crop coefficient will tend to zero while well cropped fields reaching full growth potential could have crop coefficients greater than 1. Further information about how to estimate the crop coefficients is given in /35/. Monthly values of crop coefficients can be specified.

The monthly magnitude and distribution of losses to evaporation, seepage, and overland flow should correspond to the design values of the irrigation scheme unless observations have shown a different distribution.

Table 7.4 Values of saturated hydraulic conductivity K_s for eleven textural classes from six sources (1) Li et al. (1976), /23/; (2) Brakensiek (1979), /7/; (3) Brakensiek et al. (1981), /8/; (4) McCuen et al. (1981), /28/; (5) Cosby et al. (1984), /12/; (6) Rijtema (1969), /38/. The ratio between the largest and the smallest estimate has been calculated for columns 1-5 and 1-6, respectively



| Soil texture | K_s [cm/min] | | | | | | Ratio (max/min) | |
|-----------------|----------------|--------|-------|-------|---------------|------------|-----------------|---------|
| | (1) | (2) | (3) | (4) | (5) | (6) | Col 1-5 | Col 1-6 |
| Sand | 1.056 | 0.38 | 0.504 | 0.410 | 0.28 | 0.035-0.78 | 3.8 | 13 |
| Loamy Sand | 0.938 | 0.64 | 1.318 | 1.316 | 0.0003-0.080 | 0.018 | 16.5 | 4393 |
| Sandy Loam | 0.208 | 0.10 | 0.315 | 0.299 | 0.0083-0.031 | 0.0115 | 10.1 | 38 |
| Loam | 0.0417 | 0.019 | 0.109 | 0.100 | 0.020 | 0.0035 | 5.7 | 31 |
| Silt Loam | 0.0432 | 0.0085 | 0.027 | 0.027 | 0.0066 | 0.0045 | 6.5 | 9.6 |
| Sandy Clay Loam | 0.0378 | 0.026 | 0.082 | 0.079 | 0.026 | 0.0163 | 3.1 | 5 |
| Clay Loam | 0.0147 | 0.0054 | 0.064 | 0.061 | 0.015 | 0.0007 | 11.9 | 91 |
| Silty Clay Loam | 0.0102 | 0.020 | 0.019 | 0.018 | 0.012 | 0.0010 | 2.0 | 20 |
| Sandy Clay | 0.0130 | 0.0050 | - | 0.021 | 0.043 | - | 8.6 | 8.6 |
| Silty Clay | 0.0062 | 0.0065 | 0.039 | 0.030 | 0.008 | 0.0009 | 6.3 | 43 |
| Clay | 0.0077 | 0.0078 | 0.020 | 0.018 | 0.0002-0.0058 | 0.0024 | 3.4 | 100 |

7.2.13 Initial conditions



From the MIKE 11 interface, the initial conditions required by the NAM model consist of the initial water contents in the surface and root zone storages, together with initial values of overland flow, interflow, and baseflow. If a lower groundwater reservoir is specified, the initial baseflow from both the upper and the lower reservoir should be specified. ■



However from the MIKE+ interface, the water depth of surface and lower zone storage, values of interflow and overland flow and the groundwater depth at the start of the simulation are part of the initial conditions. The groundwater depth, GWL , is related to the NAM parameter GWL_{BF0} , defining the groundwater depth which generates a groundwater recharge of zero, e.g. a value of 9.5 m for GWL is suitable if the parameter GWL_{BF0} is set to 10.0 m, a standard value in NAM model. When changing the values of U_{max} and L_{max} , correspondingly the initiation values U_{init} and L_{init} have to be changed. ■

If the snow module is included, the initial value of the snow storage should be specified.

If a simulation commences at the end of a dry period, it is often sufficient to set all initial values to zero, except the water content in the root zone and the baseflow. The water content in the root zone should be about 10-30% of the capacity and the baseflow should be given a value close to the observed discharge.

Improved estimates of the initial conditions may be obtained from a previous simulation, covering several years, by noting the appropriate water contents of the root zone and baseflow at the same time of the year as the new simulation will start.

In general it is recommended to disregard the first 3-6 months of the NAM simulation in order to eliminate the influence of erroneous initial conditions.



7.2.14 Model calibration

In the NAM model the parameters and variables represent average values for the entire catchment. While in some cases a range of likely parameter values can be estimated, it is not possible, in general, to determine the values of the NAM parameters on the basis of the physiographic, climatic and soil physical characteristics of the catchment, since most of the parameters are of an empirical and conceptual nature. Thus, the final parameter estimation must be performed by calibration against time series of hydrological observations.

Calibration objectives and evaluation measures

The following objectives are usually considered in the model calibration:

1. A good agreement between the average simulated and observed catchment runoff (i.e. a good water balance)
2. A good overall agreement of the shape of the hydrograph
3. A good agreement of the peak flows with respect to timing, rate and volume
4. A good agreement for low flows

In this respect it is important to note that, in general, trade-offs exist between the different objectives. For instance, one may find a set of parameters that provide a very good simulation of peak flows but a poor simulation of low flows, and vice versa.

In the calibration process, the different calibration objectives 1-4 should be taken into account. If the objectives are of equal importance, one should seek to balance all the objectives, whereas in the case of priority to a certain objective this objective should be favoured.

For a general evaluation of the calibrated model, the simulated runoff is compared with discharge measurements. For individual calibration of the groundwater parameters, the simulated average groundwater level can be compared with groundwater level measurements in the catchments.

Both graphical and numerical performance measures should be applied in the calibration process. The graphical evaluation includes comparison of the simulated and observed hydrograph, and comparison of the simulated and observed accumulated runoff. The numerical performance measures include the overall water balance error (i.e. the difference between the average simulated and observed runoff), and a measure of the overall shape of the hydro-



graph based on the coefficient of determination or Nash-Sutcliffe coefficient /31/.

$$R^2 = 1 - \frac{\sum_{i=1}^N [Q_{obs,i} - Q_{sim,i}]^2}{\sum_{i=1}^N [Q_{obs,i} - \bar{Q}_{obs}]^2} \tag{7.25}$$

Where:

- $Q_{sim,i}$ Simulated discharge at time
- $Q_{obs,i}$ Corresponding observed discharge
- \bar{Q}_{obs} Average observed discharge
- $R^2 = 1$ Corresponds to a perfect match

An exact agreement between simulations and observations must, however, not be expected. The goodness-of-fit of the calibrated model is affected by different error sources, including

1. Errors in meteorological input data
2. Errors in recorded observations
3. Errors and simplifications inherent in the model structure
4. Errors due to the use of non-optimal parameter values

In model calibration only error source (4) should be minimised. In this respect it is important to distinguish between the different error sources since calibration of model parameters may compensate for errors in data and model structure. For catchments with a low quantity or quality of data, less accurate calibration results may have to be accepted.

Satisfactory calibrations over a full range of flows usually require continuous observations of runoff for a period of 3-5 years. Runoff series of a shorter duration, however, will also be useful for calibration, although they do not ensure an efficient calibration of the model. For a proper evaluation of the reliability and hydrological soundness of the calibrated model it is recommended to validate the model on data not used for model calibration (split-sample test). Some general aspects related to calibration and validation of hydrological models are described in Refsgaard and Storm (1996), /37/.



Manual calibration

The process of model calibration is normally done either manually or by using computer-based automatic procedures. In this section a manual calibration strategy for the NAM model is outlined. Application of an automatic optimisation routine for calibration of the basic NAM model is described in the subsequent section.

In manual calibration, a trial-and-error parameter adjustment is made until satisfactory results are obtained. It is recommended, especially for the less experienced users, to change only one parameter between each trial, so that the effect of the change can be easily discerned. The manual calibration strategy outlined below is based on the different rainfall-runoff process descriptions for calibration of the relevant model parameters, i.e. the parameters that mostly affect the considered process description (see also Section 7.2.8 Model parameters (p. 187)).

A calibration usually commences by adjusting the water balance in the system. The total evapotranspiration over a certain period should correspond to the accumulated net precipitation minus runoff. The evapotranspiration will increase when increasing the maximum water contents in the surface storage U_{max} and the root zone storage L_{max} , and vice versa.

The peak runoff events are caused by large quantities of overland flow. The peak volume can be adjusted by changing the overland flow runoff coefficient ($CQOF$), whereas the shape of the peak depends on the time constant used in the runoff routing (CK_{12}).

The amount of base flow is affected by the other runoff components; a decrease in overland flow or interflow will result in a higher baseflow, and vice versa. The shape of the baseflow recession is a function of the baseflow time constant ($CKBF$). If the baseflow recession changes to a slower recession after a certain time, a lower groundwater reservoir should be added, including calibration of CQ_{low} and CK_{low} .

Initially, the root zone threshold values TOF , TIF and TG can be set to zero. After a first round of calibration of the parameters U_{max} , L_{max} , $CQOF$, CK_{12} and $CKBF$, the threshold parameters can be adjusted for further refinement of the simulation results.

For individual calibration of the groundwater parameters GWL_{BF0} and S_Y , the simulated groundwater level is compared to observed groundwater levels. Inclusion of the shallow groundwater reservoir description is important in lowland areas, as found e.g. in swamps or river delta areas, where the groundwater table may reach the ground surface during the wet season.

The snow module parameters are calibrated against periods with snowmelt runoff.



Automatic calibration routine

For calibration of the basic NAM model, including the 9 model parameters listed in , an automatic optimization routine is available. The automatic calibration routine is based on a multi-objective optimization strategy in which the four different calibration objectives given above can be optimised simultaneously.

Multi-objective calibration measures

In automatic calibration, the calibration objectives have to be formulated as numerical goodness-of fit measures that are optimised automatically. For the four calibration objectives defined above the following numerical performance measures are used:

1. Agreement between the average simulated and observed catchment runoff: overall volume error.
2. Overall agreement of the shape of the hydrograph: overall root mean square error (RMSE).
3. Agreement of peak flows: average RMSE of peak flow events.
4. Agreement of low flows: average RMSE of low flow events.

Overall volume error

$$F_1(\theta) = \left| \frac{1}{N} \sum_{i=1}^N [Q_{obs,i} - Q_{sim,i}(\theta)] \right| \quad (7.26)$$

where

$Q_{obs,i}$ is the observed discharge at time i

$Q_{sim,i}$ is the simulated discharge at time i

θ is the set of model parameters to be calibrated

N is the number of time steps in the calibration period

Overall RMSE

$$F_2(\theta) = \left[\frac{1}{N} \sum_{i=1}^N [Q_{obs,i} - Q_{sim,i}(\theta)]^2 \right]^{1/2} \quad (7.27)$$

The coefficient of determination in Eq. (7.25) is a transformed and normalised measure of the overall RMSE (normalised with respect to the variance of the



observed hydrograph). Thus, minimisation of (7.27) corresponds to maximising R^2 .

Average RMSE of peak flow events

$$F_3(\theta) = \frac{1}{M_p} \sum_{j=1}^{M_p} \left[\frac{1}{n_j} \sum_{i=1}^{n_j} [Q_{obs,i} - Q_{sim,i}(\theta)]^2 \right]^{1/2} \quad (7.28)$$

where M_p is the number of peak flow events in the calibration period, and n_j is the number of time steps in event no. j . Peak flow events are defined as periods where the observed discharge is above a given (user-specified) threshold level.

Average RMSE of low flow events

$$F_3(\theta) = \frac{1}{M_l} \sum_{j=1}^{M_l} \left[\frac{1}{n_j} \sum_{i=1}^{n_j} [Q_{obs,i} - Q_{sim,i}(\theta)]^2 \right]^{1/2} \quad (7.29)$$

where M_l is the number of low flow events in the calibration period. Low flow events are defined as periods where the observed discharge is below a given (user-specified) threshold level.

Optimization algorithm

The multi-objective optimization problem can be formulated as follows

$$\min \{ F_1(\theta), F_2(\theta), F_3(\theta), F_4(\theta) \}, \theta \in \Theta \quad (7.30)$$

The optimization problem is said to be constrained in the sense that θ is restricted to the feasible parameter space Θ . The parameter space is defined as a hypercube by specifying lower and upper limits on each parameter. These limits should be chosen according to physical and mathematical constraints in the model and from modelling experiences.

The solution of (7.30) will not, in general, be a single unique set of parameters but will consist of the so-called Pareto set of solutions (non-dominated solutions), according to various trade-offs between the different objectives. The concept of Pareto optimality implies that the entire parameter space Θ can be divided into “good” (Pareto optimal) and “bad” solutions, and none of the “good” solutions can be said to be “better” than any of the other “good” solutions. A member of the Pareto set will be better than any other member with respect to some of the objectives, but because of the trade-off between the different objectives it will not be better with respect to other objectives.

In practical applications, the entire Pareto set may be too expensive to calculate, and one is only interested in part of the Pareto optimal solutions. To estimate only a single point of the Pareto front a single-objective optimization



problem is defined that aggregates the different objective functions $F_1(\theta) - F_4(\theta)$. The applied aggregate measure is the Euclidian distance

$$F_{agg}(\theta) = [(F_1(\theta) + A_1)^2 + (F_2(\theta) + A_2)^2 + (F_3(\theta) + A_3)^2 + (F_4(\theta) + A_4)^2]^{1/2} \quad (7.31)$$

where A_i are transformation constants. A balanced aggregated measure is defined by assigning transformation constants in (7.31) such that the different objectives have equal weight in the optimization. The transformation constants are automatically calculated based on the initially generated population of parameter sets in the optimization loop (/25/).

The optimal parameter set is found by minimising (7.31) with respect to θ . Optimization is performed automatically using the shuffled complex evolution (SCE) algorithm (/15/). The SCE method is a global search method in the sense that it is especially designed for locating the global optimum of the objective function and not being trapped in local optima. A detailed description of the algorithm is given in /15/. Implementation and testing of the algorithm for automatic calibration of the NAM model is described in /25/.

User specifications

Specifications for the NAM auto-calibration module include:

- Calibration parameters
- Range of calibration parameters
- Objective functions
- Stopping criterion

Calibration parameters

The automatic calibration routine includes the 9 model parameters shown in . The user specifies the subset of these parameters that should be calibrated automatically.

Range of calibration parameters

For the subset of NAM parameters to be calibrated automatically the user specifies the hypercube search space, i.e. lower and upper bounds on each parameter. The range of the different parameters should reflect the prior knowledge of experienced values for the type of catchment being considered. Default limits based on physical and mathematical model constraints and



experienced values for a range of different catchments are provided in Table 7.5.

Table 7.5 Calibration parameters and default hypercube search space

| Parameter | Unit | Lower bound | Upper bound |
|------------|---------|-------------|-------------|
| U_{\max} | [mm] | 5 | 35 |
| L_{\max} | [mm] | 50 | 400 |
| CQOF | [-] | 0 | 1 |
| CKIF | [hours] | 200 | 2000 |
| CK_{12} | [hours] | 3 | 72 |
| TOF | [-] | 0 | 0.9 |
| TIF | [-] | 0 | 0.9 |
| TG | [-] | 0 | 0.9 |
| CK_{BF} | [hours] | 500 | 5000 |

Objective functions

The user can specify any combination of the 4 objective functions: (1) overall water balance error, (2) overall RMSE, (3) peak flow RMSE, and (4) low flow RMSE. For the peak and low flow RMSE the user should specify the threshold levels for defining peak and low flow events, respectively.

The choice of objective functions should reflect the objective of the model simulation. For general hydrological studies, the overall water balance error and overall RMSE is normally applied. If focus of the study is on high or low flows, the peak or low flow RMSE should be included. It is not advised to use only the water balance error for optimisation, since this may provide an unrealistic model calibration.

Stopping criterion

The stopping criterion for the optimisation algorithm is the maximum number of model evaluations. The appropriate number of model evaluations depends primarily on the number of calibration parameters and the complexity of the model (interaction between model parameters). A large number of model evaluations are, in general, needed for a complex model with many parameters. This requirement should be balanced against the computing time. For a model calibration that includes all 9 parameters, a maximum number of model evaluations in the range 1000-2000 normally ensures an efficient calibration.

Besides the user-defined stopping criterion, the optimisation algorithm includes a parameter convergence criterion. In this case the optimisation



algorithm stops if the entire population of parameter sets in an optimisation loop have converged into the same parameter values.

7.3 Time-Area Surface Runoff Model

7.3.1 Concept

In the Time-Area surface rainfall-runoff method the amount of runoff is controlled by the initial loss, the size of the contributing area and by a continuous hydrological loss. Moreover a snow storage may also be added to the computation.

The shape of the runoff hydrograph is controlled by the concentration time and by the time-area (T-A) curve. These two parameters represent a conceptual description of the catchment reaction speed and the catchment shape.

7.3.2 Input data

Model specific data

Impervious area [%] represents the fraction of the catchment area considered to contribute to the runoff.

Hydrological parameters

Initial Loss [m] defines the precipitation depth required to start the surface runoff. This is a one-off loss, comprising the wetting and filling of catchment depressions.

The default value is $6.00 \cdot 10^{-4}$ m.

Hydrological Reduction [-] is a runoff reduction factor accounting for water losses caused by e.g. evapo-transpiration, imperfect imperviousness, etc. on the contributing area.

The default value is 0.90.

Time/Area Curve accounts for the shape of the catchment layout, determines the choice of the available T/A curve to be used in the computations.

Three predefined types of the T/A curves are available:

1. rectangular catchment
2. divergent catchment



3. convergent catchment

Table 7.6 Predefined types of T/A curves

| Curve type 1 | | Curve type 2 | | Curve type 3 | |
|--------------|----------|--------------|----------|--------------|----------|
| Time [-] | Area [-] | Time [-] | Area [-] | Time [-] | Area [-] |
| 0 | 0 | 0 | 0 | 0 | 0 |
| 1 | 1 | 0.1 | 0.12 | 0.1 | 0.01 |
| | | 0.2 | 0.28 | 0.2 | 0.04 |
| | | 0.3 | 0.47 | 0.3 | 0.08 |
| | | 0.4 | 0.61 | 0.4 | 0.15 |
| | | 0.5 | 0.72 | 0.5 | 0.24 |
| | | 0.6 | 0.8 | 0.6 | 0.35 |
| | | 0.7 | 0.87 | 0.7 | 0.47 |
| | | 0.8 | 0.93 | 0.8 | 0.62 |
| | | 0.9 | 0.98 | 0.9 | 0.8 |
| | | 1 | 1 | 1 | 1 |



The user-defined T/A curve can be specified, thus allowing correct description of irregular catchments. ■

The default T/A type is a pre-computed curve type 1.

From the MIKE 11 interface it is not possible to enter a user-defined T/A curve. The choice can only be made between one of the three predefined T/A curves. ■



Time/Area Coefficient [-] is used in a formula introduced in order to cover curve shapes “in between” the three standard ones (and outside). The formula has been suggested by Nittaya Wangwongwiroj at AIT. The curves “in between” are specified by giving the Time Area Coefficient.

$$\begin{aligned}
 (y = 1 - x)^{\frac{1}{a}} & \text{ for } 0 < a < 1 \\
 (y = x)^a & \text{ for } 1 \leq a
 \end{aligned}
 \tag{7.32}$$

Where:

y Accumulated dimensionless area

x Dimensionless concentration time

a Time area curve coefficient



The predefined curves 1, 2, and 3 as described above respectively correspond to a coefficient of 1, 0.5 and 2. Below is seen a plot of the curves.

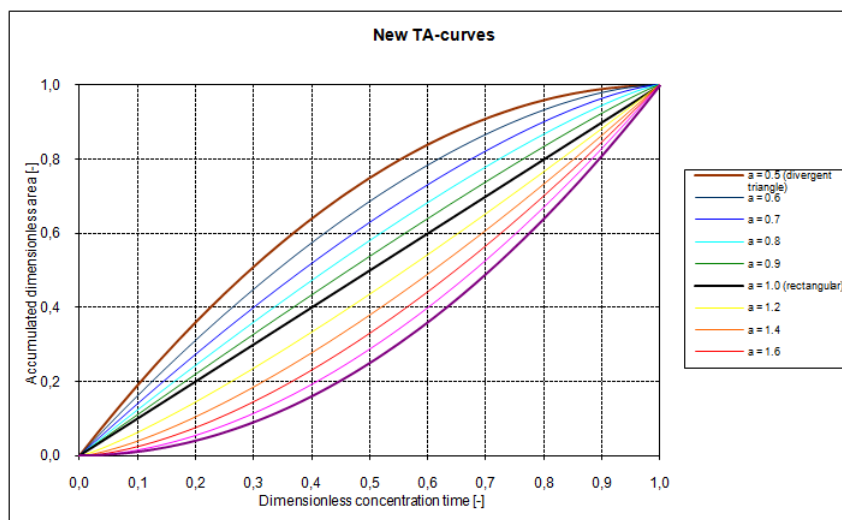

Figure 7.7 Example of T/A curves

n



The Time Area coefficient method is not available for the MIKE 11 interface.

Concentration Time [s] defines the time required for the flow of water from the most distant part of the catchment to the point of outflow.

The default value is 420 seconds.

Loss Recovery Rate [m/s] defines the rate to recover the initial loss during dry periods. Instead of this constant rate, an evaporation time series can be provided.

The default value is $5 \cdot 10^{-5}$ m/h.

Snow melt coefficient [m/°C/s] defines the rate of snow melting when temperature exceeds zero degrees Celsius.

7.3.3 Runoff computation

Snow storage computation

Snow can accumulate when the temperature is inferior or equal to zero degrees Celsius ($T \leq 0^\circ\text{C}$). During warmer periods, when temperature exceeds zero degrees Celsius ($T > 0^\circ\text{C}$), the snow storage melts at a rate



given by the **snow melt coefficient**. The snow storage computation will be performed only if a temperature time series is provided for the catchment.

During storing periods, or $T \leq 0^\circ\text{C}$ the snow will accumulate without limit. If the temperature is below zero degrees Celsius, it is assumed that the entire rainfall will be stored as snow.

During melting periods, or $T > 0^\circ\text{C}$ the snow will melt and therefore contributes to the surface runoff at rate given by the snow melt coefficient.

The snow module is the first process occurring after rainfall, therefore all other losses will be computed afterwards.

Effective precipitation computation

The simulated hydrologic processes account for specific losses. The runoff starts after the rain depth has exceeded the specified initial loss for the catchment. The remaining precipitation is called **effective precipitation**, defined generally as:

$$I_{\text{eff}}(t) = \begin{cases} I(t) - I_w(t) & \text{for } I(t) \geq I_w(t) \\ 0 & \text{for } I(t) < I_w(t) \end{cases} \quad (7.33)$$

Where:

$I_{\text{eff}}(t)$ Effective precipitation at time t

$I(t)$ Actual precipitation at time t

$I_w(t)$ Wetting loss at time t

The actual precipitation, $I(t)$, is assumed to be uniformly distributed over the individual catchments. Otherwise, it may vary as a random time function.

The wetting, $I_w(t)$, is a discontinuous loss, also called initial loss. When the precipitation starts, a part of the precipitation is used for wetting of the surface if the surface is initially dry. When the surface is wet, the wetting loss, I_w , is set to zero. This is summarised in the following expression:

$$I_w(t) = \begin{cases} I(t) & \text{for } y(t) < y_w \\ 0 & \text{for } (I(t) = 0) \text{ OR } (y(t) \geq y_w) \end{cases} \quad (7.34)$$



Where:

$I(t)$ Actual precipitation at time t

$I_w(t)$ Wetting loss at time t

y_w Wetting depth

$I(t)$ Accumulated depth at time t

Surface runoff routing computation

The continuous runoff process is discretised in time by the computational time step Δt . The assumption of the constant runoff velocity implies the spatial discretisation of the catchment surface to a number of cells in a form of concentric circles with a centre point at the point of outflow. The number of cells being equals to:

$$n = \frac{t_c}{\Delta t} \quad (7.35)$$

Where:

t_c concentration time [s]

Δt **simulation time step [s]**

The 1D engine calculates the area of each cell on the basis of the specified time-area curve or coefficient. The total area of all cells is equal to the specified impervious area.

A time-area curve characterises the shape of the catchment, relating the flow time i.e. concentric distance from the outflow point and the corresponding catchment sub-area. Irregularly shaped catchments can be more precisely described by the user-specified T/A curves or coefficient.

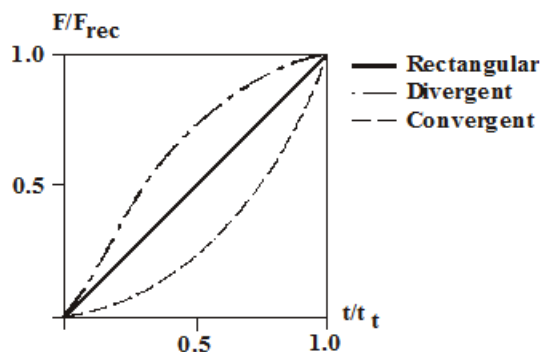
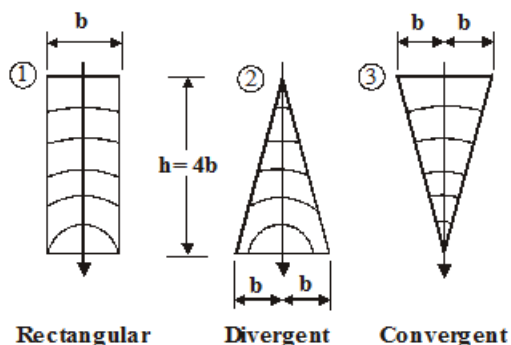

Figure 7.8 The three predefined time/area curves available

The runoff stops when the accumulated rain depth on the whole catchment surface regresses below the specified initial loss for the catchment.

At every time step after the start of the runoff, the accumulated volume from a certain cell is moved to the downstream direction. Thus, the actual volume in the cell is calculated as a continuity balance between the inflow from the upstream cell, the current rainfall (multiplied with the cell area) and the outflow to the downstream cell. The outflow from the most downstream cell is actually the resulting surface runoff hydrograph.

To account for the specified hydrological reduction, the runoff from the impervious surface is reduced by the catchments hydrological reduction factor.

7.3.4 Multiple-event simulations

If the Time Area Surface Runoff Model is used for a continuous simulation of multiple rainfall, a special solution can be applied for the simulation of dry periods between the consecutive events. The solution accounts for the loss of water caused by drying out of the initial loss (representing wetting and surface storage), i.e. allowing the occurrence of the initial loss at the beginning of each simulated event, in accordance with reality.



In this context, start of a dry period is defined if two conditions are fulfilled simultaneously:

- No rainfall: all connected rain gauges show no rain.
- No runoff: the runoff has fallen to zero from all catchments included in the simulation.

At the start of a dry period, the initial loss storage would be fully or partially filled up, the latter being the only case for small events of the total depth smaller than the initial loss storage depth. Recovery of the initial loss capacity, i.e. the process of surface drying is simulated as a constant “decay” rate, which replaces the actual evaporation. As a consequence of the recovery process, the initial loss storage would be fully or partially emptied, which depends on the actually applied loss recovery rate and the duration of the dry period.

The evaporation rate can be given as Initial Loss Rate or as an evaporation time series. If the actual evaporation is not explicitly specified in the simulation (i.e. Evaporation process activated – see INI file parameters – and evaporation time series specified), only a decay rate will be applied during dry periods.

The recovery process is only activated during dry periods, i.e. the evaporative action during rain events is neglected.

7.4 Kinematic Wave Surface Runoff Model

7.4.1 Concept

The concept of this surface runoff computation is founded on the kinematic wave computation. The surface runoff is computed as flow in an open channel, taking in to account the gravitational and friction forces only. The amount that runs off is controlled by the various hydrological losses and the size of the actually contributing area.

The shape of the runoff hydrograph is controlled by the catchment parameters length, slope and roughness of the catchment surface. These parameters form a base for the kinematic wave computation using the Manning equation.



The catchment is divided into five sub-catchments that have different permeability properties of the surface. The five surface types are:

Table 7.7 Permeability properties of sub-catchment surfaces

| Permeability | Surface type |
|--------------|--------------------------|
| Impervious | Steep Flat |
| Pervious | Small Medium Large |

Only relevant processes are modelled on each surface type. The model applies different hydrological parameters for each of the surface types. The total runoff is computed as the sum of these sub-catchments.

7.4.2 Input data

Model specific data

Length [m] is defined by the catchment shape, as the flow channel. The model assumes a prismatic flow channel with rectangular cross section. The channel bottom width is computed from catchment area and length.

The default value is 10 m.

Slope [-] is the average slope of the catchment surface, used for the runoff computation according to Manning equation.

The default value is 1.

Surface type areas [-] represent the fractions of the catchment surface belonging to each surface types.

The default value depends on the surface type (see Table 7.8).

Hydrological Parameters

Wetting loss [m] is a one-off loss, accounting for wetting of the catchment surface.

The default value for all surface types is $5.00E10^{-5}$ m.

Storage loss [m] is a one-off loss, which defines the precipitation depth required for filling the depressions on the catchment surface prior to occurrence of runoff.



The default value depends on the surface type (see Table 7.8)

Start infiltration rate [m/s] defines the maximum rate of infiltration (Horton) for the specific surface type.

The default value depends on the surface type (see Table 7.8).

End infiltration rate [m/s] defines the minimum rate of infiltration (Horton) for the specific surface type.

The default value depends on the surface type (see Table 7.8).

Wet Horton Exponent [s⁻¹] is time factor “characteristic soil parameter”. It determines the dynamics of the infiltration capacity rate reduction over time during wet period. The actual infiltration capacity is made dependent of time since the rainfall start only.

The default value depends on the surface type (see Table 7.8).

Dry Horton Exponent [s⁻¹] is a time factor used in the “inverse Horton's equation”, defining the rate of the soil infiltration capacity recovery after a rainfall, i.e. in a drying period.

The default value depends on the surface type (see Table 7.8).

Manning's number [m^{1/3}s⁻¹] describes roughness of the catchment surface, used in hydraulic routing of the runoff (Manning's formula).

The default values depend on the catchment surface category (see Table 7.8).

Table 7.8 Default hydrological parameters for Kinematic wave surface runoff model

| Default values for hydrological parameters | | | | | |
|--|------------|---------|----------|---------|---------|
| Parameter | Impervious | | Pervious | | |
| | Steep | Flat | Small | Medium | Large |
| Area fraction (-) | 0 | 0.4 | 0 | 0 | 0.6 |
| Wetting (m) | 5.00E-5 | 5.00E-5 | 5.00E-5 | 5.00E-5 | 5.00E-5 |
| Storage (m) | - | 6.00E-4 | 1.00E-3 | 1.00E-3 | 2.00E-3 |
| Start inf. rate (m/s) | - | - | 8.00E-7 | 8.00E-7 | 2.00E-5 |
| End inf. rate (m/s) | - | - | 8.00E-7 | 8.00E-7 | 3.00E-6 |
| Wet exponent (s ⁻¹) | - | - | 0 | 0 | 1.50E-3 |

Table 7.8 Default hydrological parameters for Kinematic wave surface runoff model

| Default values for hydrological parameters | | | | | |
|--|----|----|----|----|---------|
| Dry exponent (s^{-1}) | - | - | 0 | 0 | 3.00E-5 |
| Manning ($m^{1/3}s^{-1}$) | 80 | 70 | 30 | 30 | 12 |

7.4.3 Runoff computations

The model computations are based on the volume continuity and the kinematic wave equations.

The first step is the calculation of the snow storage if relevant, then the effective precipitation intensity. The effective precipitation intensity is the precipitation which contributes to the surface runoff, i.e. when the losses have been taken into account (evaporation, infiltration...)

Next, the hydraulic routing based on the kinematic wave formula (Manning) and volume continuity is applied. The sketch with schematics of the model computation is shown in Figure 7.9.

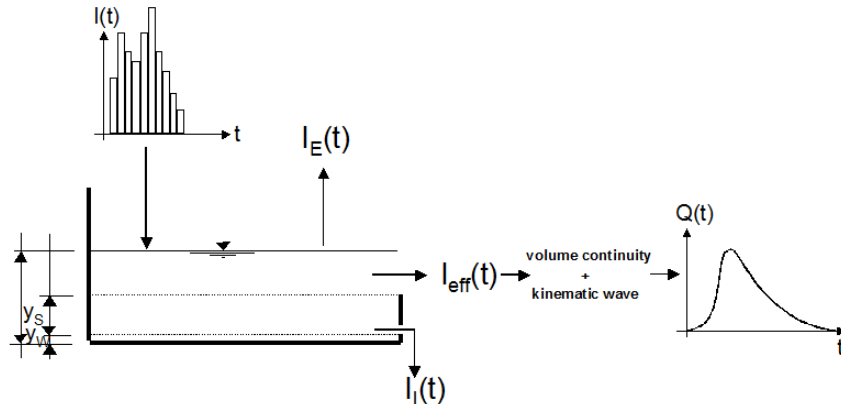

Figure 7.9 The simulated processes in Kinematic wave surface runoff model

Snow storage computation

Snow can accumulate when the temperature is inferior or equal to zero degrees Celsius ($T \leq 0^{\circ}C$). During warmer periods, when temperature exceeds zero degrees Celsius ($T > 0^{\circ}C$), the snow storage melts at a rate given by the **snow melt coefficient**. The snow storage computation will be performed only if a temperature time series is provided for the catchment.



During storing periods, or $T \leq 0^\circ\text{C}$ the snow will accumulate without limit. If the temperature is below zero degrees Celsius, it is assumed that the entire rainfall will be stored as snow.

During melting periods, or $T > 0^\circ\text{C}$ the snow will melt and therefore contributes to the surface runoff at rate given by the snow melt coefficient.

The snow module is the first process occurring after rainfall, therefore all other losses will be computed afterwards.

Effective precipitation computation

The simulated hydrologic processes account for various losses calculated - evaporation, wetting, infiltration and surface storage - according to the conventions and equations presented below. The remaining precipitation is called **effective precipitation**, defined generally as:

$$I_{\text{eff}}(t) = I(t) - I_E(t) - I_W(t) - I_I(t) - I_S(t) \quad , \quad I_{\text{eff}} \geq 0 \quad (7.36)$$

Where:

$I(t)$ Actual precipitation at time t

$I_E(t)$ Evaporation loss at time t . It should be noted that the evaporation loss for the catchment is accounted only if an evaporation time series is provided

$I_W(t)$ Wetting loss at time t

$I_I(t)$ Infiltration loss at time t

$I_S(t)$ Surface Storage loss at time t

The individual terms in the loss equation are fundamentally different, as some terms are continuous where others are discontinuous. If the calculated loss is negative, it is set to zero. The losses have a dimension of velocity [LT⁻¹].

The actual precipitation, $I(t)$, is assumed to be uniformly distributed over the individual catchments. Otherwise, it may vary as a random time function.

The evaporation, $I_E(t)$, is a continuous loss that is normally of less significance for single event simulations. However, on a long-term basis, evaporation accounts for a significant part of hydrological losses. If included in the



computation, the evaporation is the first part subtracted from the actual precipitation, according to the following:

$$I_E(t) = \begin{cases} I_E(t) \text{ for } (I(t) \geq I_{PE}(t)) \text{ OR } (y(t) > 0) \\ I(t) \text{ for } (I(t) < I_{PE}(t)) \text{ AND } (y(t) = 0) \end{cases} \quad (7.37)$$

Where:

$I(t)$ Actual precipitation at time t

$I_E(t)$ Evaporation loss at time t

$I_{PE}(t)$ Potential evaporation at time t

$y(t)$ Accumulated depth at time t

If the actual evaporation is not explicitly specified in the simulation (i.e. Evaporation process activated – see INI file parameters – and evaporation time series specified), only a decay rate will be applied during dry periods.

The wetting, $I_W(t)$, is a discontinuous loss. When the precipitation starts, a part of the precipitation is used for wetting of the surface if the surface is initially dry. The model assumes that the precipitation remaining after subtraction of the evaporation loss is used for wetting of the catchment surface. When the surface is wet, the wetting loss, I_W , is set to zero. This is summarised in the following expression:

$$I_W(t) = \begin{cases} I(t) - I_E(t) \text{ for } y(t) < y_w \\ 0 \text{ for } (I(t) \leq I_E(t)) \text{ OR } (y(t) \geq y_w) \end{cases} \quad (7.38)$$

Where:

$I(t)$ Actual precipitation at time t

$I_E(t)$ Evaporation loss at time t

$I_W(t)$ Wetting loss at time t

y_w Wetting depth

$y(t)$ Accumulated depth at time t

The infiltration, $I_I(t)$, is the water loss to the lower storage caused by the porosity of the catchment surface. It is assumed that the infiltration starts



when the wetting of the surface has been completed. The infiltration loss is calculated according to the following relation:

$$I_f(t) = \begin{cases} I_H(t) & \text{for } (I(t) - I_E(t) - I_W(t)) \geq I_H(t) \text{ \& } (y(t) \geq y_W) \\ I(t) - I_E(t) - I_W(t) & \text{for } (I(t) - I_E(t) - I_W(t)) < I_H(t) \\ 0 & \text{for } y(t) < y_W \end{cases} \quad (7.39)$$

Where:

| | |
|----------|-----------------------------------|
| $I_f(t)$ | Infiltration loss at time t |
| $I_H(t)$ | Horton's infiltration at time t |
| y_W | Wetting depth |
| $y(t)$ | Accumulated depth at time t |

The infiltration is a complex phenomenon, dependent on the soil porosity, moisture content, groundwater level, surface conditions, storage capacity, etc. The model calculates the infiltration loss capacity using the well-known Horton's equation, per default in its original form:

$$I_H(t) = I_{Imin} + (I_{Imax} - I_{Imin}) \cdot e^{-k_a \cdot t} \quad (7.40)$$

Where:

| | |
|------------|--|
| $I_H(t)$ | Infiltration loss calculated according to Horton |
| I_{Imax} | Maximum infiltration capacity (after a long dry period) |
| I_{Imin} | Minimum infiltration capacity (at full saturation) |
| t | Time since the start of the storm |
| k_a | Time factor (characteristic soil parameter) for wetting conditions |



The Horton's equation in its original form (7.40) yields in realistic results only if applied to events for which the rainfall intensity always exceeds the infiltration capacity. However, typical values for infiltration capacity parameters I_{Imax} and I_{Imin} are often greater than typical rainfall intensities. Thus, when Equation (7.40) is used, with infiltration capacity I_H being the function of time only, I_H will decrease even if rainfall intensities are very small. In other words, this results in a reduction in infiltration capacity regardless of the actual amount of



water entering the soil. This problem is solved by implementing the integrated form of the Equation (7.40):

$$I_{ICUM}(t_P) = \int_0^{t_P} I_H dt = I_{Imin} \cdot t_P + \frac{I_{Imax} - I_{Imin}}{k_a} \cdot (1 - e^{-k_a t_P}) \quad (7.41)$$

Where:

$I_{CUM}(t_p)$ A cumulative infiltration (m) at time t_p , i.e. the area under the Horton's curve

This assumes that the actual infiltration has been equal to the infiltration capacity at any time within the period $0 \rightarrow t$. Since this is only the case for rainfall intensities higher than the infiltration capacity, this needs to be corrected as:

$$I_{CUM}(t) = \int_0^t I_I dt \quad (7.42)$$

i.e. the cumulative infiltration at the elapsed time t is calculated using the actually occurred infiltration.

At any elapsed time t , the two equations (7.41) and (7.42) can be used to determine the “equivalent” time t_p . This is done iteratively, since equation (7.41) cannot be solved explicitly for t_p .

The time t_p on cumulative Horton's curve will always be less or equal than the actually elapsed time, implying that the available infiltration capacity at time t_p will be greater than or equal to that given by the equation (7.40). By these means, the infiltration capacity has been made a function of actual water infiltrated and not just a function of time.

Per default, the program is set to “standard” Horton's equation. Application of a “standard” Horton's equation (7.40) or its integrated form (Equations (7.41) and (7.42)) is controlled par the parameter Integrated Horton. ■



MIKE 11 note: the integrated Horton form of the equation is not available from MIKE 11 interface, so only its “normal” form can be used. ■

In the dry period following the rainfall, the infiltration capacity is gradually recovered to the initial value, using an inverse form of the Horton's equation:

$$I_H(t) = I_{IT} + (I_{Imax} - Q_{IT}) \cdot e^{-1/k_h t} \quad (7.43)$$



Where:

| | |
|------------|--|
| $I_H(t)$ | Infiltration loss capacity calculated according to Horton |
| I_{Imax} | Maximum infiltration capacity (after a long dry period) |
| I_{IT} | Infiltration capacity at the threshold between the wetting and drying period |
| t | Time since the start of the recovery process |
| k_h | Dry Horton Exponent, the time factor (characteristic soil parameter) for drying conditions |

The surface storage, $I_S(t)$, is the loss due to filling the depressions and holes in the terrain. The model begins with the surface storage calculation after the wetting process is completed. The surface storage is filled only if the current infiltration rate is smaller than the actual precipitation intensity reduced by evaporation. The actual surface storage loss is calculated according to the following:

$$I_S(t) = \begin{cases} I(t) - I_E(t) - I_W(t) - I_I(t) & \text{for } y(t) \leq (y_w + y_s) \\ 0 & \text{for } y(t) > (y_w + y_s) \end{cases} \quad (7.44)$$

Where:

| | |
|----------|-------------------------------------|
| $I(t)$ | Precipitation intensity at time t |
| $I_S(t)$ | Surface storage loss at time t |
| $I_I(t)$ | Infiltration loss at time t |
| $I_W(t)$ | Wetting loss at time t |
| $I_E(t)$ | Evaporation loss at time t |
| y_w | Wetting depth |
| y_s | Surface storage depth |
| $y(t)$ | Accumulated depth at time t |



Surface Runoff routing computation

The runoff starts when the effective precipitation intensity is larger than zero. The hydraulic process is described with the kinematic wave equations for the entire surface at once. This description assumes uniform flow conditions on the catchment surface, i.e. equal water depth over the entire surface of certain category.

This type of runoff model is also called a non-linear reservoir model.

The surface runoff at time t is calculated as:

$$Q(t) = M \cdot B \cdot I^{1/2} \cdot y_R(t)^{5/3} \quad (7.45)$$

Where:

| | |
|----------|--|
| M | Manning's number |
| B | Flow channel width, computed as: $B \text{ [m]} = A \text{ [m}^2\text{]} / L \text{ [m]}$ |
| I | Surface slope |
| $y_R(t)$ | Runoff depth at time t |

The depth $y_R(t)$ is determined from the continuity equation:

$$I_{\text{eff}}(t) \cdot A - Q(t) = \frac{dy_R}{dt} \cdot A \quad (7.46)$$

Where:

| | |
|------------------|-------------------------------------|
| I_{eff} | Effective precipitation |
| A | Contributing catchment surface area |
| dt | Time step |
| dy_R | Change in runoff depth |

Hydrological losses depending on surface type

The Kinematic Waves Surface Runoff Model distinguishes between up to 5 different catchment surface types. This is practically handled by the model so that the individual catchment is split into up to five sub-catchments, each with the area according to the specified percentages for specific surface categories.



For each surface type, only relevant processes are simulated. An overview of the processes associated with different surface types is shown in Table 7.9.

Table 7.9 Processes included for various types of catchment surface

| Surface Type | Hydrological Loss Simulated |
|------------------|---|
| Impervious Steep | Evaporation Wetting |
| Impervious Flat | Evaporation Wetting Storage |
| Pervious small | Evaporation Wetting Infiltration Storage |
| Pervious medium | Evaporation Wetting Infiltration Storage |
| Pervious large | Evaporation Wetting Infiltration Storage |

The model treats every area with different surface category as a sub-catchment, and the runoff computations are performed individually. The total runoff from the entire catchment is obtained then as a sum of runoffs from up to five different sub-catchments.

Definition of the sub-catchment geometry

The length and width for each sub-catchment (sub-area) are calculated so that the length/width ratio for each sub-area is kept equal to the length/width ratio of the corresponding catchment. Based on the information for the whole catchment and the principle of constant length/width ratio, equivalent values of the runoff width and length are computed for all sub-areas, as illustrated in the example below (Figure 7.10).

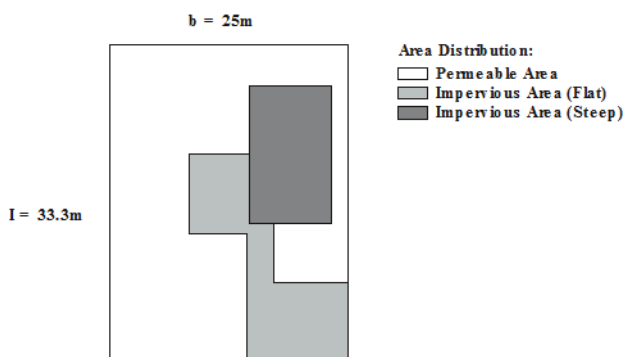

Figure 7.10 Sub-catchments with total area = 833 m^2

The ratio between the catchment length and width in the given example corresponds to 1.33. 15% of the total area is impervious roof surface corresponding to 125 m^2 . Hence the runoff length is 12.9 m and the runoff width is 9.7 m for this surface type, as $12.9 * 9.7 = 125$ and $9.7 * 1.33 = 12.9$.

7.4.4 Multiple-Event Simulations

If the Kinematic Wave Surface Runoff Model is used for a continuous simulation of multiple rainfall events, a special solution has been applied for the simulation of dry periods between the consecutive events. The solution accounts for the following phenomena:

Recovery of the soil infiltration capacity

According to Horton equations, the soil infiltration capacity is getting reduced as the soil gets more saturated by rain. In dry periods, an inverse process occurs, with gradual recovery of the infiltration capacity. Computation of both processes is detailed in Section 7.4.3.

As a consequence of wet and dry period alternation in a multiple event simulation, the model alternates between the two computation modes. Switching to the “dry” mode is triggered by the exhaustion of all water available for infiltration. Consecutively, switch to the “wet” mode at the start of a new rain event.

Recovery of the initial loss capacity during dry intervals

The occurrence of the initial loss at the beginning of each simulated event is modelled in accordance with reality. During dry periods, the initial loss capacity will be recovered if no evaporation time series has been provided. In other words, the recovery of the initial loss capacity is meant to replace the actual evaporation.



In this context, start of a dry period is defined if three conditions are fulfilled simultaneously:

- No rainfall: all connected rain gauges show no rain, i.e. the rainfall intensity is null
- No infiltration: the infiltration has stopped in the catchment (and not necessary in all catchment like it is done in MOUSE)
- No runoff: the runoff from the catchment included in the simulation has fallen below the “low flow” limit. The threshold can be controlled through the parameter **RUNOFF_B_LOW_FLOW** in the INI file (see relevant documentation for reference).

At the start of a dry period, the initial loss storage would appear fully or partially filled up. For flat impervious surfaces, the full initial loss storage would contain the water used for wetting and filling of the surface storage, while for all other surface types only wetting loss will apply. The latter case, i.e. partially filled storage would apply for small events with the total depth smaller than the corresponding initial loss storage capacity.

Recovery of the initial loss capacity, i.e. the process of surface drying is simulated as a constant “decay” rate, which replaces the actual evaporation. As a consequence of the recovery process, the initial loss storage would be fully or partially emptied, which depends on the actually applied loss recovery rate and the duration of the dry period.

The initial loss recovery rate can be controlled through **RUNOFF_B_INIT-LOSS_RECOVER** found in the INI file (see relevant documentation for reference).

The recovery process is only activated during dry periods, i.e. the evaporative action during rain events is neglected. Note that if actual evaporation process is activated, the recovery process is suppressed and evaporative action is activated throughout the simulation period.



In order to speed up the simulation, dry periods between events are per default simulated with longer time steps. The dry period time step is controlled through the parameter **RUNOFF_B_LOW_FLOW** found in the INI file (see relevant documentation for reference). Switching to different time step in dry period can be suppressed by setting the parameter **RUNOFF_B_Variable_dT** found the ini file (see relevant documentation for reference). This functionality is not available from MIKE 11. ■

7.5 Linear Reservoir Surface Runoff Model

7.5.1 Concept



The Linear reservoir surface runoff computation of MIKE 1D is founded on the linear reservoir equations for routing the runoff through the catchment. This means that the surface runoff from a catchment is made proportional to the current water depth. In addition to the linear reservoir model, a French localised version has also been implemented.

The runoff amount is controlled by the initial losses, size of the actually contributing area and by infiltration losses. The shape of the runoff hydrograph (phase and amplitude) is controlled by the catchment time constant.

7.5.2 Input data

Model data are split into the global model and the French localised version.

Model-specific data

Global model

Effective area [-] represents the fraction of the catchment area considered to contribute effectively to the runoff.

French model (FR)

Impervious area [-] represents the fraction of the catchment area considered to contribute to the runoff. Calculations of the infiltration and the runoff will differ depending on value of the parameter:

Impervious area ≥ 0.2 : catchment is **urban**

Impervious area < 0.2 : catchment is **rural**

Length [m] represents the estimation of the maximum runoff length from the periphery of the catchment to the point of connection used in the empirical calculation of the catchments lag time constant

Slope [-] represents the estimation of the average runoff slope used in the empirical calculation of the catchments lag time constant.

Hydrological Parameters

Global model

Initial Loss [m] defines the precipitation depth required to start the surface runoff. This is a one-off loss, comprising the wetting and filling of catchment depressions.

The default value is $5.00 \cdot 10^{-4}$ m.



Time constant [s^{-1}] is the linear reservoir time constant controlling the shape of the runoff hydrograph (reaction time).

The default value is $3.00 \cdot 10^{-3} s^{-1}$.

French model (FR)

The reduction factor [-] accounts for various hydrological losses not accounted explicitly in the computation.

The default value is 0.90.

The lag time [s] is the reciprocal equivalent of the linear reservoir time constant.

The default value is 300 s.

Infiltration

Start Infiltration rate [m/s] defines the maximum rate of infiltration (Horton) for the specific surface type.

The default value is $0.50 \cdot 10^{-6} m/s$.

End Infiltration rate [m/s] defines the minimum rate of infiltration (Horton) for the specific surface type.

The default value is $0.14 \cdot 10^{-6} m/s$.

Wet Horton exponent [s^{-1}] is the time factor “characteristic soil parameter” used in the Horton’s equation. It determines the infiltration capacity rate reduction during rainfall.

The default value is $8.30 \cdot 10^{-4} s^{-1}$.

Dry Horton exponent [s^{-1}] is the time factor used in the “inverse Horton’s equation”, defining the rate of the soil infiltration capacity recovery after a rainfall, i.e. in a drying period.

The default value is $0.28 \cdot 10^{-4} s^{-1}$.

Recommended parameter values for various types of catchments are presented in Table 7.10.

Table 7.10 [Table 4.1 Recommended values of parameters for Linear reservoir model for various types of catchment surfaces.](#)



| Surface type | Runoff type | Time constant (1/min) | Initial loss (mm) | Infiltration Capacity (mm/h) | | Time coefficient (1/h) | |
|-----------------------------|---------------|-----------------------|-------------------|------------------------------|------|------------------------|------|
| | | | | max. | min. | max. | min. |
| Fully impervious ground | steep | 0.5 | 0.0 | - | - | - | - |
| | flat | 0.2 | 0.5 | - | - | - | - |
| | extended flat | 0.1 | 1.0 | - | - | - | - |
| Partially impervious ground | steep | 0.5 | 0.0 | 2.0 | 0.5 | 3.0 | 0.1 |
| | flat | 0.2 | 0.5 | 2.0 | 0.5 | 3.0 | 0.1 |
| | extended flat | 0.1 | 2.0 | 2.0 | 0.5 | 3.0 | 0.1 |
| Roof | steep | 0.5 | 0.0 | - | - | - | - |
| | flat | 0.2 | 2.0 | - | - | - | - |
| | extended flat | 0.1 | 4.0 | - | - | - | - |
| Pervious ground (soil) | steep | 0.5 | 2.0 | 5.0 | 1.0 | 3.0 | 0.1 |
| | flat | 0.2 | 4.0 | 5.0 | 1.0 | 3.0 | 0.1 |
| | extended flat | 0.1 | 6.0 | 5.0 | 1.0 | 3.0 | 0.1 |

7.5.3 Runoff computation

The runoff computations are based on the volume continuity and the linear reservoir equations.

The first step is the calculation of the effective precipitation intensity. The effective precipitation intensity is the precipitation, which contributes to the surface runoff. Next, the hydraulic routing based on the linear reservoir principle and volume continuity is applied.

The localised version proposed a different calculation of the losses and the hydraulic routing. Three different types may be used:

1. Global model
2. French Urban model
3. French Rural model

The Impervious area input is the parameter used in the rule deciding whether a French catchment is Urban and Rural.

The hydrologic and hydraulic processes involved are shown in the diagram in Figure 7.11.

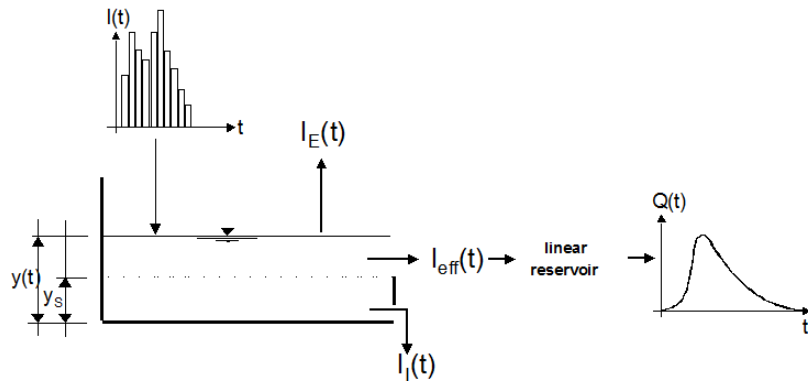

Figure 7.11 The processes simulated in the Linear reservoir surface runoff model

Effective precipitation computation

The simulated hydrologic processes account for the losses - evaporation, infiltration and surface storage - calculated according to the conventions and equations in the order presented below. The remaining precipitation is called **effective precipitation**, defined generally as:

$$I_{eff}(t) = I(t) - I_E(t) - I_I(t) - I_S(t) \tag{7.47}$$

Where:

- $I(t)$ Actual precipitation intensity at time t
- $I_E(t)$ Evaporation loss at time t . It should be noted that the evaporation loss for the catchment is accounted only if the evaporation explicitly is activated. Otherwise, it is replaced by a constant decay rate
- $I_S(t)$ Initial loss (wetting and surface storage) at time t
- $I_I(t)$ Accumulated depth at time t

The individual terms in the loss equation are fundamentally different, as some terms are continuous where others are discontinuous. If the calculated loss is negative, it is set to zero. The losses have a dimension of velocity [LT⁻¹].

The actual precipitation, $I(t)$, is assumed to be uniformly distributed over the individual catchments. Otherwise, it may vary as a random time function.

The surface storage, $I_S(t)$, is the loss due to wetting and filling the depressions and holes in the terrain. The model begins with the surface storage calculation after the wetting process is completed. The surface storage is filled



only if the current infiltration rate is smaller than the actual precipitation intensity reduced by evaporation. The actual surface storage loss is calculated according to the following:

$$I_S(t) = \begin{cases} I(t) - I_E(t) - I_I(t) & \text{for } y(t) \leq y_S \\ 0 & \text{for } y(t) > y_S \end{cases} \quad (7.48)$$

Where:

| | |
|----------|-------------------------------------|
| $I(t)$ | Precipitation intensity at time t |
| $I_S(t)$ | Surface storage loss at time t |
| $I_I(t)$ | Infiltration loss at time t |
| $I_E(t)$ | Evaporation loss at time t |
| y_S | Surface storage depth |
| $y(t)$ | Accumulated depth at time t |

The infiltration, $I_I(t)$, is the water loss to the lower storage caused by the porosity of the catchment surface. It is assumed that the infiltration starts when the wetting of the surface has been completed. The infiltration loss is calculated according to the following relations:

$$I_I(t) = \begin{cases} I_H(t) & \text{for } I(t) - I_E(t) \geq I_H(t) \\ I(t) - I_E(t) & \text{for } I(t) - I_E(t) < I_H(t) \\ 0 & \text{for } I(t) \leq I_E(t) \end{cases} \quad (7.49)$$

Where:

| | |
|----------|---|
| $I_I(t)$ | Infiltration loss at time t |
| $I_H(t)$ | Horton's infiltration at time t (see below) |

By default the infiltration is taken into account in the calculation if the option is activated. However, the French Urban catchment will disregard any infiltration, even if it has been activated.

Valid for Global and French Rural models, only:

The infiltration is a complex phenomenon, dependent on the soil porosity, moisture content, groundwater level, surface conditions, storage capacity,



etc. The model calculates the infiltration loss capacity using the well-known Horton's equation, per default in its original form:

$$I_H(t) = I_{Imin} + (I_{Imax} - I_{Imin}) \cdot e^{-k_a \cdot t} \tag{7.50}$$

Where:

| | |
|------------|--|
| $I_H(t)$ | Infiltration loss calculated according to Horton |
| I_{Imax} | Maximum infiltration capacity (at start) |
| I_{Imin} | Minimum infiltration capacity (at full saturation) |
| t | Time since the start of the storm |
| k_a | Time factor (characteristic soil parameter) for wetting conditions |

By default the model is able to calculate the infiltration following the standard and the integrated form of Horton's equation. However the French rural model only offers the possibility to calculate the infiltration only according to the standard form.

Valid for Global model, only (not valid for the French model):

The Horton's equation in its original form, Equation (7.50), yields in realistic results only if applied to events for which the rainfall intensity always exceeds the infiltration capacity. However, typical values for infiltration capacity parameters I_{Imax} and I_{Imin} are often greater than typical rainfall intensities. Thus, when Equation (7.50) is used, with infiltration capacity I_H being the function of time only, I_H will decrease even if rainfall intensities are very small. In other words, this results in a reduction in infiltration capacity regardless of the actual amount of water entering the soil. This problem is solved by implementing the integrated form of the Equation (7.50):

$$I_{ICUM}(t_p) = \int_0^{t_p} I_H dt = I_{Imin} \cdot t_p + \frac{I_{Imax} - I_{Imin}}{k_a} \cdot (1 - e^{-k_a t_p}) \tag{7.51}$$

Where:

| | |
|----------------|--|
| $I_{CUM}(t_p)$ | A cumulative infiltration (m) at time t_p , i.e. the area under the Horton's curve |
|----------------|--|

This assumes that the actual infiltration has been equal to the infiltration capacity at any time within the period $0 \rightarrow t$. Since this is only the case for rain-



fall intensities higher than the infiltration capacity, this needs to be corrected as:

$$I_{CUM}(t) = \int_0^t I_f dt \quad (7.52)$$

i.e. the cumulative infiltration at the elapsed time t is calculated using the actually occurred infiltration.

At any elapsed time t , the two equations (7.51) and (7.52) can be used to determine the “equivalent” time t_p . This is done iteratively, since equation (7.51) cannot be solved explicitly for t_p .

The time t_p on cumulative Horton's curve will always be less or equal than the actually elapsed time, implying that the available infiltration capacity at time t_p will be greater than or equal to that given by the equation (7.50). By these means, the infiltration capacity has been made a function of actual water infiltrated and not just a function of time.

Application of a “standard” Horton's equation (7.50) or its integrated form (equations (7.51) and (7.52)) is controlled by the switch **IntegratedHorton**, found in INI file (see relevant documentation for reference). Per default, the program is set to “standard” Horton's equation.

In the dry period following the rainfall, the infiltration capacity is gradually recovered to the initial value, using an inverse form of the Horton's equation:

$$I_H(t) = I_{IT} + (I_{Imax} - Q_{IT}) \cdot e^{-1/k_h t} \quad (7.53)$$

Where:

| | |
|------------|--|
| $I_H(t)$ | Infiltration loss capacity calculated according to Horton |
| I_{Imax} | Maximum infiltration capacity (after a long dry period) |
| I_{IT} | Infiltration capacity at the threshold between the wetting and drying period |
| t | Time since the start of the recovery process |
| k_h | Time factor (characteristic soil parameter) for drying conditions |

The evaporation, $I_E(t)$, is a continuous loss that is normally of less significance for single event simulations. However, on a long-term basis, evaporation accounts for a significant part of hydrological losses. If included in the



computation, the evaporation is the first part subtracted from the actual precipitation, according to the following:

$$I_E(t) = \begin{cases} I_E(t) & \text{for } (I(t) \geq I_{PE}(t)) \text{ OR } (y(t) > 0) \\ I(t) & \text{for } (I(t) < I_{PE}(t)) \text{ AND } (y(t) = 0) \end{cases} \quad (7.54)$$

Where:

| | |
|-------------|-----------------------------------|
| $I(t)$ | Actual precipitation at time t |
| $I_E(t)$ | Evaporation loss at time t |
| $I_{PE}(t)$ | Potential evaporation at time t |
| $y(t)$ | Accumulated depth at time t |

If the evaporation has not been explicitly included in the simulation (i.e. evaporation process is activated and a time series is included), a constant decay rate is applied instead (see Section 7.5.4).

Surface Runoff routing computation

The runoff starts when the effective precipitation intensity is larger than zero. The hydraulic process is described with the linear reservoir equation.

Linear reservoir equation

The surface runoff at time t is calculated as:

$$Q(t) = C \cdot y_R(t)^{5/3} \quad (7.55)$$

Where:

| | |
|----------|---------------------------|
| C | Linear reservoir constant |
| $y_R(t)$ | Runoff depth at time t |

The depth $y_R(t)$ is determined from the continuity equation:

$$I_{eff}(t) \cdot A - Q(t) = \frac{dy_R}{dt} \cdot A \quad (7.56)$$



Where:

| | |
|------------------|-------------------------------------|
| I_{eff} | Effective precipitation |
| A | Contributing catchment surface area |
| dt | Time step |
| dy_R | Change in runoff depth |

Linear reservoir constant

By default, the linear reservoir constant C is equal to the catchment time constant.

The French model calculates the constant in different ways. The reservoir constant is calculated as follow:

If the lag time is greater than 10^{-5} s:

$$C = \frac{1}{T_L} \quad (7.57)$$

Where:

| | |
|-------|--------------------|
| T_L | Catchment lag time |
|-------|--------------------|

Otherwise, the model provides an empirical formula for the calculation of the reciprocal value K ($= 1 / C$) of the reservoir constant C as:

$$K = 0.494 \cdot A^{-0.0076} \cdot I^{-0.512} \cdot S^{-0.401} \cdot L^{0.608} \quad (7.58)$$

The lag time is corrected depending on imperviousness and size:

- for Urban catchment: $K_C = 0.5 \cdot K$
- for Rural catchment:
 - $A < 6$ ha: $K_C = 0.8 \cdot K$
 - $6 \leq A < 250$ ha: $K_C = 0.7 \cdot A^{-0.009} \cdot K$
 - $A \geq 250$ ha: $K_C = K$

Where:

| | |
|-----|--|
| A | Total catchment surface area (ha) |
| I | Impervious part of the catchment (0.....1.0) |



| | |
|---|----------------------|
| S | Catchment slope (%) |
| L | Catchment length (m) |

Surface runoff computation

A single linear reservoir equation is applied by default.

$$Q(t_i) = Q(t_{i-1})e^{-C \cdot dt} + Q_i(t_i) \cdot (1 - e^{-C \cdot dt})$$

For the French Rural catchment the double linear equation is applied.

$$Q_1(t_i) = Q_1(t_{i-1})e^{-C \cdot dt} + Q_i(t_i) \cdot (1 - e^{-C \cdot dt})$$

$$Q(t_i) = Q(t_{i-1})e^{-C \cdot dt} + Q_1(t_i) \cdot (1 - e^{-C \cdot dt})$$

Where:

| | |
|----------------|---|
| $Q(t_i)$ | Total runoff at time step t_i |
| $Q(t_{i-1})$ | Total runoff at previous time step t_{i-1} |
| $Q_1(t_i)$ | Outflow of the intermediate reservoir at time step t_i |
| $Q_1(t_{i-1})$ | Outflow of the intermediate reservoir at previous time step t_{i-1} |
| C | Linear reservoir constant |
| dt | Time step length |

7.5.4 Multiple-event simulations

In order to speed up the calculations, a different time step is applied during dry periods and a special solution has been applied for the simulation of dry periods between the consecutive events. The solution accounts for the following phenomena:

In this context, start of a dry period is defined if three conditions are fulfilled simultaneously:

- No rainfall: all connected rain gauges show no rain, i.e. the rainfall intensity is null
- No infiltration: the infiltration has stopped in the catchment (and not necessary in all catchment like it is done in MOUSE)



- No runoff: the runoff from the catchment included in the simulation has fallen below the “low flow” limit. The threshold can be controlled through the parameter **NL_CONCEPT_DRYDEPTH** in the INI file (see relevant documentation for reference)

At the start of a dry period, the initial loss storage would appear fully or partially filled up. For flat impervious surfaces, the full initial loss storage would contain the water used for wetting and filling of the surface storage, while for all other surface types only wetting loss will apply. The latter case, i.e. partially filled storage would apply for small events with the total depth smaller than the corresponding initial loss storage capacity.

If evaporation is not specified, recovery of the initial loss capacity, i.e. the process of surface drying is simulated as a constant “decay” rate, which replaces the actual evaporation. As a consequence of the recovery process, the initial loss storage would be fully or partially emptied, which depends on the actually applied loss recovery rate and the duration of the dry period.

The initial loss recovery rate can be controlled through **RUNOFF_C_INIT-LOSS_RECOVER** found in the INI files (see relevant documentation for reference).

The recovery process is only activated during dry periods, i.e. the action during rain events is neglected. Note that if actual evaporation process is activated, the recovery process is suppressed and evaporative action is activated throughout the simulation period. ■

7.6 Unit Hydrograph Surface Runoff Model (UHM)

7.6.1 Concept

The UHM module simulates the runoff from **single storm events** for any number of catchments defined in the MIKE 1D model setup, by the use of the well-known unit hydrograph technique. As such, UHM constitutes an alternative to the other runoff models available in MIKE 1D, for the runoff simulation in the areas where no flow records are available or where unit hydrograph technique has already been well established.

The unit hydrograph model calculates the excess rainfall (precipitation) assuming that the losses to infiltration can be described as a fixed initial and constant loss, a proportional loss (the rational method) or by the U.S. Soil Conservation Service (SCS) curve number method or finally by the generalised SCS method.

The excess rainfall is routed by the unit hydrograph method. The module applies the SCS-dimensionless hydrographs or the Snyder Unit Hydrograph.

In order to setup a UHM model three sub models are to be defined:



- The loss model
- The hydrograph type
- The lag time model

7.6.2 The loss model

During a rainstorm, a part of the rainfall infiltrates to the soil. Subsequently, a large part of the infiltrated water evaporates, while only a relatively small fraction reaches the drainage network. Hence, in single-event models such as UHM, it is reasonable to describe the major part of the infiltration as a loss. The amount of precipitation actually reaching the sewer system, i.e. the total amount of rainfall reduced by the loss, is termed the excess precipitation.

The unit hydrograph model includes **four optional methods** for calculation of excess precipitation. They are all lumped models, considering each catchment as one unit and hence the parameters represent average values for the catchment.

All the methods include an area adjustment factor [-], accounting to some extent for a non-uniform distribution of precipitation over the catchment.

Proportional loss model (the rational method)

Input data

Input that must be set for this loss model: **Runoff coefficient [-]**

Loss computation

In this method the losses are assumed to be proportional to the precipitation rate and thus the excess precipitation is given by:

$$P_{\text{excess}} = a \cdot A_f \cdot P \quad (7.59)$$

Where:

| | |
|---------------------|---|
| P_{excess} | Excess precipitation (m/s) |
| a | User-defined runoff coefficient between 0 and 1 |
| A_f | Area adjustment factor |
| P | Precipitation rate (m/s) |



Constant Loss Model

Input data

Inputs that must be set for this loss model:

Initial loss [m] occurring at the beginning of the storm.

Constant loss [m/s] that occurs during the entire storm.

Loss computation

According to this method, no excess precipitation will be generated before a user-specified initial loss has been met. Subsequently, excess precipitation will be generated whenever the precipitation rate exceeds a specified constant loss rate, i.e.:

$$P_{\text{excess}} = \begin{cases} 0; & \text{for } P_{\text{sum}} < I_a + I_c \cdot dt \\ A_f \cdot P \cdot I_c & \text{for } P_{\text{sum}} > I_a \end{cases} \quad (7.60)$$

Where:

| | |
|---------------------|--|
| P_{excess} | Excess precipitation (m/s) |
| P_{sum} | Accumulated precipitation since start of storm event (m) |
| I_a | User-defined initial loss (m) |
| I_c | User-defined constant loss rate (m/s) |
| A_f | Area adjustment factor |
| P | Precipitation rate (m/s) |
| dt | Calculation time step (s) |

To some extent this method accounts for the fact that losses are greatest at the start of the storm.

SCS Loss Model

The U.S. Soil Conservation Service (SCS), /1/, developed this method for computing losses from storm rainfall in 1972.

Input data

Inputs that must be set for this loss model:



Initial antecedent moisture conditions (AMC) [-]
Curve number [-]

Loss computation

For the storm as a whole, the depth of excess precipitation or direct runoff P_e is always less than or equal to the depth of precipitation P . Likewise, after the runoff begins, the additional depth of water retained in the catchment, F_a , is smaller than or equal to some potential maximum retention S (see Figure 7.12). There is a certain amount of rainfall I_a , (initial loss before ponding) for which no runoff occurs. Consequently, the potential runoff amounts to $P - I_a$.

The hypothesis of the SCS method is that the ratios of the two actual to the two potential quantities are equal, i.e.:

$$\frac{F_a}{S} = \frac{P_e}{P - I_a} \quad (7.61)$$

The continuity principle results in:

$$P = P_e + I_a + F_a \quad (7.62)$$

Combining Equations (7.61) and (7.62) gives:

$$P_e = \frac{(P - I_a)^2}{P - I_a + S} \quad (7.63)$$

which is the basic equation for computing the depth of excess precipitation or direct runoff from a storm by the SCS method.

The results from many small experimental watersheds were used to obtain an empirical relationship:

$$I_a = 0.2S \quad (7.64)$$

The basic equation used in this model is derived by combining Equations (7.63) and (7.64):

$$P_e = \frac{(P - 0.2S)^2}{P + 0.8S} \quad (7.65)$$

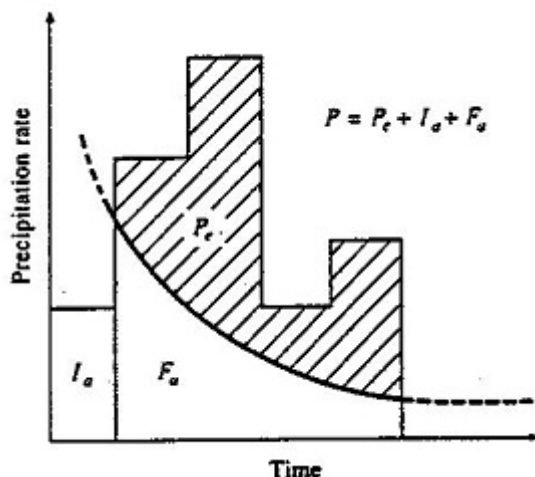

Figure 7.12 Variables in the SCS method of rainfall abstractions: I_a = initial abstraction, P_e = accumulated excess rain, F_a = continuing abstraction, P = total rainfall

The potential maximum retention S is calculated from a dimensionless curve number (CN) using the empirical formula derived by SCS on the basis of rainfall-runoff analyses from a large number of catchments:

$$S = \left(\left(\frac{1000}{CN} \right) - 10 \right) \cdot 25.4 \cdot 10^{-3} \quad [m] \quad (7.66)$$

The curve number depends on the soil type, the land use and the antecedent moisture condition (AMC) at the beginning of the storm.

CN varies between 0, resulting in no runoff and 100, which generates an excess precipitation equal to the actual precipitation. For natural catchments normally $50 < CN < 100$ applies.

The model operates with three different antecedent moisture conditions namely:

- | | |
|----------|--|
| AMC(I) | Dry conditions close to wilting point |
| AMC(II) | Average wet conditions close to field capacity |
| AMC(III) | Wet conditions close to saturation |

For each calculation time step, the excess precipitation is calculated as the difference between the accumulated excess precipitation P_e at the start and the end of the time step.



The SCS method was developed on the basis of daily rainfall and consequently the program considers the beginning of a new 24-hour period at the beginning of a new storm event, i.e.:

- Each 24 hours *AMC* is updated by one class for each 16 mm of rain falling during the simulation period.
- *CN* and *S* are recalculated in correspondence with the updated *AMC*. The conversion of *CN* due to *AMC* is done using Table 7.11.
- The accumulated rainfall amount P_e is reset to zero.

Table 7.11 Correlation between SCS Curve numbers and the antecedent moisture condition as given in /1/.



| Antecedent moisture conditions | | | | | | | | |
|--------------------------------|----|-----|----|----|-----|-----|-----|-----|
| II | I | III | II | I | III | II | I | III |
| 0 | 0 | 0 | 34 | 18 | 54 | 68 | 48 | 84 |
| 1 | 0 | 3 | 35 | 18 | 55 | 69 | 50 | 84 |
| 2 | 1 | 5 | 36 | 19 | 56 | 70 | 51 | 85 |
| 3 | 1 | 8 | 37 | 20 | 57 | 71 | 52 | 86 |
| 4 | 2 | 10 | 38 | 21 | 58 | 72 | 53 | 86 |
| 5 | 2 | 13 | 39 | 21 | 59 | 73 | 54 | 87 |
| 6 | 2 | 15 | 40 | 22 | 60 | 74 | 55 | 88 |
| 7 | 3 | 17 | 41 | 23 | 61 | 75 | 57 | 88 |
| 8 | 3 | 18 | 42 | 24 | 62 | 76 | 58 | 89 |
| 9 | 4 | 20 | 43 | 25 | 63 | 77 | 59 | 89 |
| 10 | 4 | 22 | 44 | 25 | 64 | 78 | 60 | 90 |
| 11 | 4 | 24 | 45 | 26 | 65 | 79 | 62 | 91 |
| 12 | 5 | 25 | 46 | 27 | 66 | 80 | 63 | 91 |
| 13 | 5 | 27 | 47 | 28 | 67 | 81 | 64 | 92 |
| 14 | 6 | 28 | 48 | 29 | 68 | 82 | 66 | 92 |
| 15 | 6 | 30 | 49 | 30 | 69 | 83 | 67 | 93 |
| 16 | 7 | 31 | 50 | 31 | 70 | 84 | 68 | 93 |
| 17 | 7 | 33 | 51 | 31 | 70 | 85 | 70 | 94 |
| 18 | 8 | 34 | 52 | 32 | 71 | 86 | 72 | 94 |
| 19 | 8 | 36 | 53 | 33 | 72 | 87 | 73 | 95 |
| 20 | 9 | 37 | 54 | 34 | 73 | 88 | 75 | 95 |
| 21 | 10 | 38 | 55 | 35 | 74 | 89 | 76 | 96 |
| 22 | 10 | 39 | 56 | 36 | 75 | 90 | 78 | 96 |
| 23 | 11 | 41 | 57 | 37 | 75 | 91 | 80 | 97 |
| 24 | 11 | 42 | 58 | 38 | 76 | 92 | 81 | 97 |
| 25 | 12 | 43 | 59 | 39 | 77 | 93 | 83 | 98 |
| 26 | 13 | 44 | 60 | 40 | 78 | 94 | 85 | 98 |
| 27 | 13 | 46 | 61 | 41 | 78 | 95 | 87 | 98 |
| 28 | 14 | 47 | 62 | 42 | 79 | 96 | 89 | 99 |
| 29 | 14 | 49 | 63 | 43 | 80 | 97 | 91 | 99 |
| 30 | 15 | 50 | 64 | 44 | 81 | 98 | 94 | 99 |
| 31 | 16 | 51 | 65 | 45 | 82 | 99 | 97 | 100 |
| 32 | 16 | 52 | 66 | 46 | 82 | 100 | 100 | 100 |
| 33 | 17 | 53 | 67 | 47 | 83 | | | |

SCS Generalised Loss Model

Research has shown that it may be beneficial to apply another loss model than the standard SCS loss model. The SCS generalised loss model does not make use of the concept of an antecedent moisture content (AMC) but applies a general antecedent storage depth. This loss model in combination with the SCS unit hydrograph routing model complies completely with the TP108 approach often used in e.g. New Zealand and the United States.

Input data

Inputs that must be set for this loss model:



Initial abstraction depth [m]
Curve number [-]

Loss computation

The SCS generalised loss model corresponds closely to the SCS standard loss model. However, it differs in a few important ways. The excess precipitation is still calculated by Equation (7.63):

$$P_e = \frac{(P - I_a)^2}{P - I_a + S} \quad (7.67)$$

but in this model the initial loss (initial abstraction depth) I_a is given directly as an input parameter.

The potential maximum retention S is calculated from a dimensionless curve number (CN) using the formula:

$$S = \left(\left(\frac{1000}{CN} \right) - 10 \right) \cdot 25.4 \cdot 10^{-3} \quad [m] \quad (7.68)$$

The curve number is an input parameter and is not changed during the simulation as for the SCS standard loss model.

7.6.3 Unit hydrograph routing model

Basic assumptions

The unit hydrograph method is a simple linear model that can be used to derive the hydrograph resulting from any amount of excess precipitation.

The unit hydrograph is a unit pulse response function of a linear hydrological system, i.e. the direct runoff hydrograph resulting from one unit of excess precipitation with the duration t_r .

The following basic assumptions are inherent in this model:

- Excess precipitation has a constant intensity within the effective duration,
- Excess precipitation is uniformly distributed over the whole catchment area.
- The base time of the direct runoff hydrograph resulting from an excess precipitation with a given duration is constant.
- The ordinates of all direct runoff hydrographs of a common base time are directly proportional to the total amount of excess precipitation represented by each hydrograph.

- The principle of superposition applies to hydrographs resulting from continuous and/or isolated periods of uniform-intensity excess precipitation, as illustrated in Figure 7.13.
- For a given catchment, the hydrograph resulting from a given excess precipitation reflects the unchanging conditions of the catchment.

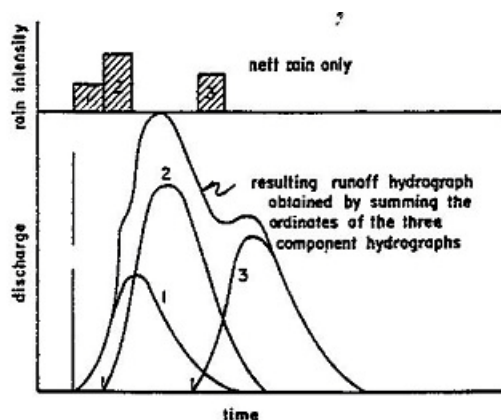

Figure 7.13 Principle of superposition applied to hydrographs

Under natural conditions, the above assumptions cannot be perfectly met. However, in many cases the hydrological conditions come close enough to the above assumptions to generate satisfactory results. A more detailed discussion of the above assumptions can be found in /2/.

Principle of Calculation

In accordance with the principle of superposition, for each calculation time step the model determines the hydrograph corresponding to the excess rainfall, as generated by the loss model during this time step, and adds the response to the flow contributions generated in previous time steps.

Unit hydrograph models

SCS Unit Hydrographs

A unit hydrograph can be characterised by the duration of the unit rainfall t_r , resulting in the hydrograph and the lag time t_l , defined as the time difference between the centre of the unit rainfall event and the runoff peak.

From these two characteristics, the time to peak T_p , i.e. the time from the beginning of the storm event until the occurrence of peak runoff can be calculated as:

$$T_p = \frac{t_r}{2} + t_l \quad (7.69)$$



In reality, the unit hydrograph of a given catchment is unique. However, large efforts have been put into the development of synthetic unit hydrographs which are more or less generally applicable. Two such hydrographs are pre-specified in the model (see Figure 7.14):

- SCS triangular unit hydrograph
- SCS dimensionless hydrographs

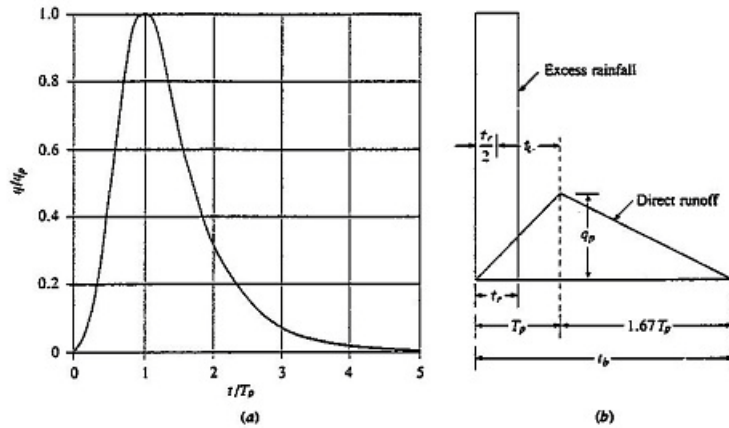

Figure 7.14 SCS Synthetic Hydrographs: (a) Dimensionless hydrograph; (b) Triangular hydrograph

The user must specify the lag time to be used in a given calculation. The program will then scale the applied hydrograph accordingly, ensuring that the area under the curve equals to unity.

There are two ways of specifying the lag time:

- User defined value.
- Calculated from catchment characteristics using the standard SCS formula:

$$t_l = (L \cdot 3.28 \cdot 10^3)^{0.8} \cdot \frac{(1000/CN - 9)^{0.7}}{(1900 \cdot Y^{0.5})} \quad (7.70)$$

Where:

t_l Lag time in hours

L Hydraulic length of the catchment in km



- CN The SCS curve number
- Y The average catchment slope in per cent

A unit-hydrograph derived from a time-area curve is considered as catchment-specific. Consequently, specification of arbitrary lag times are not allowed if the time-area method is applied. The program will simply use the lag time implicitly given by the time-area curve.

The time-area method in the UHM-model performs a pure translation of the excess precipitation hydrograph via the drainage network described using the channel travel time. This results in an outflow hydrograph, which ignores catchment storage effects.

Snyder Unit Hydrograph (SUH)

Standard SUH

From an analysis of ungaged watersheds varying in size from 30 to 30,000 km² in the Appalachian Highlands in the United States, Snyder published a description of a standard and required synthetic unit hydrographs in 1938. He published a relationship for estimating the unit hydrograph parameters from watershed characteristics. The relationship is shown in Figure 7.15.

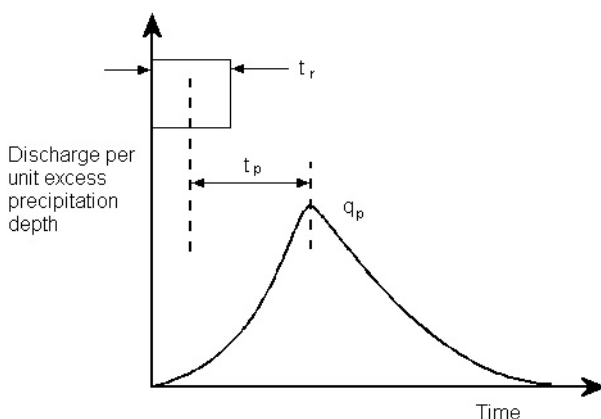

Figure 7.15 Snyder's Synthetic Unit Hydrograph

For the standard unit hydrograph, Snyder defined the basin lag time t_p in hours to be related to the rainfall duration t_r in hours as follows:

$$t_p = 5.5 t_r \quad (7.71)$$



For the required unit hydrograph, Snyder defined the basin lag time to be related to the watershed characteristics as follows:

$$t_p = C_1 C_t (LL_c)^{0.3} \quad (7.72)$$

Where:

| | |
|-------|---|
| t_p | Lag time in hours |
| C_1 | Conversion constant of 0.75 |
| C_t | Watershed coefficient |
| L | Length of main stream from the outlet to the divide in km |
| L_c | Length of main stream from the outlet to a point nearest watershed centroid in km |

The peak discharge per unit drainage area is found with the following relationship:

$$q_p = \frac{C_2 C_p}{t_p} \quad (7.73)$$

Where:

| | |
|-------|---|
| q_p | Peak discharge per unit drainage area in m^3 per sec km^2 |
| C_2 | Conversion constant of 2.75 |
| C_p | Peaking coefficient |
| t_p | Lag time in hours |

If the duration of the required unit hydrograph is significantly different from that specified by Equation (7.69) the following relationship could be used to



relate the effective rainfall t_R in hours to the lag time t_{pR} in hours and peak discharge q_{pR} per unit area in m^3 per sec km^2 .

$$t_{pR} = t_p - \frac{t_r - t_R}{4} \quad (7.74)$$

$$q_{pR} = \frac{q_p t_p}{t_{pR}} \quad (7.75)$$

The base time of the hydrograph t_b in hours can be found using the following relationship between peak discharge q_{pR} and the conversion constant C^3 which equals 5.56:

$$t_b = \frac{C_3}{q_{pR}} \quad (7.76)$$

The width W in hours of the unit hydrograph at a discharge equal to a certain percent of the peak discharge q_{pR} can be calculated using the following equation:

$$W = C_w q_{pR}^{-1.08} \quad (7.77)$$

Where:

C_w 1.22 for the 75 percent width and 2.14 for the 50 percent width

Alameda SUH

As part of a watershed study program completed in 1994, Alameda County, California developed site-specific equations to be used in conjunction with the Snyder unit hydrograph. The site-specific equations are documented in the September 1994 *Hydrologic Modeling Evaluation Summary Report for Alameda County, California* prepared by Alameda County Public Works Agency. There are two SUH equations that were modified as part of the Alameda County watershed study program. The first equation replaces the basin lag t_{pR} and the second equation replaces peaking factor C_p . The site specific equations should be used with caution outside of Alameda County, California.

$$t_{pR} = Kn \left[\frac{LL_c}{\sqrt{S}} \right]^{-0.38}$$

$$K = \begin{cases} 24 & \text{for } L > 1.7 \text{ miles} \\ 15.22 + 21464 L + \frac{8.6981}{L} & \text{for } L < 1.7 \text{ miles} \end{cases} \quad (7.78)$$



Where:

| | |
|----------|---|
| t_{pR} | Lag time in hours |
| K | Watershed coefficient |
| n | watershed factor specific to Alameda County, California |
| L | Length of main stream from the outlet to the divide in km |
| L_c | Length of main stream from the outlet to a point nearest watershed centroid in km |
| S | Average stream slope in ft per mile |
| Note | If $K > 40$ then $K = 40$ |

$$C_p = 0.6e^{0.06(S_o/A)} \quad (7.79)$$

Where:

| | |
|-------|--|
| C_p | Peaking coefficient ($C_p = 0.85$ if C_p from Equation (7.77) is greater than 0.85) |
| S_o | Average overland slope in percent ($S > 5\%$) |
| A | Drainage area in square miles (for drainage area less than 5 square miles use 5) |
| Note | When overland slope $< 5\%$, $C_p = 0.6$ |

User defined Hydrograph



MIKE 1D engine also accepts user defined hydrograph (only available from MIKE 11 interface).

The user must specify the dimensionless flow in a time series with “Dimensionless factor” type. The calendar of the time series must be Relative temporal axis. ■

Calculation Time Step

If the SCS hydrographs are used, SCS suggests the calculation time step to be selected as 22% of the lag time and that it should not exceed 27% of the lag time.



7.7 Combined Rainfall Runoff models



The runoff from a number of catchments, constituting parts of a larger catchment, can be combined into a single runoff series. Each of the sub-catchments must be specified separately by name, model type, parameters etc. The combined catchment can be defined only after the sub-catchments have been created. The combined catchment is defined in the group for combined catchments, which is activated when selecting combined catchment. The sum of the contributing areas of the sub-catchment has to match the area of the combined catchment.

The runoff from the combined catchment is calculated by applying a contributing factor to the runoff of each contributing catchments. The factor corresponds to the contributing area of the sub-catchment compared to the entire area of the combined catchment.

For example the Combined catchment has an area of 100 km², Catchment A of 300 km² and Catchment B of 400 km². However Catchment A contributes only to 60 km² and Catchment B to 40 km² in the Combined catchment. Hence the contributing factor for Catchment A and Catchment B will be respectively 0.2 (= 60/300) and 0.1 (= 40/400).

7.8 Parameters in the INI files

Table 7.12 Parameters in the INI files

| Parameter Name | Default Value | Unit | Available from |
|---------------------------|---------------|------|----------------|
| RUNOFF_A_INITLOSS_RECOVER | 0.00005 | m/h | MU |
| RUNOFF_B_DRYDEPTHMM | 0.001 | mm | MU |
| RUNOFF_B_LOW_FLOW | 0.0001 | mm | MU |
| RUNOFF_B_INITLOSS_RECOVER | 0.00005 | m/h | MU/M11 |
| RUNOFF_B_DT_DRY | 12 | h | MU |
| RUNOFF_B_EVAPORATION | OFF | | MU |
| NL_CONCEPT_DRYDEPTH | 0.001 | mm | MU |
| RUNOFF_C_INITLOSS_RECOVER | 0.00005 | m/h | |



7.9 Input Data

7.9.1 Precipitation

The surface runoff is generated under the impact of precipitation. The precipitation (rainfall) is specified in form of time series, i.e. as a sequence of measured or synthetic values for rainfalls with time and date labels.

Precipitation time series can be specified as intensity (a constant intensity since the previous entry) or as the rain depth (accumulated since the previous entry). The time series for rainfall should contain one of the following Item types:

- Rainfall (A or SA)
- Rainfall depth (A or SA)
- Rainfall intensity (I, BS or FS)
- Rainfall rate (I, BS or FS)

Different rain time series can be applied to the different catchments in the current model set-up, i.e. spatially distributed rain can be simulated. This can be achieved automatically by associating the rain gauge co-ordinates with the time series. The closest rainfall time series is geographically allocated to the specific catchments. Alternatively, individual explicit allocation of specific time series to specific catchments can be applied. There are several ways of adding a rainfall as boundary condition to the catchments:

- Individual: the rain time series is directly link to a specific catchment for a given period
- List: the rain time series is applicable to several for a given period
- Global: it is possible to add a rain time series as a “global”. This rain will applicable for all catchments that don’t have already a rain time series given as individual or as a list. It is also possible to add several “global” rain to the model if they are geo-located. Then the engine will apply the closest rain to each catchment that don’t have individual or list types of rain. It is not allowed to have more than one rain boundary not geo-located in the model

The rain time series can have irregular intervals between the subsequent values. The computational time step for runoff computations is not conditioned by the resolution of the rain time series.

The runoff models calculate the rain intensity for each particular time step, so that the rain volume applied by the model in the time interval covered by the current time step remains preserved, i.e. the applied volume is equal to the volume contained in the same interval of the input data.



7.9.2 Evaporation

For most of the models, it is not required to specify a time series for the evaporation, a default value will be applied (see the specific models for more details).

However if a time series is specified, it has to be of one of these types:

- Evaporation (accumulated)
- Evaporation rate (instantaneous)
- Evapo-transpiration (instantaneous)

7.9.3 Temperature

A temperature is required when using the snow module.

The only type that can be specified is:

- Temperature (I)

7.9.4 Catchment discharge and load

The only type that can be specified is:

- Discharge (I)

7.9.5 Time series data types

Instantaneous (I): The values are representative at one precise instance of time.

Backward Step (BS): The values are representative of the average value over one time step, from the previous time step to this time step. This is what is called Mean_Step_Accumulated in the DFS system

Forward Step (FS): The values are representative of the average value over one time step, from this time step to the next time step. This is what is called Reverse_Mean_Step_Accumulated in the DFS system

Accumulated (A): The values are representative of successive accumulation of values since the start of the time series. First values in the time series must be zero.

Step Accumulated (SA): The values are representative of accumulation over one time step. For example, rainfall can be measured in a step-accumulated fashion. We start measuring rainfall at 10:00:00 by setting up a recipient. At 11:00:00 the value of 10 is registered and the recipient is emptied. At 12:00:00 the same process but with a value of 15 and so on. In the time



series we get the value 10 at time step 11:00:00 and the value 15 at time step 12:00:00 and so on.

7.10 Application of 2D Grid Data

Weather RADAR data in the form of 2D raster grid time series are more and more available for hydrological modelling applications, especially rain data.

Gridded data in the form of dfs2 data is supported for all catchment types. Each catchment requires a set of weights on the form shown in Table 7.13 below.

Table 7.13 Example of catchment weights

| Catchment | i | j | Weight |
|-----------|---|---|--------|
| A | 2 | 1 | 0.3 |
| A | 2 | 2 | 0.5 |
| A | 3 | 2 | 0.2 |
| B | 3 | 4 | 1 |

The time series value for the catchment is the weighted value, i.e. assuming the grid cell at position (i,j) has the value $r_{i,j}$ then the time series value r will be

$$r = \sum_{i,j} w_{i,j} \cdot r_{i,j} \quad (7.80)$$

The weights for each catchment must sum to 1.

The user can specify the catchment weights explicitly. If weights are not specified explicitly, the weights will be calculated automatically using the following approach:

- **Intersecting area:** For small catchments, weights are calculated based on the intersecting area of the polygon and the grid cell. The weight is the fraction of the intersecting area compared to the entire catchment area.
- **Grid cell center:** For larger catchments, weights are calculated based on whether the center of the grid cell is inside the catchment polygon. Assuming there are nc grid cell centers inside the catchment polygon, the weight for each grid cell is $1/nc$

The approach based on intersecting areas is the most precise, however it is computationally expensive to calculate weights for large catchments and big grids. For performance reasons the approach based on grid cell centers is applied for larger catchment. A catchment is considered "larger" when the



area of the catchment is more than 10 times the area of the grid cell, and there are more than 5 grid cell centers inside the catchment polygon.

In Figure 7.16 below, for the intersecting area approach, all grid cells with a cross marker will contribute to the weighted value. For the grid cell center approach, only the 10 grid cells with a cross marker inside the catchment polygon will contribute to the weighted value. This catchment is not considered "larger" because its area is less than 10 times the grid cell area, so the precise intersecting area approach will be used for this catchment.

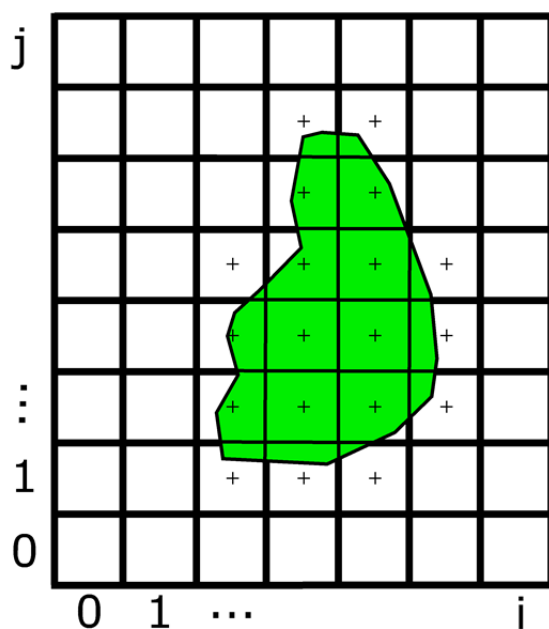

Figure 7.16 Illustration of approach

7.11 Additional Flow and Catchment Discharge

7.11.1 Additional flow

An additional flow can be specified as a discharge. It will be included in the total runoff of the catchment.

The additional flow is specified as a constant value from MIKE 11 and MIKE+.



7.11.2 Catchment discharge

Catchment discharges can be specified as boundary conditions for a catchment.



MOUSE: named dry weather flow

There are 3 ways of specifying DWF from MIKE+:

1. Constant: Average (m^3/s)
2. Cyclic
 - Average (m^3/s)
 - Catchment Area based ($\text{m}^3/\text{s}/\text{m}^2$)
 - Population Equivalent based ($\text{m}^3/\text{s}/\text{PE}$)
3. Time series
 -



MIKE 11: Load based on inhabitants

Catchment discharge is specified as load based on inhabitants (PE). An additional time series for load is specified on the time series, when the flow is based on load based on inhabitants ($\text{PE} > 0$). ■

7.11.3 Total load

The total load of the catchment includes the additional flow and the catchment discharge.



7.12 Nomenclature

| | |
|----------------------|--|
| A | contributing catchment area, (m ²) |
| A_{tot} | total catchment area (m ²) |
| B | runoff width, (m) |
| I, S | surface slope, (-) |
| $I_E(t)$ | evaporation loss at time t , (ms ⁻¹) |
| $I_{PE}(t)$ | potential evaporation loss at time t , (ms ⁻¹) |
| $I_I(t)$ | infiltration loss at time t , (ms ⁻¹) |
| $I_{\text{ICUM}}(t)$ | cumulative infiltration loss at time t_p , (m) |
| $I_S(t)$ | surface storage loss at time t , (m) |
| $I_H(t)$ | Horton's infiltration capacity at time t , (ms ⁻¹) |
| $I_W(t)$ | wetting loss at time t , (m) |
| I_{Imax} | maximum infiltration capacity, (ms ⁻¹) |
| I_{Imin} | minimum infiltration capacity, (ms ⁻¹) |
| $I(t)$ | actual precipitation intensity at time t , (ms ⁻¹) |
| $I_{\text{eff}}(t)$ | effective precipitation intensity at time t , (ms ⁻¹) |
| K_a, K_h | time factor (Horton's characteristic soil parameter) for wetting and drying conditions, respectively |
| M | Manning number, (m ^{1/3} s ⁻¹) |
| $Q(t)$ | runoff, discharge, (m ³ s ⁻¹) |
| t | time, (s) |
| t_c | concentration time, (s) |
| t_p | equivalent time, for use with Horton's equation (s) |
| $\Delta t, dt$ | simulation time step, (s) |
| $Y(t)$ | precipitation depth accumulated on the catchment surface at time t , (m), |



| | |
|----------|---|
| $y_R(t)$ | runoff depth, i.e. precipitation depth accumulated on the catchment surface at time t , (m), reduced by wetting and surface storage depth (m) |
| y_S | surface storage depth (m) |
| y_W | wetting depth (m) |
| dy_R | change in runoff depth, (m) |





8 Stormwater Quality (SWQ)

8.1 Introduction

Stormwater Quality (SWQ) module applies surface pollution to catchment runoff. Surface pollution is specified as a special type of runoff model boundary condition with Water Quality (WQ) boundary properties specifying the quantities and dynamics of stormwater pollution.

SWQ supports separate definitions of stormwater pollution for fast surface runoff contributions and for slow RDI/NAM runoff contributions from catchments.

As any other catchment boundary condition, SWQ boundary condition can be spatially uniform (i.e. applied for all catchments) or spatially distributed (applied on a selection or individual catchment).

The following methods are supported for computation of stormwater water quality:

1. Simple concentration
2. Tabular concentration
3. Build-up/Wash-off
4. Event mean concentration (EMC)

Method 1 applies a concentration directly to the runoff from the catchment. The applied concentration can be specified as constant or cyclic or it can be based on an arbitrary time series. In this method, the concentration is independent of the runoff.

Method 2 applies a concentration of pollutant specified as a tabulated function of runoff intensity (i.e. specific runoff).

Note that Method 1 and Method 2 assume unlimited supply of pollutants on the catchment surface. These should be applied with care and only in appropriate cases.

Methods 3 and 4 simulate the build-up of pollutants or sediments on the catchment surface and wash-off of this pollution by mechanical action of rainfall. These methods are also referenced to as SWQ advanced methods.



8.2 Build-up/Wash-off method

8.2.1 Build-up of pollution on the catchment

During dry weather periods, pollution or sediments accumulate on the surface of urban catchments. The most common formulation of this process is to assume that the build-up is a linear or an exponential function of time. The choice between the two formulations is not straightforward, due to insufficient experimental results.

The linear build up function is given as

$$\frac{dM}{dt} = A_c \quad \text{for} \quad M < M_{max} \quad (8.1)$$

$$\frac{dM}{dt} = 0 \quad \text{for} \quad M \geq M_{max} \quad (8.2)$$

and the exponential build-up function is given as

$$\frac{dM}{dt} = A_c - D_{rem}M \quad \text{with} \quad M_{max} = \frac{A_c}{D_{rem}} \quad (8.3)$$

Here:t

t = time in days

M = accumulated mass per area of pollutants at time t , (kg/ha)

M_{max} = maximum accumulated mass per area of pollutants on the catchment, (kg/ha)

A_c = daily accumulation rate, (kg/ha/day)

D_{rem} = removal coefficient, (1/ha/day)

The coefficient D_{rem} represents the removal of pollution from the surface by various mechanisms (for example by wind, traffic, street sweeping, biological and chemical degradation) - all except wash-off. The accumulated mass M will increase until a limit $M_{max} = A_c / D_{rem}$.

The initial value of pollutant mass on catchment surface is determined by building-up mass from 0 for $ADWP_{ini}$ time (duration of antecedent dry weather period before the first event in the simulation).

An example of the two build-up formulations is shown in Figure 8.1.



When the sediments are being built up in the model, it is possible to attach pollutants to these sediments. The mass of the pollutant $M_{i, \text{Pollutant}}$ is related to the mass of the sediment M_{Sediment} by a simple fraction $f_{i, PS}$

$$M_{i, \text{Pollutant}} = f_{i, PS} M_{\text{Sediment}} \quad \text{with} \quad \sum_i f_{i, PS} \leq 1 \quad (8.4)$$

The difference between pollutants and sediments from the modelling perspective is that sediments are used as an input to the Sediment Transport (ST) module and pollutants are used as an input to the Advection Dispersion (AD) module.

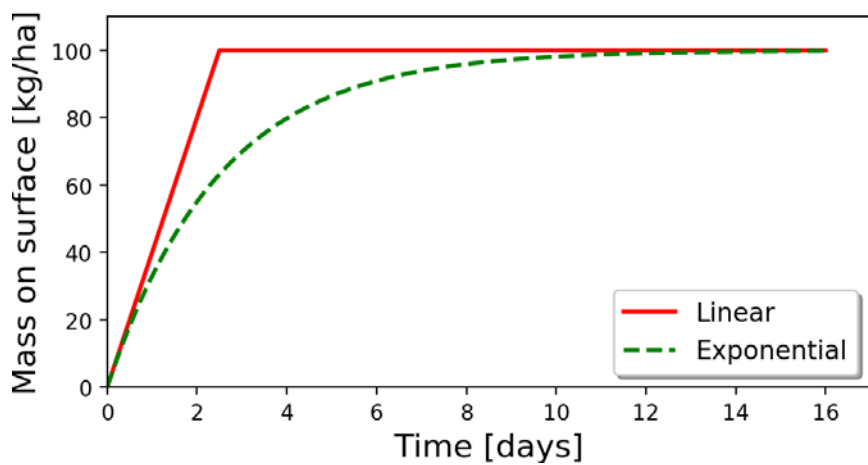

Figure 8.1 An example of the linear and the exponential build-up function. The values of parameters are: $A_c = 40$ kg/ha/day, $M_{\text{max}} = 100$ kg, $ADWP_{\text{ini}} = 0$ h.

8.2.2 Wash-off of pollution by rainfall

Wash-off of pollution during a rain event can be divided into two processes: erosion by raindrops and erosion by overland flow. Only the erosion by raindrops is considered in this model. Erosion by raindrops is governed by several parameters. The most important are: rainfall intensity, rainfall depth, rainfall duration, raindrop size, catchment topography, particle characteristics and vegetation. However, parameters such as raindrop size and rainfall depth are rarely available, so a simpler approximation has been adopted in the model. This approximation states that the raindrop erosion is a function of the rain intensity and a detachment rate. The equation for the detachment by rainfall can be written as (ref /39/):

$$\frac{dM_{rem}}{dt} = D_r \left(\frac{i_r}{i_d} \right)^n \quad (8.5)$$



where

dM_{rem}/dt = pollutant mass washed off by the rain per unit of time, (kg/ha/day)

D_r = detachment coefficient for rainfall, (kg/ha/day)

i_r = rainfall intensity, (mm/h)

i_d = rain intensity constant, (25.4 mm/h)

n = exponent (default value 2)

The default value $n=2$ assumes that kinetic energy of raindrops is causing the detachment of the pollutant. Kinetic energy is assumed to be quadratically related to rainfall intensity. The rainfall intensity has dimension of velocity, and it is known that kinetic energy E of water is proportional to square of flow velocity v (i.e., $E \propto v^2$).

Only the dissolved pollution is routed together with the runoff. The routing happens based on a catchment model specified. If there are water losses in the catchment model, it is assumed that the pollution is not lost and is extracted back to the catchment surface.

8.3 Event Mean Concentration (EMC) method

In the EMC method, a C_{EMC} concentration is applied to the runoff of catchment during a rain event. The pollution builds up in the same way as for Build-up/Wash-off method. The difference is that the wash-off is not considered as a dynamic process related to rainfall intensity but instead to the actual rainfall volume. The following is assumed:

- All pollution accumulated on the catchment surface is washed off by a rainfall event. This assumption is valid if the pollutant concentration does not exceed a specified maximal concentration C_{max} . In case of exceedance, the pollutant concentration is set to C_{max} , and the residual surface pollution remains on the catchment surface.
- Concentration of pollutant in runoff is constant throughout the rainfall event and is calculated as ratio between the available pollutant mass and rainfall event volume. The water volume in a rain event is determined by summing up all the rainfall over the event duration:

$$V = A \int_{t_{start}}^{t_{end}} i_r(t) dt \quad (8.6)$$



where

V = water volume in the rain event

A = area of the catchment

i_r = rainfall intensity

t_{start} = start time of the rain event

t_{end} = end time of the rain event

The EMC is determined as:

$$C_{EMC} = \max\left(C_{max}, \frac{M_{start}}{V}\right) \quad (8.7)$$

where

C_{EMC} = pollutant event mean concentration

C_{max} = maximum pollutant concentration allowed in the rain event

M_{start} = mass of pollutant at the start of the rain even

Note that during the rain event, the pollutant mass continues to build up.

Calculation of C_{EMC} based on the rain volume and its application to the runoff is inherently an approximation and introduces a small error in the calculated C_{EMC} . As runoff volume is always smaller than or equal to rain volume, the pollutant mass included in the runoff will in most cases be smaller than the available mass on the catchment surface, the difference being retained on the catchment surface. In a continuous simulation with consecutive events, the method remains mass conserving.

8.3.1 Definition of rain events

A rain event in the EMC method is characterized by two user-specified parameters:

i_t = event threshold, (mm/h)

$ADWP_{min}$ = minimal Antecedent Dry Weather Period (ADWP), (h)



Two rain intervals separated by a dry interval are considered as one continuous rain event, if the dry interval between two wet weather periods is less than the specified $ADWP_{min}$.

The rain event is included in the simulation when the peak rain intensity exceeds the specified event threshold i_t .

8.3.2 Pollutant wash-off routing

The wash-off of pollutants happens during the rain event, but the pollutants follow the runoff routing over the catchment surface and are delayed like the rain water. I.e. pollutant runoff from a catchment continues also in the period after the rain has stopped and until the end of the runoff.



9 Data Assimilation in MIKE 1D

Data assimilation is a technique for combining any measurements of the state of the system with the model dynamics in order to improve the knowledge of the system. The data assimilation module in MIKE 1D can be used for assimilation of water level and discharge measurements in the hydrodynamic model and for assimilation of concentration measurements in the advection-dispersion model. Furthermore, the data assimilation module can be used for uncertainty assessment and estimation of model prediction uncertainties.

The data assimilation methods implemented in the MIKE 1D DA module belongs to the class of sequential algorithms. In this case a sequential updating of the model solution is performed during a forward model integration in which the model forecast and the data are melded according to a specific melding scheme. Two different melding schemes based on the Kalman filter are available in MIKE 1D:

- Ensemble Kalman filter
- Constant weighting function method

The ensemble Kalman filter is based on a stochastic model formulation in which model uncertainties are quantified and propagated through the model. This formulation also allows for general uncertainty assessment, i.e. without assimilation of measurements. The constant weighting function method is a deterministic approach that does not explicitly address model uncertainties. Both methods can be formulated in a general filtering framework.

The data assimilation module can be used either in hindcasting mode for process studies and design purposes or as part of an operational forecasting system. In either case, the module provides an improved estimate of the state of the system which is consistent with the observed data. In an operational setting the data assimilation module is used for updating the state of the system prior to the time of forecast, and hence providing improved initial conditions for the forecast. After the time of forecast the model can be corrected using forecasts of model errors.

Application examples of the MIKE 11 data assimilation module can be found in Hartnack and Madsen /21/, Madsen et al. /26/ and Madsen and Skotner /27/.

These example results are representative for results produced by the MIKE 1D data assimilation module.

The same principles has been used in both the MIKE 11 and the MIKE 1D data assimilation module.

They do, however, not use the same random number generator thus giving some differences in the results using the Ensemble Kalman filter especially when using a small number of ensembles.



9.1 Data assimilation framework

The MIKE 1D model can be described in a deterministic, discrete dynamical system setting as

$$\mathbf{x}_{k+1} = \Phi(\mathbf{x}_k, \mathbf{u}_k) \quad (9.1)$$

where

x_k is the state variables of the system at time step k in terms of h - and Q -points for each branch in the river system and concentration components in the advection-dispersion model (if used).

\mathbf{u}_k is the forcing terms of the system incorporating all boundary conditions, lateral inflow/outflow and possible wind fields.

$\Phi(\cdot)$ is the model operator representing the numerical scheme of MIKE 1D (one time-step-ahead prediction operator).

It is assumed that water level, discharge and concentration measurements are available at one or more locations in the modelled river system. This is formulated in the measurement equation

$$\mathbf{z}_k = \mathbf{C}_k \mathbf{x}_k \quad (9.2)$$

where

\mathbf{z}_k is the vector of measurements.

\mathbf{C}_k is a matrix that describes the relation between measurements and state variables, i.e. a mapping of state space to measurement space.

The data assimilation process is a succession of two steps. First, the model is employed to issue a forecast, and then the observed data are meld with the forecast to provide an updated state (analysis step). The analysis step is chosen to be a linear combination of the data and the model, i.e.

$$\mathbf{x}_k^a = \mathbf{x}_k^f + \mathbf{G}_k (\mathbf{z}_k - \mathbf{C}_k \mathbf{x}_k^f) \quad (9.3)$$

where

\mathbf{x}_k^f is the forecast state vector obtained from Eq. (9.1).

\mathbf{x}_k^a is the analysed or updated state vector.

\mathbf{G}_k is a weighting matrix (gain matrix).



The vector $(z_k - C_k x_k^f)$, denoted the innovation vector, includes the differences between the measurements and their model forecasted equivalents. If the measurements are independent, a sequential update procedure can be used that processes one measurement at a time

$$x_k^a(j) = x_k^a(j-1) + g_{k,j}(z_{k,j} - x_k^a(j-1)), x_k^a(0) = x_k^f, j = 1, 2, \dots, p \quad (9.4)$$

where

p is the number of measurements.

$z_{k,j}$ is measurement No. j .

$(z_{k,j} - x_k^a(j-1))$ is the innovation in measurement point No. j after processing $j-1$ measurements.

$g_{k,j}$ is a weighting vector (gain vector) corresponding to measurement No. j that describes how the innovation $(z_{k,j} - x_k^a(j-1))$ is distributed on the state vector.

The shape of the gain reflects the correlation between the measurement and nearby points, taken into account measurement and model uncertainties. If the gain in the measurement position is equal to 1, measurements are assumed to be perfect. The smaller gain is chosen the larger uncertainty is assumed in the measurement compared to the model uncertainties.

The formulation of the gain matrix in Eq. (9.3) or the gain vectors in Eq. (9.4) is the most essential part of the filtering scheme, and the different schemes mainly differ from each other in the way the gains are calculated. The most comprehensive linear melding scheme is the Kalman filter where the gains are determined based on a minimisation of the expected error of the analysed state vector in terms of the errors of both model dynamics and data. In this case the gains are determined sequentially based on a dynamical evolution of the forecast covariance matrix of the state vector.

For high-dimensional systems, as considered here, the propagation of the covariance matrix is the main bottleneck, in most cases imposing an unacceptable computational burden for real-time applications. The ensemble Kalman filter (EnKF) presented by Evensen /18/ approximates the error covariance modelling by an ensemble of state vectors that are propagated according to the model equation (9.1). This approximation reduces significantly the computational burden.

Experiences with the EnKF shows that the computational requirements for obtaining a proper representation of the covariance matrix are of the order of 100 model runs, which may be too expensive in real-time applications. The constant weighting function method developed by Madsen and Skotner /27/ is based on predefined gain vectors that are assumed constant in time. In this

case the filtering update is only slightly more expensive than a normal model run.

9.2 Ensemble Kalman filter

The Kalman filter is based on a stochastic formulation of the model equation (9.1) and measurement equation (9.2). By including possible errors on the forcing terms the system gets the following stochastic formulation:

$$\mathbf{x}_{k+1} = \Phi(\mathbf{x}_k, \mathbf{u}_k + \varepsilon_k) \quad (9.5)$$

where

ε_k is a vector containing the model error of the forcing terms.

The stochastic representation of the measurements is given by:

$$\mathbf{z}_k = \mathbf{C}_k \mathbf{x}_k + \eta_k \quad (9.6)$$

where

η_k is a random measurement error vector with zero mean and covariance matrix \mathbf{R}_k .

The uncertainty of the model forecast is described by the covariance matrix \mathbf{P}_k^f . The Kalman gain to be used in the update equation (9.3) is given by

$$\mathbf{G}_k = \mathbf{P}_k^f \mathbf{C}_k^T (\mathbf{C}_k \mathbf{P}_k^f \mathbf{C}_k^T + \mathbf{R}_k)^{-1} \quad (9.7)$$

which depends on the model and measurement covariances. The model covariance expresses how the innovation vector should be distributed on the state vector, and the relation between the model and measurement covariances expresses how much weight should be put on the measurement. The smaller measurement variance as compared to the model variance, the more weight is put on the measurement.

A major shortcoming of the above formulation is the assumption that the covariance matrix \mathbf{P}_k^f is known a priori. For non-linear and high-dimensional systems such as MIKE 1D the evaluation of the covariance matrix requires huge computational costs and storage requirements, and hence makes the filtering infeasible for real-time applications.

In the EnKF, the covariance matrix is represented by an ensemble of possible state vectors. Each of these vectors is propagated according to the dynamical system subjected to model errors cf. Eq. (9.5), and the resulting ensemble then provides estimates of the forecast state vector and covariance matrix. In the measurement update, the Kalman gain matrix is applied for each of the



forecast state vectors. To account for measurement errors, the measurements are represented by an ensemble of possible measurements. The resulting updated sample provides estimates of the updated state vector and covariance matrix.

The EnKF algorithm is summarised below. It is assumed that measurement errors are uncorrelated i.e. the covariance matrix \mathbf{R}_k is a diagonal matrix

$$\mathbf{R}_k = \text{diag}[\sigma_1^2, \dots, \sigma_p^2] \quad (9.8)$$

and hence the sequential updating algorithm in Eq. (9.4) can be applied.

Let there be given a set of M state vectors $\mathbf{x}_{j,k}^f$, where $j=1, \dots, M$ and k is the time step index.

1. Each member of the ensemble is propagated forward in time according to the stochastic dynamical system given by Eq. (9.5). For each member of the ensemble the model error is drawn from a Gaussian distribution with zero mean and known covariance.
2. The forecast of the state vector is then estimated as the mean of this ensemble:

$$\bar{\mathbf{x}}_k^f = \frac{1}{M} \sum_{j=1}^M \mathbf{x}_{j,k}^f \quad (9.9)$$

3. An estimate of the covariance matrix is found according to:

$$\mathbf{P}_k^f = \frac{1}{M-1} \mathbf{S}_k^f (\mathbf{S}_k^f)^T, \quad (9.10a)$$

$$\mathbf{S}_{j,k}^f = \mathbf{x}_{j,k}^f - \bar{\mathbf{x}}_k^f, \quad (9.10b)$$

4. Each of the ensemble state vectors are updated sequentially using Eq. (9.4). The gain vector for measurement No. i is given by:

$$\mathbf{g}_k^i = \frac{1}{\mathbf{c}_k^i \mathbf{P}_{k,i-1}^a (\mathbf{c}_k^i)^T + \sigma_i^2} \mathbf{P}_{k,i-1}^a (\mathbf{c}_k^i)^T \quad (9.11)$$

In the above sub-/super-script i is a running index indicating elements corresponding to the i 'th update using the i 'th measurement \mathbf{z}_k^i . The term \mathbf{c}_k^i is the i 'th row of the information matrix \mathbf{C}_k described earlier.



5. The updated state vector and covariance matrix are estimated as:

$$\bar{\mathbf{x}}_k^a = \frac{1}{M} \sum_{j=1}^M \mathbf{x}_{j,k}^a, \mathbf{P}_k^a = \frac{1}{M-1} \mathbf{S}_k^a (\mathbf{S}_k^a)^T \quad (9.12)$$

In the implementation of the EnKF the covariance matrix \mathbf{P}_k is never calculated. All calculations are based on \mathbf{S}_k .

When no data are available for updating, only steps 1-3 are carried out. This is the approach taken in MIKE 1D DA when performing uncertainty assessment and making a stochastic or ensemble forecast.

9.2.1 Model errors described by auto-regressive processes

The model errors are defined by auto-regressive processes of first order. Thus, for each uncertain boundary condition $l = 1, 2, \dots, L$ the model errors are described by

$$\varepsilon_{i,k+1}^l = \phi_l \varepsilon_{i,k}^l + \delta_{i,k+1}^l, \quad i = 1, 2, \dots, M \quad (9.13)$$

where $\delta_{i,k+1}^l$ is randomly drawn from a Gaussian distribution with zero mean and user defined standard deviation $\sigma_{d,j}$. Furthermore, all $\delta_{i,k+1}^l$ are assumed to be uncorrelated. It should be emphasised that to ensure that the errors do not grow without limit the absolute value of the regression coefficients ϕ must be less than unity.

By using an auto-regressive description the model error has some memory that is propagated as part of the model forecast. In this case the model state is augmented with the model errors that are updated as part of the Kalman filter update scheme. In forecast mode, the model errors at the time of forecast are phased out according to the exponential decay defined by the auto-regressive process.

9.3 Constant weighting function

In the constant weighting function method the gain functions in the update equation (9.4) are assumed to be constant. Three different gain functions are



assumed, respectively, a constant (g_1), a triangular (g_2), and a mixed exponential (g_3) distribution

$$g_1(\xi) = A, \xi_{US} \leq \xi \leq \xi_{DS}$$

$$g_2(\xi) = \begin{cases} A \frac{\xi - \xi_{US}}{\xi_{MP} - \xi_{US}}, & \xi_{US} \leq \xi \leq \xi_{MP} \\ A \frac{\xi_{DS} - \xi}{\xi_{DS} - \xi_{MP}}, & \xi_{MP} \leq \xi \leq \xi_{DS} \end{cases} \quad (9.14)$$

$$g_3(\xi) = A \exp\left(-\frac{1}{2}\left(\frac{\xi'}{1/3}\right)^2\right) = \begin{cases} \xi' = \frac{\xi_{MP} - \xi}{\xi_{MP} - \xi_{US}}, & \xi_{US} \leq \xi \leq \xi_{MP} \\ \xi' = \frac{\xi - \xi_{MP}}{\xi_{DS} - \xi_{MP}}, & \xi_{MP} < \xi \leq \xi_{DS} \end{cases}$$

where

$g(\xi)$ is the gain value at the river chainage ξ .

ξ_{US} is the upstream bound for the gain function.

ξ_{DS} is the downstream bound for the gain function.

ξ_{MP} is the measurement point.

A is the gain amplitude.

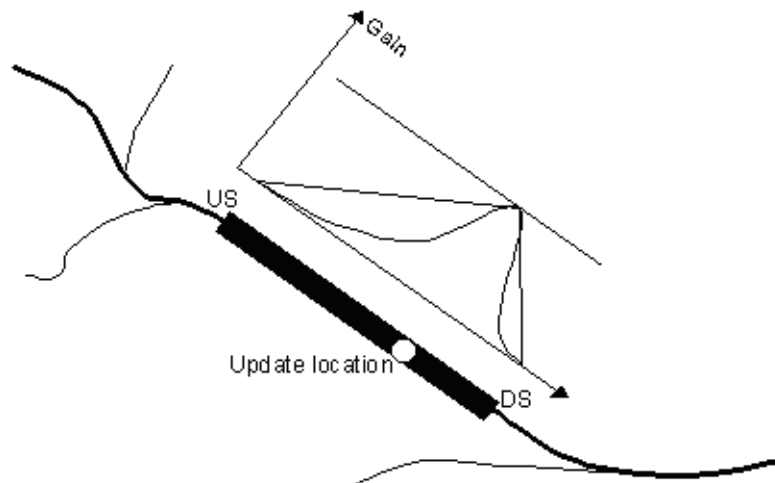

Figure 9.1 Definition of gain function for a measurement (update) location. Note that updates cannot take place across river junctions

The definition of the gain function is illustrated in Figure 9.1. The amplitude should reflect the confidence of the observation as compared to the model forecast; that is, if $A = 1$ the measurement is assumed to be perfect, whereas for smaller A less emphasis is put on the measurement as compared to the model forecast. The distribution and the bounds of the gain function should reflect the correlation between the model forecast error at the measurement location and the errors at nearby grid points.

The procedure updates the parts of the state vector that correspond to the measurement variable (e.g. if water levels are measured the water level grid points are updated) using the sequential algorithm in Eq. (9.4). The other parts of the state vector are implicitly updated according to the numerical scheme in the next time step.

9.3.1 Error forecast modelling

The filtering procedure described above can be applied to update the state of the river system up to the time of forecast (or as long as measurements are available). This updated state can then be used as initial conditions for a model forecast. In this case, however, the forecast skills of the model will be limited to a time horizon where the initial conditions are washed out. To keep the model on the "right track" for a longer period the filtering procedure is here combined with error forecasts at the measurement points.

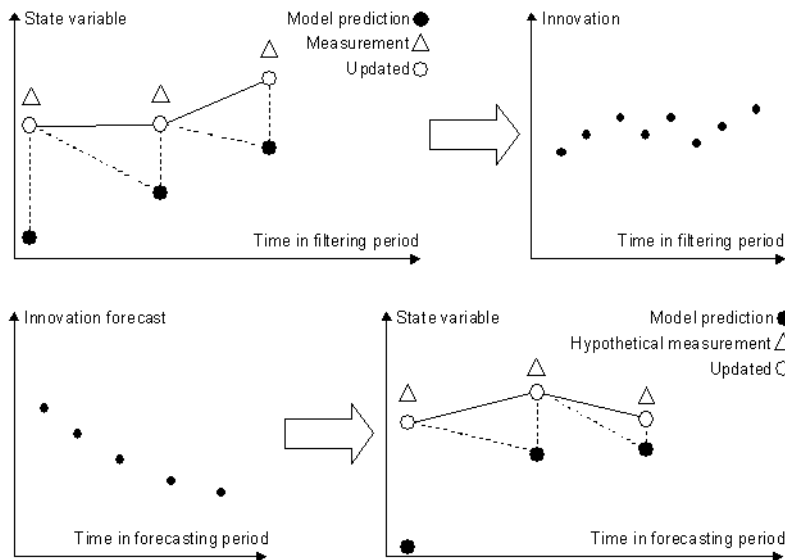

Figure 9.2 Illustration of the combined filtering and error forecast procedure

The principle of this combined approach is illustrated in Figure 9.2. At each update time step in the filtering period (prior to the time of forecast), the model innovation is acquired at all update locations. For each update location this gives rise to a time series of innovations that covers the filtering period up to the time of forecast (or the time of the last measurement). At the end of the filtering period, an error forecast model defined at each update location is then used to propagate the innovation in the forecasting period and update the affected state variables accordingly using the filtering algorithm in Eq. (9.4).

The error forecast model can be defined as a general linear or non-linear model with a one-step ahead prediction that depends on the previous innovations ($\varepsilon_{k-1}, \varepsilon_{k-2}, \dots$), the forecasted model state at the present time step (x_k^f), the previous updated model states ($x_{k-1}^a, x_{k-2}^a, \dots$), and the present and previous model forcings (u_k, u_{k-1}, \dots)

$$\varepsilon_k = f(\varepsilon_{k-1}, \varepsilon_{k-2}, \dots, x_k^f, x_{k-1}^a, x_{k-2}^a, \dots, u_k, u_{k-1}, \dots) \quad (9.15)$$

Equation (9.15) is used recursively by substituting observed innovations with forecasted values.

In the implementation, an equation parser is used that facilitates an easy and flexible definition of error forecast models such as auto-regressive, moving average models or other linear or non-linear functional forms based on common mathematical operators. Thus, it is possible to define a wide range of error forecast models tailored to the local nature of the model error at each update location.



In order to ensure a fast, accurate and objective derivation of the error forecast models, fully automatic parameter estimation techniques have been incorporated. On the basis of a user-defined time window in the filtering period prior to the time of forecast, the parameters of the error forecast model are estimated. The error forecast models are updated when a new forecast is to be issued using time series of the most recent innovations. This allows the error forecast models to adapt from one forecast to the next to the physical conditions prevailing at the time of forecast without any need for calibration or user intervention in general. In the case of a linear error forecast model, the model parameters are estimated using least squares regression techniques, whereas the shuffled complex evolution (SCE) algorithm (Duan et al. /15/) is applied for the parameter optimisation in the case of a non-linear model.



10 Long Term Statistics (LTS)

10.1 Introduction

The Long-Term Statistics (LTS) module converts a simulation covering a long, continuous historical period into a series of shorter simulation intervals, called jobs. Each job contains a rain event considered to be relevant in the actual analysis. Time extent of these jobs (Start and End time) is determined by an automated analysis of the hydrological and non-hydrological loads, based on user-specified job list criteria. Further on, the extent of these LTS simulation jobs may be extended by user-specified run-time criteria.

During the simulation, the LTS module calculates various event-based (instantaneous and accumulated) and annual (monthly) statistics according to user specified parameters. This section contains a short description of the way statistical events are determined. For more details about LTS module, see MIKE+ Collection System User Guide.

10.2 LTS instantaneous events

An instantaneous LTS event is a local maximum in time of a certain quantity, typically water level or discharge. The LTS module registers only instantaneous events which are found to be independent, i.e. they must fulfill simultaneously the following two criteria:

1. Interevent time criterion ΔT : two successive instantaneous events are independent if the time difference between the two events exceeds ΔT . In other words, a *local maximum* in a time series is an event maximum if there are no larger local maxima within $\pm\Delta T$ of the *local maximum*.
2. Interevent level criterion p ($0 < p < 1$): two successive instantaneous events are independent if the smallest level between the two events becomes smaller than p times the value of the smallest of the two events.

Please note that in some cases criterion 2 needs to be applied with respect to a common zero level for the quantity. For example, for a water level in a node, the zero level would correspond to the node bottom level. In general, to identify events for water levels, the criterion 2 is applied to water depths.

10.2.1 Examples

Figure 10.1 shows several examples of LTS event identification, using the two criteria.

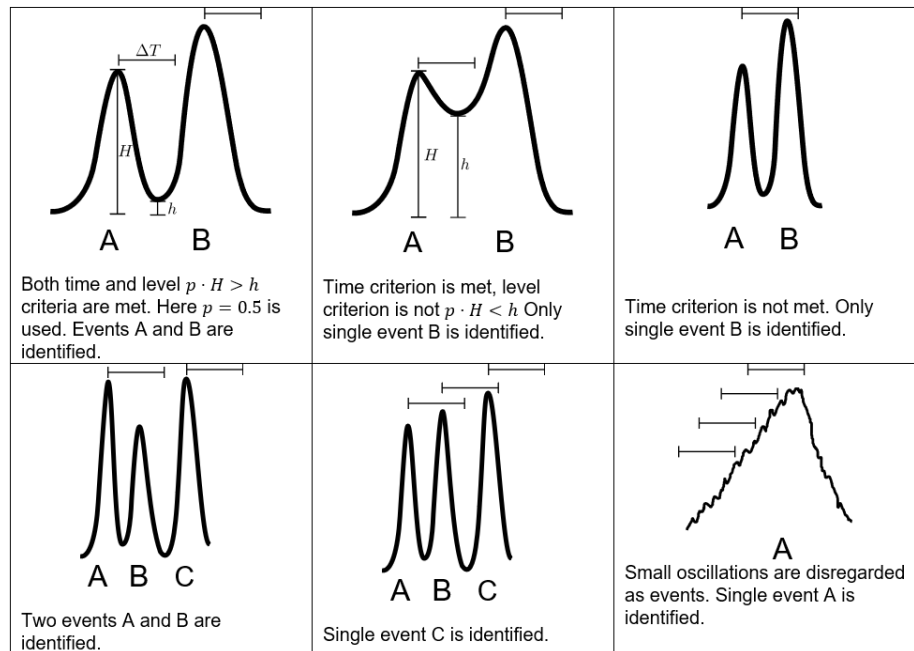

Figure 10.1 Examples of LTS event identification

10.3 LTS accumulated events

The above description and criteria do not apply for accumulated quantities such as volume, mass etc. For these quantities, independent events are determined exclusively based on the specified interevent time criterion. For example, two overflow volumes are considered as independent if the interevent time with zero overflow is longer than the specified time parameter.

Statistics for accumulated quantities include both the accumulated quantity value during an event and the duration of the event.



11 References

- /1/ Abbott, M.B.: *Computational Hydraulics. Elements of the Theory of Free Surface Flows*. Pitman, 1979.
- /2/ Abbott, M.B. and Basco, D.R.: *Computational Fluid Dynamics, an introduction for engineers*. Longman Scientific & Technical, 1989.
- /3/ Abbott, M.B. and Ionescu, F.: *On the numerical computation of nearly-horizontal flows*. J.Hyd.Res., 5, 1967, pp. 97-117.
- /4/ Abbott, M.B. and Refsgaard, J.C. (eds): *Distributed Hydrological Modelling*, Kluwer Academic Press, The Netherlands, 321, 1996.
- /5/ Bier, P.E. and Delleur, J.W.: *Hydraulics of single span bridge constructions*. Proceedings of the American Society of Civil Engineers, Journal of the Hydraulics Division, 88(HY2), March 1962, 75-108.
- /6/ Bradley, J.N.: *Hydraulics of Bridge Waterways*. Hydraulic Design Series No. 1, Federal Highway Administration, U.S. Department of Transportation, Second Edition, revised March 1978, Washington D.C.
- /7/ Brakensiek, D.L.: *Comments on 'Empirical Equations for some soil Hydraulic Properties' by Roger B. Clapp and George M. Hornberger*, Water Resources Research, 15 (4), 989-990, 1979.
- /8/ Brakensiek, D.L., Engleman, R.L. and Rawls, W.J.: *Variation within texture classes of soil water parameters*, Trans. ASAE, 24, 335-339, 1981.
- /9/ Bretting, A.E.: *Hydraulik, Stationære strømninger*, B Stougaard Jensen, Copenhagen, Denmark, 1960.
- /10/ Carter, R.W.: *Computation of Peak Discharge at Culverts*. U.S. Geological Survey Circular 376, 1957.
- /11/ Chow, V.T.: *Open-Channel Hydraulics*. McGraw Hill, 1959.
- /12/ Cosby, B.J., Hornberger, G.M., Clapp, R.B. and Ginn, T.R.: *A statistical exploration of the relationships of soil moisture characteristics to the physical properties of soils*, Water Resources Research, 20 (6), 682-690, 1984.
- /13/ Cunge, J.A., Holly, F.M., Jr. and Verwey, A.: *Practical Aspects of Computational River Hydraulics*. Pitman, 1980.
- /14/ Cunge, J.A. and Wegner, M.: *Integration numerique des equations d'ecoulement de Barre de Saint-Venant par un schema implicite de differences finies: Application au cas d'une galerie tantot en charge*,



- tantot a surface libre*. La Houille Blanche, No 1, 1964.
- /15/ Duan, Q., Sorooshian, S., Gupta, V., 1992, Effective and efficient global optimization for conceptual rainfall-runoff models, *Water Resour. Res.*, 28(4), 1015-1031.
- /16/ Engelund, F.: *Hydraulic resistance of alluvial streams*. ASCE, Vol. 92, No. Hy. 2, 1966.
- /17/ Engelund, F.A and Pedersen, Fl. Bo: *Hydraulik*, Den Private Ingeniørfond, Danmarks Tekniske Højskole, ISBN 87-87245-64-7 (In Danish)
- /18/ Evensen, G., 1994, Sequential data assimilation with a non-linear quasi-geostrophic model using Monte Carlo methods to forecast error statistics, *J. Geophys. Res.*, 99(C5), 10,143-10,162.
- /19/ Federal Highway Administration: *Bridge Waterways Analysis Model*: Research Report, Report No. FHWA/RD-86/108, July 1986, Washington D.C.
- /20/ Hamil, L.: *Bridge Hydraulics*. E & FN Spon, 1999.
- /21/ Hartnack, J.N., and Madsen, H., 2001, Data assimilation in river flow modelling, 4th DHI Software Conference, 6-8 June, 2001, Scanti-con Conference Centre, Helsingør, Denmark
- /22/ Henderson, F.M.: *Open Channel Flow*. MacMillan, 1966.
- /23/ Li, R.-M., Stevens, M.A. and Simons, D.B.: *Solutions to Green-Ampt infiltration equations*, *J. Irrig. and Drain. Div., Amer. Soc. Civil. Eng.*, 102 (IR2), 239-248, 1976.
- /24/ Lundgren, H. and Jonsson, I.G.: *Shear and velocity distribution in shallow channels*. ASCE, Vol. 90, No. HY1, pp. 1-21, 1962.
- /25/ Madsen, H. ,1999, *Automatic calibration of a conceptual rainfallrun-off model using multiple objectives*, *Journal of Hydrology*, Submitted.
- /26/ Madsen, H., Rosbjerg, D., Damgård, J., Hansen, F.S., 2003, Data assimilation in the MIKE 11 Flood Forecasting system using Kalman filtering, *Water Resources Systems - Hydrological Risk, Management and Development (Proceedings of symposium HS02b held during IUGG2003 at Sapporo, July 2003)*. IAHS Publ. no. 281, 75-81.
- /27/ Madsen, H., and Skotner, C., 2004, Adaptive state updating in real-time river flow forecasting - A combined filtering and error forecast-



- ing procedure, Journal of Hydrology, Submitted.
- /28/ McCuen, R.H., Rawls, W.J. and Brakensiek, D.L.: *Statistical analysis of the Brooks-Corey and Green-Ampt parameters across soil textures*, Water Resources Research, 17, 1005-1013, 1981.
- /29/ MOUSE User Manual and Tutorial, DHI, 1999.
- /30/ Murota, A. and Tada, H.: *Modelling of one-dimensional analysis on the open-channel with a tributary*. 1989.
- /31/ Nash, I.E. and Sutcliffe, I.V.: *River flow forecasting through conceptual models*, Part I, Journal of Hydrology, 10, 282-290, 1970.
- /32/ Nielsen, S.A. and E. Hansen: *Numerical simulation of the rainfall runoff process on a daily basis*. Nordic Hydrology, 4, 171-190, 1973.
- /33/ Pedersen, F.B., Mark, O.: *Headlosses in Storm Sewer Manholes: Submerged Jet Theory*. Journal of Hydraulic Engineering, Vol. 116, No. 11, November 1990.
- /34/ Preissmann, M.A. and Cunge J.A.: *Calculation of Wave Propagation on Electronic Machines*. Proceedings, 9th Congress, IAHR, Dubrovnik, pp. 656-664, 1961.
- /35/ Rawls, W.J., Brakensiek, D.L. and Saxton, K.E.: *Estimation of soil water properties*, Transactions of the ASAE, 25, 1316-1320, 1982.
- /36/ Refsgaard, J.C. and J. Knudsen: *Operational validation and inter-comparison of different types of hydrological models*. Water Resources Research, 32(7), 2189-2202, 1997.
- /37/ Refsgaard, J.C. and Storm, B.: *Construction, calibration and validation of hydrological models*, In: Distributed Hydrological modelling (eds. M.B. Abbott and J.C. Refsgaard), Kluwer Academic Press, The Netherlands, 41-54, 1996.
- /38/ Rijtema, P.E.: *Soil moisture forecasting*, Nota 513, Instituut voor Cultuurtechniek en Waterhuishouding, Wageningen, The Netherlands, 1969.
- /39/ Svensson, G., 1987. Modelling of Solids and Metal Transport from small Urban Watersheds. Chalmers University of Technology, Göteborg, Sweden, 1987.
- /40/ Toch, A.J.: *Discharge Characteristics of Tainter Gates*, Transactions ASCE Paper No. 2739, pp. 290-300, 1953.
- /41/ U.S. Army Corps of Engineers: *Snow hydrology: Summary report*



on snow investigations, 1956.

- /42/ Verwey, A.: *Linkage of Physical and Numerical Aspects of Models Applied in Environmental Studies*. Keynote lecture. In: Proceedings of the Conference on Hydraulics in Civil Engineering. International Conference on Hydraulics in Civil Engineering, 15–17 February 1994, Brisbane, Australia.



APPENDIX A

Hydrodynamic Module





A.1 Deriving the Saint-Venant Equations

The 1D engine approximates the vertically integrated equations of conservation of volume and momentum (the ‘Saint-Venant equations’), which are derived on the basis of the following assumptions:

- the water is incompressible and homogeneous, i.e. without significant variations in density
- the bottom slope is small
- the wave lengths are large compared to the water-depth. This ensures that the flow everywhere can be regarded as having a direction parallel to the bottom, i.e. vertical acceleration can be neglected and a hydrostatic pressure variation along the vertical can be assumed
- the flow is sub-critical

For a rectangular cross section with a horizontal bottom and a constant width, the conservation of mass and momentum can be expressed as follows (in the first instance neglecting friction and lateral inflows):

Conservation of mass:

$$\frac{\partial(\rho Hb)}{\partial t} = -\frac{\partial(\rho Hb\bar{u})}{\partial x} \quad (\text{A.1.1})$$

Conservation of momentum:

$$\frac{\partial(\rho Hb\bar{u})}{\partial t} = -\frac{\partial\left(\alpha'\rho Hb\bar{u}^2 + \frac{1}{2}\rho gbH^2\right)}{\partial x} \quad (\text{A.1.2})$$

where ρ is the density, H the depth, b the width, \bar{u} the average velocity along the vertical and α' the vertical velocity distribution coefficient.

Introducing the bottom slope, I_b , and allowing for the channel width to vary will give rise to two more terms in the momentum equation. These terms describe the projections in the flow direction of the reactions of the bottom and side walls to the hydrostatic pressure.



The momentum equation now becomes:

$$\begin{aligned} \frac{\partial(\rho H b \bar{u})}{\partial t} &= - \frac{\partial\left(\alpha' \rho H b \bar{u}^2 + \frac{1}{2} \rho g b H^2\right)}{\partial x} + \frac{\partial b \rho g H^2}{\partial x} - \rho g H b l_b \\ &= - \frac{\partial\left(\alpha' \rho H b \bar{u}^2\right)}{\partial x} - b \frac{\partial\left(\frac{1}{2} \rho g H^2\right)}{\partial x} - \rho g H b l_b \end{aligned} \quad (\text{A.1.3})$$

When the water level, h , is introduced into the relationship instead of water depth:

$$\frac{\partial h}{\partial x} = l_b + \frac{\partial H}{\partial x} \quad (\text{A.1.4})$$

and the equations are divided by ρ , the conservation laws of mass and momentum become:

$$\frac{\partial(Hb)}{\partial t} = - \frac{\partial(Hb\bar{u})}{\partial x} \quad (\text{A.1.5})$$

$$\frac{\partial(Hb\bar{u})}{\partial t} = - \frac{\partial(\alpha' H b \bar{u}^2)}{\partial x} - H b g \frac{\partial h}{\partial x} \quad (\text{A.1.6})$$

These equations can be integrated to describe the flow through cross sections of any shape when divided up into a series of rectangular cross sections as shown in Fig A.1.1:

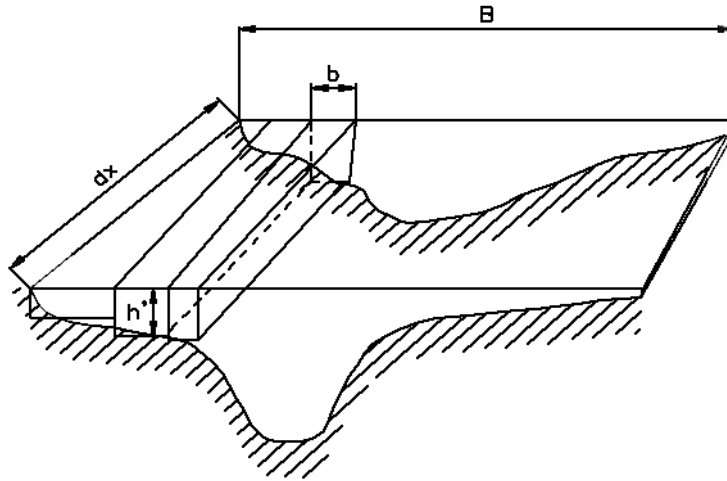

Fig A.1.1 Cross section divided into a series of rectangular channels

According to the previous assumptions, $\partial h / \partial x$ is constant across the channel and no exchange of momentum occurs between the sub-channels. If the integrated cross section area is called A and the integrated discharge q , and B is the full width of the channel, then:

$$A = \int_0^B H db \quad (\text{A.1.7})$$

$$q = \int_0^B H \bar{u} db = \bar{u} A \quad (\text{A.1.8})$$

Integrating the mass and momentum conservation equations and introducing Equations (A.1.7) and (A.1.8) yields:

$$\frac{\partial q}{\partial x} + \frac{\partial A}{\partial t} = 0 \quad (\text{A.1.9})$$

$$\frac{\partial q}{\partial t} + \frac{\partial \left(\alpha \frac{q^2}{A} \right)}{\partial x} + gA \frac{\partial h}{\partial x} = 0 \quad (\text{A.1.10})$$



Including the flow resistance term in the form as a friction slope, a lateral inflow q_{in} , and an external momentum forcing f into these equations leads to the basic equations used in the 1D engine:

$$\frac{\partial Q}{\partial x} + \frac{\partial A}{\partial t} = q_{in} \quad (\text{A.1.11})$$

$$\frac{\partial q}{\partial t} + \frac{\partial \left(\alpha \frac{q^2}{A} \right)}{\partial x} + gA \frac{\partial h}{\partial x} + gAl_f = f \quad (\text{A.1.12})$$

A.1.1 Pressurised Flow, Generalisation of Saint-Venant Equations

The idea of introducing a fictitious slot was first presented by Preissmann and Cunge, 1961 /2/, and has since been used by Cunge and Wegner, 1964 /1/.

To show that a top slot can be included without modifying the Saint-Venant equations, we start by rewriting the continuity equation as:

$$-\frac{\partial(\rho Q)}{\partial x} dx dt = \frac{\partial(\rho A)}{\partial t} dx dt \quad (\text{A.1.13})$$

assuming the density of water ρ is constant over the cross section.

By partial differentiation we find:

$$\frac{\partial Q}{\partial x} + \frac{Q}{\rho} \cdot \frac{\partial \rho}{\partial x} + \frac{\partial A}{\partial t} + \frac{A}{\rho} \cdot \frac{\partial \rho}{\partial t} = 0 \quad (\text{A.1.14})$$

For a circular closed reach, it can be shown that the density of the water can be approximated as:

$$\rho \approx \rho_0 \left(1 + \frac{g(y-D)}{a_0^2} \right) \quad (\text{A.1.15})$$

where:

- ρ_0 = the density of water for a free surface flow [kgm^{-3}]
- a_0 = the speed of sound in water [ms^{-1}]
- y = the water depth [m]
- D = the reach diameter [m].



Furthermore, it can be shown that the cross section area in the case of the excess pressure $\rho g(y-D)$ is approximately equal to:

$$A \approx A_0 \left(1 + \frac{g(y-D)}{a_r^2} \right) \quad (\text{A.1.16})$$

where

A_0 = the area without excess pressure and a_r is given as:

$$a_r = \sqrt{\frac{E_r \cdot e}{\rho_0 \cdot D}} \quad (\text{A.1.17})$$

and

E_r = the Young's modulus of elasticity, [Nm⁻²]
 e = the reach wall thickness, [m].

The a_r has the dimension ms⁻¹ and is in the order of 1400 ms⁻¹ for most concrete pipes.

Combining these equations yields:

$$\frac{\partial A}{\partial t} + \frac{A}{\rho} \cdot \frac{\partial \rho}{\partial t} = g \cdot A \frac{\partial y}{\partial t} \left(\frac{1}{a_r^2} + \frac{1}{a_0^2} \right) = \frac{gA_0}{a^2} \cdot \frac{\partial y}{\partial t} \quad (\text{A.1.18})$$

where:

$$a = \frac{a_0}{\sqrt{1 + a_0^2/a_r^2}} \quad (\text{A.1.19})$$

represents the speed of sound in water considering the compressibility of water and the deformation of the reach wall.

Equation (A.1.14) can now be written as:

$$\frac{\partial Q}{\partial x} + \frac{Q}{\rho} \cdot \frac{\partial \rho}{\partial x} + \frac{gA_0}{a^2} \cdot \frac{\partial y}{\partial t} = 0 \quad (\text{A.1.20})$$

If we further assume that the density of water varies only slowly along the reach so that

$$\frac{\partial \rho}{\partial x} = 0 \quad (\text{A.1.21})$$



and use that the cross section area for water level in the slot varies as:

$$\frac{\partial A}{\partial t} = b_{slot} \frac{\partial y}{\partial t} \quad (\text{A.1.22})$$

then the continuity equation can be recovered by choosing the slot width so that

$$b_{slot} = \frac{gA_0}{a^2} . \quad (\text{A.1.23})$$

a is in the order of 1000 [ms⁻¹] for most concrete pipes.



A.2 Solving the Saint-Venant Equations

This chapter describes how the Saint-Venant equations are solved. First, the equations are discretised on a grid in Section A.2.1, then the method of solving the resulting equations is presented in sections A.2.2. In the last two sections it is described how boundaries (Section A.2.3) and structures (Section A.2.4) are included.

A.2.1 Discretisation

Equations (A.1.11) and (A.1.12) are transformed to a set of implicit finite difference equations on a computational staggered grid consisting of alternating q - and h -grid points, i.e. points where the discharge, q and water level h , respectively, see Fig A.2.2.

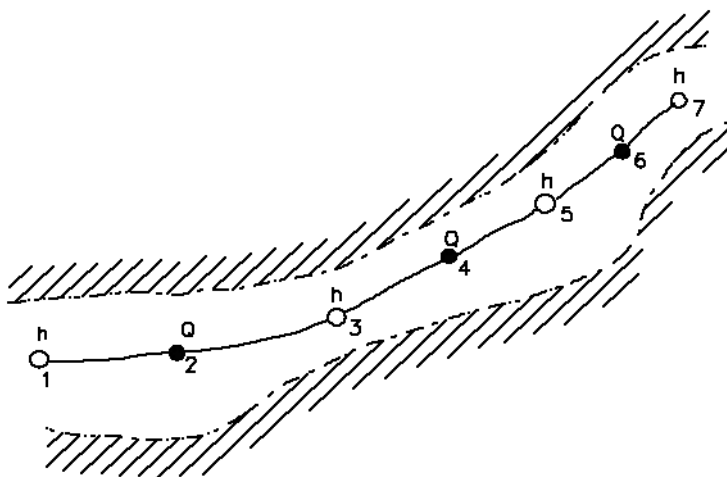

Fig A.2.2 Reach section with alternating q - and h -grid points

The computational grid is generated automatically on the basis of the user requirements. q -points are always placed midway between neighbouring h -points, while the distance between h -points may differ. The discharge is defined as positive in the positive x -direction (increasing chainage).

The minimum number of grid points in a reach is three: Two h -grid points and a q -grid point.

The adopted numerical scheme is the implicit 6-point scheme by Abbott and Ionescu (Abbott and Ionescu, 1967), as shown in Fig A.2.2. The basic idea is to use values adjacent in time and space to write down the derivative of q and h and thereby convert the two Saint-Venant equations to a set of coupled



implicit finite difference equations. Details are given below, first for the continuity equation and then for the momentum conservation equation.

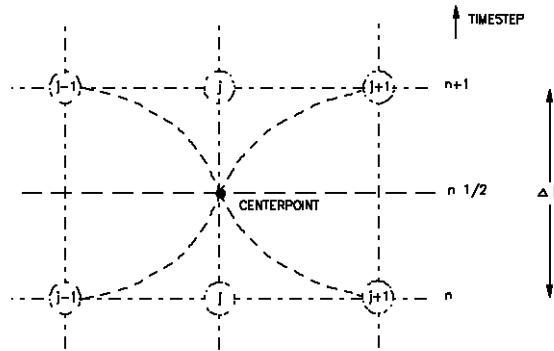

Fig A.2.3 Centred 6-point Abbot scheme

To obtain a time centred description, some terms must be available at time level $n+1/2$. That can only be fulfilled by iterating. For the first iteration, values at time $n+1/2$ are approximated at time n , and in subsequent iterations the values at time $n+1/2$ are weighted by values at time n and $n+1$:

$$A^{n+\delta} = \delta A^{n+1} + (1 - \delta)A^n \tag{A.2.1}$$

To get 2nd order accurate approximations $\delta = 1/2$ must be used.

The more iterations will provide the best possible time centred values,. The number of iterations can be controlled by the user.



MIKE+ does not iterate, and hence always uses the value at time n for the time centred terms. ■

A.2.1.1 Continuity equation

The continuity equation is approximated at all h -grid points.

In the continuity equation the storage width, b_s , is introduced as:

$$\frac{\partial A}{\partial t} = b_s \frac{\partial h}{\partial t} \tag{A.2.2}$$

giving:

$$\frac{\partial q}{\partial x} + b_s \frac{\partial h}{\partial t} = q_{ir} \tag{A.2.3}$$



As only q has a derivative with respect to x , the equation can easily be centred at an h -point, see Fig A.2.4.

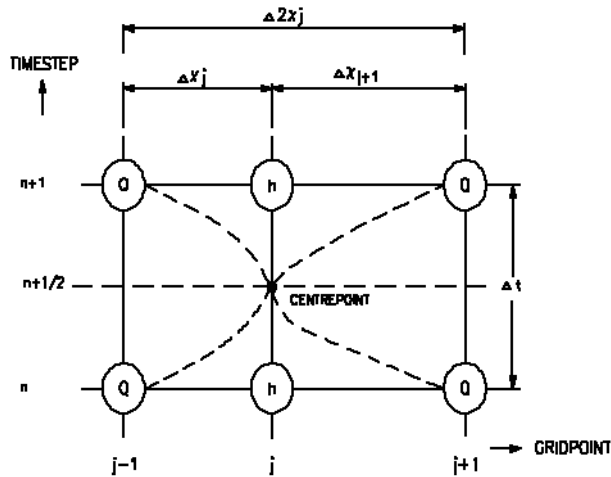

Fig A.2.4 Centring of continuity equation in 6-point Abbot scheme

The approximation of terms Equation (A.2.3) are expressed as follows:

$$\frac{\partial q}{\partial x} \approx \delta \frac{q_{j+1}^{n+1} - q_{j-1}^{n+1}}{\Delta 2x_j} + (1 - \delta) \frac{q_{j+1}^n - q_{j-1}^n}{\Delta 2x_j} \tag{A.2.4}$$

$$\frac{\partial h}{\partial t} \approx \frac{(h_j^{n+1} - h_j^n)}{\Delta t} \tag{A.2.5}$$

b_s in Equation (A.2.3) is retrieved from the cross section at the h grid point.



In MIKE+ type setups, b_s in Equation (A.2.3) is approximated differently, by:

$$b_s = \frac{A_{s,j-1/2} + A_{s,j+1/2}}{\Delta 2x_j} \tag{A.2.6}$$

where:

$A_{s,j-1/2}$ is the surface area between grid point $j-1$ and j

$A_{s,j+1/2}$ is the surface area between grid point j and $j+1$



The user can control if this approximation should be used. It will only be applied if the surrounding q-grid-point has a cross section (the MIKE+ fully dynamic scheme has this). ■

See Section A.3.1 for details on improvement on the mass balance.

Substituting for the derivatives in equation (A.2.3) gives a formulation of the following form for *h*-grid point *j*:

$$\alpha_j Q_{j-1}^{n+1} + \beta_j h_j^{n+1} + \gamma_j Q_{j+1}^{n+1} = \delta_j \tag{A.2.7}$$

where, α , β and γ are functions of b_s and δ and, moreover, depend on q and h at time level n and q on time level $n+1/2$.

The continuity equation for *h*-grid point *j* in the form (A.2.7) will be used to set up a system of equation in sections A.2.2.

A.2.1.2 Momentum equation

The momentum equation is centred at *q*-grid points as illustrated in Fig A.2.5.

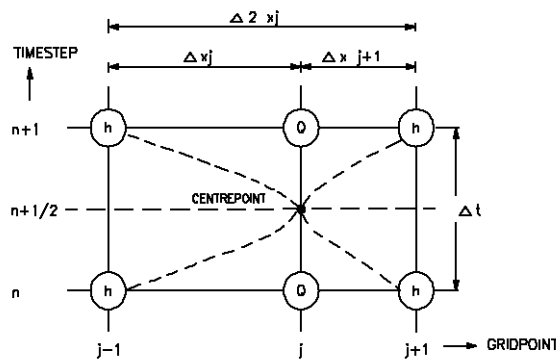

Fig A.2.5 Centring of momentum equation in the 6-point Abbot scheme

The approximation of each term in the Momentum Equation (A.1.12) differ for each of the schemes. The general approximations will be described first, followed by the special versions for each scheme.

The temporal term is approximated by:

$$\frac{\partial q}{\partial t} \approx \frac{q_j^{n+1} - q_j^n}{\Delta t} \tag{A.2.8}$$



The gravity term is approximated by

$$\frac{\partial h}{\partial x} \approx \delta \frac{h_{j+1}^{n+1} - h_{j-1}^{n+1}}{\Delta 2x_j} + (1 - \delta) \frac{h_{j+1}^n - h_{j-1}^n}{\Delta 2x_j} \quad (\text{A.2.9})$$

With all the terms having their approximation inserted, the momentum equation can be written in the following form:

$$\alpha_j h_{j-1}^{n+1} + \beta_j q_j^{n+1} + \gamma_j h_{j+1}^{n+1} = \delta_j \quad (\text{A.2.10})$$

The conservation of momentum equation for q -grid point j in the form (A.2.10) will be used to set up a system of equation.

Fully dynamic, higher order, MIKE 11

The momentum term is approximated at time $n+1/2$, when available, though in first iteration at time n .

$$\frac{\partial \left(\alpha \frac{q^2}{A_{fl}} \right)}{\partial x} \approx \frac{\left[\alpha \frac{q^2}{A_{fl}} \right]_{j+1}^{n+1/2} - \left[\alpha \frac{q^2}{A_{fl}} \right]_{j-1}^{n+1/2}}{\Delta 2x_j} \quad (\text{A.2.11})$$

The friction term is approximated using the higher order approximation of Verwer, described in Section A.2.1.3.

Diffusive wave, MIKE 11

In the diffusive wave approximation, all momentum terms are ignored and only the gravitation and friction terms are maintained. The Momentum Equation reduces to:

$$Q|Q| = -A^2 C^R R \frac{\partial h}{\partial x} = -K^2 \frac{\partial h}{\partial x} \quad (\text{A.2.12})$$

where K is conveyance. Using (A.2.9) and

$$Q|Q| \approx Q^{n+1} |Q^n| \quad (\text{A.2.13})$$

gives

$$\frac{K^2}{2\Delta 2x_j |Q^n|} (h_{j+1}^{n+1} - h_{j-1}^{n+1}) + Q^{n+1} + \frac{1}{2} Q^n = 0 \quad (\text{A.2.14})$$

which is of the form (A.2.10).



Kinematic wave, MIKE 11

In the kinematic wave approximation, the gravitational term is exactly cancelled by the friction term:

$$gA \frac{\partial h}{\partial x} + gAfQ|Q| = 0$$

From this simple equation Q is found as a function of h, and the discharge is computed from a Taylor expansion:

$$q_j^{n+1} = q_j^n + \frac{\Delta Q}{\Delta h} (h_{j+1}^{n+1} - h_{j+1}^n)$$

Fully dynamic, MIKE 11

The momentum term is included partly implicit. To ensure the correct sign for the term when the flow direction is changing during a time step, the semi implicit term is weighted with the explicit term:

$$q^2 \approx \theta q_j^{n+1} q_j^n - (\theta - 1) q_j^n q_j^n \quad (\text{A.2.15})$$

where θ can be specified by the user. The default value of θ is 1.0.

Fully dynamic, MIKE+

The momentum term is approximated based on the transformation introduced by Abbott and Ionescu (13/):

$$\frac{\partial \left(\frac{q^2}{A} \right)}{\partial x} = \frac{\partial (q \cdot qA^{-1})}{\partial x} = qA^{-1} \frac{\partial q}{\partial x} + Q \frac{\partial (qA^{-1})}{\partial x} \quad (\text{A.2.16})$$

Using the Continuity Equation(A.2.3) to eliminate the q derivative gives:

$$\frac{\partial \left(\frac{q^2}{A} \right)}{\partial x} = qA^{-1} \left(-b_s \frac{\partial h}{\partial t} + q_{in} \right) + Q \frac{\partial (qA^{-1})}{\partial x} \quad (\text{A.2.17})$$



The last term is approximated at time $n + \delta$, when available, though in first iteration at time n :

$$Q \frac{\partial(qA^{-1})}{\partial x} \approx ((1 - \delta)q^n + \delta q^{n+\delta}) \cdot \left(\frac{\left(\frac{q}{A}\right)_{j+1}^{n+\delta} - \left(\frac{q}{A}\right)_{j-1}^{n+\delta}}{\Delta x} \right) \quad (\text{A.2.18})$$

The resistance term in the fully dynamic MIKE+ scheme has several approximations, depending on the resistance formulation. If the resistance formulation is Manning M , in MIKE+ terms called *explicit Manning*, the term is included in the form:

$$I_f = \frac{\sqrt{I_r h}}{M A R^{2/3}} \quad (\text{A.2.19})$$

The user can also specify to use an *implicit Manning* formulation, in which case the friction term is approximated using the higher order approximation of Verwer, described in Section A.2.1.3.

The 1D engine currently only supports the explicit Manning formulation.



In MIKE+, the choice between explicit and implicit flow resistance description is made through the DHIAPP.INI file, see Appendix D.3. The explicit description is selected per default. ■

A.2.1.3 Implicit resistance implementation

The resistance term can be approximated using the higher order accurate approximation of Verwer, /42/. This higher order accurate approximation can greatly improve the stability of the scheme. It is based on a resistance formulation on the form

$$I_f = F = f q |q| \quad (\text{A.2.20})$$

where f is a generalised friction factor. The resistance term is approximated at time step $n + \delta$, i.e. time $t^n + \delta \cdot \Delta t$, using a Taylor expansion around time t^n , remembering that the friction factor $f = f(h)$ depends on the water level h :

$$F(t^n + \delta \Delta t) = F(t^n) + \delta \Delta t \frac{\partial F}{\partial t} = F(t^n) + \delta \Delta t \left(\frac{\partial F}{\partial q} \cdot \frac{\partial q}{\partial t} + \frac{\partial F}{\partial h} \cdot \frac{\partial h}{\partial t} \right) \quad (\text{A.2.21})$$



In terms of values at the time step n , it becomes

$$F^{n+\delta} \approx F^n + \delta \left(\frac{\partial F}{\partial q} \Big|_n \cdot \Delta q + \frac{\partial F}{\partial h} \Big|_n \cdot \Delta h \right) \quad (\text{A.2.22})$$

Expanding this gives

$$F^{n+\delta} \approx f^n |q^n| q^n + \delta \left(2f^n |q^n| \cdot (q^{n+\delta} - q^n) + |q^n| q^n \frac{\partial f}{\partial h} \Big|_n \cdot \Delta h \right) \quad (\text{A.2.23})$$

The friction factor derivative depends on the resistance formulation. For Manning M and Chezy, the factor is based on the conveyance,

$$K = K(h) = MAR^{2/3} \text{ or } CAR^{1/2} \quad (\text{A.2.24})$$

where

$$f = \frac{1}{K^2} = M^{-2}A^{-2}R^{(-4)/3} \text{ or } C^{-2}A^{-2}R^{-1} \quad (\text{A.2.25})$$

This gives the friction factor derivatives:

$$\frac{\partial f}{\partial h} = -2M^{-3} \frac{\partial M}{\partial h} A^{-2} R^{-4/3} - 2M^{-2} A^{-3} \frac{\partial A}{\partial h} R^{-4/3} - \frac{4}{3} M^{-2} A^{-2} R^{-1/3} \frac{\partial R}{\partial h} \quad (\text{A.2.26a})$$

$$\frac{\partial f}{\partial h} = -2C^{-3} \frac{\partial C}{\partial h} A^{-2} R^{-1} - 2C^{-2} A^{-3} \frac{\partial A}{\partial h} R^{-1} - C^{-2} A^{-2} R^{-2} \frac{\partial R}{\partial h} \quad (\text{A.2.26b})$$

which can be simplified to

$$\frac{\partial f}{\partial h} = f \left(-2M^{-1} \frac{\partial M}{\partial h} - 2A^{-1} \frac{\partial A}{\partial h} - \frac{4}{3} R^{-1} \frac{\partial R}{\partial h} \right) \quad (\text{A.2.27a})$$

$$\frac{\partial f}{\partial h} = f \left(-2C^{-1} \frac{\partial C}{\partial h} - 2A^{-1} \frac{\partial A}{\partial h} - R^{-1} \frac{\partial R}{\partial h} \right) \quad (\text{A.2.27b})$$

The Δh term is approximated at the h grid point in the flow upstream direction, i.e.

$$\Delta h = h_{us}^{n+1} - h_{us}^{n-1} \quad (\text{A.2.28})$$



where

$$h_{us} = \begin{cases} h_{j-1} & \text{if } (q_j > 0) \\ h_{j+1} & \text{if } (q_j < 0) \end{cases}, h_{ds} = \begin{cases} h_{j+1} & \text{if } (q_j > 0) \\ h_{j-1} & \text{if } (q_j < 0) \end{cases} \quad (\text{A.2.29})$$

The coefficient δ determines the time weighting of the scheme. For stability reasons the coefficient should be above 0.5.

A.2.2 Node Equations

In nodes a continuity equation covering the surrounding h - and q -grid points is set up. Fig A.2.6 gives a close look at the grid points surrounding a node.

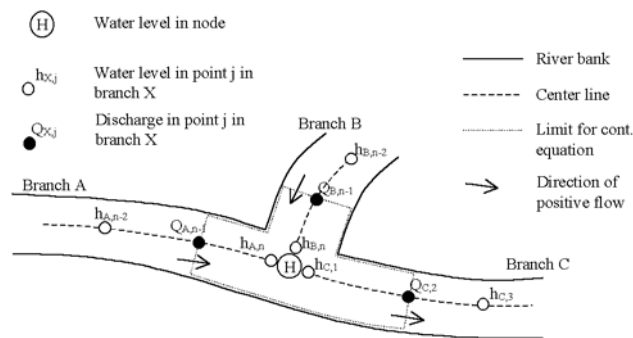

Fig A.2.6 Node with three reaches connected to it

The finite difference approximation of the continuity equation around the node is given by:

$$\begin{aligned} \frac{H^{n+1} - H^n}{\Delta t} A_{fl} &= q_I^{n+1/2} - q_O^{n+1/2} \\ \Rightarrow \frac{H^{n+1} - H^n}{\Delta t} A_{fl} &= \frac{1}{2}(q_{A,n-1}^n + q_{B,n-1}^n - q_{C,2}^n) \\ &\quad + \frac{1}{2}(q_{A,n-1}^{n+1} + q_{B,n-1}^{n+1} - q_{C,2}^{n+1}) \end{aligned} \quad (\text{A.2.30})$$

where

- q_I Sum of inflows
- q_O Sum of outflows
- Δt Time step

A.2.3 Including Boundaries in the Equations

The following three types of boundary conditions can be applied:

- Water level as a function of time
- Discharge as a function of time
- A tabulated relation between water level and discharge (Q/h boundary)

Each of the boundary types is taken into account by using a different node equation.

A.2.3.1 Water level as a function of time.

In this case the water level in the node at time step $n+1$ simply becomes the value of the user-specified boundary at time step $n+1$ ($H_{boundary}^{n+1}$) i.e. in the relevant equation (or row) in the node matrix only the diagonal and the right hand side coefficient are different from zero, and equals respectively 1 and $H_{boundary}^{n+1}$.

A.2.3.2 Discharge as function of time.

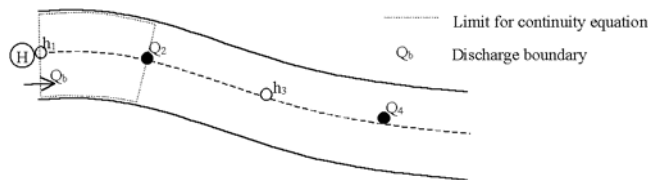

Fig A.2.7 Reach with discharge boundary

In this case a local continuity equation covering the area indicated in Fig A.2.7 is set up. Equation (A.2.30) becomes:

$$\frac{H^{n+1} - H^n}{\Delta t} A_{fl} = \frac{1}{2}(q_b^n - q_2^n) + \frac{1}{2}(q_b^{n+1} - q_2^{n+1}) \quad (\text{A.2.31})$$

A.2.3.3 QH Boundary

In this case the user specifies a tabulated relation between h and Q . A continuity equation is set up at the boundary in the same way as for a discharge boundary. The discharge at the boundary q_b is expressed as a function of the water level in the node using the tabulated relation. This is done as follows:



The index i is found such that $H_{\text{tab},i} \leq H^n < H_{\text{tab},i+1}$, and the ratio a is calculated according to equation (A.2.32).

$$a = \frac{q_{\text{tab},i+1} - q_{\text{tab},i}}{H_{\text{tab},i+1} - H_{\text{tab},i}} \quad (\text{A.2.32})$$

Using linear interpolation between the tabulated values of water levels and discharge equations (A.2.33) and (A.2.34) can be achieved:

$$q_b^{n+1} = q_{\text{tab},i} + a(H^{n+1} - H_{\text{tab},i}) \quad (\text{A.2.33})$$

$$q_b^n = q_{\text{tab},i} + a(H^n - H_{\text{tab},i}) \quad (\text{A.2.34})$$

Equations (A.2.33) and (A.2.34) are substituted into equation (A.2.31) and equation (A.2.35) is achieved:

$$\begin{aligned} \frac{H^{n+1} - H^n}{\Delta t} A_{fl} = & \frac{1}{2}(q_{\text{tab},i} + a(H^n - H_{\text{tab},i}) - q_2^n) \\ & + \frac{1}{2}(q_{\text{tab},i} + a(H^{n+1} - H_{\text{tab},i}) - q_2^{n+1}) \end{aligned} \quad (\text{A.2.35})$$

A.2.4 Structures

In general, the structure description in MIKE 1D combines a wide range of elements including weirs, narrow cross sections, flood plains, etc. The concept is based on the calculation of a discharge through the structure as a function of the upstream and downstream water levels, which is then applied on a q-grid point.

MIKE 1D can include structure calculations using two different modes: discharge mode and head loss mode. Not all structures can use both modes. Discharge mode is applicable for all structures. Head loss mode is applicable for Energy equation structures only. Head loss mode is the most recent addition, introduced by Release 2022. Discharge mode corresponds to using the Eqs. (A.2.38) and (A.2.39) described in Appendix A.2.4.1. Head loss mode corresponds to using Eq. (A.2.44) described in Appendix A.2.4.2.

Energy equation structures supporting head loss mode are:

- Bridges
- Culverts
- Energy loss structures
- Gates
- Broad crested weirs (not Overflow weirs)



For all other structures, the discharge mode is always applied.

The head loss mode is only applicable under sub-critical conditions. If the structure flow is evaluated as super critical, calculations revert to discharge mode.

A.2.4.1 Discharge mode

The discharge mode is based on the structures explicitly calculating a discharge through the structure q_s , typically based on the surrounding water levels.

$$q_s = f(h_{us}, h_{ds}) \quad (\text{A.2.36})$$

Here h_{us} is the upstream water level and h_{ds} is the downstream water level. This discharge replaces the evaluation of the momentum equation on a q-grid point. In the simplest form, the structure discharge directly enters Equation (A.2.10) in the form:

$$q^{n+1} = \tilde{q}_s^n \quad (\text{A.2.37})$$

The superscript for the structure discharge, \tilde{n} , indicates that the structure flow is evaluated at time n . However, when more than one iteration per time step is applied, this can optionally be changed to evaluate using the intermediate iteration solution at time $\widetilde{n + \frac{1}{2}}$ or $\widetilde{n + 1}$.

To increase accuracy and stability, the structure can also calculate derivatives with respect to upstream and downstream water levels, and then the discharge is evaluated for time $n+1$ as follows:

$$q^{n+1} = q_s^n + \frac{dq_s^n}{dh_{us}}(h_{us}^{n+1} - h_{us}^n) + \frac{dq_s^n}{dh_{ds}}(h_{ds}^{n+1} - h_{ds}^n) \quad (\text{A.2.38})$$

or on the form of Eq. (A.2.10):

$$-\frac{dq_s^n}{dh_{us}}h_{us}^{n+1} + q^{n+1} - \frac{dq_s^n}{dh_{ds}}h_{ds}^{n+1} = q_s^n - \frac{dq_s^n}{dh_{us}}h_{us}^n - \frac{dq_s^n}{dh_{ds}}h_{ds}^n \quad (\text{A.2.39})$$



Which gives:

$$\alpha_j = -\frac{dq_s^n}{dh_{us}} \quad (\text{A.2.40})$$

$$\beta_j = 1 \quad (\text{A.2.41})$$

$$\gamma_j = -\frac{dq_s^n}{dh_{ds}} \quad (\text{A.2.42})$$

$$\delta_j = q_s^n - \frac{dq_s^n}{dh_{us}} h_{us}^n - \frac{dq_s^n}{dh_{ds}} h_{ds}^n \quad (\text{A.2.43})$$

A.2.4.2 Head loss mode

In head loss mode, the effect of structures is applied by including an additional head loss term (HL) inside Saint-Venant momentum equation:

$$\frac{\partial q}{\partial t} + \frac{\partial \left(\alpha \frac{q^2}{A} \right)}{\partial x} + gA \frac{\partial h}{\partial x} - ga \frac{HL}{\Delta x} + gA I_f = f \quad (\text{A.2.44})$$

with Δx being the distance between to computational h-points surrounding the structure. The advantage of this approach is that it allows for structures with zero head loss, simply by evaluating the HL term to zero. Furthermore, it includes bed friction f between two h-points in the normal way. This approach is especially relevant for structures that do not interact with the flow until at some water level, (e.g. a bridge overflow). Note that the zero head loss scenario the discharge mode cannot handle.

When the flow through the structure becomes critical $Q \geq Q_{critical}$, the calculations are switched to the discharge mode.

This head loss term is evaluated in the following way:

1. The typical energy equations are solved to determine the structure flow q_s (for example, see Eq. (6.18)). The energy equation usually relates the water level difference and the structure discharge in the following way:

$$h_{in,s} - h_{out,s} = c(h_{in,s}, h_{out,s}, q_s) q_s^2 \quad (\text{A.2.45})$$

Here we introduce the concept of an overall head loss coefficient $c(h_{in,s}, h_{out,s}, q_s)$. This coefficient is a function of inflow and outflow water levels



at the structure $h_{in,s}$, $h_{out,s}$ and the structure discharge q_s . For small water level differences $h_{in,s} - h_{out,s}$, we have $c(h_{in,s}, h_{out,s}, q_s) \approx c(h_{in,s}, h_{out,s})$.

2. The actual discharge in the structure from previous Saint-Venant equation solution is $q_{SV}=q^n$. It is used to evaluate a head loss $HL=h'_{in,s} - h'_{out,s}$ by assuming that the head loss coefficient ($h_{in,s}$, $h_{out,s}$, q_s) is the same as from the calculation in point 1.

$$HL = h'_{in,s} - h'_{out,s} = c(h_{in,s}, h_{out,s}, q_s) q_{SV}^2 = (h_{in,s} - h_{out,s}) \frac{q_{SV}^2}{q_s^2} \quad (\text{A.2.46})$$

We stress that the Saint-Venant discharges q^n or q^{n+1} are not the same as the structure discharge $q_s=q_s(h_{us}^n, h_{ds}^n)$ coming as a solution to the energy equation. However, if a stationary flow state is reached q_{SV} and q_s do become the same.

3. Note that here the inflow/outflow water levels at the structure $h_{in,s}$, $h_{out,s}$ are not upstream/downstream water levels h_{us} , h_{ds} of the corresponding H-grid points. The inflow/outflow water levels at the structure are upstream/downstream water levels modified by the friction loss of the flow. This is needed to not double count the effect of the friction loss also appearing in Eq. (A.2.44). The h_{us} and h_{ds} can be modified in a simplified way as

$$\begin{aligned} h_{in,s} &= h_{us}^n - \min \left[\frac{q_{SV}^2}{K_{us}^2}, k \right] l_{us} \\ h_{out,s} &= h_{ds}^n - \min \left[\frac{q_{SV}^2}{K_{ds}^2}, k \right] l_{ds} \\ k &= \frac{h_{us} - h_{ds}}{l_{us} + l_{ds}} \end{aligned} \quad (\text{A.2.47})$$

Here:

$l_{us/ds}$ distance from upstream/downstream location to the structure, (m)

$K_{us/ds}$ conveyance at the upstream/downstream cross section, (m³/s)

One of the main assumptions for Eq. (A.2.47) to be valid is that the head loss appearing due to flow from upstream cross section to structure and from structure to downstream cross section is considerably smaller than the head loss happening in the structure.



Time discretization of head loss term

The head loss term is dependent on discharge q_{SV} and inflow/outflow water levels $h_{us/ds}$. At discrete time step $n+1$ it can be Taylor expanded as

$$HL^{n+1} \approx HL^n + \frac{dHL^n}{dq_{SV}}(q^{n+1} - q^n) + (h_{ds}^{n+1} - h_{ds}^n) + \frac{dHL^n}{dh_{us}}(h_{us}^{n+1} - h_{us}^n) + \frac{dHL^n}{dh_{ds}}(h_{ds}^{n+1} - h_{ds}^n) \quad (A.2.48)$$

The head loss derivative with respect to discharge is interpreted as derivative with respect to q_{SV} and using Eq. (A.2.46) it becomes:

$$\frac{dHL^n}{dq_{SV}} \approx \frac{dHL^n}{dq_{SV}} = 2(h_{in,s} - h_{out,s}) \frac{q_{SV}}{q_s^2} \quad (A.2.49)$$

In the current Mike1D implementation of head loss mode the $dHL/dh_{us/ds}$ terms are disregarded and only the dHL/dq_{SV} term is kept in Eq. (A.2.48).

A.2.4.3 Linearisation of flow when head approaches zero

When the head across the structure approaches zero, a linearisation is used in order to avoid discontinuities. If the difference between up- and down-stream water levels is below the $delH$, then the discharge and discharge derivatives are linearly interpolated between zero and their value at a water level difference of $delH$.

A.2.4.4 General energy headloss considerations

The description generally used for flow through a structure is given by:

$$\Delta H = \zeta \frac{V_s^2}{2g} \quad (A.2.50)$$

where ΔH is the energy headloss over the structure, ζ is a headloss coefficient and V_s is the mean cross sectional velocity at the structure.

For broad crested weir, special weir and culverts the headloss is divided into inflow (contraction) and outflow (expansion) components.



In the case of a sudden expansion the energy loss can be described as (A.2.50) and as:

$$\Delta H = f \frac{(V_s - V_2)^2}{2g} \quad (\text{A.2.51})$$

Setting (A.2.50) equal to (A.2.51) gives:

$$\zeta_2 \frac{V_s^2}{2g} = f \frac{(V_s - V_2)^2}{2g} \quad (\text{A.2.52})$$

which can be reduced to:

$$\zeta_2 = f \left(1 - \frac{V_2}{V_s}\right)^2 \quad (\text{A.2.53})$$

f , is equal to the user defined outflow headloss coefficient (ζ_{out}) and (A.2.53) becomes equal to:

$$\zeta_2 = \zeta_{out} \left(1 - \frac{V_2}{V_s}\right)^2 \quad (\text{A.2.54})$$

Equation (A.2.54) can also be written in the form:

$$\zeta_2 = \zeta_{out} \left(1 - \frac{Q_2 A_s}{A_2 Q_s}\right)^2 \quad (\text{A.2.55})$$

Which in case of a single structure ($Q_s = Q_2$, see Fig A.2.8) is equal to:

$$\zeta_2 = \zeta_{out} \left(1 - \frac{A_s}{A_2}\right)^2 \quad (\text{A.2.56})$$

For a parallel structure (A.2.55) cannot be reduced to (A.2.56) as ($Q_s \neq Q_2$) consequently equation (A.2.54) can be applied instead.

A similar approach can be used for adjustment of inflow headloss:

$$\zeta_1 = \zeta_{in} \left(1 - \frac{V_1}{V_s}\right) \quad (\text{A.2.57})$$

where, ζ_1 and ζ_2 are the adjusted inflow and outflow headloss coefficients calculated using the inflow and outflow loss coefficients (ζ_{in} and ζ_{out}).

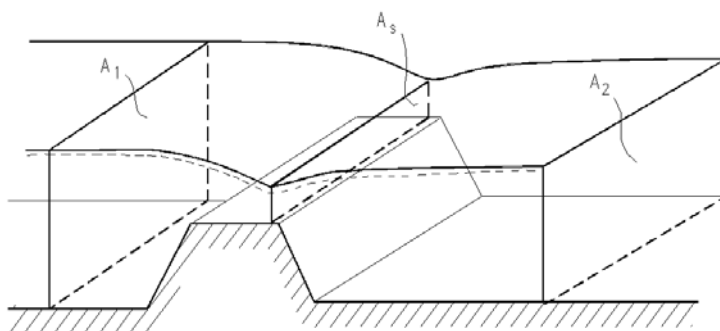

Fig A.2.8 Cross sectional flow areas at a structure



A minimum value for ζ_1 and ζ_2 can be specified in the HD parameter editor under the Default Values tab as ZetaMin. In the case $A_s \rightarrow A_1$ the solution can become unstable (no friction) and specification of a minimum value of $\zeta_{1,2}$, ensures a stable solution. ■

A.2.4.5 Expansion and contraction coefficients

As described in the previous section, flow through a structure is described according to:

$$\Delta h = \zeta_t \frac{Q^2}{2gA^2} \quad (\text{A.2.58})$$

This equation ζ_t describes the total headloss coefficient, which is composed of entrance (ζ_1) and exit (ζ_2) coefficients. For subcritical flow the coefficients are related to the input parameters ζ_{in} and ζ_{out} and the changes in velocity (v) and area (A):

$$\zeta_t = \zeta_1 + \zeta_2 = \zeta_{in} \left(1 - \frac{v_1}{v_s}\right) + \zeta_{out} \left(1 - \frac{A_s}{A_2}\right)^2 \quad (\text{A.2.59})$$

For subcritical flow through a structure there is an upstream contraction and a downstream expansion, so equation (A.2.59) works fine. When there is supercritical flow there is an upstream expansion and a downstream contraction. Thus if supercritical flow occurs then the loss coefficients are no longer



valid. To accommodate supercritical flow, calculation of the of entrance (ζ_1) and exit (ζ_2) coefficients are expanded:

$$\zeta_1 = \begin{cases} \zeta_{in} \left(1 - \frac{v_1}{v_s}\right) & \text{for } v_1 < v_s \\ \zeta_{in} \left(1 - \frac{A_1}{A_s}\right)^2 & \text{for } v_1 > v_s \end{cases} \quad (\text{A.2.60})$$

$$\zeta_2 = \begin{cases} \zeta_{out} \left(1 - \frac{v_s}{v_2}\right) & \text{for } v_s < v_2 \\ \zeta_{out} \left(1 - \frac{A_s}{A_2}\right)^2 & \text{for } v_s > v_2 \end{cases} \quad (\text{A.2.61})$$

Care must be taken when selecting loss coefficients, particularly in situations where both subcritical and supercritical flow conditions occur. When flow conditions change from subcritical to supercritical (or the Froude number F_R becomes greater than 1), the loss coefficients ζ_{in} and ζ_{out} (specified in the Headloss Factors box) are modified:

- If $F_R > 1$ in upstream h-point then $\zeta_{in} = \zeta_{in} / 2$
- If $F_R > 1$ in downstream h-point then $\zeta_{out} = \zeta_{out} / 2$

Note that this adjustment is not made for bridge structures.

A.2.4.6 Determination of flow regime

Given the upstream and downstream water levels and the discharge, and assuming that these three values are compatible with each other, the type of flow can be determined as follows.

For zero flow the upstream and downstream water levels are both below the structure invert (crest level) and the flow regime is subcritical, or the flow direction is opposite valve regulation.

For differentiating between critical and drowned flow it is assumed, in the first instance, that the flow at the weir crest is critical.

The critical discharge is determined for broad crested weirs, special weirs and culverts via the tabulated QH -relation while it in case of structures with time dependent geometry is computed by critical flow iteration during the simulation. The pre-processed QH -relation for broad crested weirs are based on the assumption of a single structure, hence when the broad crested weir is a part of a composite structure the QH -relation is no longer valid. In this case the critical discharge is computed by iteration during the simulation. When



special weirs and culverts are included in a composite structure it is assumed that the user defined QH -relations for critical flow takes the changed hydraulic conditions into account. When the upstream flow regime is supercritical, the QH -relations are also recalculated.

When a long culvert is a part of a composite structure, there is no critical discharge iteration i.e. the computed QH -relation is used to estimate the critical discharge. This approach is assumed valid as the structure area usually is much smaller than the upstream area i.e. $A_s \ll A_1$ hence no need for iteration.

Critical flow occurs (for $\zeta_2 > 1$) when the energy head at the crest is larger than the downstream energy head, viz.:

$$h_s + (1 - \zeta_2) \frac{Q_s^2}{2gA_s^2} \geq h_2 + \frac{Q_s^2}{2gA_2^2} \quad (\text{A.2.62})$$

Critical flow occurs (for $\zeta_2 \leq 1$ and outflow headloss less or equal to 1) when the water level at the crest is larger than the downstream energy head:

$$h_s \geq h_2 + \frac{Q_s^2}{2gA_2^2} \quad (\text{A.2.63})$$

If the flow is not critical, a submerged discharge iteration is performed and the submerged discharge is compared with the critical and the smallest is taken.

A.2.4.7 Discharge over specific structures

How the discharge and the discharge derivatives over specific structures for use in equation (A.2.39) are calculated is not presented in this document for all structures.

Section B.1 QH Relations Calculated for Culverts (p. 315) presents some details for culverts.

A.2.5 DELTA Coefficient

A forward centring of the $\partial h / \partial x$ term in the numerical scheme has a dissipative influence which can be demonstrated using the Taylor-series. The forward centring is automatically introduced in MIKE 1D when the flow becomes supercritical in a particular section of a reach. Additionally, the centring can be specified by the user for subcritical flows through the centring coefficient DELTA ($0.5 < \delta < 1$).



Introducing the δ value into the terms gives:

$$\frac{\partial h}{\partial x} = \delta \frac{h_{j+1}^{n+1} - h_{j-1}^{n+1}}{\Delta 2x} + (1 - \delta) \frac{h_{j+1}^n - h_{j-1}^n}{\Delta 2x} \quad (\text{A.2.64})$$

Using a Taylor series up to the third derivative, these terms become:

$$\begin{aligned} \frac{h_{j+1}^{n+1} - h_{j-1}^{n+1}}{\Delta 2x} &= \frac{\delta}{\Delta 2x} \left[h + \frac{1}{1!} \frac{\Delta 2x}{2} \frac{\partial h}{\partial x} + \frac{1}{2!} \left(\frac{\Delta 2x}{2} \right)^2 \frac{\partial^2 h}{\partial x^2} \right. \\ &\quad \left. + \frac{1}{3!} \left(\frac{\Delta 2x}{2} \right)^3 \frac{\partial^3 h}{\partial x^3} - h + \frac{1}{1!} \frac{\Delta 2x}{2} \frac{\partial h}{\partial x} + \frac{1}{2!} \left(\frac{\Delta 2x}{2} \right)^2 \frac{\partial^2 h}{\partial x^2} \right. \\ &\quad \left. + \frac{1}{3!} \left(\frac{\Delta 2x}{2} \right)^3 \frac{\partial^3 h}{\partial x^3} \right]_j^{n+1} = \delta \left[\frac{\partial h}{\partial x} + \frac{(\Delta 2x)^2}{24} \frac{\partial^3 h}{\partial x^3} \right]_j \end{aligned} \quad (\text{A.2.65})$$

Similarly for the last term:

$$(1 - \delta) \frac{h_{j+1}^n - h_{j-1}^n}{\Delta 2x} = (1 - \delta) \left[\frac{\partial h}{\partial x} + \frac{(\Delta 2x)^2}{24} \frac{\partial^3 h}{\partial x^3} \right]_j^n \quad (\text{A.2.66})$$

In this way the formulation of $\partial h / \partial x$ in (A.2.64) becomes (again using a Taylor series):

$$\begin{aligned} \frac{\partial h}{\partial x} &= \delta \left[\frac{\partial h}{\partial x} + \frac{1}{1!} \frac{\Delta t}{2} \frac{\partial^2 h}{\partial x \partial t} + \frac{1}{2!} \left(\frac{\Delta t}{2} \right)^2 \frac{\partial^3 h}{\partial x \partial t^2} \right]_j^{n+1/2} \\ &\quad + (1 - \delta) \left[\frac{\partial h}{\partial x} - \frac{1}{1!} \frac{\Delta t}{2} \frac{\partial^2 h}{\partial x \partial t} + \frac{1}{2!} \left(\frac{\Delta t}{2} \right)^2 \frac{\partial^3 h}{\partial x \partial t^2} \right]_j^{n+1/2} \\ &= \frac{\partial h}{\partial x} \Big|^{n+1/2} + (2\delta - 1) \frac{\Delta t}{2} \frac{\partial^2 h}{\partial x \partial t} \Big|^{n+1/2} + \text{higher order terms} \end{aligned} \quad (\text{A.2.67})$$

which represents a dissipative effect, when $\delta > 0.5$, as the last term before the higher order terms becomes positive.

Also note that for $\delta > 0.5$, the solution scheme is not second order, since $2\delta - 1$ not zero in equation (A.2.67).



A.3 Mass Balance

Theoretically, the applied computational scheme should ensure mass conservation in every case. In practical applications, the mass balance may be jeopardised in a number of situations, such as:

- Relatively sharp changes of storage width due to rapid changes of water depth or a sharp change of cross section shape with depth. This may be e.g. the case at relatively small depths in circular pipes and in cross sections with flow bank zones.
- Sharp changes in surface area of basins
- Surcharge of manholes

The scale of the problem is usually related to the length of the simulation time step.

A.3.1 Improved Continuity Balance for Links



This section applies to MIKE+ type setups only.

While solving the continuity equation:

$$\frac{\partial q}{\partial x} + b_s \frac{\partial h}{\partial t} = q_{in} \quad (\text{A.3.1})$$

the storage width, b_s , is in the first iteration approximated at time n , and in subsequent iterations at time $n+1/2$. In situations where only one iteration is performed, as is typically the case in MIKE+ type setups, the approximation can imply a significant amount of water being generated or disappearing, giving a significant mass balance error.

A Taylor expansion of the storage width can greatly improve on the mass balance error. Expanding the storage width around time n gives:

$$b_s^{n+\delta} = b_s^n + \delta \Delta t \frac{\partial b}{\partial h} \frac{\partial h}{\partial t} \quad (\text{A.3.2})$$

Isolating and inserting the $\partial h / \partial t$ term from the continuity equation:

$$b_s^{n+\delta} = b_s^n + \delta \frac{\Delta t \partial b}{b_s \partial h} \left(-\frac{\partial q}{\partial x} + q_{in} \right) \quad (\text{A.3.3})$$



Rearrange to get the contribution as a correction term:

$$b_s^{n+\delta} = b_s^n \cdot \left(1 + \delta \frac{\Delta t}{(b_s^n)^2} \frac{\partial b}{\partial h} \left| \left(-\frac{\partial q}{\partial x} \right|^n + q_{in} \right) \right. \right) \quad (\text{A.3.4})$$

This modification is applicable only for cross sections with relatively smooth changes of the storage width. As the width for arbitrary cross sections can vary in very unpredictable ways, the correction is only applied to the standard predefined cross sections.

It should be noted that errors in the mass balance occur when changes in storage width are significant as the water level changes. Since cross sections typically become narrow at the bottom, errors in the mass balance can sometimes be controlled by adjusting the minimum water depth (i.e. make sure that reaches do not run dry). See the user manual for information about how to control the minimum water depth.



A.4 Some Special Techniques

A.4.1 Expanding Nodes (Surface Flooding)

If the water level in an open manhole or a basin reaches ground level, an artificial inundation basin is inserted above the node. The surface area of this basin is gradually increased from the area in the manhole or the basin to a 1000 times larger area, thus simulating the surface inundation. When the outflow from the node surmounts the inflow, the water stored in the inundation basin re-enters the system.

The inundation is simulated by applying an expanding cover above ground level that expands to 1000 times the diameter of the node. The expansion happens gradually over a height of one metre, starting 0.25m (default value) below ground level.

Mathematically, the expanding cover enters the node equations (see Section A.2.2) only through the calculation of the surface area in the node. For the expanding cover, the surface area is

$$A_{fl} = \text{Min}(A_{fl,node} \cdot e^{7(H-H_{gl}-0.25)}, 1000A_{fl,node}) \quad (\text{A.4.1})$$

where $A_{fl,node}$ is the surface area just below the cover and H_{gl} is the ground level.

When the water level in the node increases and is above ground level, it is assumed that during a time step, the surface area in the basin is calculated using the water level from the start of the actual time step. A situation like this is shown in Fig A.4.9. If the water level passes through the transition region between the actual manhole or structure and the artificial basin. This leads to generation of water. In Fig A.4.9 the shaded area illustrates the generated volume of water.

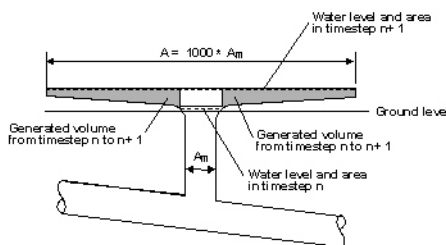

Fig A.4.9 Simulation of surface flooding



When the increase of the water level during a time step is relatively small, then the generated water volume is negligible. If the water level is changing rapidly, the generated volume of water is important. Therefore, MIKE 1D will calculate the difference in water volume and correct the mass balance accordingly in the following time step.

A.4.2 Sealed Nodes

Manholes and basins can be defined as 'sealed'. If they are defined as sealed, then water will not flow onto the surface. Instead, the water enters a narrow slot comparable to the slot on closed cross sections.

The narrow slot is simulated with a sealed cover that gradually contracts to a slot with a diameter of w_{slot}^2 times the node diameter, where w_{slot} is the width of a slot cover at infinite height. The contraction happens gradually, starting 0.25m (default value) below ground level.

Mathematically, the sealed cover enters the node equations (see Section A.2.2) only through the calculation of the surface area in the node. For a sealed cover the surface area is

$$A_{fl} = A_{fl, node} \left((1 - w_{slot}) e^{0.6 \frac{(H - H_{gl} - 0.25)}{D}} - w_{slot} \right) \quad (A.4.2)$$

where D is the diameter of the node just below the cover.

A.4.3 Spilling Nodes

Any manhole or basin can be defined as 'spilling'. If the water level in a node defined as a spilling node reaches the ground level, the water will start spilling irreversibly out of the system. The flow will be computed using the free over-flow formula, according to the following:

$$\text{for } H \leq (H_{gl} + \Delta P): \quad (11.1)$$

$$Q_{spill} = 0;$$

$$\text{for } H > (H_{gl} + \Delta P):$$

$$Q_{spill} = \text{Relative Weir Coefficient} \cdot 0.63 \cdot B \cdot \sqrt{2g} \cdot (H - (H_{gl} + \Delta P))^{3/2}$$

where:

$$Q_{spill} = \text{the spill discharge [m}^3\text{/s],}$$

$$B = \text{a conceptual spill width [m],}$$

$$H = \text{the water level in the manhole [m],}$$



H_{gl} = the ground level in the manhole [m],
 ΔP = the "Buffer Pressure Level" for the spill [m],
 g = the acceleration of gravity [ms^{-2}],
RelativeWeirCoefficient = the linear scaling coefficient for the spill.

The level (i.e. head) at which the spill starts can be controlled by optionally specifying the 'Buffer Pressure Level' as a relative elevation above (or below) the ground surface (default value = 0).

For circular manholes, the spill width B equals to 1.5 times the manhole diameter for the water level $H = H_{gl} + \Delta P$. With increasing water level, the spill width B increases, following the same functional relation as used for the area above expanding nodes (i.e. increases exponentially to approximately Max. 1000 times the manhole diameter), see Section A.4.1.

The spilling capacity of a spilling manhole can be controlled by specifying the Relative Weir Coefficient (default value = 1).

A.4.4 Dry Conduits and Numerical Water



This section applies to MIKE+ type setups, where a bottom slot is not applied.

The 1D engine will not allow the water depth in reaches to become zero. If parts of the network are close to drying out, then the 1D engine maintains a minimum water depth in those parts, that by default is 5‰ of the characteristic dimension of the conduit (diameter for circular pipes), or Max. 5 mm. This is necessary in order to maintain numerical stability in the solution of the flow equations.

This correction practically means artificial generation of water, i.e. some water volume is added to the system. As a consequence of that, the continuity status report shown does not give a fair impression of the accuracy of the simulation. The amount of water added due to drying out of reaches is normally referred to as *numerical water*.

A.4.5 Bottom Slots

During low flow conditions (the local water depth is less than DELH, where DELH is a user specified parameter) a bottom slot can be introduced into the computations. The slot starts DELH over the bottom and extends 5 times DELH below the cross section bottom, see Fig A.4.10.

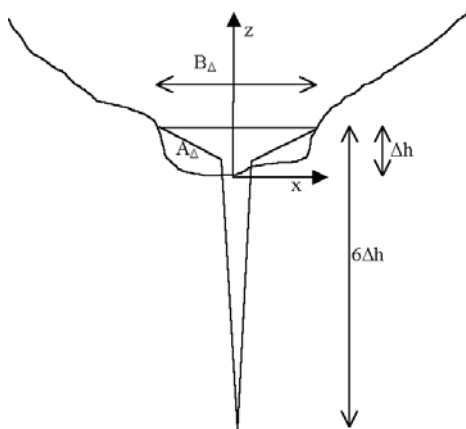

Fig A.4.10 The geometry of bottom slots

There are two different alternatives for the description of the slot.

A.4.5.1 Classical bottom slot

The classical bottom slot description is given by

$$B = \frac{\sqrt{z + 5\Delta h}}{\sqrt{6\Delta h}} B_{\Delta} \quad (\text{A.4.3})$$

where z is the water depth with origin at the bed (lowest cross section point), i.e. it can be negative. It has the area

$$A(z) = \int_{-5\Delta h}^z B dz = \frac{2(z + 5\Delta h)^{3/2}}{3\sqrt{6\Delta h}} B_{\Delta} \quad (\text{A.4.4})$$

A.4.5.2 Area preserving bottom slot

As an alternative the slot may given a geometry such that the cross sectional area at the top of the slot matches exactly that of the cross section at that level, i.e. the area varies continuously across the level at which the slot is introduced.



The width B of the slot is given by the following expression



$$B = \begin{cases} \frac{B_{\Delta}(\Delta h - z_0)}{\Delta h(z_0 + 5\Delta h)}(z + 5\Delta h) & \text{for } -5\Delta h \leq z \leq z_0 \\ -\frac{B_{\Delta}z_0}{\Delta h(z_0 - \Delta h)}(z - \Delta h) + B_{\Delta} & \text{for } z_0 < z \leq \Delta h \end{cases} \quad (\text{A.4.5})$$

where

A_{Δ} is the cross sectional area Δh above the bottom

B_{Δ} is the channel width at the same level.

Δh is the user defined DELH.

and

$$z_0 = \Delta h - \frac{2A_{\Delta}}{7B_{\Delta}} \quad (\text{A.4.6})$$



The choice of slot description is set in the MIKE11.ini file through the variable AREA_PRESERVING_SLOT. The default setting is the classical description e.g. (A.4.3). ■

A.4.6 Constant AWR Top Slot

The constant ARW top slot is intended for closed cross sections and are vital when pressurised flow are considered, see Section 4.2.

When water enters the slot, water can still flow into the reach section, but the flow area of the cross section (and thereby the volume of water in the reach) stays the same, i.e., water disappears in the process. The water disappears when the water level rises and appears again when the water level is falls.

The argument for keeping the area constant is that the momentum term in the momentum equation contains a Q^2/A term. If A is increasing, the momentum will drop, and thereby the velocity. The velocity should not decrease when the pipe gets under pressure.



APPENDIX B

Structure Module





B.1 QH Relations Calculated for Culverts

This appendix presents details of how the discharge is calculated for culverts where the QH relations are provided by the 1D engine. These details expand on the presentation of Section 6.7.2.

B.1.1 Loss Coefficients

The contraction, expansion, friction and bend loss coefficients, and the critical flow correction coefficient are described as follows.

B.1.1.1 Entrance loss

The contraction loss coefficient, ζ_1 , is a function of the inflow loss coefficient, ζ_{in} , the culvert inflow cross section area, A_{s_1} , and the inflow river cross section area, A_1 . Typically, ζ_{in} is set to 0.5.

$$\zeta_1 = \zeta_{in} \left(1 - \frac{A_{s_1}}{A_1} \right) \quad (\text{B.1.1})$$

B.1.1.2 Expansion loss

The expansion loss coefficient, ζ_2 , is a function of the outflow loss coefficient, ζ_{out} , and the culvert outflow cross section area, A_{s_2} , and the outflow river cross section area, A_2 . Typically ζ_{out} is set to 1.0.

$$\zeta_2 = \zeta_{out} \left(1 - \frac{A_{s_2}}{A_2} \right)^2 \quad (\text{B.1.2})$$



In MIKE 11, the outflow loss coefficient, ζ_{out} , is specified in the Network editor → structures → culverts in the Headloss Factor Box. ■

B.1.1.3 Friction loss

The friction loss coefficient is calculated using the Manning formula, i.e.:

$$\zeta_f = \frac{2gLn^2}{R^{4/3}} \quad (\text{B.1.3})$$

where, L is the culvert length, n is Manning's coefficient and R is the mean hydraulic radius along the culvert. The Manning's n value depends on the interior surface of the culvert. Tables of values can be found in open channel



or closed conduit hydraulics references such as (/11/ and /22/). For a concrete culvert n would typically range from 0.011 to 0.017.

B.1.1.4 Bend and other losses

The bend loss coefficient, ζ_b , is provided for situations where headlosses other than from the above occur, for example bends, damaged culverts, trapped debris. The headloss due to ζ_b is defined in the total headloss given below. For straight culverts in good condition a value of zero would apply.

B.1.1.5 Total headloss through culvert

The total headloss, ΔH_{loss} , through the culvert is given by

$$\Delta H_{loss} = \frac{Q^2}{2g} \left(\frac{\zeta_1}{A_{s_1}^2} + \frac{\zeta_f + \zeta_b}{A_{s_a}^2} + \frac{\zeta_2}{A_{s_2}^2} \right) \quad (\text{B.1.4})$$

where, A_{s_a} is the mean cross section area along the length of the culvert, and Q is the discharge.

B.1.1.6 Critical flow correction factor

The critical and orifice flows are multiplied by the critical flow correction factor, α_c , see Section 6.1 General Flow Conditions (p. 95), for more details. Typically a value of 1.0 is used.



In MIKE 11, the critical flow correction factor, α_c , is specified in the Network editor → structures → culverts in the Headloss Factor Box as the Free Over-flow Headloss Factor. ■

B.1.2 Discharge for Critical Inflow or Outflow

In the case of either inflow or outflow being critical the discharge, Q_c , for a given critical depth is calculated as:

$$Q_c = \alpha_c A_c \sqrt{g \frac{A_c}{T}} \quad (\text{B.1.5})$$

where, A_c is the critical flow area and T is the flow width at the water surface.



B.1.3 Condition for Critical Inflow

Critical flow at the inflow to the culvert occurs when the culvert slope, S_0 , exceeds the critical flow slope, S_c , as defined by:

$$S_0 = \frac{z_{inv_1} - z_{inv_2}}{L} \quad \text{and} \quad S_c = \left(\frac{Q_c n}{A_c R_c^{2/3}} \right)^2 \quad (\text{B.1.6})$$

where, z_{inv_1} and z_{inv_2} are the inflow and outflow invert levels of the culvert, and R_c is the hydraulic radius at critical flow.

For the calculation of h_1 , the inflow water depth is taken as the critical depth. The friction losses and bend losses have no effect on the discharge for this flow condition.

B.1.4 Condition for Critical Outflow

Critical flow at the outflow to the culvert occurs when S_0 is less than S_c .

Before the calculation of h_1 can proceed, it is necessary to determine the inflow water depth. A standard backwater analysis using a fine increment in water depth is used starting with the critical flow depth at the outflow end and working upstream. The bend losses, if any, are applied at the mid-point along the length of the culvert.

In the situation of the culvert section becoming full (i.e., submerged inflow), the friction slope becomes constant and the backwater analysis adjusts accordingly.

The upstream water level is calculated based on the inflow water depth in the culvert using the iteration procedure described in Section 6.7.2.

B.1.5 Orifice Flow at Inflow

Orifice flow occurs in short or steep culverts (Figure 6.9(e)). Culverts in which this flow condition occurs are sometimes referred to as “hydraulically short” (111). The flow is similar to that which occurs under a sluice gate. The discharge is calculated as:

$$Q_0 = \alpha_c C_0 A_{full} \sqrt{2g(H_1 - z_{inv_1})} \quad (\text{B.1.7})$$

where, C_0 is the coefficient of discharge, H_1 is the inflow energy head in the river, z_{inv_1} is the inflow invert level, and A_{full} is the full cross section area of the culvert.



In MIKE11, the facility to manually specify C_0 as a function of y_1/D ($y_1 = h_1 - z_{inv_1}$ and $D =$ culvert depth) has been provided in the network editor → structures → culverts → Flow conditions under the Orifice Flow Conditions Tab. ■

It is anticipated that in most condition it will be unnecessary to provide C_0 as a default is provided (discussed below). However, it does provide the flexibility to model a “hydraulically short” culvert, or a sluice gate (zero length) in detail if sufficient information on the discharge coefficient is available. (/11/) provides a detailed analysis and tables of discharge coefficients for orifice flow and other flow conditions.

If no values for C_0 are specified, a value of 0.65 at y_1/D equal to 5.0 is adopted. When y_1/D is greater than 5.0, C_0 remains constant at 0.65, while below 5.0 a linear interpolation is made with the C_0 value calculated automatically as described in the following.

A value for C_0 is automatically calculated at the point of inflow submergence if the flow condition is inflow critical. This allows a smooth transition to occur between the two flow conditions. The point of inflow submergence is nominally adopted as 95% of the full culvert flow area. The C_0 value calculated is shown in the first row of the C_0 versus y/D tables.

B.1.6 Full Culvert Flow with Free Outflow

The complement to orifice flow at the inflow is when the culvert is defined as “hydraulically long”, i.e., the culvert is flowing full with a free outflow (Figure 6.9 (f)). In this case the discharge, Q_p is calculated as:

$$Q_p = A_{full} \sqrt{\frac{2g(H_1 - z_{obv_2})}{\zeta_1 + \zeta_f + \zeta_b + 1}} \quad (\text{B.1.8})$$

where H_1 is the inflow energy head level in the river and z_{obv_2} is the outflow soffit level (i.e. invert plus culvert depth).

The outflow energy head level in the above equation has been set to that at the outflow soffit by assuming atmospheric pressure occurs there. This assumption is compatible with the critical outflow flow condition at the point of the outflow becoming submerged as the discharge equations are the same if ζ_2 is equal to 1.0. This is important for the transition between upstream and downstream controlled flow conditions as discussed later.

B.1.7 Downstream Controlled Flow (Submerged Flow)

In the case of a downstream controlled flow the computation is complicated because of the influence of all three cross section areas along the culvert, A_{s_1} , A_{s_a} and A_{s_2} , and the mean hydraulic radius, R . The situation is further complicated in the case where the culvert outflow is close to critical flow con-



ditions as the water surface profile through the culvert in these conditions is very non-linear.

B.1.8 Partially Full Inflow and Outflow

An iterative procedure is used to determine A_{s_1} , A_{s_a} , A_{s_2} and R . The iteration is made on the water levels in the culvert at the upstream and downstream ends, Equations (B.1.9a) and (B.1.9b), from which A_{s_1} and A_{s_2} are calculated. For A_{s_a} and R , a linear interpolation of the water level at the culvert mid-point is initially used.

$$h_{s_1} = H_1 - \frac{(1 + \zeta_1)(H_1 - H_2)}{C_{a_s} A_{s_1}^2} \quad (\text{B.1.9a})$$

$$h_{s_2} = H_2 - \frac{(1 - \zeta_2)(H_1 - H_2)}{C_{a_s} A_{s_2}^2} \quad (\text{B.1.9b})$$

where

$$C_{a_s} = \frac{\zeta_1}{A_{s_1}^2} + \frac{(\zeta_f + \zeta_b)}{A_{s_a}^2} + \frac{\zeta_2}{A_{s_2}^2}$$

h_{s_1} and h_{s_2} are the water levels in the culvert at the inflow and outflow ends, while H_1 and H_2 are the inflow and outflow energy head levels in the river.

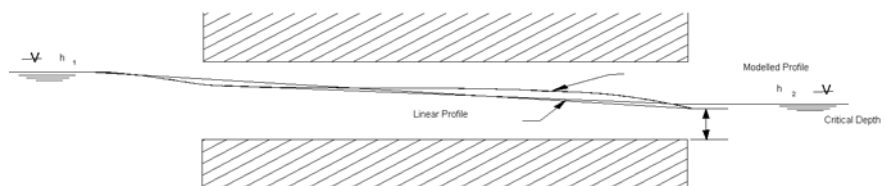

Fig B.1.1 Modelled water surface profile when actual profile is very non-linear

When the outflow is close to a critical flow state the water surface profile is highly non-linear, and the friction losses calculated from a linear interpolation will be too high (Fig B.1.1). To overcome this problem without using a computationally intensive backwater analysis in each iteration, a comparison is made with the friction losses calculated from the backwater analysis for criti-



cal outflow, see above. In the case of the losses from the backwater analysis being lower, C_{a_s} is calculated as:

$$C_{a_s} = \frac{2g}{Q_c^2} \left(H_1 - h_c - \frac{Q_c^2}{2gA_c^2} \right) + \frac{\zeta_2}{A_{s_2}^2} \quad (\text{B.1.10})$$

where the subscript c refers to the critical flow conditions based on h_1 . This also ensures a smooth transition between the outflow critical condition and submerged flow providing ζ_2 is less than or equal to 1.0.

The iterative procedure typically takes two to three iterations to converge. If the upstream and downstream water levels are changing rapidly more iterations are usually necessary with the number rarely exceeding ten. The maximum number of iterations is controlled by the Inter1Max variable.



In MIKE 11, the Inter1Max variable can be edited in the HD parameter editor →Default values. ■

B.1.9 Submerged Inflow and Partially Full Outflow

This flow condition typically occurs when the culvert slope is adverse to the water surface slope as shown in Figure 6.9(h).

The iteration procedure described above is used except that the mean cross section area is adjusted according to:

$$A_{s_a} = \frac{L_{full}}{L} A_{full} + \left(1 - \frac{L_{full}}{L} \right) \frac{A_{full} + A_{s_2}}{2} \quad (\text{B.1.11})$$

where L_{full} is the length of the culvert which is following full and L is the total length.

A similar adjustment is made to the mean hydraulic radius.

B.1.10 Partially Full Inflow and Submerged Outflow

This flow condition occurs in sloping culverts as illustrated in Figure 6.9(i). A similar procedure to that described in “Submerged Inflow and Partially Full Outflow” above is used.

B.1.11 Fully Submerged

Where the culvert is fully submerged (Figure 6.9(j)) the cross section areas and hydraulic radius are equal to those when the culvert is full.



B.1.12 Transition between Upstream and Downstream Control

Whether the flow is upstream or downstream controlled is best based on a single criteria. Using a single criteria is preferable for stability reasons and for a smooth transition between flow conditions.



Analysis of the formulations described above, assuming that ζ_2 is less than or equal to 1.0, gives the following conclusions:

- In the case of either inflow or outflow being critical, then if H_2 is below the critical water level, h_c , the flow will be critical. If H_2 is greater than h_c then the flow can be either critical or downstream controlled. The level at which the flow becomes downstream controlled is dependent on the magnitude of ζ_2 . If ζ_2 is equal to 1.0 the change to or from submerged flow will be at H_2 equal to h_c . For ζ_2 less than 1.0, which is normally the case, downstream controlled flow will occur at some point above h_c .
- Similarly, the same scenario can be shown to occur for full culvert flow and orifice flow versus fully submerged flow where h_c is taken as the outflow soffit (invert plus culvert depth).

This leads to the following criteria for selecting between upstream and downstream flow controls:

- If H_2 is less than either h_c at outflow (critical inflow or outflow) or the downstream soffit (orifice or full culvert flow) then the flow is upstream controlled, otherwise the flow condition which gives the lower discharge is selected

In the case of critical inflow, H_2 should be taken as that immediately past the point of critical flow (i.e., at the inflow to the culvert). However, for culverts of non-zero length and/or non-zero bend loss, the energy headlosses through the culvert are not known and the more conservative approach of using h_c at the outflow must be taken. A similar situation applies in the case of orifice flow.



APPENDIX C

Misc





C.1 2D Mapping, Flood Maps



Outlined below is the interpolation routine used to generate the various two dimensional maps. These maps can currently only be setup when running a MIKE 11 setup

The mapping of water levels, water depths, velocities and advection dispersion components from the one-dimensional results to two-dimensional maps are done through a number of steps:

- Interpolation of horizontal 2D cross section end point coordinates at all digitised points and all interpolated water level points.
- Mapping between the horizontal 2D (x,y) coordinate an the river coordinate system (chainage and transversal distance from centre of river).
- Linear interpolation of results in the river coordinate system can then be mapped to the 2D coordinate system.

All cells in the 2D grid can spatially interpolate a bed level, water level etc. by using the interpolation and mapping routines.

C.1.1 Interpolation of Cross Section Coordinates

The network consists of digitised points and cross sections, and the two are related by their chainage value. A typical network can be seen in Fig C.1.1. The circles illustrate the digitised points. The cross sections are shown as the full drawn lines.

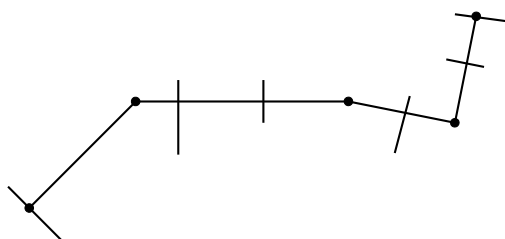

Fig C.1.1 Typical reach with digitised points and cross sections

The first step is to obtain a 2D envelope of the river system that follows the digitised points, as in Fig C.1.2

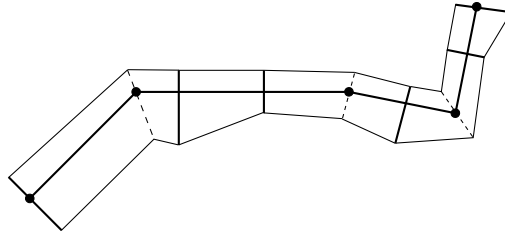

Fig C.1.2 River 2D envelope

This is obtained by considering the river as a straight line as in Fig C.1.3, which is called the river coordinate system. In this river coordinate system, the left/right river width can be interpolated at the digitised points and the interpolated water level points by linear interpolation. The interpolated cross section positions are indicated by dashed lines in the plot.

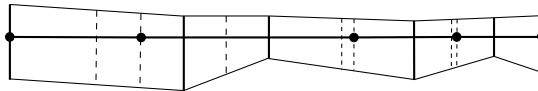

Fig C.1.3 Reach from 1D river coordinates point of view. Dashed lines are interpolated river widths at either digitised points or interpolated water level points

The interpolated widths are used at the digitised points and the interpolated water level points to obtain the 2D horizontal (x,y) coordinates of the river sides, and straight lines between the river side coordinates down the river are used to form the 2D envelope.

C.1.2 Mapping between 2D and 1D Coordinate Systems

The reach is split into a number of segments, bounded by either a digitised point or an interpolated water level point. Each segment has cross section end point coordinates at each end. An actual cross section need not exist at the end of the segments, but further up/down the river. Such a segment is termed a mapping box. Fig C.1.4 shows a mapping box in grey and bounded by the dashed lines. In this case cross sections are defined further up/down of the mapping box, indicated by full drawn lines. For each of these mapping boxes a set of local (u,v) coordinate systems are introduced on each side of the river centre line (lowest point line), Fig C.1.4 shows one. The (x,y) point in the figure marked with a circle is mapped to the local (u,v) coordinates (0,5;0,5). From this local coordinates it is possible to calculate the river coordinates, chainage and width.

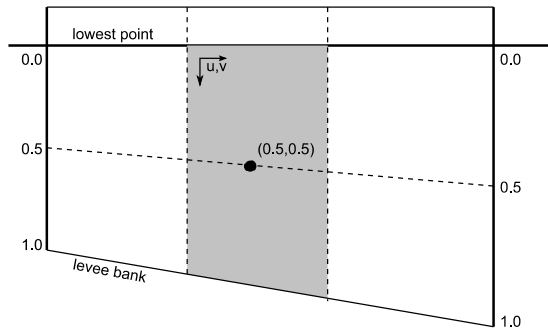

Fig C.1.4 Mapping from (x,y) to river system coordinates

For a given (x,y) coordinate, a value is calculated by first mapping the (x,y) coordinate to local (u,v) coordinate system, calculate the river coordinates, and then linearly interpolate the value in the river coordinate system.

When left and/or right bank markers are set, the local mapping needs to take place between each marker line, as in Fig C.1.5, hence up to 4 local different (u,v) mappings can take place within a mapping box. Note especially that the relative local river v coordinate differs in each end of the mapping box.

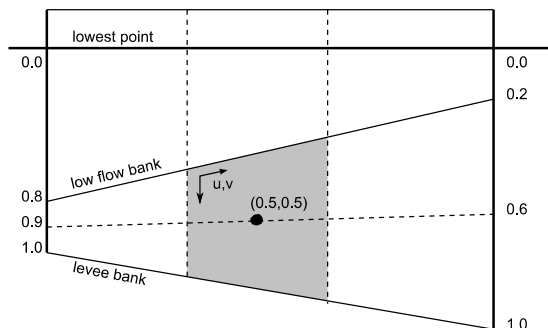

Fig C.1.5 Mapping from (x,y) to river system coordinates when bank markers are specified.

In case one of the cross sections does not define the bank marker, the quadrilateral (u,v) mapping degenerates to a triangle.

In some cases the cross sections lines in each end of a mapping box intersect. An example is shown in Fig C.1.6, where the mapping box B between point 2 and 3 has intersecting sides. The grey area B* is overlapping both the A, B and C mapping box. The B* part of the B mapping box is disregarded.

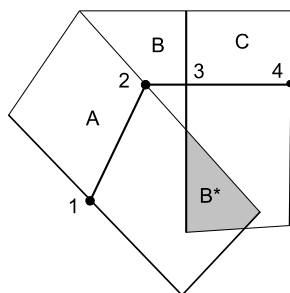

Fig C.1.6 Mapping box with intersection cross section lines. The grey B* part is ignored in the B mapping box.

C.1.3 Linear Interpolation of Results

The interpolation of results at a given grid cell in the 2D map grid depends on the type of result:

- Water levels and concentrations are interpolated between nearest h-points based on the chainage coordinate of the grid cell. Values are only shown if the water level is above the local bed level at the grid cell.
- Water depth is determined as the water level minus the bed level, and will only be shown if the value is positive.
- Velocity is interpolated between the nearest h-points, and is only shown if the water level is above the local bed level at the grid cell.

In all cases results are only provided if the cross sections are open cross sections. Closed cross sections are assumed not to contribute to the map results.

C.1.4 Calculating the Local Velocity Profile in a Grid Point

The velocity distribution in a cross section is assumed to be uniform over the depth and vary as the conveyance in the transversal direction.

The total conveyance K is in this context defined as

$$K(t) = \int_0^{b_s(t)} d(x, t)^{5/3} M(x) dx \quad (\text{C.1.1})$$

where the integration takes place along the cross section profile that is wet, b_s is the width of the cross section, d is the local water depth along the cross section and M is the Manning resistance number. The water depth varies over the cross section, and Manning's resistance number can also vary over



the cross section, but it need not do so. For the Chezy description, the $5/3$ is replaced with $3/2$ and M is replaced by the Chezy number C



The velocity for a given point in the cross section is defined by

$$v(x, t) = \frac{q(t)}{K(t)} \cdot M(x) \cdot d(x, t)^{2/3} \quad (\text{C.1.2})$$

where the q is the interpolated discharge at the cross section. For the Chezy formulation the M is again replaced by C and the $2/3$ s replaced by $1/2$.

Hereby a value for the velocity can be found at every point along the cross section, and the velocity in intermediate grid cell points in a mapping box are found by linear interpolation.

For a cross section that does not have raw data defined, or where the cross section is not fully open, above formulation can not take place or is not valid. Instead the velocity result will be just a simple average over the entire cross section and not vary along the cross section.

$$v(t) = \frac{q(t)}{A_{\text{fl}}(h(t))} \quad (\text{C.1.3})$$



APPENDIX D

Default Values in MIKE 11 and MIKE+





D.1 MIKE 11 Default Values



In MIKE 11, a number of parameters can be supplied in the “Default Values” tab of the HD Parameters file. The subset of the parameters that are supported by MIKE 1D are described here.

ALPHA Coefficient

This is the velocity distribution coefficient used in the momentum equation, see Section A.2 Solving the Saint-Venant Equations (p. 285). The default value is 1.0.

DELH Coefficient

DELH controls the depth and top elevation of the slot in low flow conditions. The slot is inserted at height DELH above the river bottom and extends to a depth $5 \times \text{DELH}$ below this level. See Section A.4.5.2 Area preserving bottom slot (p. 310). The default value is 0.1 m.

DELHS Coefficient

DELHS is used to prevent instabilities arising when the water surface gradient across a structure changes sign, see Chapter 6 on structures. It specifies the water level difference across a weir below which the flow description is linearised to obtain a stable solution. The default value is 0.01 m.

DELTA Coefficient

A forward centring of the $\partial h / \partial x$ -term in the numerical scheme has a dissipating influence which can be demonstrated using the Taylor-series, see Section A.2.5 DELTA Coefficient (p. 303). The forward centring is automatically introduced into MIKE 11 where the flow has become supercritical.

The dissipative influence of the forward centring can be controlled by the user for sub-critical flows through the coefficient DELTA ($0.5 \leq \delta \leq 1$). A value of 0.5 (the default) has no dissipative effect, while a value of 1.0 has maximum influence.

Changing the value of DELTA from its default value should only be carried out when “short term” fluctuations are unimportant, as in the case of a wave with a period of several days or longer.

FroudeExp

MIKE 1D offers two alternatives to the suppression of the convective terms in the Momentum equation for supercritical flow. If a negative value is entered for FroudeExp or FroudeMax (see below) then the default suppression is applied. FroudeExp is the exponential coefficient in the alternative suppression term.

FroudeMax

FroudeMax is the value at which the suppression sets in. As above if this is set to a negative value the default suppression is applied.



Inter1Max

This coefficient gives the maximum number of iterations permitted per time step to obtain a solution at a structure, see Section 6 Structures (p. 95). The default value is 10.

NoITER

NoITER specifies the number of iterations used in each time step to obtain a solution. The default value is 1. See Section A.2 Solving the Saint-Venant Equations (p. 285).

THETA

THETA is used in the discretisation of the momentum equation in the Fully Dynamic Wave Approximation (it is not used in the Fully Dynamic Higher Order Approximation). It can be used to dampen the instabilities from rapidly varying discharges and discharge reversals. The default value is 1.0 See Section Fully dynamic, MIKE 11 (p. 290).

Zeta Min

The headloss over structures is calculated according to Section 6 Structures (p. 95). The user has the option of specifying a minimum headloss, Zeta Min which is the lowest acceptable value of the sum of the headloss factors.



D.2 MIKE11.INI File Settings



The Mike11.ini file contains settings for MIKE 1D. The file is loaded in the MIKE 11 bridge, and as such the settings in Mike11.ini are only relevant when MIKE 1D is running MIKE 11 setups.

D.2.1 MIKE 11 HD Settings

The section describes settings that are relevant for hydrodynamic calculations.

D.2.1.1 WL_EXCEEDANCE_FACTOR

WL_EXCEEDANCE_FACTOR defines when the calculation fails if water exceeds the banks of an open cross section. The maximum allowed water in an open cross section is WL_EXCEEDANCE_FACTOR times the height of the cross section. By default, open cross sections are extended upward with vertical walls in the full width of the cross section.

Allowed values: Any positive value.

Default value: 4.0.

D.2.1.2 MAX_GATE_ITERATIONS

MAX_GATE_ITERATIONS defines the maximum allowed number of iterations during one time step in situations where the flow through structures is calculated by iterations.

Allowed values: Any positive integer.

Default value: 50.

D.2.1.3 StructureSetWaterLevelsAtTime

StructureSetWaterLevelsAtTime defines which water level to use when calculating flow through structures. One of three possible water levels are available: 0 means water level at the previous time step (time N), 1 means water level at the time between previous and next time step (time N+1/2) and 2 means water level at the next time step (time N+1).

Allowed values: 0, 1, or 2.

Default value: 2.



D.2.1.4 MaxNumberOfErrorLogFileBackups

During data reading and after the simulation MIKE 1D generates several log files and a simulation summary file. In consecutive simulations, a set of backup log and summary files is stored by assigning serial numbers to the files. The files indexed "01" are the newest, and growing index numbers indicating older files. The maximum number of the backup files stored can be controlled by setting the parameter MaxNumberOfErrorLogFileBackups.

Allowed values: Any positive value.

Default value: 3.

D.2.1.5 ControlModuleNumberOfIterations

Number of iterations in the control module. Useful if there are control definitions where the input depends on the output from the control module.

Allowed values: Any positive value.

Default value: 1.

D.2.1.6 ALTERNATIVE_CONV_SUPPR_FOR_FULLY_DYNAMIC

This flag enables an alternative momentum suppression algorithm in the momentum equation (q -grid points) in the Fully Dynamic Wave Approximation. Instead of using the maximum Froude number upstream and downstream to suppress the average momentum term, the contributions from upstream and downstream are suppressed with their respective Froude numbers. Enabling this can in some cases stabilise the simulation.

Allowed values: ON or OFF.

Default value: OFF



D.3 DHlapp.ini File Settings



The DHlapp.ini file contains settings for the 1D engine. The file is loaded in the MIKE+ bridge, and as such the settings in DHlapp.ini are only relevant when MIKE 1D is running MIKE+ setups.

D.3.1 MIKE+ HD Settings

The Section describes settings that are relevant for hydrodynamic calculations.

D.3.1.1 BRANCH_MIN_L

Allowed values: Any positive value.

Default value: 10.

D.3.1.2 NODE_SLOT_WIDTH

Allowed values: Any positive value.

Default value: 0.01.

D.3.1.3 RESERVOIRHEIGHT

Allowed values: Any positive value.

Default value: 5.

D.3.1.4 RESERVOIRWIDTHFACTOR

Allowed values: Any positive value.

Default value: 1000.

D.3.1.5 FLOODLIMIT

Maximum water depth above ground in nodes. Used for both manholes and basins. An error will be generated if the water level exceeds ground level plus FLOODLIMIT.

Allowed values: Any positive value.

Default value: 10.



D.3.1.6 IMPLICIT_PUMP

Allowed values: 0 (False), 1 (True).

Default value: 0.

D.3.1.7 IMPLICIT_ORIFICE

Allowed values: 0 (False), 1 (True).

Default value: 1.

D.3.1.8 IMPLICIT_WEIR

Allowed values: 0 (False), 1 (True).

Default value: 1.

D.3.1.9 IMPLICIT_VALVE

Allowed values: 0 (False), 1 (True).

Default value: 1.

D.3.1.10 MAX_LOG_FILE

During data reading and after the simulation MIKE 1D generates several log files and a simulation summary file. In consecutive simulations, a set of backup log and summary files is stored by assigning serial numbers to the files. The files indexed "01" are the newest, and growing index numbers indicating older files. The maximum number of the backup files stored can be controlled by setting the parameter MAX_LOG_FILE.

Allowed values: Any positive value.

Default value: 3.

D.3.1.11 ALLOW_MANY_GP_IN_RM

If 0 (false), then pressure reaches (also called pressure mains) have only three grid points (H-Q-H). If 1 (true), then grid points are assigned with the same algorithm as used for normal reaches.

Allowed values: 0 or 1

Default value: 0(false)



D.3.1.12RM_CONV_FACTOR

Width of top slot in pressure reach (also called pressure mains) grid points.

Allowed values: Any positive value.

Default value: 0.001

D.3.1.13WriteSurfaceFloodResults

If true, then the table of nodes in the summary is appended with “Flooding Duration” to show the total time that a node is flooded. Also, the ADDOUT.res1d file is appended with three items: “Water Flow Rate Above Ground”, “Water Volume Above Ground”, and “Spill Discharge”.

Allowed values: 0 (False), 1 (True).

Default value: 0 (False)

D.3.2 MIKE+ Rainfall Runoff Settings

D.3.2.1 IntegratedHorton

Allowed values: 0, 1, 2, 3.

Default value: 0.

D.3.2.2 RUNOFF_B_DRYDEPTHMM

Allowed values: Any positive value.

Default value: 0.001.

D.3.2.3 NL_CONCEPT_DRYDEPTH

Allowed values: Any positive value.

Default value: 0.001.

D.3.2.4 RUNOFF_B_LOW_FLOW

Allowed values: Any positive value.

Default value: 0.0001.



D.3.2.5 RUNOFF_A_INITLOSS_RECOVER

Allowed values: Any positive value.

Default value: 0.00005.

D.3.2.6 RUNOFF_B_INITLOSS_RECOVER

Allowed values: Any positive value.

Default value: 0.00005.

D.3.2.7 RUNOFF_B_DT_DRY

Allowed values: Any positive value.

Default value: 12.

D.3.2.8 RUNOFF_C_INITLOSS_RECOVER

Allowed values: Any positive value.

Default value: 0.00005.

D.3.2.9 RUNOFF_B_EVAPORATION

Allowed values: OFF, ON.

Default value: OFF.

D.3.2.10NON_RETURN_VALVE_STARTUP_PERIOD

Allowed values: Any positive value.

Default value: 60 seconds.



INDEX

**Symbols**

| | |
|------------------------------|----|
| "AD" Courant check | 84 |
| "HD" Courant check | 84 |

A

| | |
|---------------------------------------|---------|
| Adaptive time step size | 80 |
| Additional boundary source | 87, 90 |
| Angle wall top slot | 45 |
| Application time | 93 |
| Area preserving bottom slot | 47, 310 |

B

| | |
|---|--------|
| Bottom level | 19, 21 |
| Boundaries | |
| Discharge as function of time | 294 |
| Water level as a function of time | 294 |
| Boundary node | 17 |
| Branch | 15 |
| Bridges | 137 |
| Piers | 141 |

C

| | |
|--|---------|
| Calculated effective node area | 65 |
| Calibration of resistance | 30 |
| Canal | 15 |
| Chainage | 15 |
| Circular pipe | 26 |
| Classical bottom slot | 47, 310 |
| Colebrook-White formulation | 32 |
| composite structure | 97 |
| Computational grid | |
| Area selection | 22 |
| Branch selection | 22 |
| Constant ARW top slot | 45 |
| Continuity equation | 50 |
| Hydrodynamic | 286 |
| Control structures | 119 |
| Drowned flow | 126 |
| Free flow | 125 |
| Overflow | 124 |
| Underflow | 124 |
| Convection suppression factor | 55 |
| Critical level | 19 |
| Culvert | 110 |
| Culverts | |
| Full flow | 318 |
| Fully submerged | 320 |

| | |
|---|----------|
| Loss coefficients | 315 |
| Partially full | 319, 320 |
| Submerged flow | 318 |
| Transition up-/downstream controlled flow | 321 |
| Culverts, Q-h Relations Calculated | |
| Closed/Open section switch | 117 |
| Construction of Q-h relationships | 115 |
| Flooded areas | 117 |
| Flow descriptions | 113 |
| Specification | 113 |
| Velocities | 117 |

D

| | |
|---|----------|
| Dambreak Structure | |
| Breach geometry | 128 |
| Erosion based breach development | |
| 128, | 129 |
| Flow calculations | 133 |
| Known breach development | |
| geometry | 128 |
| Limiting cross-section | 133 |
| Piping failure | 129, 130 |
| Darcy-Weisbach | 32 |
| Diffusive wave | 53, 289 |
| Digi points | 17 |
| Direction of natural flow | 16 |
| Distributed source boundaries | 91 |
| Distribution types | 91 |
| double sweep algorithm | 53 |
| Downstream | 16 |

E

| | |
|--|-----|
| Effective area | 36 |
| Effective flow area, node headloss | 58 |
| Egg-shaped | 26 |
| Energy loss | 57 |
| Energy loss coefficient | 98 |
| Equivalent grain diameter | 32 |
| Explicit Manning | 291 |
| External structure | 97 |

F

| | |
|--------------------------|----|
| Flow direction | 18 |
| Flush out | 76 |
| Flush-in | 76 |
| Free outflow | 89 |



| | |
|---|----------|
| Free overflow | 98 |
| Free overflow formulation | 98 |
| G | |
| Global source boundaries | 92 |
| Grid points | 17 |
| Ground level | 19, 21 |
| Ground Water Leakage | 92 |
| H | |
| Hotstart | 76 |
| hydraulic jump | 50 |
| Hydrodynamic default parameters | |
| ALPHA | 333 |
| DELH | 333 |
| DELHS | 333 |
| DELTA | 303, 333 |
| FroudeExp | 333 |
| FroudeMax | 333 |
| Inter1Max | 334 |
| Nolter | 334 |
| Zeta Min | 334 |
| I | |
| Implicit Manning | 291 |
| Inflow boundary | 88 |
| Invert level | 12, 19 |
| J | |
| Junction node | 16 |
| K | |
| Kinematic wave | 53, 290 |
| L | |
| Lateral inflow | 23 |
| lateral inflow | 88 |
| Left coordinate marker | 28 |
| Left levee bank | 28 |
| Left low flow bank | 28 |
| Link | 15 |
| Local initial conditions | 75 |
| Location, reach | 16 |
| Low flow conditions | 69 |
| Slot | 69 |
| Zero flow | 70 |
| Lowest point | 28 |
| M | |
| Manning formulation | 30 |
| Markers | 28 |
| Mass equation | 50 |
| Minimum water depth | 75 |
| Momentum equation | 50 |
| Discretisation | 288 |
| Multi zone resistance | 35 |
| N | |
| NAM | |
| Accumulation and melting of snow | 177 |
| Adjustment of temperature and precipitation to altitude zones | 180 |
| Altitude-distributed snowmelt model | 178 |
| Base temperature (snow/rain) T0 | 193 |
| Baseflow | 175 |
| Baseflow time constant CKBF | 190 |
| Basic modelling components | 172 |
| Capillary flux | 176 |
| Crop coefficients and irrigation losses | 194 |
| Degree-day coefficient C _{snow} | 193 |
| Evapotranspiration | 173 |
| Extended groundwater components | 175 |
| Extended snow melt components | 182 |
| Groundwater depth for unit capillary flux GWLFL1 | 191 |
| Groundwater recharge | 175 |
| Infiltration factor K0 _{inf} | 193 |
| Initial conditions | 195 |
| Interflow | 174 |
| Interflow and overland flow routing | 174 |
| Irrigation module | 183 |
| Lower groundwater storage | 175 |
| Lower zone or root zone storage | 173 |
| Maximum groundwater depth causing baseflow GWLBFO | 191 |
| Maximum water content in root zone storage L _{max} | 187 |
| Maximum water content in surface | |



| | |
|--|--------|
| storage Umax | 187 |
| Overland flow | 173 |
| Overland flow runoff coefficient CQOF | 188 |
| Radiation coefficient Crad | 193 |
| Rainfall degree-day coefficient Crain 193 | |
| Ratio of groundwater catchment to topographical catchment area Carea 191 | |
| Recharge to lower groundwater stor- age CQLow | 190 |
| Root zone threshold value for ground- water recharge TG | 190 |
| Root zone threshold value for interflow TIF | 190 |
| Root zone threshold value for over- land flow TOF | 189 |
| Shallow groundwater reservoir description | 176 |
| Snow module | 177 |
| Specific yield SY | 191 |
| Structure of the altitude-distributed snowmelt module | 179 |
| Structure of the irrigation module | 183 |
| Surface storage | 172 |
| Time constant for interflow CKIF . | 188 |
| Time constant for routing interflow and overland flow CK12 | 188 |
| Time constant for routing lower base- flow CKlow | 190 |
| Natural flow | 78 |
| Negative flow direction | 18 |
| Node | 16 |
| Node infiltration boundary | 91 |
| numerical water | 309 |
| O | |
| Open boundary conditions | 87, 88 |
| Orifice | 105 |
| O-shaped | 26 |
| Outlet | 21, 88 |
| Overflow Formula | 97 |
| Overflow formula | 98 |
| P | |
| Pipe | 15 |
| Point source boundaries | 90 |
| Positive flow direction | 18 |
| Pre-defined cross section | 26 |
| Pressure reach | 51 |
| pressure reach tail node | 51 |
| Pressurized flow | 50 |
| Processed data | 25 |
| Processing of raw data | 36 |
| Processing specification | 36 |
| Pump | 102 |
| Q | |
| QH Boundary | 294 |
| QH boundary | 89 |
| QH structure | 101 |
| R | |
| Raw data | 25 |
| Reach | 15 |
| Rectangular pipe | 26 |
| Reduced calculated effective node area | 65 |
| Relative resistance | 30 |
| reservoir | 97 |
| Resistance radius | 38 |
| Reverse reach | 18 |
| Right coordinate marker | 28 |
| Right levee bank | 28 |
| Right low flow bank | 28 |
| S | |
| Saint Venant equations | 49 |
| Conservation of mass | 279 |
| Conservation of momentum | 279 |
| Shallow Water equations | 49 |
| Soft start | 94 |
| Special Weir | 101 |
| special weir | 101 |
| Structures | |
| Determination of flow regime | 302 |
| Submerged Overflow | 100 |
| T | |
| Tabulated structure | 102 |
| THETA | 334 |
| Topographical factor | 78 |
| Total value distribution type | 91 |



Index

| | |
|----------------------------------|----|
| Total wetted node area | 65 |
| Triple zone resistance | 36 |

U

| | |
|--------------------|----|
| Upstream | 16 |
|--------------------|----|

V

| | |
|--|-----|
| Value per area distribution type | 91 |
| Value per length distribution type | 91 |
| Valve | 104 |
| velocity condition | 80 |
| Vertical wall top slot | 45 |

W

| | |
|--------------------------------|----|
| Wetted perimeter | 37 |
| Wind friction factor | 78 |

