

MIKE 21
Tidal Analysis and Prediction Module
Scientific Documentation



DHI headquarters

Agern Allé 5
DK-2970 Hørsholm
Denmark

+45 4516 9200 Telephone

+45 4516 9333 Support

+45 4516 9292 Telefax

mike@dhigroup.com

www.mikepoweredbydhi.com

PLEASE NOTE

COPYRIGHT

This document refers to proprietary computer software, which is protected by copyright. All rights are reserved. Copying or other reproduction of this manual or the related programmes is prohibited without prior written consent of DHI. For details please refer to your 'DHI Software Licence Agreement'.

LIMITED LIABILITY

The liability of DHI is limited as specified in your DHI Software License Agreement:

In no event shall DHI or its representatives (agents and suppliers) be liable for any damages whatsoever including, without limitation, special, indirect, incidental or consequential damages or damages for loss of business profits or savings, business interruption, loss of business information or other pecuniary loss arising in connection with the Agreement, e.g. out of Licensee's use of or the inability to use the Software, even if DHI has been advised of the possibility of such damages.

This limitation shall apply to claims of personal injury to the extent permitted by law. Some jurisdictions do not allow the exclusion or limitation of liability for consequential, special, indirect, incidental damages and, accordingly, some portions of these limitations may not apply.

Notwithstanding the above, DHI's total liability (whether in contract, tort, including negligence, or otherwise) under or in connection with the Agreement shall in aggregate during the term not exceed the lesser of EUR 10.000 or the fees paid by Licensee under the Agreement during the 12 months' period previous to the event giving rise to a claim.

Licensee acknowledge that the liability limitations and exclusions set out in the Agreement reflect the allocation of risk negotiated and agreed by the parties and that DHI would not enter into the Agreement without these limitations and exclusions on its liability. These limitations and exclusions will apply notwithstanding any failure of essential purpose of any limited remedy.

CONTENTS

MIKE 21 Tidal Analysis and Prediction Module Scientific Documentation

1	Introduction	1
2	Scientific Background	2
2.1	General.....	2
2.2	Tide Generating Forces and Tidal Potential	6
2.3	Doodson's Development	11
2.4	Astronomical Argument and Greenwich Phase Lag	13
2.5	Satellite Constituents and Nodal Modulation	15
2.6	The Representation of Tidal Currents.....	17
3	Some Criteria of Application.....	21
3.1	General.....	21
3.2	Selection of Constituents	24
3.3	Inference	31
4	Program Description.....	32
4.1	IOS Method	32
4.1.1	General introduction	32
4.1.2	Time series representation.....	32
4.1.3	Rayleigh criterion.....	33
4.1.4	Step-by-step calculation	34
5	Analyses of Tidal Height	35
5.1	Analysis of Tidal Height using the Admiralty Method.....	35
5.2	Analysis of Tidal Height using the IOS Method.....	39
6	Acknowledgement	45
7	References.....	46

APPENDICES

APPENDIX A
Constituent Data Package

APPENDIX B
Glossary

1 Introduction

The present manual is intended for the user of the tidal analysis and prediction programs included in the MIKE 21 Toolbox.

These programs constitute a necessary tool when dealing with coastal engineering problems, in particular regarding the definition of boundary conditions and the calibration and validation of hydrodynamic models, as well as the long-term prediction of tidal levels and currents. They are also fundamental for the interpretation of large-scale circulation processes, through the calculation of co-tidal and co-range lines and the analysis of the individual propagation of tidal constituents across the study zones.

The programs are based on some of the most advanced works on tidal analysis (Doodson, Godin) and include facilities for nodal modulation of the effects of satellites on the main constituents and for inference of the main tidal constituents that cannot be included in the analysis due to the duration of the record. The Rayleigh criterion is used for the selection of constituents from a standard data package composed by 69 constituents, 45 of which are of astronomical origin. Additionally, 77 shallow water constituents can be requested. The amplitudes and phases are calculated via a least squares method, which enables the treatment of records with gaps. For the calculation of frequencies, nodal factors and astronomical arguments, the program is based on Doodson's tidal potential development and uses the reference time origin of January 1, 1976 for the computation of astronomical variables.

As an option to the above-described general approach, programs based on the Admiralty Method have also been implemented. In this method only the four main constituents M_2 , S_2 , O_1 and K_1 are explicitly considered, and corrective factors are allowed to take into account the effects of a number of astronomical and shallow water generated constituents.

The necessary scientific background for the practising engineer is given in Chapter 2, which is supplemented by a glossary of terms on tidal theory, included at the end of the manual.

Criteria of application are discussed in Chapter 3, with particular emphasis on the choice of constituents and on the interpretation of the inference of constituents.

The description of the programs is presented in Chapter 4. The Tidal Analysis and Prediction Module of MIKE 21 comprises the following four complementary programs for the analysis and prediction of tidal heights and currents:

TIDHAC	-	Analysis of tidal heights
TIDCAC	-	Analysis of tidal currents
TIDHPC	-	Prediction of tidal heights
TIDCPC	-	Prediction of tidal currents.

In Chapter 5 examples of Analyses of Tidal Height using both the Admiralty and the IOS Method are given.

Finally, Chapter **Error! Reference source not found.** demonstrates examples of Predictions of Tidal Height using both Admiralty and the IOS Method.

2 Scientific Background

2.1 General

Understanding the principal processes involved in the generation and propagation of ocean tides is fundamental for the appropriate application of programs for the analysis of tidal heights and currents, as well as for the interpretation and use of the calculated tidal constituents. The present chapter intends to give the basic scientific background for the user of the Tidal Analysis and Prediction Module of MIKE 21. More detailed and advanced accounts can be found in the references listed at the end of this manual. For those not familiar with the specific terminology of tides commonly employed and used in this manual, a glossary of terms is also included.

Oceanic tides are generated by the combined effects of the gravitational tractive forces due to the moon and the sun (according to Newton's law of gravitation), and of the centrifugal forces resulting from the translation of the earth around the centres of gravity of the earth-moon and earth-sun systems. The resultants of these forces over the whole earth balance each other. However, their distribution over the earth's surface is not uniform, as shown in Figure 2.1 (a), the resultant at each point being the effective tide generating force. The horizontal constituent of these forces is the main agent in connection with the generation of tides, and is according to Doodson and Warburg (1941) called the tractive force, whose distribution is presented in Figure 2.1 (b).

The tide generating forces are periodic, with periods determined by the celestial movements of the earth-moon and earth-sun systems¹. The main species of tidal constituents can be summarised as follows:

- Semi-diurnal constituents that are a consequence of the earth's rotation, causing two high waters and two low waters to occur during one complete revolution at a certain place on the surface. The lunar principal constituent, M_2 , represents the tide due to a fictitious moon circling the equator at the mean lunar distance and with constant speed. In a similar way, we can define the solar principal constituent, S_2 . The deviations of the real movements with respect to the regular orbits of the fictitious celestial bodies above considered (e.g. deviations in distance, speed and eccentricity) are accounted for through the introduction of additional semi-diurnal constituents (e.g. N_2 , K_2).

¹ According to Laplace in *Celestial Mechanics*, the water surface movements, under the influence of a periodic force, are also periodic and have the same period of the acting force.

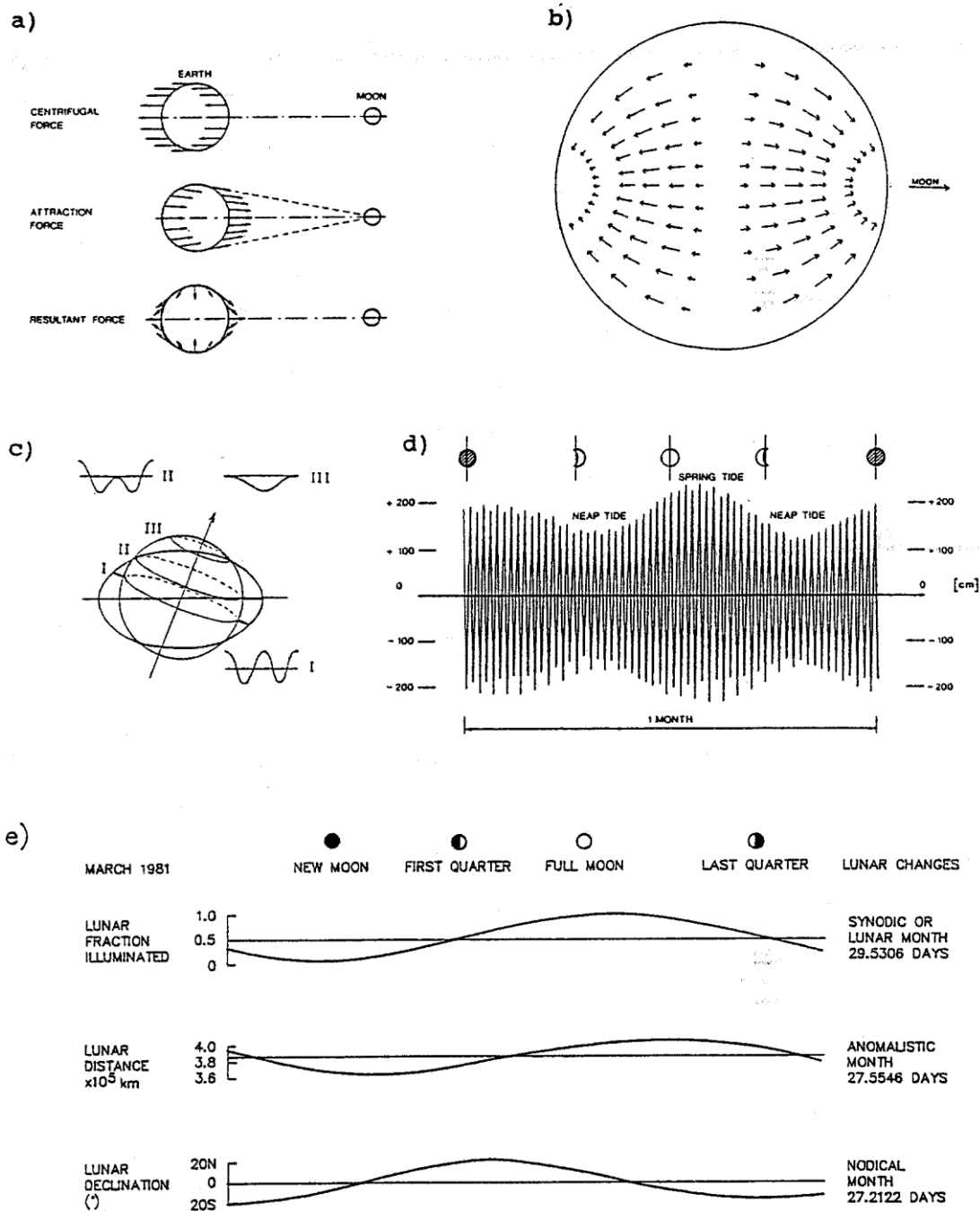

Figure 2.1 Ocean tides. a) Tide generating forces; b) Tractive forces; c) Influence of the declination of the moon/sun; d) Influence of the relative position of the moon and the sun e) lunar changes: fraction illuminated, distance and declination

- Diurnal constituents that are explained by the declination of the moon and the sun, and account for the important differences many times observed between two successive high or low waters, Figure 2.1 (c).

The periods and relative amplitudes of the main tide constituents that account for 83% of the total tide generating force (Doodson, 1941) are presented in Table 2.1.

Table 2.1 Main tidal constituents

Constituents		Period (hrs)	Amplitude (M ₂ =100)
Name	Symbol		
Principal Lunar	<i>M</i> ₂	12.42	100.0
Principal Solar	<i>S</i> ₂	12.00	46.6
Larger Elliptical Lunar	<i>N</i> ₂	12.66	19.2
Luni-Solar Declinational	<i>K</i> ₂	11.97	12.7
Luni-Solar Declinational	<i>K</i> ₁	23.93	58.4
Principal Lunar	<i>O</i> ₁	25.82	41.5
Principal Solar	<i>P</i> ₁	24.07	19.4

The relative position of the earth, the moon and the sun is responsible for the fortnight variations observed in the tidal ranges that reach a relative maximum (spring tides) when the three bodies are closest to be in line (new moon and full moon), and a relative minimum (neap tides) when the lunar and solar forces are out of phase and tend to cancel (first and last quarter), as it is shown in Figure 2.1 (d). The spring-neap tidal cycles are not produced by a specific tide generating force, but by the combined effects of the *M*₂ and *S*₂ constituents that are associated with the apparent movements of the moon and the sun. This can be easily verified by considering the water level variation due to the constituents *M*₂ and *S*₂ that can be expressed by

$$h(t) = \cos(\omega_{M_2}t) + \cos(\omega_{S_2}t) \tag{2.1}$$

considering unit amplitudes and that there is no phase difference at the adopted time reference. Using a trigonometric transformation, we get

$$h(t) = a(t)\cos\left(\frac{\omega_{M_2}t + \omega_{S_2}t}{2}\right) \tag{2.2}$$

where

$$a(t) = \left| 2\cos\frac{\Delta\omega t}{2} \right| \tag{2.3}$$

and

$$\Delta\omega = \omega_{S_2} - \omega_{M_2} \tag{2.4}$$

which shows that the superposition (without interaction) of the two semidiurnal constituents is still a semidiurnal wave with a frequency given by the average of the frequencies of the original waves and an amplitude that varies as a function of $\Delta\omega$ (it can be shown that for two generic constituents of amplitudes *a*₁ and *a*₂, the amplitude of the modulated wave varies between the sum - the constituents are in phase - and the

difference - the constituents are in opposition - of the amplitudes of the original waves). The period of the compound wave will then be given by

$$T = \frac{2\pi}{\Delta\omega} \quad (2.5)$$

which considering that $\omega_{M2} = 1.405144E-4$ rad/s and $\omega_{S2} = 1.45441E-4$ rad/s, is found to be $T = 14.761$ days, i.e. approximately half of the synodic or lunar month, that is the time between two successive new or full moons. In practice, the observed spring and neap tides lag the maximum and minimum of the tidal forces, usually by one or two days.

The tidal cycles are also dependent on the variation of distance along the elliptical orbits (the forces are higher at the apogee and aphelion than at the perigee and perihelion), and on the variation of the declinations of the moon and the sun (the diurnal tides increase with the declination, while the semidiurnal tides reach a maximum when the declination is zero). For example during a lunar synodic period, the two sets of spring tides usually present different amplitudes, Figure 2.1 (d). This difference is due to the varying lunar distance. One complete cycle from perigee to perigee takes an anomalistic month of 27.6 days, the corresponding tide generating forces varying by $\pm 15\%$. It is also interesting to refer that during the equinoxes, March and September, due to the small declination of the sun, the solar semidiurnal forces are maximised, with the result that spring tidal ranges usually are significantly larger than average spring tidal ranges; those tides are called equinoctial spring tides.

It is also important to mention that the plane of motion of the moon is not fixed, rotating slowly with respect to the ecliptic. The ascending node at which the moon crosses the ecliptic from south to north moves backwards along the ecliptic at a nearly uniform rate of 0.053° per mean solar day, completing a revolution in 18.61 years. These movements can be completely modelled through the introduction of additional constituents with different amplitudes and angular speeds. Nevertheless for their characterisation the analysis of a long period of 18.61 years would be necessary, which is for most cases impracticable. This leads to the use of correction terms that account for the effect of those constituents, which therefore originally are called nodal correction factors.

Finally, the two alternative reference systems currently used to define the astronomical co-ordinates are briefly presented (Figure 2.2). For a terrestrial observer a natural reference system consists in expressing the position of a celestial body in terms of its angular distance along the equator from the Vernal equinox, the right ascension, together with its angular distance north and south of the equator measured along the meridian, the declination. This system is called the equatorial system.

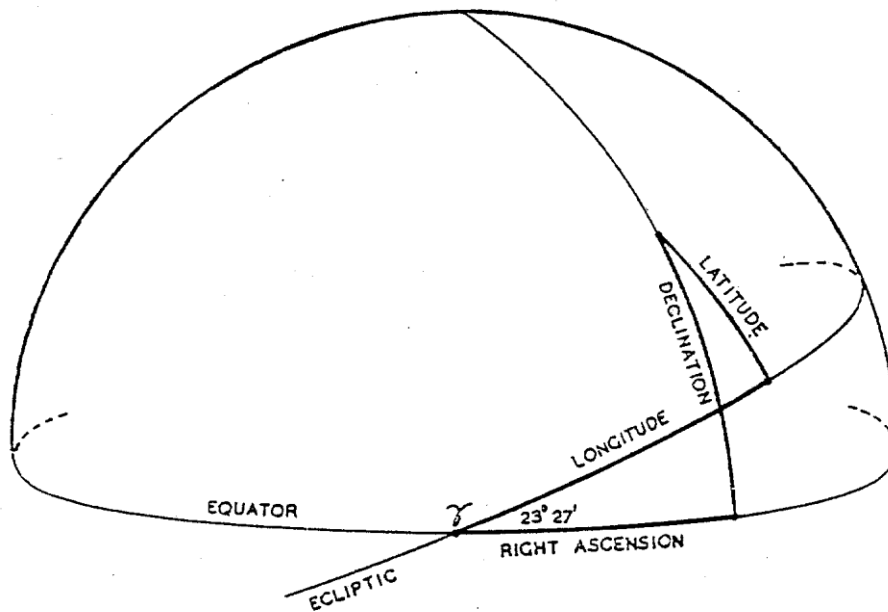

Figure 2.2 Astronomical angular co-ordinates

The plane of the earth's revolution around the sun can also be used as a reference. The celestial extension of this plane, which is traced by the sun's annual apparent movement, is called the ecliptic. The point on this plane chosen as a zero reference is also the Vernal equinox. The position of a celestial body is defined in this system by its longitude, which is the angular distance eastward along the ecliptic, measured from the Vernal equinox, and by its latitude, measured positively to the north of the ecliptic along a great circle cutting the ecliptic at right angles.

2.2 Tide Generating Forces and Tidal Potential

As described in the previous chapter, the tide generating forces are given by the resultant of the forces of attraction, due to the moon and the sun, and of the centrifugal forces due to the revolution of the earth around the centres of gravity of the earth-moon and earth-sun systems.

Consider the earth-moon system and a particle of mass m located at P_1 on the earth's surface, as shown in Figure 2.3.

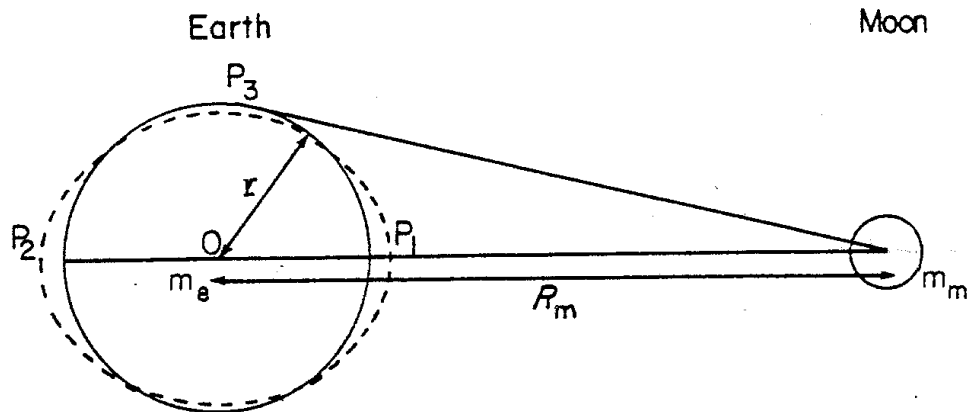

Figure 2.3 Diagram of the earth-moon system

According to Newton's law of gravitation, the force of attraction at P_1 is given by

$$F_a = G \frac{m m_m}{(R_m - r)^2} \tag{2.6}$$

where G is the gravitational universal constant, ($6.67 \cdot 10^{-11} \text{ Nm}^2\text{Kg}^{-2}$).

Because all points of the earth travel around the centre of mass of the earth-moon system in circles, which have the same radius, the distribution of the centrifugal forces is uniform. Noting also that at the centre of gravity of the earth the centrifugal and attraction forces have to balance each other, it is immediate to conclude that the centrifugal forces are given by

$$F_c = G \frac{m m_m}{R_m^2} \tag{2.7}$$

The tide generating force, F_t , at P_1 will then be²

$$F_t = F_a - F_c = \frac{2 G m m_m r}{R_m^3} \tag{2.8}$$

which gives a net force towards the moon.

Similar considerations show that for a particle at P_2 the gravitational attraction is too weak to balance the centrifugal force, which gives rise to a net force away from the moon with the same intensity as the force at P_1 . It is also easy to prove that the net force at P_3 is directed towards the centre of the earth, with half the intensity of the tide generating forces acting at P_1 and P_2 . This originates an equilibrium shape (assuming static conditions) which is slightly elongated along the direction defined by the centres of the moon and of the earth.

² In the derivation of this result the approximation $\left(1/(1 - r/R_m)^2 = 1 + 2r/R_m\right)$ has been used, since $(r/R_m)^2 \ll 1; (r/R_m \approx 1/60)$

Instead of working directly with the tide generating forces it is advantageous to use their gravitational potential which, being a scalar property, allows simpler mathematical manipulation. A potential function Ω is thus defined through the relationship

$$\vec{F} = -\vec{\nabla}\Omega \tag{2.9}$$

The gravitational potential created at a distance R by a particle of mass M is then

$$\Omega = -G\frac{M}{R} \tag{2.10}$$

which is in accordance with Newton's law of gravitation, as it can easily be seen in

$$\vec{F} = -\vec{\nabla}\Omega = G\frac{M}{R^2}\vec{i}_r \tag{2.11}$$

Considering the location of the generic point P on the earth's surface (Figure 2.4), the gravitational potential can be written in terms of the lunar angle φ , the radius of the earth r and the distance R_m between the earth and the moon, resulting in

$$\Omega = -\frac{Gm_m}{MP} = -\frac{Gm_m}{R_m} \left(1 - 2\frac{r}{R_m} \cos \varphi + \frac{r^2}{R_m^2} \right)^{-1/2} \tag{2.12}$$

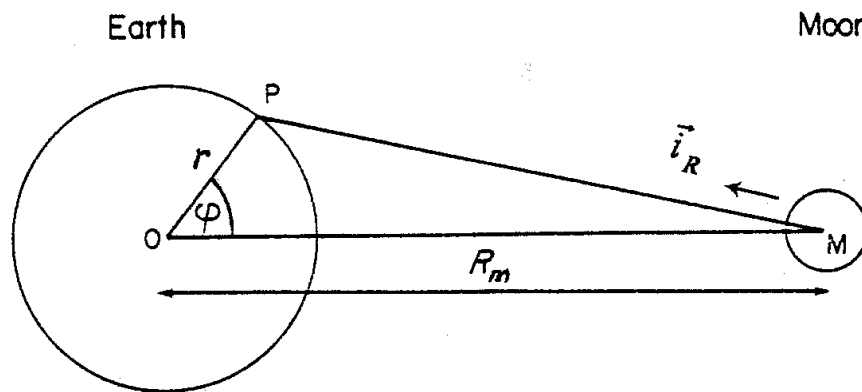

Figure 2.4 Location of point P on earth's surface

which can be expanded as

$$\Omega = -\frac{Gm_m}{R_m} \left(1 + \frac{r}{R_m} L_1 + \frac{r^2}{R_m^2} L_2 + \frac{r^3}{R_m^3} L_3 + \dots \right) \tag{2.13}$$

where the terms L_n are Legendre polynomials given by

$$L_1 = \cos \varphi \tag{2.14}$$

$$L_2 = \frac{1}{2} (3 \cos^2 \varphi - 1) \tag{2.15}$$

$$L_3 = \frac{1}{2} (5 \cos^3 \varphi - 3 \cos \varphi) \tag{2.16}$$

The first term in Equation (2.13) is constant and so has no associated force. The second term generates a uniform force parallel to OM , which is balanced by the centrifugal force. This can be easily confirmed by differentiating with respect to $r \cos \varphi$

$$-\frac{\partial \Omega}{\partial (r \cos \varphi)} = -G \frac{m_m}{R_m^2} \tag{2.17}$$

The third term is the major tide generating term. The fourth and higher terms may be neglected because $r/R_m \approx 1/60$. The effective tide generating potential can therefore be written as

$$\Omega = -G m_m \frac{r^2}{R_m^3} (3 \cos^2 \varphi - 1) \tag{2.18}$$

It is convenient to express the lunar angle φ in suitable astronomical variables as shown in Figure 2.5, which are:

- the declination of the moon north of the equator, d_m
- the north latitude of P , φ_p
- the hour angle of the moon C_m , which is the difference in longitude between the meridian of P and the meridian of the sub-lunar point V .

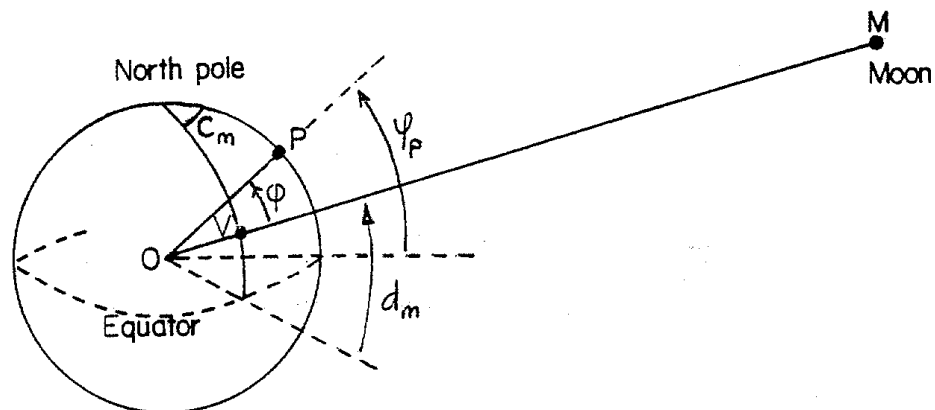

Figure 2.5 Location of P using astronomical variables

These angles can be related through the spherical formula

$$\cos \varphi = \sin \varphi_p \sin d_m + \cos \varphi_p \cos d_m \cos C_m \quad (2.19)$$

Substituting this relation in (2.18) and considering that the sea surface is normal to the resultant of the earth's gravity and of the tidal generating forces, Equation (2.18) becomes

$$\xi = r \frac{m_m}{m_c} \left[C_0(t) \left(\frac{3}{2} \sin^2 \varphi_p - 1/2 \right) + C_1(t) \sin 2\varphi_p + C_2(t) \cos^2 \varphi_p \right] \quad (2.20)$$

where ξ is the elevation of the free surface and the time dependent coefficients are given by

$$C_0(t) = \left(\frac{r}{R_m} \right)^3 \left(\frac{3}{2} \sin^2 d_m - 1/2 \right) \quad (2.21)$$

$$C_1(t) = \left(\frac{r}{R_m} \right)^3 \left(\frac{3}{4} \sin^2 2d_m \cos C_m \right) \quad (2.22)$$

$$C_2(t) = \left(\frac{r}{R_m} \right)^3 \left(\frac{3}{4} \cos^2 2d_m \cos 2C_m \right) \quad (2.23)$$

This is the equation of the Equilibrium Tide, which can be defined as the elevation of the sea surface that would be in equilibrium with the tidal forces if the earth were covered with water to such a depth that the response to the tidal generating forces would be instantaneous.

The three coefficients characterise the three main species of tidal constituents:

- The long-period species, which constituents are generated by the monthly variations in lunar declination d_m . It has a maximum amplitude at the poles and zero amplitude at latitudes $35^\circ 16'$, north and south of the equator.
- The diurnal species, includes the constituents with frequencies close to one cycle per day ($\cos C_m$), and is modulated at twice the frequency of the lunar declination, with the maximum amplitude happening when the declination is a maximum. Spatially it has maximum amplitude at 45° latitude and zero amplitude at the equator and the poles, the variations north and south of equator being in opposite phase.
- The semidiurnal species, includes the constituents with a frequency close to two cycles per day ($\cos^2 C_m$), and is also modulated at twice the frequency of the lunar declination, but has a maximum amplitude when the declination is zero (equator), and zero amplitude at the poles.

The Equilibrium Tide due to the sun can be represented in an analogous form to Equation (2.20), with m_m , R_m and d_m replaced by m_s , R_s and d_s . The resulting amplitudes are smaller than those of the lunar tides by a factor of 0.46, but the essential interpretations are the same.

The Equilibrium Tide theory is a basis for the definition of the harmonic frequencies by which the energy of the observed tides is distributed, and is also important as a reference

for the observed phases and amplitudes of the tidal constituents. Its practical use is based on Doodson's development and on the astronomical variables described in the following section.

2.3 Doodson's Development

Doodson (1921) used the following astronomical variables in his development of the tidal potential:

$s(t)$	the mean longitude of the moon
$h(t)$	the mean longitude of the sun
$p(t)$	the longitude of the lunar perigee
$N'(t)$	the negative of the longitude of the ascending node N
$p'(t)$	the longitude of the perihelion.

These longitudes are measured along the ecliptic eastward from the mean Vernal equinox.

Doodson rewrote the tidal potential considering the first four polynomials in equation (2.13) and substituting for the above variables in the equivalent of equation (2.20), arriving to the following general expression

$$\begin{aligned} \Omega_T = \Omega_m \Omega_s = & \\ & \sum_{i_o=0}^3 [G_{i_o}(\varphi) \sum_{j_o k_o l_o m_o n_o}^{-6,+6} A_{i_o j_o k_o l_o m_o n_o} \cdot \\ & \cos(i_o \tau + j_o s + k_o h + l_o p + m_o N' + n_o p')] + \\ & G'_{i_o}(\varphi) \sum_{j_o k_o l_o m_o n_o}^{-6,+6} B_{i_o j_o k_o l_o m_o n_o} \cdot \\ & \sin(i_o \tau + j_o s + k_o h + l_o p + m_o N' + n_o p')] \end{aligned} \quad (2.24)$$

where τ is the number of mean lunar days from the adopted time origin, φ is the latitude of the observer, G_{i_o} and G'_{i_o} are the geodetic coefficients of Doodson, and the integers i_o , j_o , k_o , l_o , m_o and n_o the so-called Doodson numbers. Each term of the development (2.24) is called a constituent. It has amplitude A or B and is characterised by the combination of integers i_o , j_o , k_o , l_o , m_o and n_o , or equivalently by the frequency

$$f_j = \frac{1}{2\pi} (i_o \omega_1 + j_o \omega_2 + k_o \omega_3 + l_o \omega_4 + m_o \omega_5 + n_o \omega_6) \quad (2.25)$$

where ω_1 , ω_2 , ω_3 , ω_4 , ω_5 and ω_6 represent respectively the rates of change of τ , s , h , p , N' and p' per mean solar hour or per mean lunar day depending on the choice of the time variable. The periods and frequencies of these basic astronomical motions are presented in Table 2.2. The astronomical argument V_j (see Section 2.4) is defined by

$$V_j = i_o \tau + j_o s + k_o h + l_o p + m_o N' + n_o p' \quad (2.26)$$

Table 2.2 Basic periods and frequencies of astronomical motions

	Period	Frequency f	Angular Speed		
			σ	symbol in radiance	rate of change of
Mean Solar Day	1.00 mean solar days	1.00 cycles per mean solar day	15.000 degrees per mean solar hour	ω_0	C_s
Mean Lunar Day	1.0351	0.9661369	14.4921	ω_1	C_m
Sidereal Month	27.3217	0.366009	0.5490	ω_2	S
Tropical Year	365.2422 Julian Years	0.0027379	0.0411	ω_3	h
Moon's Perigee	8.85	0.00030937	0.0046	ω_4	p
Regression of Moon's Nodes	18.61	0.0001471	0.0022	ω_5	N'
Perihelion	20942	-	-	ω_6	p'

Doodson called a set of constituents with a common i_0 a species and a set of constituents within the same species with a common j_0 a group. By extension a set of constituents with a common $i_0 j_0 k_0$ is usually called a subgroup. It is of practical importance to mention that subgroups can be separated by analysis of 1-year records.

The values of the astronomical variables in the constituent data package used in the program were calculated by Foreman (1977) from power series expansion formulae presented in the Explanatory Supplement to the Astronomical Ephemeris and the American Ephemeris and Nautical Almanac (1961), and in the Astronomical Ephemeris (1974). The reference time origin t_r adopted is 000 ET³ 1 January 1976.

In the program, the astronomical variables at time t , which are used in the calculation of the astronomical argument V and of the model factors u and f (see Section 2.5), are obtained through a first order approximation; e.g. $s(t) = s(t_r) + (t-t_r) ds(t_r)/dt$. Provided they are consistent with other time dependent calculations, t and t_r can be chosen arbitrarily. It is then possible to write:

³ Ephemeris Time (ET), see Glossary

$$\begin{aligned}
 V(t) &= i_o \tau(t) + j_o s(t) + k_o h(t) + l_o p(t) + \\
 & m_o N'(t) + n_o p'(t) = \\
 & i_o \tau(t_r) + j_o s(t_r) + k_o h(t_r) + \\
 & l_o p(t_r) + m_o N'(t_r) + n_o p'(t_r) + \\
 & (t - t_r) \cdot \frac{\partial}{\partial t} [i_o \tau(t) + j_o s(t) \dots]_{t=t_r} = \\
 & V(t) + (t - t_r) 2\pi f
 \end{aligned}
 \tag{2.27}$$

for every frequency.

2.4 Astronomical Argument and Greenwich Phase Lag

On the basis of Doodson's harmonic development, tidal levels can then be represented by a finite number of harmonic terms of the form

$$\sum_{j=0}^N a_j \cos(V_j(t) - g_j)
 \tag{2.28}$$

where for the generic constituent j , a_j is the amplitude, V_j the astronomical argument and g_j the phase lag on the Equilibrium Tide.

If, for practical purposes, a local time origin t_o is considered, we can write using the previous development, see equation (2.27):

$$\sum_{j=0}^n a_j \cos(\omega_j t + V_j^o - g_j)
 \tag{2.29}$$

where

$$V_j^o = V_j(t_o) = V_j(t_r) + (t_o - t_r)\omega_j
 \tag{2.30}$$

In order to increase the efficiency of the computations, t_o is chosen to be the central hour of the record to be analysed.

The astronomical argument $V(L, t)$ of a tidal constituent can be viewed as the angular position of a fictitious star relative to longitude L at time t . This fictitious star is the causal agent of the constituent, and is assumed to travel around the equator with an angular speed equal to that of its corresponding constituent. Although the longitudinal dependence can be easily calculated, for historical reasons L is generally assumed to be the Greenwich meridian, and V is reduced to a function of one variable.

The Greenwich phase lag is then given by the sum of the astronomical argument for Greenwich and the phase φ_j of the observed constituent signal, as obtained from a sinusoidal regression analysis, such that

$$\sum_{j=0}^N a_j \cos(\omega_j t - \varphi_j) \tag{2.31}$$

φ_j being a function of the time origin adopted.

Comparing equations (2.29) and (2.31), it turns out that

$$g_j + \varphi_j + V_j^o \tag{2.32}$$

In this analysis it is implicit that all observations have been recorded or converted to the same time reference. To avoid possible misinterpretation of phases due to the use of conversions between different time zones, it is a recommended practice to convert all observations to GMT.

The practical importance of the Greenwich phase lag is that it is a constant, thus independent of the time origin. Physically it can be interpreted as the angular difference between the Equilibrium Tide and the observed tide as schematically shown in Figure 2.6.

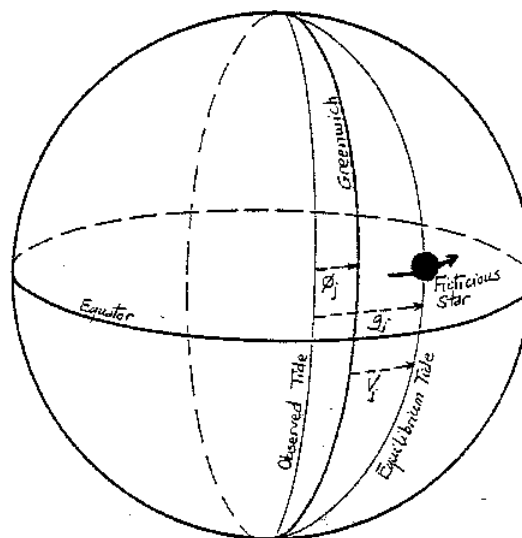

Figure 2.6 Relation between the Equilibrium tide and the Observed tide

If the tidal prediction is to be referred to a local meridian L , and given the fact that the astronomical argument V_j is calculated in relation to Greenwich, the following correction is necessary:

$$g_j^L = L + g_j \tag{2.33}$$

This can be easily verified noting that the position of the observed tide in relation to L is given by $V_j^L - g_j$, V_j^L being the astronomical argument referred to L . It then follows that:

$$V_j^L - g_j = V_j - L - g_j = V_j - (L + g_j) \quad (2.34)$$

2.5 Satellite Constituents and Nodal Modulation

Doodson's (1921) development of the tidal potential contains a very large number of constituents. The large record length necessary for their separation makes it practically impossible to analyse all the constituents simultaneously.

In general terms, for each of the main constituents included in a tidal analysis only an apparent amplitude and phase are obtained due to the effects of the non-analysable constituents, which depend on the duration of the period considered. Adjustments are then necessary so that the true amplitudes and phases of the specified constituents are obtained.

The standard approach to this problem is to form clusters consisting of all constituents with the same first three Doodson numbers. The major constituent (in terms of tidal potential amplitude) lends its name to the cluster and the lesser constituents are called satellites. The adjustments calculated in these conditions are exact for 1-year analysis, and are currently called nodal modulation. However, it is worth mentioning that this designation is actually not correct. It has been used before the advent of modern computers to designate corrections for the moon's nodal progression that were not incorporated into the calculations of the astronomical argument for the main constituent. Thus, although the term nodal modulation will be retained through this work because of its generalised use, the term 'satellite modulation' is more appropriate because the adjustments above discussed are due to the presence of satellite constituents differing not only in the contribution of the lunar node to their astronomical argument, but also in the lunar and solar perigee.

In order to make the "nodal modulation" correction to the amplitude and phase of a main constituent, it is necessary to know the relative amplitudes and phases of the satellites. It is commonly assumed that the relationships found for the Equilibrium Tide (tidal potential) also hold for the actual tide constituents that are close in frequency. That is, the tidal potential amplitude ratio of a satellite to its main constituent is assumed to be equal to the corresponding tidal heights' amplitude ratio, and the difference in tidal potential phase equals the difference in the observed tidal phase.

Due to the presence of satellites in a given cluster or subgroup, the signal at the frequency ω_j is the result of

$$a_j \sin(V_j - g_j) + \sum_k A_{jk} a_{jk} \sin(V_{jk} - g_{jk}) + \sum_{\ell} A_{j\ell} a_{j\ell} \cos(V_{j\ell} - g_{j\ell}) \quad (2.35)$$

for the diurnal and terdiurnal constituents, and

$$a_j \cos(V_j - g_j) + \sum_k A_{jk} a_{jk} \cos(V_{jk} - g_{jk}) + \sum_{\ell} A_{j\ell} a_{j\ell} \sin(V_{j\ell} - g_{j\ell}) \quad (2.36)$$

for the slow and semidiurnal constituents. Single j subscript refers to the major contributor while jk and $j\ell$ subscripts refer to satellites originating from tidal potential terms of the second and third order, respectively. A is the element of the interaction matrix, which represents the interaction between a main constituent and its satellites.

The above expressions can be written in a simplified form as

$$f_j(t) a_j \cos[V_j(t) + u_j(t) - g_j] \quad (2.37)$$

where the nodal correction factors for amplitude and phase f_j and u_j can be evaluated through the formulae (Foreman, 1977)

$$f_j(t) = \left[\left(1 + \sum_k A_{jk} r_{jk} \cos(\Delta_{jk} - \alpha_{jk}) \right)^2 + \left(\sum_k A_{jk} r_{jk} \sin(\Delta_{jk} - \alpha_{jk}) \right)^2 \right]^{1/2} \quad (2.38)$$

$$u_j(t) = \arctan \left[\frac{\sum_k A_{jk} r_{jk} \sin(\Delta_{jk} - \alpha_{jk})}{\sum_k A_{jk} r_{jk} \cos(\Delta_{jk} - \alpha_{jk})} \right] \quad (2.39)$$

where $\Delta_{jk} = V_{jk} - V_j$ and α_{jk} is 0 if a_{jk} and a_j have the same sign or $\frac{1}{2}$ otherwise.

For the analysis of $2N + 1$ consecutive observations, Δt time units apart, the terms of the interaction matrix A_{jk} are given by

$$A_{jk} = \sin \frac{[(2N + 1)\Delta t(\omega_{jk} - \omega_j)/2]}{(2N + 1)\sin[\Delta t(\omega_{jk} - \omega_j)/2]} \quad (2.40)$$

where ω_j and ω_{jk} are the frequencies of the main contributor and of its satellites. It can be shown that $A_{jk} \approx 1$. For practical purposes it is assumed in the present programs that $A_{jk} = 1$.

In the development of equation (2.37) is also assumed that $g_j = g_{jk} = g_{j\ell}$ and that $r_{jk} = |a_{jk}|/|a_j|$, and $r_{j\ell} = |a_{j\ell}|/|a_j|$ are given by the ratio of the tidal equilibrium amplitudes of the satellites to the amplitude of the major contributor. Using expressions (2.38) and (2.39), it is then possible to calculate f_j and u_j for any constituent at any time. The low frequency constituents have not been subject to nodal modulation due to the fact that low frequency noise can be as much as one order of magnitude greater than the satellite contributions for the analysed signal.

2.6 The Representation of Tidal Currents

The representation of tidal currents is traditionally done using rectangular co-ordinates and complex variables. In the present case the east/west and north/south directions are adopted as the x and y directions. Assuming that both constituents of the current are made of a periodic constituent and of a set of tidal constituents with frequencies ω_j , the overall signal can be represented by a complex variable $Z(t)$ which can be expressed as

$$Z(t) = X_o(t) + \sum_{j=1}^M X_j \cos(\omega_j t - \varphi_j) + i \left[Y_o(t) + \sum_{j=1}^M Y_j \cos(\omega_j t - \varphi_j) \right] \quad (2.41)$$

Foreman (1978) shows that the contribution of a generic constituent j to $Z(t)$, that we here call $Z_j(t)$, is given by

$$Z_j(t) = Z_j^+(t) + Z_j^-(t) = a_j^+ \exp(i\varepsilon_j^+ + i\omega_j t) + a_j^- \exp(i\varepsilon_j^- + i\omega_j t) \quad (2.42)$$

where

$$a_j^+ = \left[\left(\frac{CX_j + SY_j}{2} \right)^2 + \left(\frac{CY_j - SX_j}{2} \right)^2 \right]^{1/2} \quad (2.43)$$

$$a_j^- = \left[\left(\frac{CX_j + SY_j}{2} \right)^2 + \left(\frac{CY_j - SX_j}{2} \right)^2 \right]^{1/2} \quad (2.44)$$

$$\varepsilon_j^+ = \arctan \left[\frac{CY_j - SX_j}{CX_j + SY_j} \right] \quad (2.45)$$

$$\varepsilon_j^- = \arctan \left[\frac{CY_j + SX_j}{CX_j - SY_j} \right] \quad (2.46)$$

with

$$CX_j = X_j \cos \varphi_j \quad (2.47)$$

$$SX_j = X_j \sin \varphi_j \quad (2.48)$$

$$CY_j = Y_j \cos \varphi_j \quad (2.49)$$

$$SY_j = Y_j \sin \varphi_j \tag{2.50}$$

Examination of this expression reveals that two vectors are associated to each constituent j , $Z_j^+(t)$ and $Z_j^-(t)$, rotating with an angular speed of ω_j radians per hour.

$Z_j^+(t)$ has length a_j^+ , rotates counter-clockwise, and is at ε_j^+ radians counter-clockwise from the positive x axis at $t=0$ (Figure 2.7).

$Z_j^-(t)$ has length a_j^- , rotates clockwise and is at ε_j^- radians counter-clockwise from the positive x-axis at time $t = 0$.

The net rotational effect is that the composite vector $Z_j(t)$ rotates counter-clockwise if $a_j^+ > a_j^-$, clockwise if $a_j^+ < a_j^-$, and moves linearly if $a_j^+ = a_j^-$.

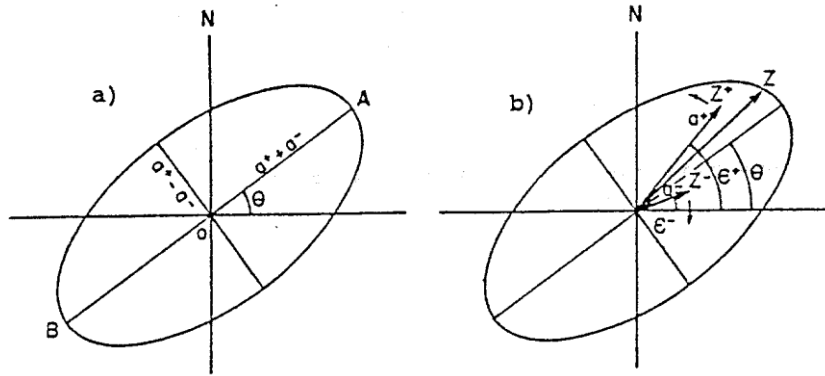

Figure 2.7 Current Ellipse Notation. a) Dimensions of a constituent ellipse; b) Configuration at $t=0$

Expression (2.42) can be further transformed into

$$Z_j(t) = \exp \left[i \left(\frac{\varepsilon_j^+ + \varepsilon_j^-}{2} \right) \right] \left[(a_j^+ + a_j^-) \cos \left(\left(\frac{\varepsilon_j^+ - \varepsilon_j^-}{2} \right) + \omega_j t \right) + i (a_j^+ + a_j^-) \sin \left(\left(\frac{\varepsilon_j^+ - \varepsilon_j^-}{2} \right) + \omega_j t \right) \right] \tag{2.51}$$

showing that over a time period of $2\pi/\omega$ hours, the path of the composite vector traces out an ellipse (which degenerates in a line segment when $a_j^+ = a_j^-$), whose respective major and minor semi axis lengths are $a_j^+ + a_j^-$ and $a_j^+ - a_j^-$, and whose angle of inclination from the positive x-axis is $(\varepsilon_j^+ + \varepsilon_j^-)/2$ radians.

As an aid to understand the development and meaning of Greenwich phases for tidal currents, it is convenient to extend the concept of fictitious stars previously used in tidal

elevation theory. Similarly, it is assumed that each pair of rotating vectors Z^+ and Z^- , is attributable to two fictitious stars which move counter-clockwise and clockwise respectively, at the same speed as the associated constituent, around the periphery of a 'celestial disk' tangential to the earth at the measurement site. It is also considered that at time t_0 , the angular position of the counter-clockwise rotating star, S^+ , the star responsible for Z^+ , is $V(t_0)$ radians counter-clockwise from the positive x axis, where $V(t_0)$ is the same astronomical argument, relative to Greenwich, as the one of the constituent in the tidal potential. Simultaneously, the angular position of the clockwise rotating star, S^- , is assumed to be at $V(t_0)$ radians clockwise from the positive x-axis. As a consequence, the constant phase angles g^+ and g^- by which S^+ and S^- lead (or lag) the respective vectors Z^+ and Z^- , Figure 2.8(a), can be termed Greenwich phases and are defined by

$$g^+ = V(t_0) - \epsilon^+ \tag{2.52}$$

$$g^- = V(t_0) - \epsilon^- \tag{2.53}$$

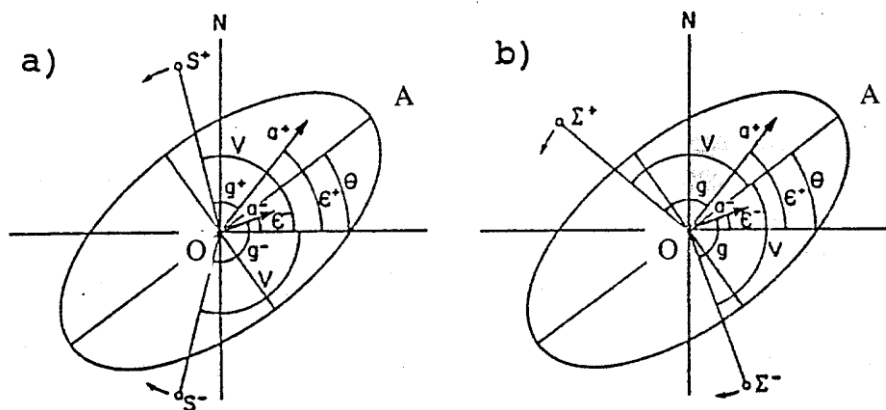

Figure 2.8 Definition of Greenwich Phase Lags
 a) Fictitious stars related to E-W axis
 b) Fictitious stars related to major semi-axis

Provided that the complex variable condition is satisfied- (the positive imaginary axis has to be 90° counter-clockwise from the positive real x-axis), the choice of a rectangular coordinate system for the original current measurements is arbitrary. Since all angles so far have been specified with respect to the east/west axis, there is a corresponding arbitrariness in the phases of Z_j^+ and Z_j^- . However, it is possible to obtain invariant phases for these vectors by referring angular measurements to a major semi-axis of the constituent ellipse, see Figure 2.8 (b). Two different fictitious stars, Z^+ and Z^- , similar to S^+ and S^- , can now be visualised, their angular positions at $t=0$ being now $V(t_0)$ radians from OA in the appropriate directions.

This approach has the advantage that the phase of both rotating vectors relative to their respective stars, can now be expressed as a single Greenwich phase angle g , given by

$$g = V(t_0) - \left[\frac{\epsilon^+ - \epsilon^-}{2} \right] \tag{2.54}$$

or

$$g = \left[\frac{g^+ + g^-}{2} \right] \quad (2.55)$$

In a similar way to the interpretation previously given for the Greenwich phase lag, g can now be viewed as the interval by which the instant of maximum current (when Z_j^+ and Z_j^- coincide along OA) lags the simultaneous transit of the fictitious stars Σ^+ and Σ^- , at OA .

It can also be proved that the maximum current occurs at times

$$t = \frac{g - V(t_o) + 2\pi n}{\omega}, \quad n = \dots, -1, 0, 1, \dots \quad (2.56)$$

The ambiguity due to the division by 2 in expression (2.54) is avoided in the program by imposing the condition that the northern major semi-axis of the constituent always be used as the reference axis (Foreman, 1977).

3 Some Criteria of Application

3.1 General

The analysis of a time series is based on the fact that any continuous and periodic function, such as

$$x(t) = x(t \pm jT) \quad j = 0, 1, 2, \dots \quad (3.1)$$

where T is the period, can be represented by a trigonometric Fourier series, given by

$$x(t) = \frac{X_0}{2} + \sum_{j=1}^{\infty} [X_j \cos(\omega_j t) + Y_j \sin(\omega_j t)] \quad (3.2)$$

which can be written in a more convenient way as

$$x(t) = A_0 + \sum_{j=1}^{\infty} A_j \cos(\omega_j t - \varphi_j) \quad (3.3)$$

where

$A_0 = X_0 / 2$ is the average of the time series

$A_j = \sqrt{X_j^2 + Y_j^2}$ is the amplitude of harmonic j

$\varphi_j = \arctan(Y_j / X_j)$ is the phase of harmonic j

and

$\omega_j = \frac{2\pi}{T} j$ is the angular frequency of harmonic j .

However, as explained in Section 2.4, in tidal analysis it is convenient to refer the phase of each constituent to the position of a fictitious star travelling around the equator with the angular speed of the corresponding constituent, the time series being then represented by the formula

$$x(t) = a_0 + \sum_{j=1}^{\infty} a_j \cos(\omega_j t + V_j^0 - g_j) \quad (3.4)$$

where a_j , V_j^0 and g_j are the amplitude, the astronomical argument at the adopted time origin $t=0$ and the Greenwich phase lag of the constituent with frequency ω_j , respectively.

From the development of Doodson's tidal potential it is known that the tidal constituents tend to gather in groups with very close frequencies, usually with a dominant component that contains most of the energy of the group. Due to the great number of constituents in

each group it is not practical for the modulation of a tidal signal to include explicitly all the constituents with very small amplitudes. Therefore a main constituent is selected, and the effects of its satellites are incorporated as corrections to the amplitude and phase of the main constituents. The modulation of a tidal signal can then be represented by

$$x(t) = a_0 + \sum_{j=1}^{\infty} f_j(t) a_j \cos(\omega_j t + V_j^0 + u_j(t) - g_j) \quad (3.5)$$

where the correction factors $f_j(t)$ and $u_j(t)$ represent the effects of the satellites on the amplitude and phase of each main constituent j . In other words each group of constituents is modelled by a sinusoidal function with a time varying amplitude and phase, given by

$$A_j(t) = f_j(t) a_j \quad (3.6)$$

$$\varphi_j(t) = g_j - V_j^0 - u_j(t) \quad (3.7)$$

The values of V_j^0 , $f_j(t)$ and $u_j(t)$ are universal for any tidal constituent j , and are therefore independent of the time series to be analysed. Taking these considerations into account, the general methodology used for the analysis of tidal time series can be summarised as follows:

- a. Selection of the main constituents to be included in the analysis. The Rayleigh criterion is usually used and will be presented in detail in next Section.
- b. Calculation of the fictitious amplitudes and phases A_j and φ_j , through the application of sinusoidal regression techniques for the solution of the system of equations (3.3).
- c. Inference of main group constituents which are not analysable over the duration of the available time series. The basis for inference will be presented in Section 3.3.
- d. Calculation of the astronomical argument of each component V_j^0 at the time origin adopted, as well as of the correction factors f_j and u_j . The universal formulae used have been presented in Section 2.5.
- e. Calculation of the amplitudes and Greenwich phase lags of the main constituents analysed or inferred, through the application of relations (3.6) and (3.7), is

$$a_j = \frac{A_j}{f_j(t_c)} \quad (3.8)$$

where t_c is taken as the central hour of the total period analysed.

The accuracy obtained in the modulation of tidal time series using the above methodology is obviously dependent on the length of the time series available. The following aspects should be taken into consideration:

- a. The theory of nodal or satellite modulation is based, in the present program, on the constituents that have the same first three Doodson numbers. The main constituents of each group are only analysable for time series with at least the duration of 1 year. For time series with shorter durations, not all the main constituents can be analysed, which means that the calculated values A_j and φ_j obtained by sinusoidal regression for the specified main constituents, include not only the effect of the satellites in each group but also the effects of the non-analysed main constituents.

Therefore additional correction factors would be needed to obtain the correct modulation of the analysed main constituents. However, in practice it is not possible to calculate these additional factors, due to the following reasons:

- The tidal potential ratios found for the equilibrium tide cannot be assumed to be representative of the amplitude ratios of constituents that belong to different groups. The assumption is that local effects are only equivalent for constituents with very close frequencies.
- The spreading of energy of a non-analysed constituent by the neighbouring analysed main constituents depends on the set of constituents selected for analysis.

The errors introduced by using nodal modulation factors for the analysis of periods other than one year obviously depend on the duration of the time series. In particular, they increase with the decrease of the duration of the time series. Depending on the distribution of the energy by frequencies, some components will be more accurate than others, and it is not possible to establish general rules for the evaluation of the errors.

It should be kept in mind that, with the assumptions of the present tidal analysis programs, it is only possible to make accurate forecasts on the basis of the analysis of time series covering periods of 1 year or longer.

- b. The speed of propagation of a progressive long wave is approximately proportional to the square root of the depth of water in which it is travelling. Thus, shallow water has the effect of retarding the trough of a wave more than the crest, which distorts the original sinusoidal wave shape and introduces harmonic signals that are not predicted in the tidal potential development. The frequencies of these harmonics can be found by calculating the effect of non-linear terms in the hydrodynamic momentum equations (Godin, 1972).

When shallow water effects are important and the frequencies of main and non-linear origin constituents are such that they cannot be separated over the available time series, the analysed values of the amplitude and phase of the main constituent will be affected by the presence of the shallow water constituent. Therefore, the calculated nodal modulation of the main constituent will not be representative of the global effects of the non-resolved constituents (shallow water constituents and satellites). A series of successive analysis can be done to check the effectiveness of the nodal corrections and the presence of shallow water constituents.

- c. The formulation of the tidal analysis programs does not account for non-tidal generated constituents, as for example seiches and meteorological waves. It is convenient that the time series to be analysed by the present programs have been previously filtered from non-tidal effects, when they are expected to strongly interact with the main constituents to be analysed. If necessary, the analysis of non-tidal effects can be obtained through a Fourier analysis of the corresponding filtered time

series, or through the direct specification of specific non-tidal frequencies to be used together with the tidal constituents in a sinusoidal regression analysis. This procedure is especially interesting for the treatment of relatively short periods (e.g. 15 days) that, from an engineering point of view, are representative of the main phenomena of interest, having also the practical advantage of providing simultaneously with the calculation of the tidal constituents, the separation of tidal and non-tidal effects.

One of the practical interests of the present programs for engineering applications is the short term forecast for stations located in a certain study zone, in order to provide a compatible set of data for the calibration and verification of mathematical models. In fact, due to limitations of time and resources, it is usually not possible to deploy simultaneously the necessary instruments for measuring time series of levels and currents. Even for those instruments operating simultaneously, important gaps may occur, which can also be filled through the application of the tidal analysis programs. In these applications the previous remarks concerning the accuracy of the calculated amplitudes and phases should be kept in mind. In the ideal situation of having simultaneous time series of the same duration for all the points selected for a study, no forecast is necessary, and the fictitious values obtained directly from the sinusoidal regression analysis are enough for most of the needs of coastal engineering applications. In particular they represent correctly the overall effects of the interaction between all the main and satellite constituents for the period analysed, which means that this period can be simulated with very good accuracy.

3.2 Selection of Constituents

Given two sinusoidal waves of frequencies ω_i and ω_j , their interaction originates a composed wave with a frequency given by the average of the frequencies of the parent sinusoidal waves and with a variable amplitude. As shown in Section 2.1 the amplitude variation has a frequency equal to the difference between the frequencies of the original waves. As a consequence the resulting phenomenon has a period of repetition, the synodic period, given by

$$T_s = \frac{2\pi}{\omega_i - \omega_j} \quad (3.9)$$

The synodic period T_s of two sinusoidal waves represents then the minimum duration necessary for their separation, that is, given a time series of duration T_r , the following condition must be fulfilled

$$T_r > T_s \quad (3.10)$$

Taken a tidal constituent as the comparison constituent, Rayleigh used the above conditions to decide if whether or not a specific constituent should be included in the analysis of a certain time series. If ω_0 is the frequency of the comparison constituent, a constituent of frequency ω_1 will be included in the analysis if

$$\frac{|\omega_0 - \omega_1|}{2\pi} T_r \geq RAY \quad (3.11)$$

where RAY is user defined, and commonly known as the Rayleigh number. $RAY = 1$ corresponds of using the minimum period necessary for the separation of the two constituents, i.e. the synodic period.

In order to determine the Rayleigh comparison pairs, it is important to consider, within a given constituent group (e.g. diurnal or semi-diurnal), the order of constituent inclusion in the analysis as T_r (the duration of the record to be analysed) increases. In this context the following criteria for the selection of constituents for a tidal analysis have been used in the present program.

- d. within each constituent group, when possible, the constituent selection is made according to the order of the decreasing magnitude of the tidal potential amplitude (as calculated by Cartwright, 1973);
- e. when possible, the candidate constituent is compared with whichever of the neighbouring, already selected constituents, that are nearest in frequency;
- f. when there are two neighbouring constituents with comparable tidal potential amplitudes, rather than waiting until the record length is sufficient to permit the selection of both at the same time (i.e. by comparing them to each other), a representative of the pair to which corresponds the earliest inclusion, is adopted. This will give information sooner about that frequency range, and via inference, will still enable some information to be obtained on both constituents.

Taking into account the above criteria, the Rayleigh comparison pairs chosen for the low frequency, diurnal, semi-diurnal and terdiurnal constituent groups are given in Table 3.1 to Table 3.4, respectively. Figures given for the length of record required for constituent inclusion assume a Rayleigh number 1.0.

Table 3.1 Order of selection of long-period constituents in accordance with the Rayleigh criterion

← Link Rayleigh Comparison Pairs
() Tidal Potential Amplitudes for Main Constituents

Length of Record (hr) Required for Constituent Inclusion	Frequency Differences (cycles/hr) × 10 ³ Between Neighbouring Constituents						
	ZO	SA	SSA	MSM	MM	MSF	MF
13	0.11407	0.11408	1.08162	0.20237	1.30978	0.22816	
355	ZO					(1369) MSF	
764					(8254) MM		
4383			(7281) SSA				(15647) MF
4942				(1579) MSM			
8766		(1156) SA					

Table 3.2 Order of selection of diurnal constituents in accordance with the Rayleigh criterion

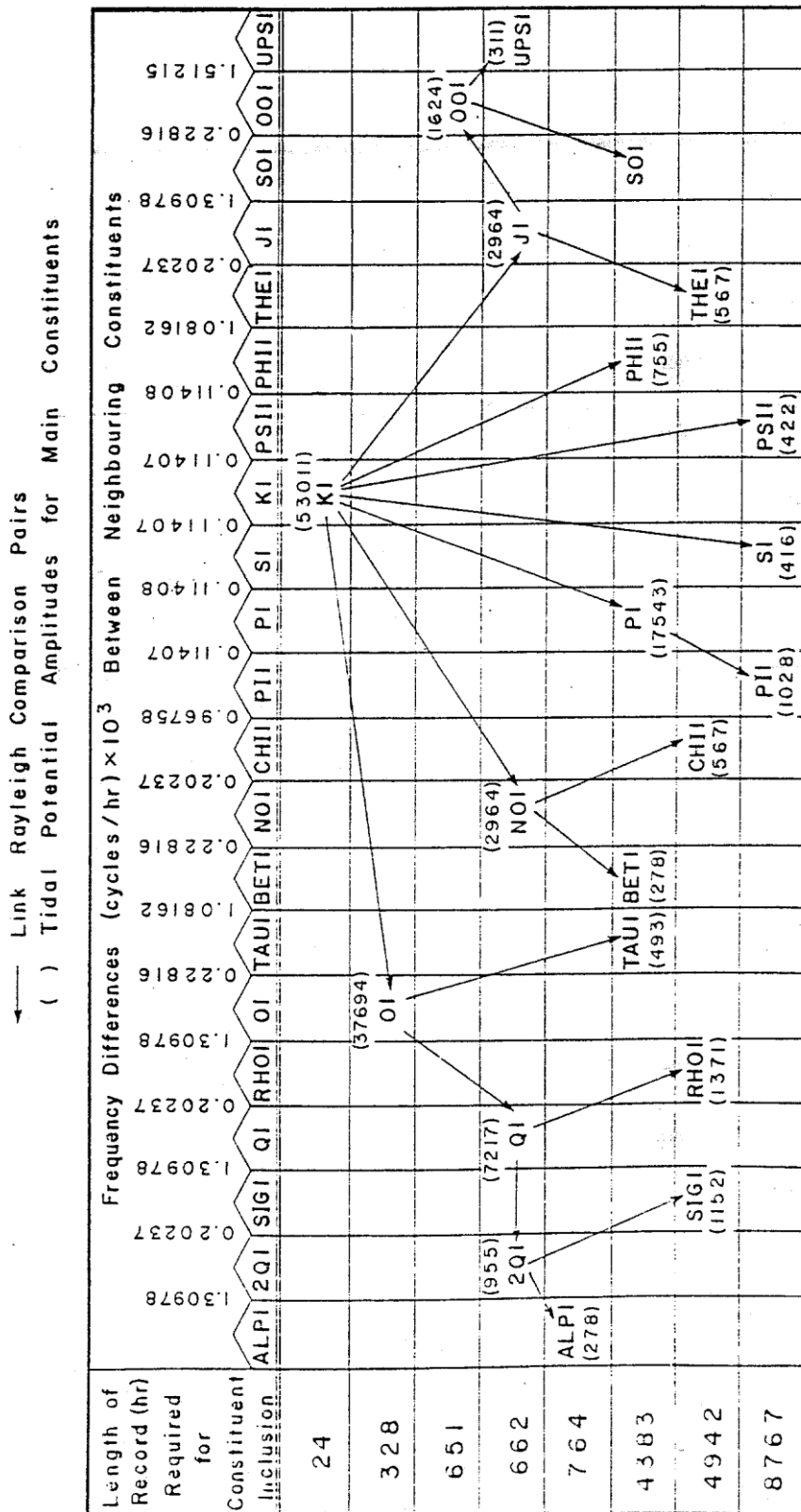

Table 3.3 Order of selection of semi diurnal constituents in accordance with the Rayleigh criterion

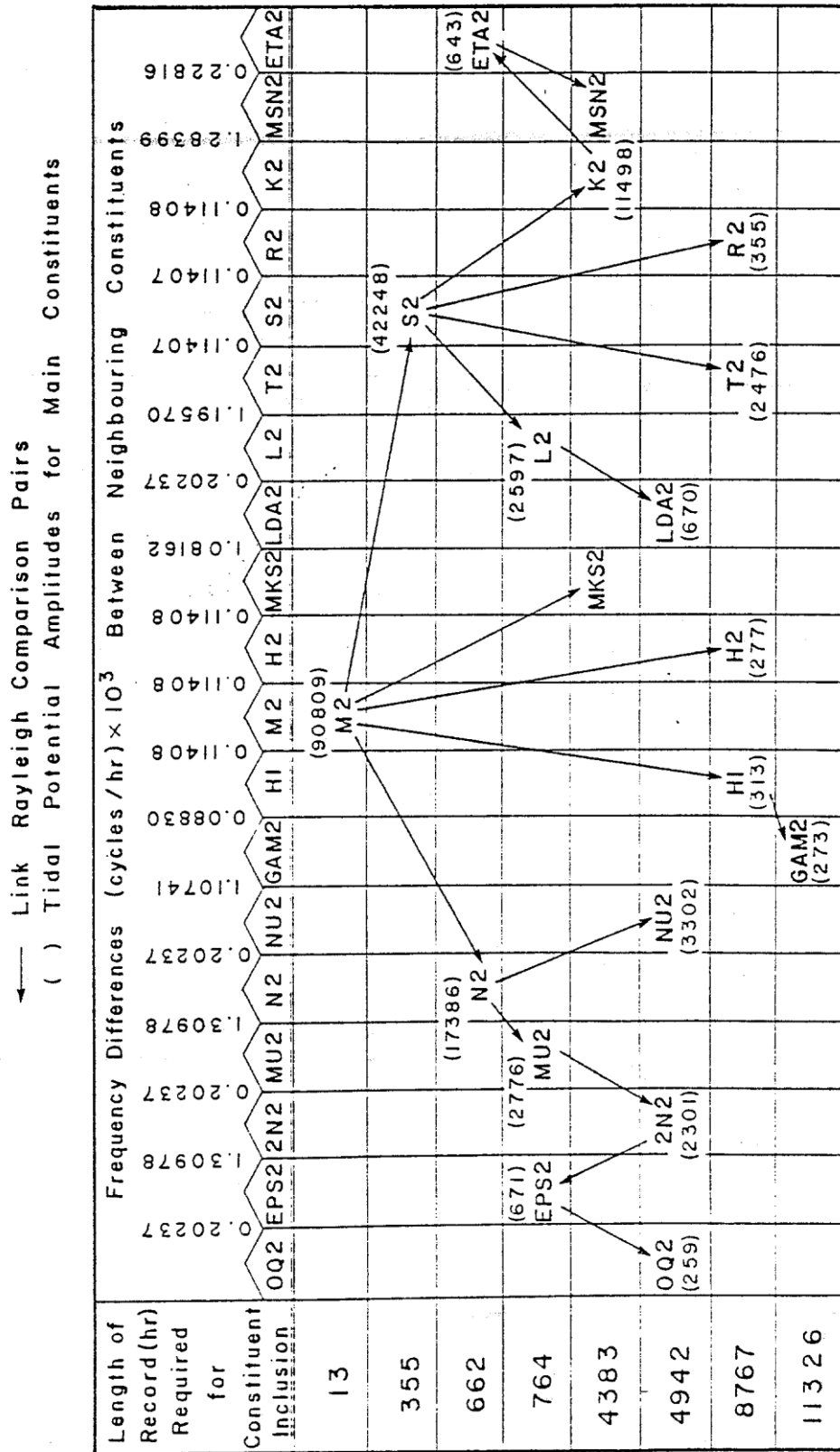
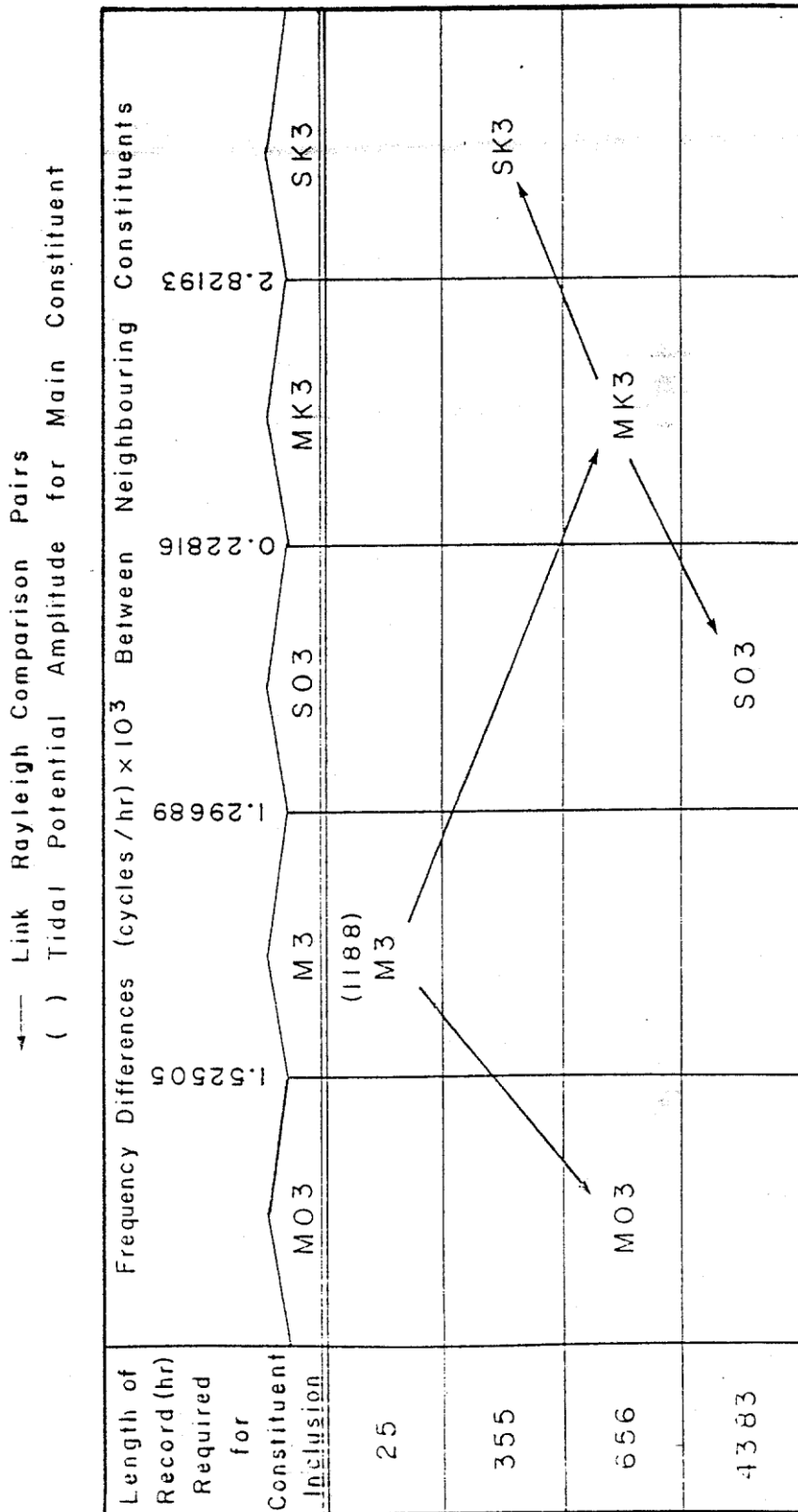

Table 3.4 Order of selection of terdiurnal constituents in accordance with the Rayleigh criterion



As previously mentioned, shallow water constituents do not have a tidal potential amplitude and consequently, objective i) does not apply to them. However, a hierarchy of

their relative importance has been used for their selection according to Godin. A further criteria used by Foreman is that no shallow water constituent should appear in an analysis before all the main constituents from which it is derived, have also been selected. Table 3.5 shows that this has been upheld for all the shallow constituents included in the standard 69 constituent data package used in the present programs. The criteria outlined here should be followed when choosing the Rayleigh comparison constituent for any of the additional constituents included in the constituent data package.

Table 3.5 Shallow water constituents included in the standard data package

Shallow Water Constituent	Length of Record (hr) Required for Constituent Inclusion	Component Main Constituents and Lengths (hr) of Record Required for Their Inclusion in the Analysis					
		S 2	3 5 5	O 1	3 2 8	S 2	3 5 6
S O 1	4 3 8 3	S 2	3 5 5	O 1	3 2 8		
M K S 2	4 3 8 3	M 2	1 3	K 2	4 3 8 3	S 2	3 5 6
M S N 2	4 3 8 3	M 2	1 3	S 2	3 5 5	N 2	6 6 2
M O 3	6 5 6	M 2	1 3	O 1	3 2 8		
S O 3	4 3 8 3	S 2	3 5 5	O 1	3 2 8		
M K 3	6 5 6	M 2	1 3	K 1	2 4		
S K 3	3 5 5	S 2	3 5 5	K 1	2 4		
M N 4	6 6 2	M 2	1 3	N 2	6 6 2		
M 4	2 5	M 2	1 3				
S N 4	7 6 4	S 2	3 5 5	N 2	6 6 2		
M S 4	3 5 5	M 2	1 3	S 2	3 5 5		
M K 4	4 3 8 3	M 2	1 3	K 2	4 3 8 3		
S 4	3 5 5	S 2	3 5 5				
S K 4	4 3 8 3	S 2	3 5 5	K 2	4 3 8 3		
2 M K 5	2 4	M 2	1 3	K 1	2 4		
2 S K 5	1 7 8	S 2	3 5 5	K 1	2 4		
2 M N 6	6 6 2	M 2	1 3	N 2	6 6 2		
M 6	2 6	M 2	1 3				
2 M S 6	3 5 5	M 2	1 3	S 2	3 5 5		
2 M K 6	4 3 8 3	M 2	1 3	K 2	4 3 8 3		
2 S M 6	3 5 5	S 2	3 5 5	M 2	1 3		
M S K 6	4 3 8 3	M 2	1 3	S 2	3 5 5	K 2	4 3 8 3
3 M K 7	2 4	M 2	1 3	K 1	2 4		
M 8	2 6	M 2	1 3				

3.3 Inference

If the length of a tidal record is such that certain important constituents cannot be included directly in the analysis, approximate relationships can be used for the inference of their amplitudes and phases. However, these formulae are an 'a posteriori' correction to the values obtained by sinusoidal regression and only affect the component from which the inference is made. Noting that the non-inclusion of an important constituent affects all the surrounding constituents, the accuracy of an inferred constituent will be greatly dependent on the relative magnitude and frequencies of the neighbouring constituents. The errors associated with the spreading of energy of the missing constituents by the neighbouring constituents due to the sinusoidal regression analysis cannot be compensated for.

Given a constituent with frequency ω_2 to be inferred from a constituent with frequency ω_1 , and denoting the fictitious amplitude and phase calculated for the latter by A_1' and ϕ_1' , the corrected and inferred values for both constituents can be found through the formulae:

$$A_1 = A_1' / \sqrt{C^2 + S^2} \quad (3.12)$$

$$\phi_1 = \phi_1' + [\arctan(S / C)] / 2\pi \quad (3.13)$$

$$a_1 = r_{12} A_1 (f_2 / f_1) \quad (3.14)$$

$$\phi_2 = (V_1 + u_1) - (V_2 + u_2) + \phi_1 - \tau \quad (3.15)$$

where

$$r_{12} = \frac{a_2}{a_1} = (A_2 / f_2) / (A_1 / f_1) \quad (3.16)$$

$$\tau = g_1 - g_2 \quad (3.17)$$

$$S = r_{12} \left(\frac{f_2}{f_1} \right) \sin \left[\frac{T_r}{2} (\omega_2 - \omega_1) \right]. \quad (3.18)$$

$$\sin [(V_2 + u_2) - (V_1 + u_1) + \tau] / \frac{T_r}{2} (\omega_2 - \omega_1)$$

$$C = 1 + r_{12} \left(\frac{f_2}{f_1} \right) \sin \left[\frac{T_r}{2} (\omega_2 - \omega_1) \right]. \quad (3.19)$$

$$\cos [(V_2 + u_2) - (V_1 + u_1) + \tau] / \frac{T_r}{2} (\omega_2 - \omega_1)$$

In the program the amplitude ratio r_{12} and the Greenwich phase lag differences are user specified.

4 Program Description

4.1 IOS Method

4.1.1 General introduction

In the traditional harmonic method for the description of tide, such as the one implemented in the IOS method (by G Foreman), the tidal variation is described by harmonic constituents, except for the nineteen yearly variation of the tide caused by periodic changes in the lunar orbital tilt.

Variations caused by the nineteen yearly variation in the lunar orbital tilt is described by amplitude and phase corrections to tidal constituents (denoted nodal corrections). Doodson tidal constituents describe sub- and super-harmonics as well as seasonal variations.

This method is potentially the most detailed description of the tide at a specific location, and is therefore typically used for locations where the tide is monitored continuously through several years.

The Rayleigh criterion is used for the selection of constituents from a standard data package composed by 69 constituents. The standard constituents include 45 astronomical main constituents and 24 shallow water constituents. They are derived only from the largest main constituents, M_2 , S_2 , N_2 , K_2 , K_1 and O_1 , using the lowest types of possible interaction.

Additionally, 77 shallow water constituents can be included if explicitly requested by the user. The shallow water constituents that can be included in the modulation of tidal time series, are derived from the remainder main constituents considering higher types of interaction.

The amplitudes and phases are calculated via a least squares method, which enables the treatment of records with gaps. For the calculation of frequencies, nodal factors and astronomical arguments, the program is based on Doodson's tidal potential development and uses the reference time origin of January 1, 1976 for the computation of astronomical variables.

4.1.2 Time series representation

The general representation of a tidal time series is made according to the harmonic development

$$x(t) = \sum_{j=1}^N f_j(t) a_j \cos(V_j(t) + u_j(t) - g_j) \quad (4.1)$$

where

a_j , g_j are the amplitude and Greenwich phase lag, $f_j(t)$, $u_j(t)$ are the nodal modulation amplitude and phase correction factors, and $V_j(t)$ is the astronomical argument, for constituent j .

The astronomical argument $V_j(t)$ is calculated as

$$V_j(t) = V_j(t_0) + (t - t_0)\omega_j \quad (4.2)$$

where t_0 is the reference time origin.

The first stage in the analysis of tidal records is done via a least squares fit method for the computation of the amplitudes A_j and phases f_j representative of the combined effects of the main constituents and respective satellites, according to

$$x(t) = \sum_{j=1}^N A_j \cos(\omega_j t - \varphi_j) \quad (4.3)$$

The time series to be analysed have to be recorded with a 1-hour interval, and gaps can be handled automatically by the program. In order to reduce the computational time, the time origin is taken as the central hour of the record.

For the purpose of forecasting, the values of the amplitudes and Greenwich phase lags of the main constituents, as well as the corresponding time dependent correction factors that account for satellite interaction, are calculated via nodal modulation.

The following relationships are used:

$$a_j = A_j / f_j(t_0) \quad (4.4)$$

$$g_j = V_j(t_0) + u_j(t_0) + \varphi_j \quad (4.5)$$

where t_0 is the central hour of the tidal record.

The program calculates the correction factors for all satellites that have the same first three Doodson numbers, which implies that the modulation is only fully effective for records with one year of duration.

4.1.3 Rayleigh criterion

The Rayleigh criterion is applied for the choice of main constituents, the synodic period being considered as default (Rayleigh number equal to 1.0). For records shorter than 1 year, some main constituents cannot be analysed, which implies the falsification of the amplitudes and phases of the neighbouring constituents. It should be kept in mind that the programs cannot compensate for the associated errors, because the nodal modulation supposes that all the main constituents have been included in the analysis. Nevertheless a correction can be made for the nearest component in frequency, with simultaneous inference of the amplitude and phase of the non-analysed constituent, when requested by the user.

When applying equation (4.1) for prediction, the nodal correction factors $f(t)$ and $u(t)$ are approximated by a constant value throughout the period of a month, calculated at 00 hr of the 16th day of the month. This approximation is currently used due to the small variations experienced by those factors over the period of a month. It should be kept in mind that differences between analysed and predicted records may arise due to the fact that for analysis the nodal correction factor are calculated only for the central hour of the whole

record. In any case the calculation of f , u and V is based on the values of the astronomical variables s , h , p , N' and p' at the reference time January 1, 1976, and on the first term in their Taylor expansion, e.g.

$$s(t) = s(t_r) + (t - t_r) \frac{\partial s(t_r)}{\partial t} \quad (4.6)$$

4.1.4 Step-by-step calculation

The steps performed by the analysis programs are as follows:

1. Data input comprising:
 - control and decision parameters
 - time series (levels or north/south and east/west current components)
2. Calculation of the middle hour t_c of the analysis period.
3. Calculation at t_c , of the nodal modulation correction factors f and u and of the astronomical arguments V , for all the constituents in the constituent data package.
4. Determination via the Rayleigh criterion, of the constituents to be used in the least squares fits.
5. Construction and solution relative to time t_c , of the least squares matrices (for levels or for each of the x (east/west) and y (north/south) current components). Details of the fit, such as error estimates, average, standard deviation, matrix condition number and root mean square residual error values are given, together with the parameters C_j and S_j from which the amplitudes and phases of the constituents can be computed, according to the relationships given in equations (4.7) and (4.8).
6. Inference for the requested constituents not included in the least squares fit, and adjustment of the constituents used for inference.
7. Nodal modulations of the analysed and inferred constituents, using the previously computed nodal correction factors f and u . Greenwich phase lags and constituent amplitudes are then obtained (for currents the amplitudes of the major and minor semi-axis lengths).
8. Data output.

$$A_j = \sqrt{C_j^2 + S_j^2} \quad (4.7)$$

$$\varphi_j = \arctan(S_j / C_j) \quad (4.8)$$

5 Analyses of Tidal Height

5.1 Analysis of Tidal Height using the Admiralty Method

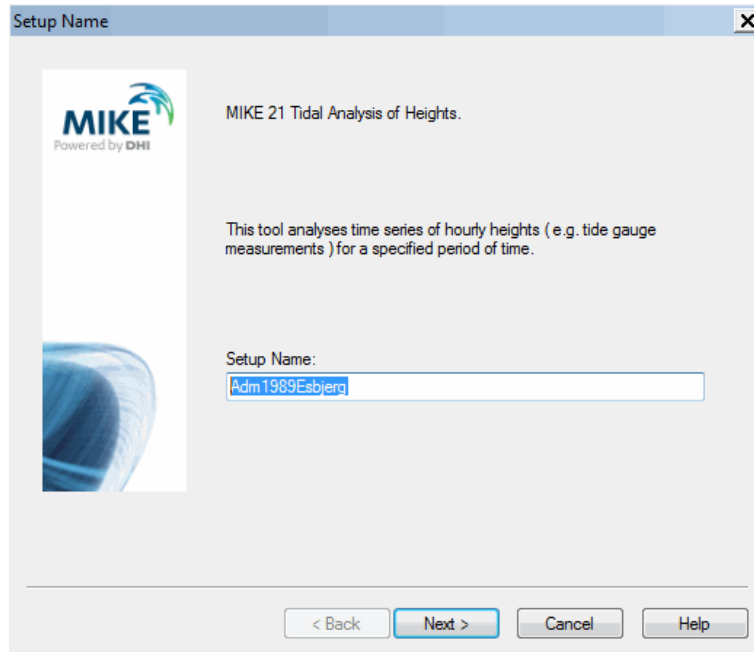

Figure 5.1 Specify a Name in the Tidal Analysis of Height from the Tidal Tools in MIKE 21 Toolbox

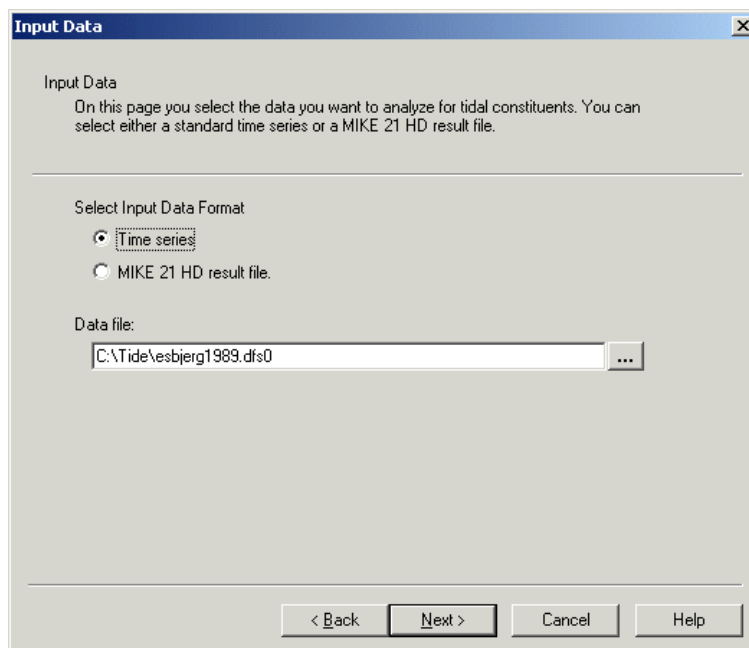

Figure 5.2 Specify Data Format of Time series to be analysed

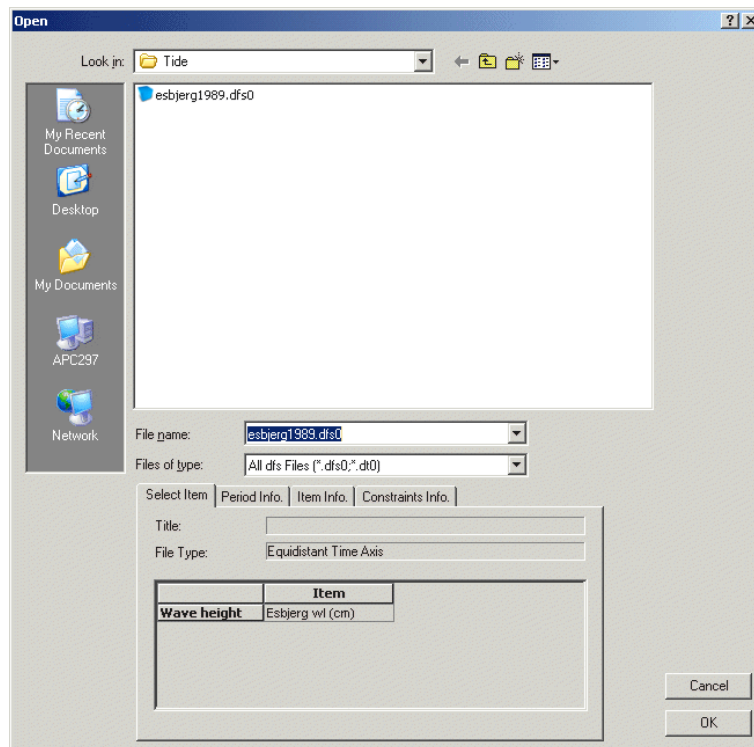

Figure 5.3 Select the time series to be analysed

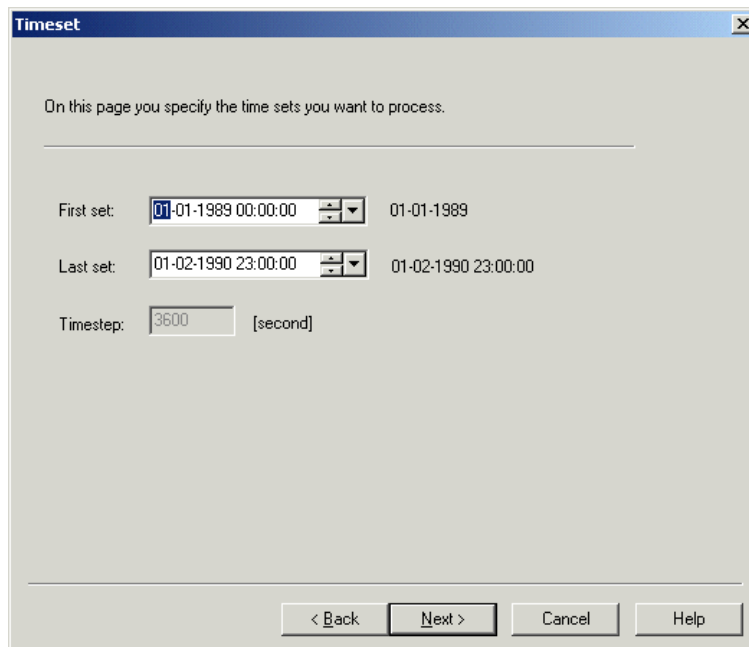

Figure 5.4 Specify the period to be analysed

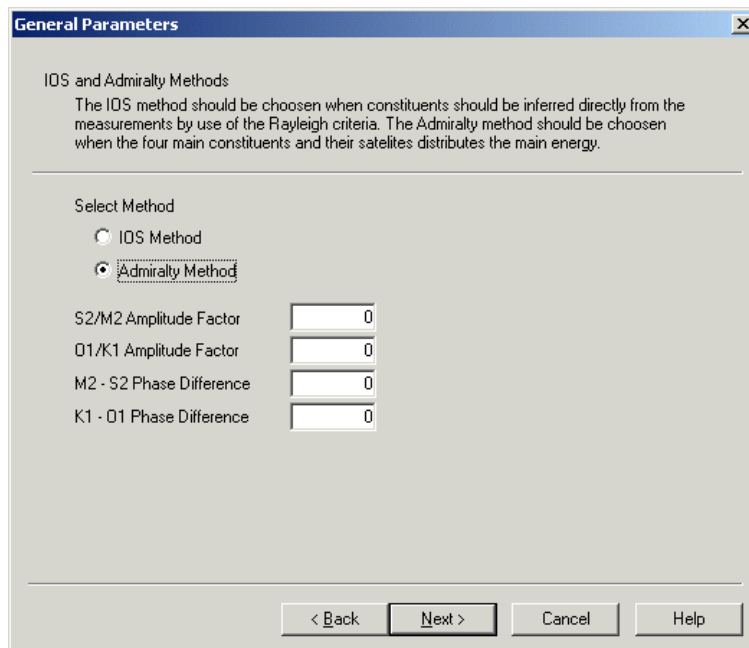

Figure 5.5 Select the Analysis Method. For short-range time series optional specify the Phase difference and Amplitude factor between M2-S2 and K1-O1

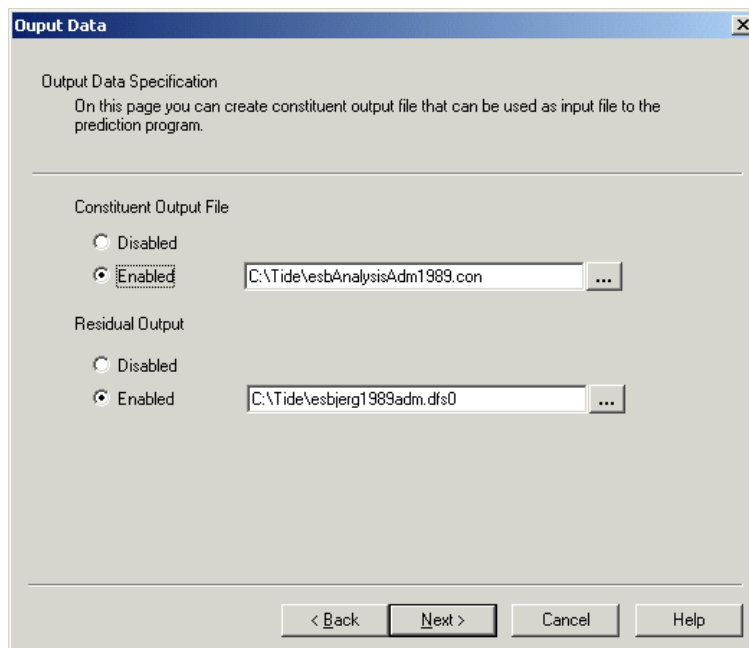

Figure 5.6 If enabled, specify the name of Constituent output file and Residual output file (see output examples)

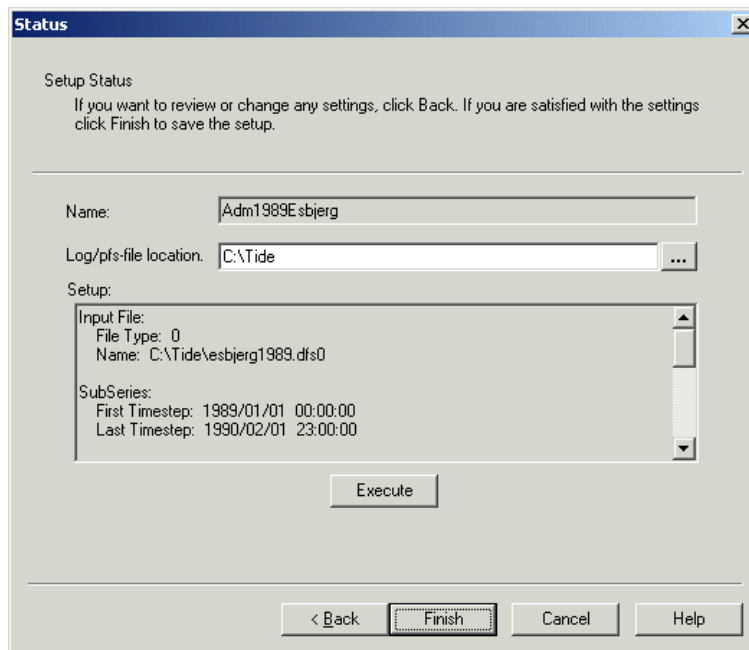

Figure 5.7 Specify location of log file and execute the program

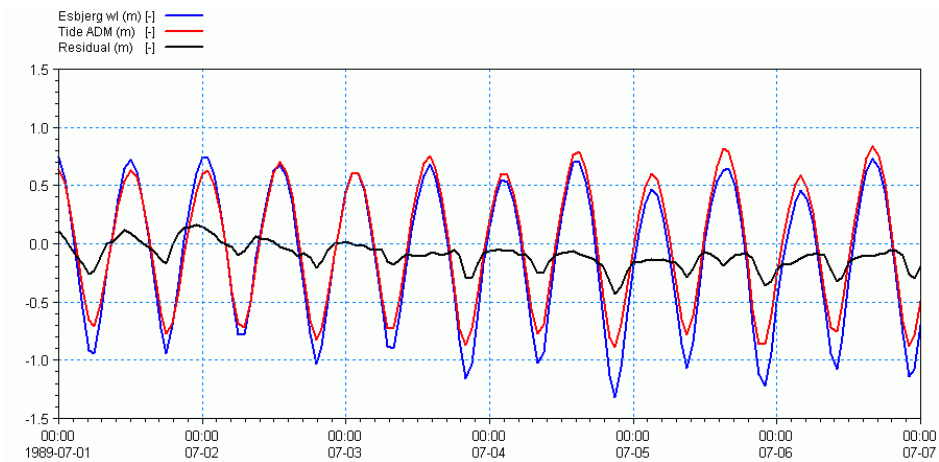

Figure 5.8 Example of Residual output file. The file includes the measured values, the calculated tide and the residual (the difference between the calculated and the measured tide)

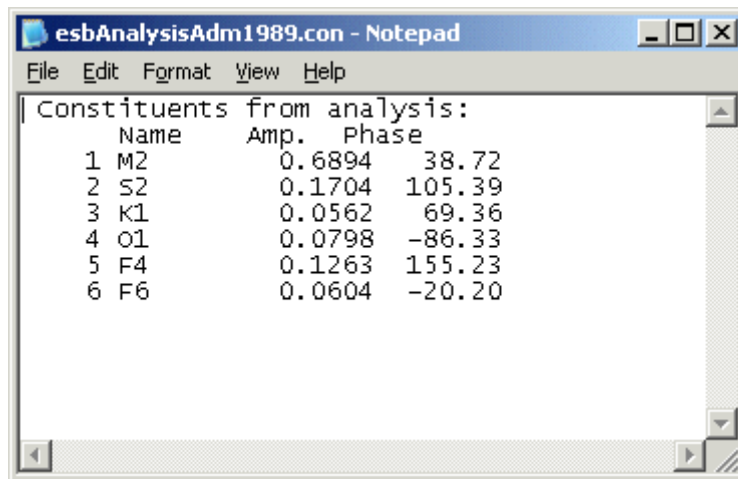

Figure 5.9 As an optional output, you can get the actual calculated constituent - an example is given above

5.2 Analysis of Tidal Height using the IOS Method

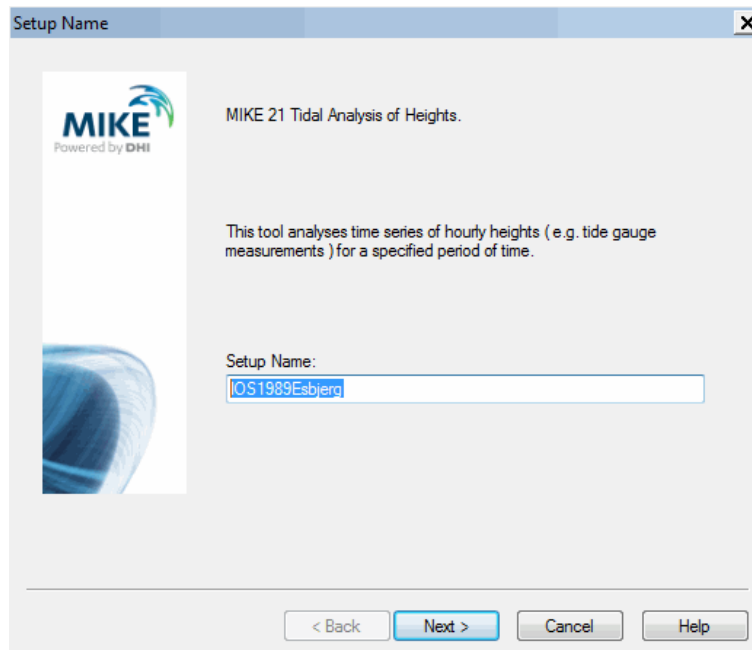

Figure 5.10 Specify a Name in the Tidal Analysis of Height from the Tidal Tools in MIKE 21 Toolbox

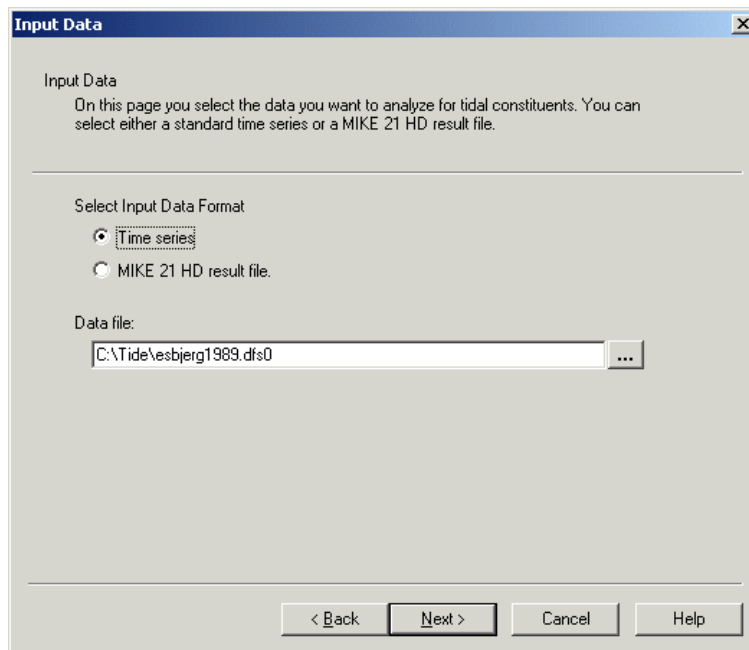

Figure 5.11 Specify Data Format of Time series to be analysed

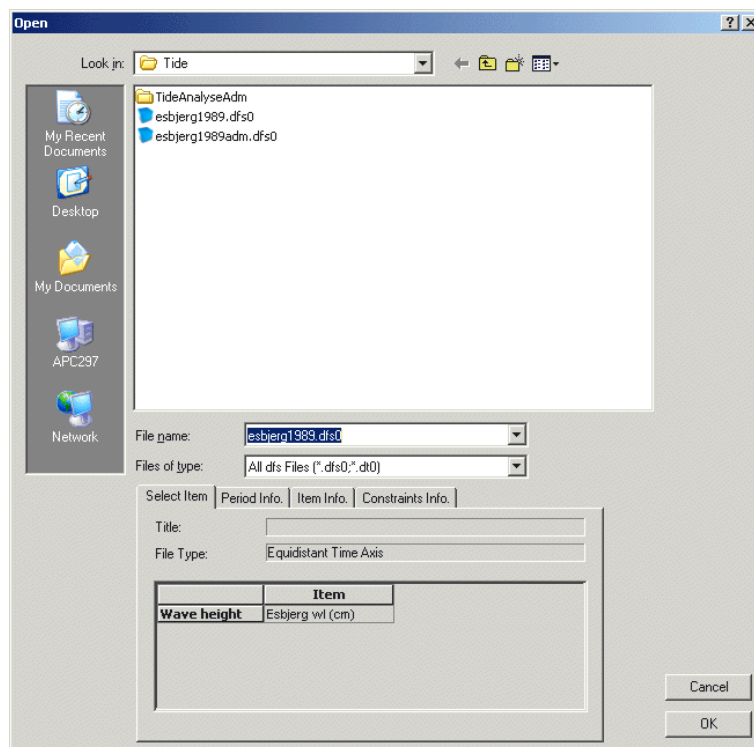
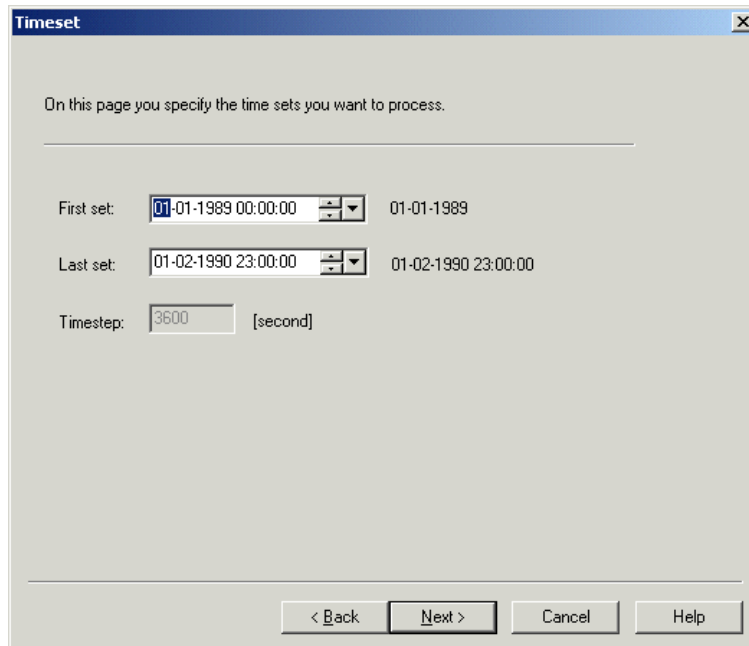
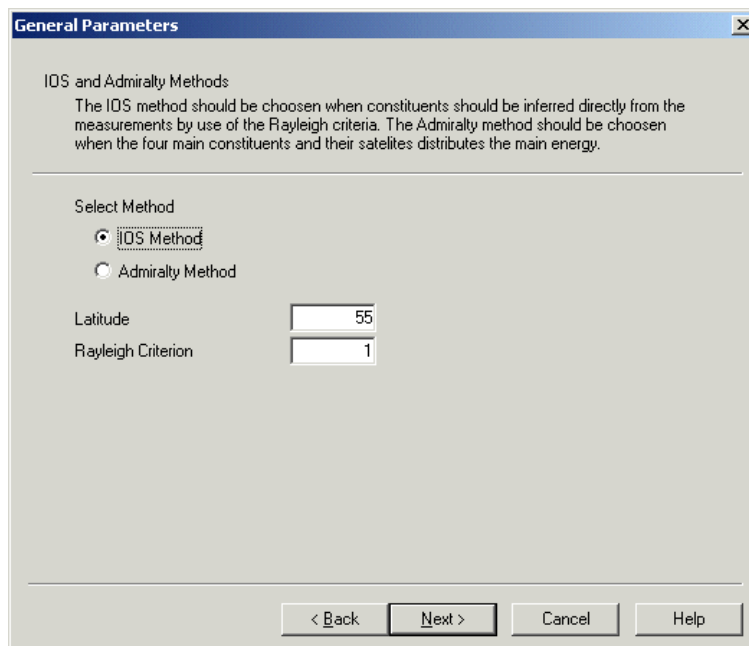

Figure 5.12 Select the time series to be analysed



The screenshot shows a dialog box titled "Timeset" with a close button (X) in the top right corner. The main text reads: "On this page you specify the time sets you want to process." Below this, there are three input fields: "First set:" with a date-time picker set to "01-01-1989 00:00:00" and a label "01-01-1989"; "Last set:" with a date-time picker set to "01-02-1990 23:00:00" and a label "01-02-1990 23:00:00"; and "Timestep:" with a text box containing "3600" and a label "[second]". At the bottom, there are four buttons: "< Back", "Next >", "Cancel", and "Help".

Figure 5.13 Specify the period to be analysed



The screenshot shows a dialog box titled "General Parameters" with a close button (X) in the top right corner. The main text reads: "IOS and Admiralty Methods" followed by a paragraph: "The IOS method should be chosen when constituents should be inferred directly from the measurements by use of the Rayleigh criteria. The Admiralty method should be chosen when the four main constituents and their satellites distributes the main energy." Below this, there is a "Select Method" section with two radio buttons: "IOS Method" (which is selected) and "Admiralty Method". Underneath, there are two input fields: "Latitude" with a value of "55" and "Rayleigh Criterion" with a value of "1". At the bottom, there are four buttons: "< Back", "Next >", "Cancel", and "Help".

Figure 5.14 Select the Analysis Method. For the IOS method specify the Latitude and Rayleigh Criteria.

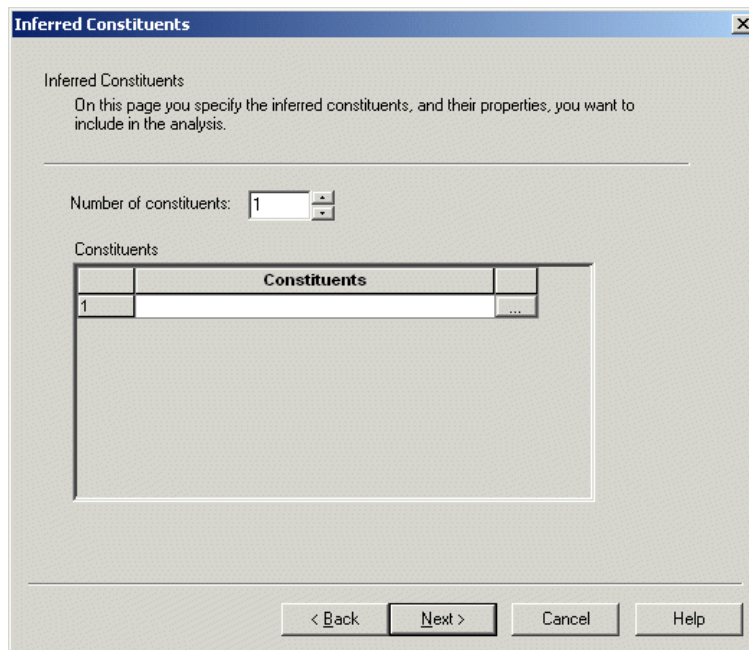

Figure 5.15 Specify any interfered constituents

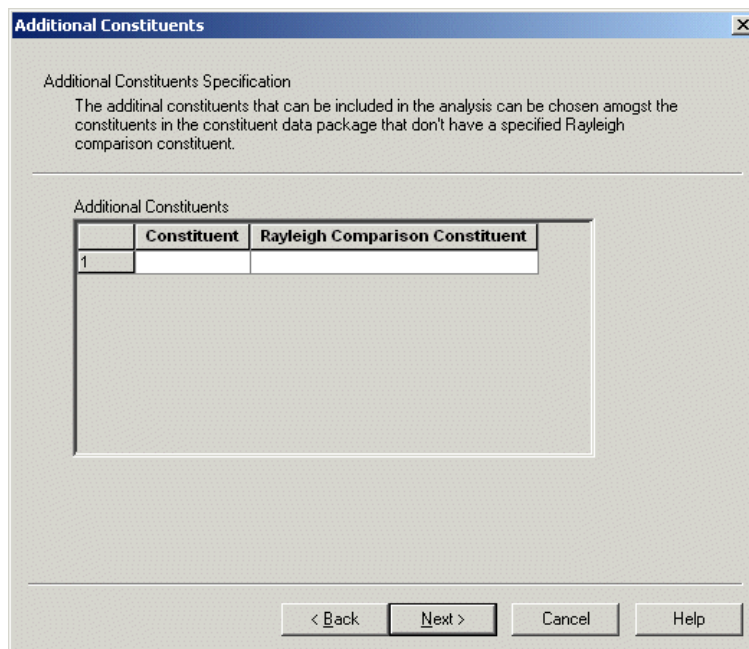

Figure 5.16 Specify any additional Constituents, which do not have a specified Rayleigh comparison constituent

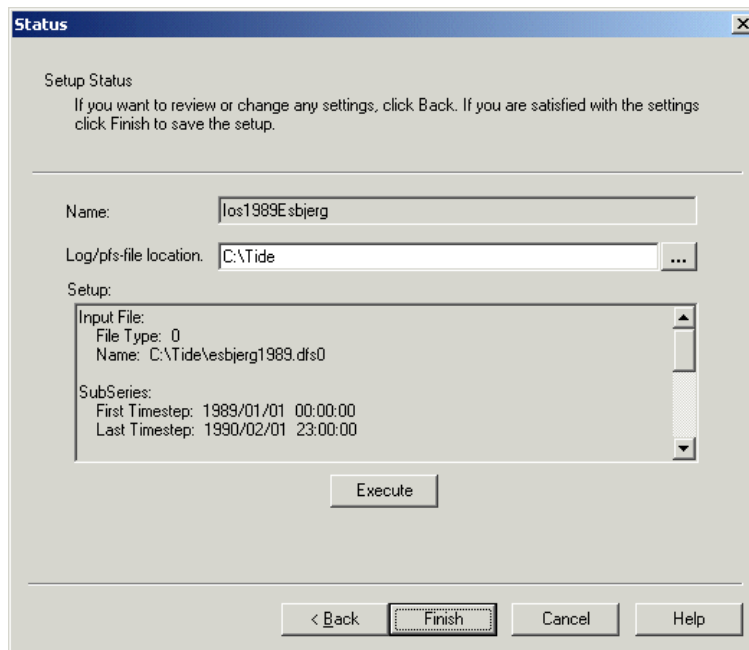

Figure 5.17 Specify location of log file and execute the program.

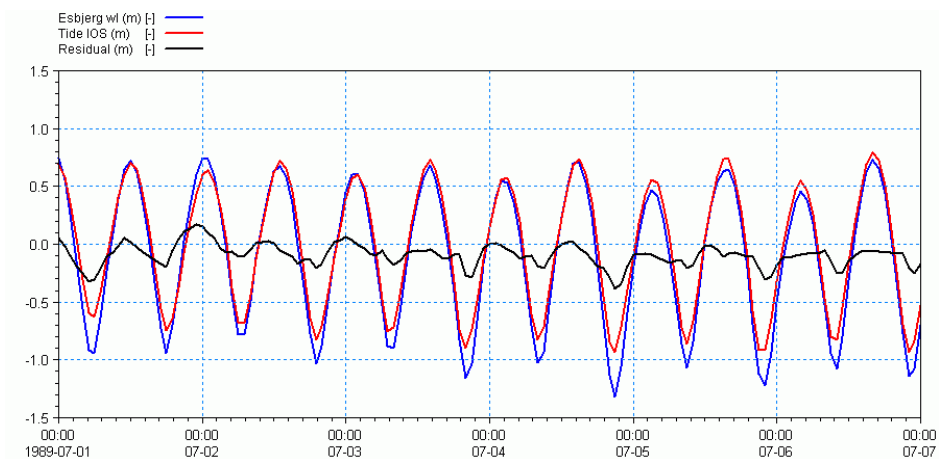
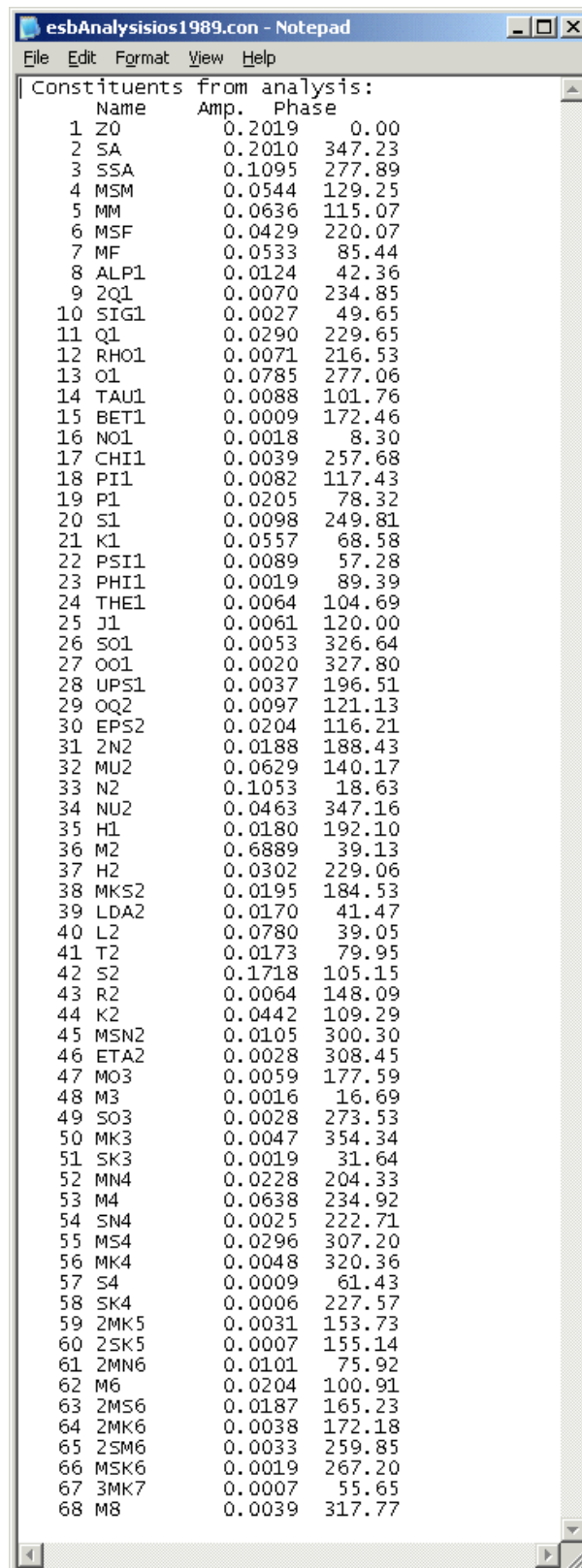

Figure 5.18 Example of Residual output file. The file include the measured values the calculated tide and the residual, the difference between the calculated and the measured tide



Constituents from analysis:		
Name	Amp.	Phase
1 Z0	0.2019	0.00
2 SA	0.2010	347.23
3 SSA	0.1095	277.89
4 MSM	0.0544	129.25
5 MM	0.0636	115.07
6 MSF	0.0429	220.07
7 MF	0.0533	85.44
8 ALP1	0.0124	42.36
9 2Q1	0.0070	234.85
10 SIG1	0.0027	49.65
11 Q1	0.0290	229.65
12 RHO1	0.0071	216.53
13 O1	0.0785	277.06
14 TAU1	0.0088	101.76
15 BET1	0.0009	172.46
16 NO1	0.0018	8.30
17 CHI1	0.0039	257.68
18 PI1	0.0082	117.43
19 P1	0.0205	78.32
20 S1	0.0098	249.81
21 K1	0.0557	68.58
22 PSI1	0.0089	57.28
23 PHI1	0.0019	89.39
24 THE1	0.0064	104.69
25 J1	0.0061	120.00
26 SO1	0.0053	326.64
27 OO1	0.0020	327.80
28 UPS1	0.0037	196.51
29 OQ2	0.0097	121.13
30 EPS2	0.0204	116.21
31 2N2	0.0188	188.43
32 MU2	0.0629	140.17
33 N2	0.1053	18.63
34 NU2	0.0463	347.16
35 H1	0.0180	192.10
36 M2	0.6889	39.13
37 H2	0.0302	229.06
38 MKS2	0.0195	184.53
39 LDA2	0.0170	41.47
40 L2	0.0780	39.05
41 T2	0.0173	79.95
42 S2	0.1718	105.15
43 R2	0.0064	148.09
44 K2	0.0442	109.29
45 MSN2	0.0105	300.30
46 ETA2	0.0028	308.45
47 MO3	0.0059	177.59
48 M3	0.0016	16.69
49 SO3	0.0028	273.53
50 MK3	0.0047	354.34
51 SK3	0.0019	31.64
52 MN4	0.0228	204.33
53 M4	0.0638	234.92
54 SN4	0.0025	222.71
55 MS4	0.0296	307.20
56 MK4	0.0048	320.36
57 S4	0.0009	61.43
58 SK4	0.0006	227.57
59 2MK5	0.0031	153.73
60 2SK5	0.0007	155.14
61 2MN6	0.0101	75.92
62 M6	0.0204	100.91
63 2MS6	0.0187	165.23
64 2MK6	0.0038	172.18
65 2SM6	0.0033	259.85
66 MSK6	0.0019	267.20
67 3MK7	0.0007	55.65
68 M8	0.0039	317.77

Figure 5.19 As an optional output, you can get the actual calculated constituent, see the example above

6 Acknowledgement

DHI acknowledges that part of the software described in this manual has been developed at the Institute of Ocean Sciences by M.G.G. Foreman and it is included in the MIKE 21 package under concession.

DHI accepts that the software developed by IOS has been modified for use in this package and assumes full responsibility for its correct functioning, in the context of the conditions stated in the "Limited Liability" clause presented on the first page of this manual.

For further information concerning the numerical methods used in the programs, please refer to the published works of M.G.G. Foreman or contact:

Institute of Ocean Sciences
P.O. Box 6000
9860 West Saanich Toad
Sidney, British Columbia
Canada V8L 4B2

Assistance in the use of the software package is supported entirely by DHI, in accordance with the standard service agreements.

7 References

- /1/ Cartwright, D.E. and Edden, A.C. Corrected Tables of Tidal Harmonics. Geophys. J.R. Astr. Soc., 33, 1973.
- /2/ Cartwright, D.E. and Taylor, R.J. New Computations of the Tide-Generating Potential. Geophys. J.R. Astr. Soc., 23, 1971.
- /3/ Danish Hydraulic Institute. Coastal Hydraulics and Oceanography. MIKE 21 Hydrodynamic Module. User's Guide and Reference Manual, 1990.
- /4/ Doodson, A.T. The Harmonic Development of the Tide-Generating Potential. Proc. Roy. Soc. Series A, 100, 1921.
- /5/ Doodson, A.T. and Warbrug, H.D. Admiralty Manual of Tides. Her Majesty's Stationery Office, London, 1941.
- /6/ Foreman, M.G. Manual for Tidal Heights Analysis and Prediction. Pacific Marine Science Report 77-10, Institute of Ocean Sciences, Canada, 1977.
- /7/ Foreman, M.G. Manual for Tidal Currents Analysis and Prediction. Pacific Marine Science Report 78-6, Institute of Ocean Sciences, Canada, 1978.
- /8/ Franco, A.S. Tides: Fundamentals, Analysis and Prediction. Instituto de Pesquisas Tecnológicas do Estado de S. Paulo. Publication No. 1182, Brazil, 1981.
- /9/ Godin, G. The Analysis of Tides. University of Toronto Press, Toronto, 1972.
- /10/ Her Majesty's Nautical Almanac Office. Explanatory Supplement to the Astronomical Ephemeris and the American Ephemeris and Nautical Almanac. Her Majesty's Stationery Office, London, 1961.
- /11/ Her Majesty's Nautical Almanac Office. The Astronomical Ephemeris. Her Majesty's Stationery Office, London, 1974.
- /12/ Hicks, S.D. Tide and Current Glossary. US National Oceanic and Atmospheric Administration, 1984.
- /13/ Hydrographer of the Navy. Simplified Harmonic Method of Tidal Prediction, book of forms with Instructions and Example. NP159.
- /14/ International Hydrographic Organisation. Hydrographic Dictionary, Part I, 1974.
- /15/ Lisitzin, E. Sea Level Changes. Elsevier Oceanography Series, 8. Elsevier, Amsterdam, 1974.
- /16/ Munk, W.H. and Cartwright, D.E. Tidal Spectroscopy and Prediction. Philosophical Transactions of the Royal Society of London, Series A, 259, 1966.
- /17/ Pugh, D.T. Tides, Surges and Mean Sea-Level. A Handbook for Engineers and Scientists. John Willy & Sons, 1987.
- /18/ Schureman, P. Manual of Harmonic Analysis and Prediction of Tides. US Government Printing Office, Washington, 1976.

- /19/ UK Hydrographic Office. Admiralty of Tides (WP120). Kelvin Hughes, Ed. 1/1961.

APPENDICES

APPENDIX A

Constituent Data Package

A Constituent Data Package

A listing of the file containing the constituent information is presented in this appendix. The data is organised in four main groups as follows:

- a. A list of all the possible constituents to be included in the analysis, their frequencies in cycles/hour and the constituent with which they should be compared according to the Rayleigh criterion. A blank data field for the comparison constituent implies that the corresponding constituent is not being included in the analysis unless specifically designated in the input files.
- b. The values for the astronomical arguments s , p , h , N' and p' and their respective rates of change over a 365-day period at the reference time origin (January 1, 1976).
- c. The Doodson numbers for all the main tidal constituents and information on the satellite constituents. The first line for each constituent contains the following information:
 - The constituent name
 - The six Doodson numbers of the constituent
 - The phase correction for the constituent
 - The number of satellite constituents (NJ).
If $NJ > 0$, information on the satellite constituents follows, three satellites per line. For each satellite the values read are:
 - The last three Doodson numbers of the main constituent subtracted from the last three Doodson numbers of the satellite constituent.
 - The phase correction of the satellite constituent relative to the phase of the main constituent
 - The amplitude ratio of the satellite tidal potential to that of the main constituent
 - R1, if the amplitude ratio has to be multiplied by the latitude correction factor for diurnal constituents
 - R2, if the amplitude ratio has to be multiplied by the latitude correction factor for semidiurnal constituent
- d. List of shallow water constituents and of the main tidal constituents from which they are derived. The respective variables are:
 - The name of the shallow water constituent. The number of main constituents from which it is derived.
 - Combination number and name of these main constituents.

The constituent data package for the prediction programs does not include the first group of data. Therefore, in the prediction programs the constituent frequencies are calculated via the derivatives of the astronomical variables and the constituent Doodson numbers.

Z0	0.0	M2	
SA	0.0001140741	SSA	
SSA	0.0002281591	Z0	cycles/hour
MSM	0.0013097808	MM	
MM	0.0015121518	MSF	
MSF	0.0028219327	Z0	
MF	0.0030500918	MSF	
ALP1	0.0343965699	2Q1	
2Q1	0.0357063507	Q1	
SIG1	0.0359087218	2Q1	
Q1	0.0372185026	O1	
RHO1	0.0374208736	Q1	
O1	0.0387306544	K1	
TAU1	0.0389588136	O1	
BET1	0.0400404353	NO1	
NO1	0.0402685944	K1	
CHI1	0.0404709654	NO1	
PI1	0.0414385130	P1	
P1	0.0415525871	K1	
S1	0.0416666721	K1	
K1	0.0417807462	Z0	
PSI1	0.0418948203	K1	
PHI1	0.0420089053	K1	
THE1	0.0430905270	J1	
J1	0.0432928981	K1	
2PO1	0.0443745198		
SO1	0.0446026789	OO1	
OO1	0.0448308380	J1	
UPS1	0.0463429898	OO1	
ST36	0.0733553835		
2NS2	0.0746651643		
ST37	0.0748675353		
ST1	0.0748933234		
OQ2	0.0759749451	EPS2	
EPS2	0.0761773161	2N2	
ST2	0.0764054753		
ST3	0.0772331498		
O2	0.0774613089		
2N2	0.0774870970	MU2	
MU2	0.0776894680	N2	
SNK2	0.0787710897		
N2	0.0789992488	M2	
NU2	0.0792016198	N2	
ST4	0.0794555670		
OP2	0.0802832416		
GAM2	0.0803090296	H1	
H1	0.0803973266	M2	
M2	0.0805114007	Z0	
H2	0.0806254748	M2	
MKS2	0.0807395598	M2	
ST5	0.0809677189		
ST6	0.0815930224		
LDA2	0.0818211815	L2	
L2	0.0820235525	S2	
2SK2	0.0831051742		
T2	0.0832192592	S2	
S2	0.0833333333	M2	
R2	0.0834474074	S2	
K2	0.0835614924	S2	
MSN2	0.0848454852	ETA2	
ETA2	0.0850736443	K2	
ST7	0.0853018034		
2SM2	0.0861552660		
ST38	0.0863576370		
SKM2	0.0863834251		

2SN2	0.0876674179	
NO3	0.1177299033	
MO3	0.1192420551	M3
M3	0.1207671010	M2
NK3	0.1207799950	
SO3	0.1220639878	MK3
MK3	0.1222921469	M3
SP3	0.1248859204	
SK3	0.1251140796	MK3
ST8	0.1566887168	
N4	0.1579984976	
3MS4	0.1582008687	
ST39	0.1592824904	
MN4	0.1595106495	M4
ST9	0.1597388086	
ST40	0.1607946422	
M4	0.1610228013	M3
ST10	0.1612509604	
SN4	0.1623325821	M4
KN4	0.1625607413	
MS4	0.1638447340	M4
MK4	0.1640728931	MS4
SL4	0.1653568858	
S4	0.1666666667	MS4
SK4	0.1668948258	S4
MNO5	0.1982413039	
2MO5	0.1997534558	
3MP5	0.1999816149	
MNK5	0.2012913957	
2MP5	0.2025753884	
2MK5	0.2028035475	M4
MSK5	0.2056254802	
3KM5	0.2058536393	
2SK5	0.2084474129	2MK5
ST11	0.2372259056	
2NM6	0.2385098983	
ST12	0.2387380574	
2MN6	0.2400220501	M6
ST13	0.2402502093	
ST41	0.2413060429	
M6	0.2415342020	2MK5
MSN6	0.2428439828	
MKN6	0.2430721419	
ST42	0.2441279756	
2MS6	0.2443561347	M6
2MK6	0.2445842938	2MS6
NSK6	0.2458940746	
2SM6	0.2471780673	2MS6
MSK6	0.2474062264	2SM6
S6	0.2500000000	
ST14	0.2787527046	
ST15	0.2802906445	
M7	0.2817899023	
ST16	0.2830867891	
3MK7	0.2833149482	M6
ST17	0.2861368809	
ST18	0.3190212990	
3MN8	0.3205334508	
ST19	0.3207616099	
M8	0.3220456027	3MK7
ST20	0.3233553835	
ST21	0.3235835426	
3MS8	0.3248675353	
3MK8	0.3250956944	
ST22	0.3264054753	
ST23	0.3276894680	
ST24	0.3279176271	

ST25	0.3608020452												
ST26	0.3623141970												
4MK9	0.3638263489												
ST27	0.3666482815												
ST28	0.4010448515												
M10	0.4025570033												
ST29	0.4038667841												
ST30	0.4053789360												
ST31	0.4069168759												
ST32	0.4082008687												
ST33	0.4471596822												
M12	0.4830684040												
ST34	0.4858903367												
ST35	0.4874282766												
.													
.7428797055	.7771900329	.5187051308	.3631582592	.7847990160	000GMT 1/1/76								
13.3594019864	.9993368945	.1129517942	.0536893056	.0000477414	INCR./365DAYS								
Z0	0	0	0	0	0	0	0.0	0					
SA	0	0	1	0	0	-1	0.0	0					
SSA	0	0	2	0	0	0	0.0	0					
MSM	0	1	-2	1	0	0	.00	0					
MM	0	1	0	-1	0	0	0.0	0					
MSF	0	2	-2	0	0	0	0.0	0					
MF	0	2	0	0	0	0	0.0	0					
ALP1	1	-4	2	1	0	0	-0.25	2					
ALP1	-1	0	0	.75	0.0360R1	0	-1	0	.00	0.1906			
2Q1	1	-3	0	2	0	0	-0.25	5					
2Q1	-2	-2	0	.50	0.0063	-1	-1	0	.75	0.0241R1	-1	0	0 .75 0.0607R1
2Q1	0	-2	0	.50	0.0063	0	-1	0	.0	0.1885			
SIG1	1	-3	2	0	0	0	-0.25	4					
SIG1	-1	0	0	.75	0.0095R1	0	-2	0	.50	0.0061	0	-1	0 .0 0.1884
SIG1	2	0	0	.50	0.0087								
Q1	1	-2	0	1	0	0	-0.25	10					
Q1	-2	-3	0	.50	0.0007	-2	-2	0	.50	0.0039	-1	-2	0 .75 0.0010R1
Q1	-1	-1	0	.75	0.0115R1	-1	0	0	.75	0.0292R1	0	-2	0 .50 0.0057
Q1	-1	0	1	.0	0.0008	0	-1	0	.0	0.1884	1	0	0 .75 0.0018R1
Q1	2	0	0	.50	0.0028								
RHO1	1	-2	2	-1	0	0	-0.25	5					
RHO1	0	-2	0	.50	0.0058	0	-1	0	.0	0.1882	1	0	0 .75 0.0131R1
RHO1	2	0	0	.50	0.0576	2	1	0	.0	0.0175			
O1	1	-1	0	0	0	0	-0.25	8					
O1	-1	0	0	.25	0.0003R1	0	-2	0	.50	0.0058	0	-1	0 .0 0.1885
O1	1	-1	0	.25	0.0004R1	1	0	0	.75	0.0029R1	1	1	0 .25 0.0004R1
O1	2	0	0	.50	0.0064	2	1	0	.50	0.0010			
TAU1	1	-1	2	0	0	0	-0.75	5					
TAU1	-2	0	0	.0	0.0446	-1	0	0	.25	0.0426R1	0	-1	0 .50 0.0284
TAU1	0	1	0	.50	0.2170	0	2	0	.50	0.0142			
BET1	1	0	-2	1	0	0	-.75	1					
BET1	0	-1	0	.00	0.2266								
NO1	1	0	0	1	0	0	-0.75	9					
NO1	-2	-2	0	.50	0.0057	-2	-1	0	.0	0.0665	-2	0	0 .0 0.3596
NO1	-1	-1	0	.75	0.0331R1	-1	0	0	.25	0.2227R1	-1	1	0 .75 0.0290R1
NO1	0	-1	0	.50	0.0290	0	1	0	.0	0.2004	0	2	0 .50 0.0054
CHI1	1	0	2	-1	0	0	-0.75	2					
CHI1	0	-1	0	.50	0.0282	0	1	0	.0	0.2187			
PI1	1	1	-3	0	0	1	-0.25	1					
PI1	0	-1	0	.50	0.0078								
P1	1	1	-2	0	0	0	-0.25	6					
P1	0	-2	0	.0	0.0008	0	-1	0	.50	0.0112	0	0	2 .50 0.0004
P1	1	0	0	.75	0.0004R1	2	0	0	.50	0.0015	2	1	0 .50 0.0003
S1	1	1	-1	0	0	1	-0.75	2					
S1	0	0	-2	.0	0.3534	0	1	0	.50	0.0264			
K1	1	1	0	0	0	0	-0.75	10					
K1	-2	-1	0	.0	0.0002	-1	-1	0	.75	0.0001R1	-1	0	0 .25 0.0007R1
K1	-1	1	0	.75	0.0001R1	0	-2	0	.0	0.0001	0	-1	0 .50 0.0198
K1	0	1	0	.0	0.1356	0	2	0	.50	0.0029	1	0	0 .25 0.0002R1
K1	1	1	0	.25	0.0001R1								

```

PSI1 1 1 1 0 0 -1-0.75 1
PSI1 0 1 0 .0 0.0190
PHI1 1 1 2 0 0 0-0.75 5
PHI1 -2 0 0 .0 0.0344 -2 1 0 .0 0.0106 0 0 -2 .0 0.0132
PHI1 0 1 0 .50 0.0384 0 2 0 .50 0.0185
THE1 1 2 -2 1 0 0 -.75 4
THE1 -2 -1 0 .00 .0300 -1 0 0 .25 0.0141R1 0 -1 0 .50 .0317
THE1 0 1 0 .00 .1993
J1 1 2 0 -1 0 0-0.75 10
J1 0 -1 0 .50 0.0294 0 1 0 .0 0.1980 0 2 0 .50 0.0047
J1 1 -1 0 .75 0.0027R1 1 0 0 .25 0.0816R1 1 1 0 .25 0.0331R1
J1 1 2 0 .25 0.0027R1 2 0 0 .50 0.0152 2 1 0 .50 0.0098
J1 2 2 0 .50 0.0057
OO1 1 3 0 0 0 0-0.75 8
OO1 -2 -1 0 .50 0.0037 -2 0 0 .0 0.1496 -2 1 0 .0 0.0296
OO1 -1 0 0 .25 0.0240R1 -1 1 0 .25 0.0099R1 0 1 0 .0 0.6398
OO1 0 2 0 .0 0.1342 0 3 0 .0 0.0086
UPS1 1 4 0 -1 0 0 -.75 5
UPS1 -2 0 0 .00 0.0611 0 1 0 .00 0.6399 0 2 0 .00 0.1318
UPS1 1 0 0 .25 0.0289R1 1 1 0 .25 0.0257R1
OQ2 2 -3 0 3 0 0 0.0 2
OQ2 -1 0 0 .25 0.1042R2 0 -1 0 .50 0.0386
EPS2 2 -3 2 1 0 0 0.0 3
EPS2 -1 -1 0 .25 0.0075R2 -1 0 0 .25 0.0402R2 0 -1 0 .50 0.0373
2N2 2 -2 0 2 0 0 0.0 4
2N2 -2 -2 0 .50 0.0061 -1 -1 0 .25 0.0117R2 -1 0 0 .25 0.0678R2
2N2 0 -1 0 .50 0.0374
MU2 2 -2 2 0 0 0 0.0 3
MU2 -1 -1 0 .25 0.0018R2 -1 0 0 .25 0.0104R2 0 -1 0 .50 0.0375
N2 2 -1 0 1 0 0 0.0 4
N2 -2 -2 0 .50 0.0039 -1 0 1 .00 0.0008 0 -2 0 .00 0.0005
N2 0 -1 0 .50 0.0373
NU2 2 -1 2 -1 0 0 0.0 4
NU2 0 -1 0 .50 0.0373 1 0 0 .75 0.0042R2 2 0 0 .0 0.0042
NU2 2 1 0 .50 0.0036
GAM2 2 0 -2 2 0 0 -.50 3
GAM2 -2 -2 0 .00 0.1429 -1 0 0 .25 0.0293R2 0 -1 0 .50 0.0330
H1 2 0 -1 0 0 1-0.50 2
H1 0 -1 0 .50 0.0224 1 0 -1 .50 0.0447
M2 2 0 0 0 0 0 0.0 9
M2 -1 -1 0 .75 0.0001R2 -1 0 0 .75 0.0004R2 0 -2 0 .0 0.0005
M2 0 -1 0 .50 0.0373 1 -1 0 .25 0.0001R2 1 0 0 .75 0.0009R2
M2 1 1 0 .75 0.0002R2 2 0 0 .0 0.0006 2 1 0 .0 0.0002
H2 2 0 1 0 0 -1 0.0 1
H2 0 -1 0 .50 0.0217
LDA2 2 1 -2 1 0 0-0.50 1
LDA2 0 -1 0 .50 0.0448
L2 2 1 0 -1 0 0-0.50 5
L2 0 -1 0 .50 0.0366 2 -1 0 .00 0.0047 2 0 0 .50 0.2505
L2 2 1 0 .50 0.1102 2 2 0 .50 0.0156
T2 2 2 -3 0 0 1 0.0 0
S2 2 2 -2 0 0 0 0.0 3
S2 0 -1 0 .0 0.0022 1 0 0 .75 0.0001R2 2 0 0 .0 0.0001
R2 2 2 -1 0 0 -1-0.50 2
R2 0 0 2 .50 0.2535 0 1 2 .0 0.0141
K2 2 2 0 0 0 0 0.0 5
K2 -1 0 0 .75 0.0024R2 -1 1 0 .75 0.0004R2 0 -1 0 .50 0.0128
K2 0 1 0 .0 0.2980 0 2 0 .0 0.0324
ETA2 2 3 0 -1 0 0 0.0 7
ETA2 0 -1 0 .50 0.0187 0 1 0 .0 0.4355 0 2 0 .0 0.0467
ETA2 1 0 0 .75 0.0747R2 1 1 0 .75 0.0482R2 1 2 0 .75 0.0093R2
ETA2 2 0 0 .50 0.0078
M3 3 0 0 0 0 0 -.50 1
M3 0 -1 0 .50 .0564

2PO1 2 2.0 P1 -1.0 O1
SO1 2 1.0 S2 -1.0 O1
    
```

ST36	3	2.0	M2	1.0	N2	-2.0	S2	
2NS2	2	2.0	N2	-1.0	S2			
ST37	2	3.0	M2	-2.0	S2			
ST1	3	2.0	N2	1.0	K2	-2.0	S2	
ST2	4	1.0	M2	1.0	N2	1.0	K2	-2.0 S2
ST3	3	2.0	M2	1.0	S2	-2.0	K2	
O2	1	2.0	O1					
ST4	3	2.0	K2	1.0	N2	-2.0	S2	
SNK2	3	1.0	S2	1.0	N2	-1.0	K2	
OP2	2	1.0	O1	1.0	P1			
MKS2	3	1.0	M2	1.0	K2	-1.0	S2	
ST5	3	1.0	M2	2.0	K2	-2.0	S2	
ST6	4	2.0	S2	1.0	N2	-1.0	M2	-1.0 K2
2SK2	2	2.0	S2	-1.0	K2			
MSN2	3	1.0	M2	1.0	S2	-1.0	N2	
ST7	4	2.0	K2	1.0	M2	-1.0	S2	-1.0 N2
2SM2	2	2.0	S2	-1.0	M2			
ST38	3	2.0	M2	1.0	S2	-2.0	N2	
SKM2	3	1.0	S2	1.0	K2	-1.0	M2	
2SN2	2	2.0	S2	-1.0	N2			
NO3	2	1.0	N2	1.0	O1			
MO3	2	1.0	M2	1.0	O1			
NK3	2	1.0	N2	1.0	K1			
SO3	2	1.0	S2	1.0	O1			
MK3	2	1.0	M2	1.0	K1			
SP3	2	1.0	S2	1.0	P1			
SK3	2	1.0	S2	1.0	K1			
ST8	3	2.0	M2	1.0	N2	-1.0	S2	
N4	1	2.0	N2					
3MS4	2	3.0	M2	-1.0	S2			
ST39	4	1.0	M2	1.0	S2	1.0	N2	-1.0 K2
MN4	2	1.0	M2	1.0	N2			
ST40	3	2.0	M2	1.0	S2	-1.0	K2	
ST9	4	1.0	M2	1.0	N2	1.0	K2	-1.0 S2
M4	1	2.0	M2					
ST10	3	2.0	M2	1.0	K2	-1.0	S2	
SN4	2	1.0	S2	1.0	N2			
KN4	2	1.0	K2	1.0	N2			
MS4	2	1.0	M2	1.0	S2			
MK4	2	1.0	M2	1.0	K2			
SL4	2	1.0	S2	1.0	L2			
S4	1	2.0	S2					
SK4	2	1.0	S2	1.0	K2			
MNO5	3	1.0	M2	1.0	N2	1.0	O1	
2MO5	2	2.0	M2	1.0	O1			
3MP5	2	3.0	M2	-1.0	P1			
MNK5	3	1.0	M2	1.0	N2	1.0	K1	
2MP5	2	2.0	M2	1.0	P1			
2MK5	2	2.0	M2	1.0	K1			
MSK5	3	1.0	M2	1.0	S2	1.0	K1	
3KM5	3	1.0	K2	1.0	K1	1.0	M2	
2SK5	2	2.0	S2	1.0	K1			
ST11	3	3.0	N2	1.0	K2	-1.0	S2	
2NM6	2	2.0	N2	1.0	M2			
ST12	4	2.0	N2	1.0	M2	1.0	K2	-1.0 S2
ST41	3	3.0	M2	1.0	S2	-1.0	K2	
2MN6	2	2.0	M2	1.0	N2			
ST13	4	2.0	M2	1.0	N2	1.0	K2	-1.0 S2
M6	1	3.0	M2					
MSN6	3	1.0	M2	1.0	S2	1.0	N2	
MKN6	3	1.0	M2	1.0	K2	1.0	N2	
2MS6	2	2.0	M2	1.0	S2			
2MK6	2	2.0	M2	1.0	K2			
NSK6	3	1.0	N2	1.0	S2	1.0	K2	
2SM6	2	2.0	S2	1.0	M2			
MSK6	3	1.0	M2	1.0	S2	1.0	K2	
ST42	3	2.0	M2	2.0	S2	-1.0	K2	

S6	1	3.0	S2				
ST14	3	2.0	M2	1.0	N2	1.0	O1
ST15	3	2.0	N2	1.0	M2	1.0	K1
M7	1	3.5	M2				
ST16	3	2.0	M2	1.0	S2	1.0	O1
3MK7	2	3.0	M2	1.0	K1		
ST17	4	1.0	M2	1.0	S2	1.0	K2
ST18	2	2.0	M2	2.0	N2		1.0 O1
3MN8	2	3.0	M2	1.0	N2		
ST19	4	3.0	M2	1.0	N2	1.0	K2
M8	1	4.0	M2				-1.0 S2
ST20	3	2.0	M2	1.0	S2	1.0	N2
ST21	3	2.0	M2	1.0	N2	1.0	K2
3MS8	2	3.0	M2	1.0	S2		
3MK8	2	3.0	M2	1.0	K2		
ST22	4	1.0	M2	1.0	S2	1.0	N2
ST23	2	2.0	M2	2.0	S2		1.0 K2
ST24	3	2.0	M2	1.0	S2	1.0	K2
ST25	3	2.0	M2	2.0	N2	1.0	K1
ST26	3	3.0	M2	1.0	N2	1.0	K1
4MK9	2	4.0	M2	1.0	K1		
ST27	3	3.0	M2	1.0	S2	1.0	K1
ST28	2	4.0	M2	1.0	N2		
M10	1	5.0	M2				
ST29	3	3.0	M2	1.0	N2	1.0	S2
ST30	2	4.0	M2	1.0	S2		
ST31	4	2.0	M2	1.0	N2	1.0	S2
ST32	2	3.0	M2	2.0	S2		1.0 K2
ST33	3	4.0	M2	1.0	S2	1.0	K1
M12	1	6.0	M2				
ST34	2	5.0	M2	1.0	S2		
ST35	4	3.0	M2	1.0	N2	1.0	K2
							1.0 S2

APPENDIX B

Glossary

B Glossary

Amphidrome

A region where the tide rotates around a point of zero tidal amplitude. This phenomena is due to the interaction of tidal waves propagating in opposite directions, as a consequence of reflections on the coast and of the Coriolis effect. Cotidal lines radiate from an amphidromic point and corange lines encircle it. In general terms an amphidromic point is present in any system of standing Kelvin waves.

Aphelion

The farthest position of the earth from the sun.

Apogee

The position of the moon when it is farthest to the earth.

Coamplitude lines

Lines along which the amplitude or the range of tidal displacements are equal; also called corange lines. Usually drawn for a particular tidal constituent or tidal condition (for example, mean spring tides).

Cotidal lines

Lines along which the highest water levels occur simultaneously. Usually drawn for a particular tidal constituent or tidal condition.

Currents

Non-periodical movements of water, due to many different causes such as temperature gradients and wind shear stresses.

Declination

The angular distance of an astronomical body north (+) or south (-) of the celestial equator. The sun moves through a declinational cycle once a year, the declination varying between 23.5oN and 23.5oS. The cycles of the lunar declination (27.21 mean solar days) vary in amplitude over an 18.6-year period from 28.5o to 18.5o.

Ecliptic

The plane in which the earth revolves about the sun. The plane of the moon's orbit around the earth and the axis of the earth are inclined to the ecliptic plane at 5o9' and 66o, respectively.

Ephemeris time

Is the uniform measure of time defined by the laws of dynamics and determined in principle from the orbital motion of the earth as represented by Newcomb's Tables of the sun. Universal or Greenwich Mean Time is defined by the rotational motion of the earth and is not rigorously uniform.

Equilibrium tide

The hypothetical tide produced by the lunar and solar tidal forces, which would occur in a non-inertial ocean covering the whole earth.

Equinoxes

The two points in the celestial sphere where the celestial equator intersects the ecliptic; also the times when the sun crosses the equator at these points. The vernal equinox is the point where the sun crosses the equator from south to north and it occurs about 21 March. Celestial longitude is reckoned eastwards from the vernal equinox, which is also known as the 'first point of Aries'. The autumnal equinox occurs about 23 September.

First point of Aries

See Equinoxes.

Gravitation, Newton's law of

States that the force of attraction between any two particles in the Universe is proportional to the product of their masses and inversely proportional to the square of the distance between the particles.

Greenwich Mean Time

Time expressed with respect to the Greenwich Meridian (0o) often used as a standard for comparison of global geophysical phenomena.

Harmonic analysis

The transformation of tidal observations from the time domain to the frequency domain. The tidal variations can then be given by the sum of the harmonic constituents, which period is associated with the period of the tide generating forces. The periods fall into three tidal species (long-period, diurnal and semidiurnal). Each tidal species contains groups of harmonics, which can be separated by analysis of a month of observations. In turn, each group contains constituents, which can be separated by analysis of a year of observations. Third-diurnal, fourth-diurnal and higher species of harmonics are generated by shallow water effects.

High water

The highest level reached by the water surface in a tidal cycle.

Highest astronomical tide

The highest level, which can be predicted to occur under any combination of astronomical conditions.

Kelvin wave

A long wave propagating under the Coriolis effect, where transverse currents are prevented to occur by transverse surface gradients. In the northern hemisphere the amplitude of the wave decreases from right to left along the crest (viewed in the direction of wave travelling).

Long wave

A wave whose wave-length from crest to crest is long compared with the water depth. Tides propagate as long waves. The travelling speed is given by the square root of water depth \times gravitational acceleration.

Low water

The lowest water level reached by the water surface in a tidal cycle.

Lowest astronomical tide

The lowest level which can be predicted to occur under average meteorological conditions and under any combination of astronomical conditions; often used to define Chart Datum where the tides are semi-diurnal.

Mean high water springs

The average spring tide high water level, averaged over a sufficiently long period.

Mean low water springs

The average spring low-water level averaged over a sufficiently long period.

Mean sea level

A tidal datum; the arithmetic mean of hourly heights observed over some specified period (often 19 years). Equivalent to the level which would have existed in the absence of tidal forces.

Neap tides

Tides of small range, which occur twice a month, when the moon is in quadrature.

Nodal factors

Factors, which take into account the effects (over a 18.6-year nodal period) of non-analysed satellites on the amplitudes and phases of the constituents calculated from a 1-year time series.

Perigee

The position of the moon when it is nearest to the earth.

Perihelion

The nearest position of the earth from the sun.

Pressure tide gauges

Instruments, which measure the pressure below the sea surface, which can be converted to sea levels if the air pressure, the gravitational acceleration and the water density are known.

Progressive wave

A wave which propagates in a water body of indefinite length, the maximum fluxes occurring under the crest (in the direction of the propagation) and the trough (in the opposite direction). Energy is transmitted but the water particles perform oscillatory motions.

Range

The difference of elevation between consecutive high and low waters in a tidal cycle. Ranges greater than 4 m are sometimes called macrotidal and those less than 2 m are called microtidal. Intermediate ranges are termed mesotidal.

Rectilinear current

See Reversing current.

Reversing current

A tidal current which flows alternately in approximately opposite directions with a slack water occurring at each reversal of direction. Also called a rectilinear current.

Seiche

Free oscillations that occur in enclosed or semi-enclosed water basins, such as lakes, gulfs, bays or harbours. The natural periods of these oscillations for rectangular basins can be determined by simple formulae (Merian, 1828) and constitute a good approximation for many practical cases. Seiches with amplitudes of up to 1 meter and periods in the order of 24 hrs can be observed in large bodies of water (e.g. Adriatic).

Sidereal day

The period of rotation of the earth with respect to the vernal equinox (approximately 0.99727 of a mean solar day).

Slack water

The state of a tidal current when its speed is near zero, especially the time when a reversing (rectilinear) current changes direction and its

speed is zero. For a theoretical standing tidal wave, slack water occurs at the times of high and of low water, while for a theoretical progressive tidal wave, slack water occurs midway between high and low water.

Spring tides

Semidiurnal tides of large range which occur twice a month, when the moon is new or full.

Standing wave

Wave motion in an enclosed or semi-enclosed sea, originated by the interaction of incident and reflected progressive waves. The amplitude of the wave is location dependent. The points with zero tidal movement are called nodes, and locations with maximum tidal amplitude are called antinodes. No energy is transmitted in a standing wave, nor is there any progression of the wave pattern.

Stillingwell gauges

Instrument system for direct measuring of sea levels through the movement of a float in a well, which is connected to the open sea by a restricted hole or narrow pipe. Wind waves are eliminated by the constriction of the connection.

Surge

Changes in sea level due to the effects of winds (tangential stresses) and atmospheric pressure gradients on the water surface.

Tidal prism

The volume of water exchanged, during a complete tidal cycle between a lagoon or estuary and the open sea.

Tidal streams

Periodical movements of the ocean water masses associated with the tides.

Tides

Periodic movements of the ocean water levels of the earth due to the gravitational attraction forces of the moon and the sun. The observed coastal tides are affected by submarine and coastal topography, resonance in bays and estuaries and forces due to the earth's rotation.

Vernal equinox

See Equinoxes.