

# MIKE 21 Flood Screening Tool

Simple MIKE 21 Solver for Inland Flooding Applications





## PLEASE NOTE

### **COPYRIGHT**

This document refers to proprietary computer software which is protected by copyright. All rights are reserved. Copying or other reproduction of this manual or the related programs is prohibited without prior written consent of DHI. For details please refer to your 'DHI Software Licence Agreement'.

### **LIMITED LIABILITY**

The liability of DHI is limited as specified in Section III of your 'DHI Software Licence Agreement':

'IN NO EVENT SHALL DHI OR ITS REPRESENTATIVES (AGENTS AND SUPPLIERS) BE LIABLE FOR ANY DAMAGES WHATSOEVER INCLUDING, WITHOUT LIMITATION, SPECIAL, INDIRECT, INCIDENTAL OR CONSEQUENTIAL DAMAGES OR DAMAGES FOR LOSS OF BUSINESS PROFITS OR SAVINGS, BUSINESS INTERRUPTION, LOSS OF BUSINESS INFORMATION OR OTHER PECUNIARY LOSS ARISING OUT OF THE USE OF OR THE INABILITY TO USE THIS DHI SOFTWARE PRODUCT, EVEN IF DHI HAS BEEN ADVISED OF THE POSSIBILITY OF SUCH DAMAGES. THIS LIMITATION SHALL APPLY TO CLAIMS OF PERSONAL INJURY TO THE EXTENT PERMITTED BY LAW. SOME COUNTRIES OR STATES DO NOT ALLOW THE EXCLUSION OR LIMITATION OF LIABILITY FOR CONSEQUENTIAL, SPECIAL, INDIRECT, INCIDENTAL DAMAGES AND, ACCORDINGLY, SOME PORTIONS OF THESE LIMITATIONS MAY NOT APPLY TO YOU. BY YOUR OPENING OF THIS SEALED PACKAGE OR INSTALLING OR USING THE SOFTWARE, YOU HAVE ACCEPTED THAT THE ABOVE LIMITATIONS OR THE MAXIMUM LEGALLY APPLICABLE SUBSET OF THESE LIMITATIONS APPLY TO YOUR PURCHASE OF THIS SOFTWARE.'





# CONTENTS

<b>1</b>	<b>About This Guide</b>	<b>9</b>
1.1	Purpose	9
1.2	Assumed User Background	9
<b>2</b>	<b>Introduction</b>	<b>11</b>
2.1	General Description	11
2.1.1	Application Areas	11
<b>3</b>	<b>Examples</b>	<b>13</b>
3.1	General	13
3.2	Donegal Bay	13
3.2.1	Purpose	13
3.2.2	Defining the Model	13
3.2.3	Setting Up the Model	14
3.2.4	Results	15
3.3	Retention Basin by River	16
3.3.1	Purpose of the Example	16
3.3.2	Defining the Hydrodynamic Model	17
3.3.3	Presenting and Evaluating the Results	21
<b>4</b>	<b>Basic Parameters Dialog Overview</b>	<b>25</b>
4.1	Bathymetry	25
4.1.1	Cold start	26
4.1.2	Hot start	26
4.1.3	Multi-cell overland solver	26
4.2	Simulation Period	26
4.3	Boundary	27
4.4	Source and Sink	27
4.5	Flood and Dry	28
<b>5</b>	<b>Dialog Overview</b>	<b>29</b>
5.1	Initial Surface Elevation	29
5.2	Boundary	29
5.3	Source and Sink	31
5.3.1	Evaporation and precipitation	31
5.4	Infiltration	32
5.4.1	Net infiltration	32
5.4.2	Constant infiltration with capacity	33
5.5	Resistance	34



5.6	Structures . . . . .	34
5.6.1	Weirs . . . . .	35
5.6.2	Culverts . . . . .	37
5.6.3	Dikes . . . . .	40
5.6.4	Composite structures . . . . .	43
5.6.5	Level-width relationship . . . . .	43
5.6.6	Remarks and hints . . . . .	44
5.7	Results . . . . .	46
<b>6</b>	<b>Reference Manual . . . . .</b>	<b>49</b>
6.1	Bathymetry . . . . .	49
6.1.1	General description . . . . .	49
6.1.2	Selecting the model area . . . . .	49
6.1.3	Selecting the grid spacing . . . . .	51
6.1.4	Selecting the reference level . . . . .	54
6.1.5	Specifying the bathymetry . . . . .	54
6.1.6	Sign convention . . . . .	55
6.1.7	Additional area description . . . . .	55
6.2	Bed Resistance . . . . .	56
6.2.1	General description . . . . .	56
6.2.2	Specifying the bed resistance . . . . .	57
6.2.3	Recommended values . . . . .	57
6.2.4	Remarks and hints . . . . .	57
6.3	Blow-up . . . . .	58
6.4	Boundary Conditions . . . . .	58
6.4.1	General description . . . . .	58
6.4.2	Specifying the boundary conditions . . . . .	59
6.4.3	User specified boundaries . . . . .	61
6.4.4	Recommended selections and values . . . . .	63
6.4.5	Remarks and hints . . . . .	65
6.5	Chezy Number . . . . .	65
6.6	Courant Number . . . . .	66
6.6.1	General description . . . . .	66
6.6.2	Recommended value . . . . .	66
6.7	CPU Time . . . . .	66
6.7.1	Factors influencing the CPU time . . . . .	66
6.8	Current . . . . .	67
6.9	Disk Space . . . . .	67
6.9.1	Small files . . . . .	67
6.9.2	Large files . . . . .	68
6.9.3	Remarks and hints . . . . .	68
6.10	Evaporation . . . . .	68
6.11	Flooding and Drying . . . . .	69
6.11.1	General description . . . . .	69
6.11.2	Specifying flooding and drying . . . . .	69
6.11.3	Recommended values . . . . .	69
6.11.4	Remarks and hints . . . . .	70



6.12	Froude Number . . . . .	70
6.13	Hot Data . . . . .	70
	6.13.1 General description . . . . .	70
	6.13.2 Specifying the hot data . . . . .	71
6.14	Infiltration . . . . .	71
	6.14.1 General description . . . . .	71
	6.14.2 Net infiltration rate . . . . .	72
	6.14.3 Infiltration and leakage . . . . .	72
6.15	Initial Surface Elevation . . . . .	73
6.16	Inundation statistics . . . . .	73
6.17	Manning Number . . . . .	74
6.18	Multi-cell overland Solver . . . . .	74
	6.18.1 Constructing the fine and the coarse bathymetries . . . . .	74
	6.18.2 Evaluation of hydraulic parameters within a cell . . . . .	76
6.19	Orientation . . . . .	76
6.20	Output Files . . . . .	77
	6.20.1 General description . . . . .	77
	6.20.2 Specification of output files . . . . .	77
	6.20.3 Remarks and hints . . . . .	77
6.21	Pier Resistance . . . . .	78
	6.21.1 General description . . . . .	78
	6.21.2 Specifying the pier resistance . . . . .	79
6.22	Precipitation . . . . .	81
6.23	Simulation Type . . . . .	81
	6.23.1 General description . . . . .	81
	6.23.2 Remarks and hints . . . . .	82
6.24	Shear Stress . . . . .	82
6.25	Soft Start . . . . .	83
	6.25.1 General description . . . . .	83
	6.25.2 Specifying soft start . . . . .	83
	6.25.3 Remarks and hints . . . . .	83
6.26	Source and Sink . . . . .	83
	6.26.1 General description . . . . .	83
	6.26.2 Specifying sources and sinks . . . . .	84
	6.26.3 Remarks and hints . . . . .	84
6.27	Structures . . . . .	85
	6.27.1 Location of a structure . . . . .	85
	6.27.2 Weirs . . . . .	86
	6.27.3 Culverts . . . . .	89
	6.27.4 Dikes . . . . .	91
	6.27.5 Flow directions for specific structure parameters . . . . .	92
	6.27.6 Remarks and hints . . . . .	92
6.28	Time Step . . . . .	93
	6.28.1 Selecting the time step . . . . .	93
6.29	Velocity . . . . .	94
6.30	List of References . . . . .	95



Index .....	.97
-------------	-----





# 1 About This Guide

## 1.1 Purpose

The main purpose of this User Guide is to get you started in the use of MIKE 21 Flood Screening Tool (FST) for inland flooding applications.

This User Guide is complemented by the Online Help.

## 1.2 Assumed User Background

Although the hydrodynamic module has been designed carefully with emphasis on a logical and user-friendly interface, and although the User Guide and Online Help contains modelling procedures and a large amount of reference material, common sense is always needed in any practical application.

In this case, “common sense” means a background in inland flooding, which is sufficient for you to be able to check whether the results are reasonable or not. This User Guide is not intended as a substitute for a basic knowledge of the area in which you are working: mathematical modelling of hydraulic phenomena.





## 2 Introduction

### 2.1 General Description

MIKE 21 Flow Model is a modelling system for 2D free-surface flows. MIKE 21 Flow Model is applicable to the simulation of hydraulic and environmental phenomena in lakes, estuaries, bays, coastal areas and seas. It may be applied wherever stratification can be neglected.

MIKE 21 Flood Screening Tool (FST) provides a simple hydrodynamic solver for computations regarding inland flooding. MIKE 21 FST is based on MIKE 21 Flow Model, but uses simpler equations with some parameters from MIKE 21 Flow Model being excluded. Therefore, the parameters used in MIKE 21 FST are treated the same way as in MIKE 21 Flow Model.

The module simulates water level variations and flows in inland regions. The effects and facilities include:

- bottom shear stress
- sources and sinks
- evaporation
- flooding and drying

#### 2.1.1 Application Areas

MIKE 21 Flood Screening Tool is designed for inland flooding applications.





## 3 Examples

### 3.1 General

One of the best ways of learning how to use a modelling system like the MIKE 21 Flow Model is through practice. Therefore examples are included which you can go through yourself and which you can modify, if you like, in order to see what happens if one or other parameter is changed.

The specification files for the examples are included with the installation of MIKE Zero. A directory is provided for each example. The directory names are as follows (these may have been changed at your installation; please ask your system administrator if you cannot find the directories):

- Donegal Bay, Water circulation example:  
MIKE\_21\FST\DonegalBay
- Retention Basin by River, Structure example:  
MIKE\_21\FST\Structure

### 3.2 Donegal Bay

#### 3.2.1 Purpose

Previously, the water circulation in the northern part of Donegal bay has been investigated using the Hydrodynamic module of MIKE 21 Flow Model.

The same computations are now performed using the MIKE 21 Flood Screening Tool in order to compare the results with results from the MIKE 21 Flow Model.

#### 3.2.2 Defining the Model

The model setup is similar to that previously used for the MIKE 21 Flow Model.

The northern part of Donegal Bay including the River Eske estuary is shown in Figure 3.1. The currents are governed by the tide.

The model area was chosen based on the following considerations:

- The model is turned 50 degrees relative to true north so that the y-axis lies parallel to the flow in the main channel running from Donegal towards the bay. This rotation of the model also reduces the number of grid points in the model and makes the main flow direction at the boundary perpendicular to it.

- The boundary is situated not too close to the mouth of the estuary. This ensures a uniform flow pattern at the boundary. Furthermore, the boundary can not be situated in the mouth of the estuary itself, as flooding and drying are not allowed on an open boundary.



Figure 3.1 The northern part of Donegal Bay and the model area for the hydrodynamic model

A grid spacing of 150 meters was chosen as this was the maximum size, which could be used to define the tidal channels in the estuary.

The time step was chosen to be 60 seconds, as this results in a maximum Courant number of 5.9 in the deepest part of the model, and in Courant numbers of 2 to 3 in the estuary.

### 3.2.3 Setting Up the Model

The digitised model bathymetry is shown in Figure 3.2. Much effort was spent in its preparation especially in the estuary where all the channels had to be properly defined. The datum for the bathymetry is the lowest astronomical tide (LAT), which is 2.35 m below mean sea level (MSL).

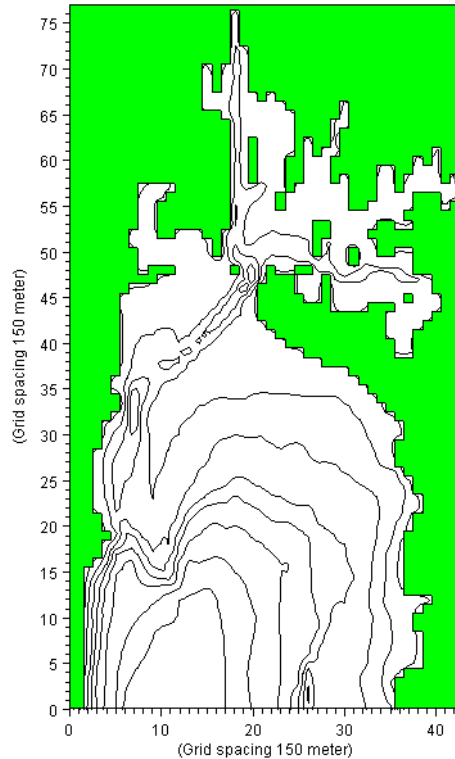

Figure 3.2 Model bathymetry, Donegal Bay

Simultaneous measurements of the water level close to the open boundary and near Donegal had been made for a period of a little more than one tidal cycle. This period was therefore selected as the calibration period. A tidal range of 2.5 meters with a period of 12.5 hours was measured at the boundary.

Other measurements showed that the spring tide range is 3.5 m and the neap tide range 1.5 m.

The discharge from the river is normally not very large. For the time of year when the calibration data were collected, a discharge of 7.15 m<sup>3</sup>/s is normal.

### 3.2.4 Results

Figure 3.3 shows the simulated water level variation during spring tide conditions in grid point (18,50) compared to the simulation results from a Flow Model .

The figure shows that even if there is small difference in output from the two different simulations, the results are comparative.

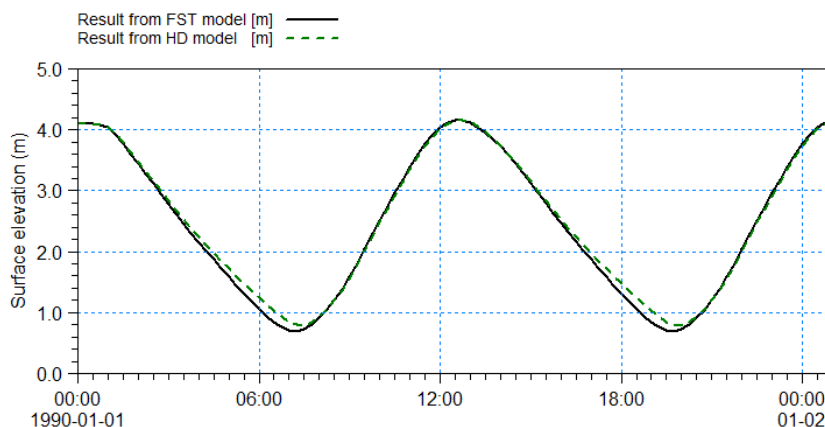

Figure 3.3 Surface elevation at the entry of the estuary during simulation

## 3.3 Retention Basin by River

### 3.3.1 Purpose of the Example

This example describe the flow between a river and a retention basin during a period of flooding using structures.

The same example exists for MIKE 21 Flow Model HD and the computations are now performed using the MIKE 21 Flood Screening Tool in order to compare the results with results from the MIKE 21 Flow Model.

The example is divided into four parts:

1. Discover the benefit of using a weir structure to simulate overflow
2. How to combine weir and culvert to simulate a flooding scenario
3. Effect of specifying a QH boundary type for downstream flow
4. Impact on flow due to dike failure

#### Part 1

The problem is to simulate the overflow of a river bank and subsequent filling of a retention basin. The test conditions are:

- The river section is 210 m long and 25 m wide. The river bed level is constant over the area at -4 m. The retention basin is 200 m long and 200 m wide with a uniform bed level at -2 m. Between the river and retention basin is a 5 m wide riverbank. The flow between the river and retention basin may take place along a 100 long section of the river bank, where the bathymetry level is +1 m.





- The natural flow conditions in the river correspond to an overall water surface gradient of 0.0001, corresponding to a difference in water level between the upstream boundary and the downstream boundary of 0.02 m, resulting in uni-directional flow.
- Initially the water level is -1 m in the river and the basin. Due to flooding the water level upstream and downstream then increase linearly to about +2 m during 3 hours whereafter the water level remains constant at the boundaries for the next 6 hours.

### Part 2

The problem is to simulate the filling and emptying of a retention basin.

- Using the same conditions as above the time frame is extended as the water level in the river decrease linearly from +2 m to -2 m during a 6 hour period followed by constant water level at the boundaries for the next 9 hours.
- The emptying of the retention basin is carried out using natural gravity through culverts with valves that allow for flow from the retention basin to the river but not vice versa. The culverts have a total cross-sectional area of 0.6 m<sup>2</sup>.

### Part 3

The problem is to simulate the filling and emptying of a retention basin when knowledge of the downstream boundary water level is missing.

- The downstream boundary is defined by a QH rating curve that contains an estimate of the relationship between the water level and discharge.
- The setup is otherwise to that of Part 2.

### Part 4

The problem is to simulate the flow into a retention basin that is subject to a dike failure occurrence. In order to compare the effect of a dike with the effect of a weir, the filling of the basin is first simulated without dike failure.

- The riverbank subject to failure is defined by a dike structure
- The setup is otherwise that of Part 1 when simulating a weir.

## 3.3.2 Defining the Hydrodynamic Model

The main condition defining the problem is:

- A grid with 48 x 42 grid points is applied with a grid spacing of 5 m. The grid is shown in Figure 3.4.

- A *time step* of 5 seconds is selected for simulation 1 and 2. A *time step* of 1 second is selected for simulation 3 and for simulation 4 a *time step* of 2.5 seconds is selected.  
The duration of simulation 1 is 9 hours (6480 time steps).  
The duration of simulation 2 is 24 hours (17280 time steps).  
The duration of simulation 3 is 24 hours (86400 time steps).  
The duration of simulation 4 is 6 hours (8640 time steps).
- Eddy viscosity is not considered in the Flood Screening Tool.
- The *bed resistance* type has been chosen to Manning number and a constant value of  $32 \text{ m}^{1/3}/\text{s}$  is applied.
- The water level in the river is described by a time series shown in Figure 3.5. The initial water level in both the river and the retention basin is -1 m.  
The downstream boundary for simulation 1, 2 and 4 is defined by a water level constantly 2 cm lower than the upstream boundary.  
The downstream boundary for simulation 3 is defined by a QH rating curve as shown in Figure 3.6.
- The length of *soft start interval* (warm-up period) has been chosen to 180 seconds.

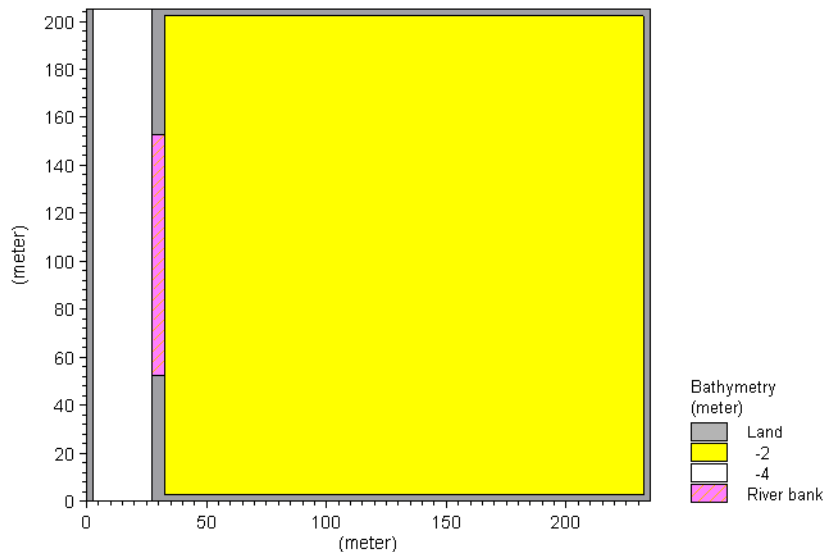

Figure 3.4 Filling of a retention basin, model layout.  $DX=5\text{m}$ .

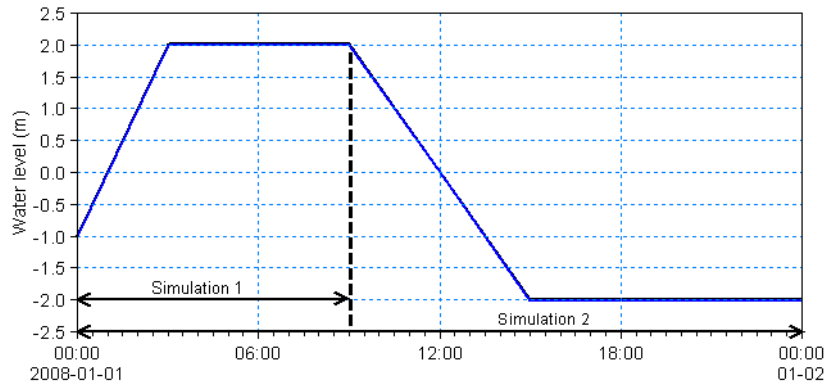

Figure 3.5 Water level in river section during simulations

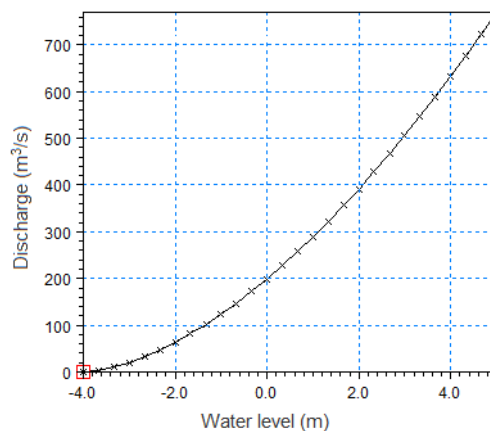

Figure 3.6 QH rating curve for simulation 3

### Part 1

To model the filling of the retention basin two different approaches are used:

- Defining the river bank by specifying the bathymetry level to -1 m.
- Defining the river bank as a broad crested weir with crest level +1 m on a bed level of -2 m. The weir is located along the line (31.0m, 52.5m) to (31.0m, 152.5m). The headloss factors are defined by default values.

### Part 2

To model the filling and following emptying of the retention basin the river bank is modelled by a composite structure.

- The river bank is defined as a broad crested weir with specifications as above.



- Three identical culverts are placed along the same line section as the weir. The culverts are defined as closed, circular culverts with a diameter of 0.5 m and positioned at an invert level of -1.5 m both upstream and downstream. The headloss factors are defined by default values. The culverts have valves that only allows for positive flow (out into the river).

### Part 3

To model the filling and following emptying of the retention basin the river bank is modelled by a composite structure similar to that described in Part 2.

### Part 4

To model the failure of the riverbank next to the retention basin the riverbank is defined by a dike structure with a space- and time varying crest level.

- The riverbank is defined by 4 (x,y) points as shown in Table 3.1.
- In the reference situation the dike is defined with a constant crest level of 1.0 m.
- The dike failure occurrence start at 01:45 and ends at 02:00. Figure 3.7 illustrates the temporal variation of the crest level during the duration of the failure.

Table 3.1 Location of points for crest level definition

Point	X-coordinate	Y-coordinate
1	31	52.5
2	31	102.5
3	31	132.5
4	31	152.5

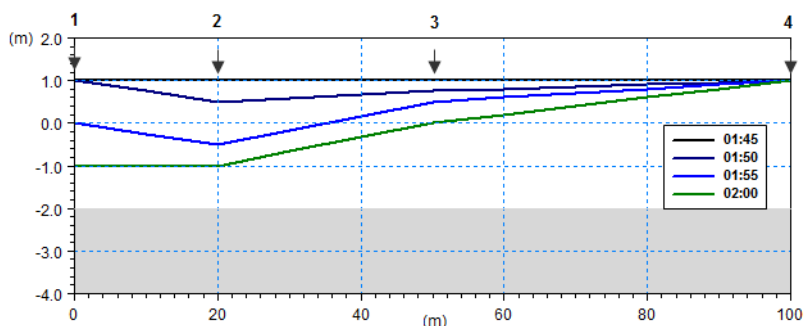

Figure 3.7 Crest level during failure occurrence. Integers indicate location points.



### 3.3.3 Presenting and Evaluating the Results

#### Part 1: Filling the retention basin

The filling of the basin was simulated using two approaches. Figure 3.8 and Figure 3.8 shows the surface elevation in position (100m, 100m) inside the basin along with the upstream water level in the river. Figure 3.8 shows the results when using modified bathymetry for riverbank and Figure 3.8 shows the result when using a weir structure for river bank.

Corresponding results from MIKE 21 Flow Model HD is shown for comparison.

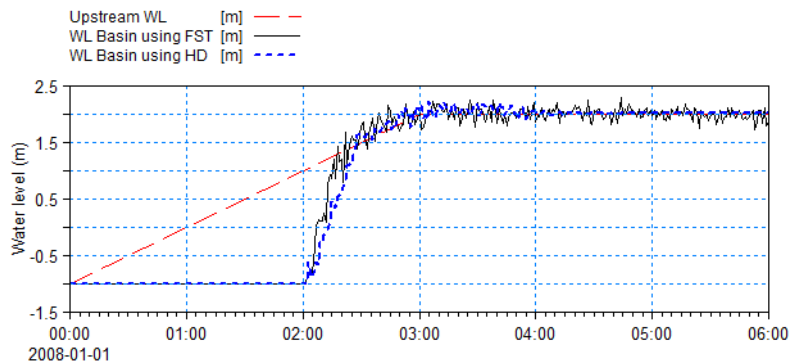

Figure 3.8 Water level inside basin when using modified bathymetry for river bank.  
Red stippled line: upstream water level in river for reference  
Black solid line: water level using Flood Screening Tool  
Blue dotted line: water level using Flow Model HD

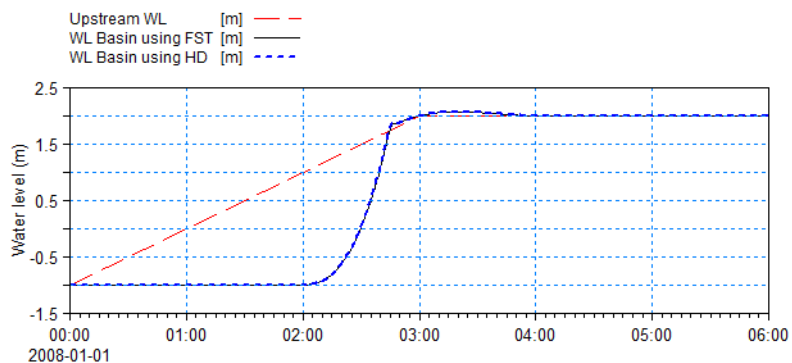

Figure 3.9 Water level inside basin when using weir structure for river bank.  
Red stippled line: upstream water level in river for reference  
Black solid line: water level using Flood Screening Tool  
Blue dotted line: water level using Flow Model HD

Figure 3.8 shows that modelling the river bank directly by the bathymetry level gives a more fluctuating water level using FST than when using HD. Figure 3.9 shows that modelling the river bank by a weir structure gives nearly the same result for the two different approaches.

### Part 2 Filling and emptying retention basin

Figure 3.10 shows the surface elevation in position (100m, 100m) inside the basin along with the upstream water level in the river.

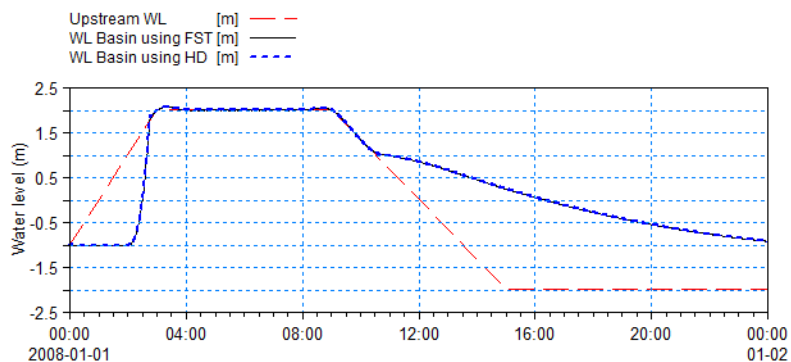

Figure 3.10 Water level inside basin when using weir and culverts  
 Red stippled line: upstream water level in river for reference  
 Black solid line: water level using Flood Screening Tool  
 Blue dotted line: water level using Flow Model HD

Figure 3.10 shows that the Flood Screening Tool and HD gives nearly the same result.

### Part 3 Using QH rating curve at downstream boundary

Figure 3.11 shows the surface elevation in position (100m,100m) in side the basin along with the upstream water level in the river.

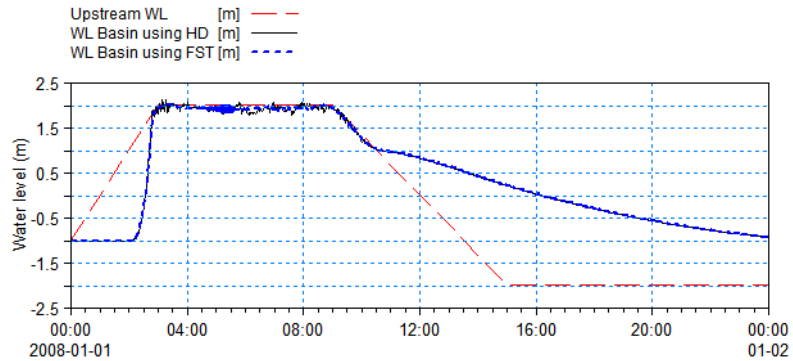

Figure 3.11 Water level inside basin when using QH curve  
 Red stippled line: upstream water level in river for reference  
 Black solid line: water level using Flood Screening Tool)  
 Blue dotted line: water level using Flow Model HD

Figure 3.11 shows that the Flood Screening Tool and HD gives nearly the same result. Note however that in order to avoid instabilities in this particular simulation the time step for the Flood Screening Tool needed to be smaller than the time step for the corresponding HD simulation.

#### Part 4: Impact of flow due to dike failure

Figure 3.12 shows the surface elevation in position (100m, 100m) inside the basin for the stable situation along with the upstream water level in the river.

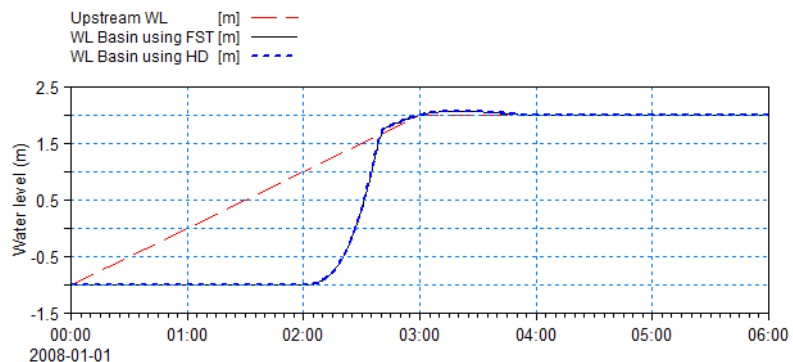

Figure 3.12 Resulting water level using dike with constant crest level  
 Red stippled line: upstream water level in river for reference  
 Black solid line: water level using Flood Screening Tool  
 Blue dotted line: water level using Flow Model HD

Figure 3.13 shows the surface elevation in position (100m, 100m) inside the basin for the situation with a time-varying crest level, representing a dike failure occurrence.



The figures shows that the Flood Screening Tool and HD gives nearly the same result. Note however that in order to avoid instabilities in the simulation with the time-varying crest level the time step for the Flood Screening Tool needed to be smaller than the time step for the corresponding HD simulation.

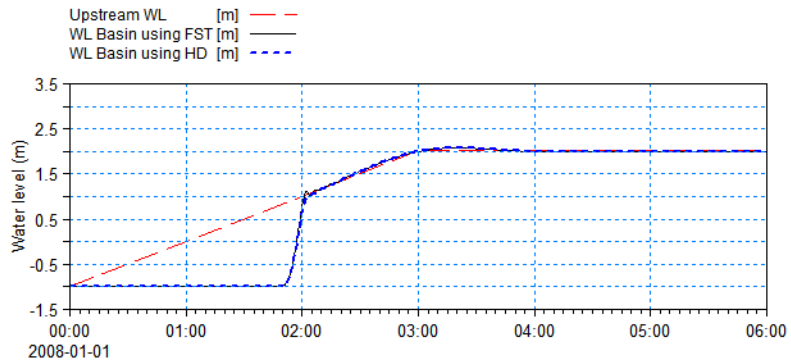

Figure 3.13 Resulting water level using during dike with time-varying crest level  
Red stippled line: upstream water level in river for reference  
Black solid line: water level using Flood Screening Tool  
Blue dotted line: water level using Flow Model HD





## 4 Basic Parameters Dialog Overview

In this section, you set up the basic parameters for your MIKE 21 Flow Model simulation. You need to specify parameters for

- Bathymetry
- Simulation Period
- Boundary
- Source and Sink
- Flood and Dry

Selections made here determine the structure of the rest of the model setup editor, i.e. the required entries for the hydrodynamic module and possible add-on modules. The tree-view and the number of available dialogues will expand according to the selections made for the basic parameters.

- 

### 4.1 Bathymetry

You can start a simulation in two different ways:

- as a Cold start
- as a Hot start

For modelling two-dimensional flow in rural and urban areas you can apply the Multi-cell overland solver.

Additional information describing the area you are about to simulate, obtained from the header information of the bathymetry/hot file, is:

- The geographical position of the grid origin (main area).  
If you are on the southern hemisphere, you should use a negative value for the latitude.
- The grid orientation is measured clockwise from true north to the y-axis of your grid.
- The projection zone (e.g. UTM-32) should be specified.
- True land value is the minimum value you have specified for land points when you prepared the bathymetry.

An example with a step-by-step description of how to use the Bathymetry Editor for creating a bathymetry data file is included with the installation. Please find this example in your installation folder under Examples\MIKEZero\BatEdit.

See also Additional area description (*p. 55*).



### 4.1.1 Cold start

For a cold start the velocity field is initialized to zero. When choosing this option you have to specify a type 2 data file, containing the area bathymetry.



### 4.1.2 Hot start

The hot start facility requires a hot file. This file must originate from a previous simulation. The hot start file contain all necessary information to continue a simulation. In this way simulation time can be reduced if for instance a number of scenarios are to be compared, all based on the same (hot start) initial conditions.

### 4.1.3 Multi-cell overland solver

The MIKE 21 multi-cell overland solver is designed for simulating two-dimensional flow in rural and urban areas. The overall idea behind the solver is to solve the modified equations on a coarse grid taking the variation of the bathymetry within each grid cell into account. Results are presented on the grid that takes the fine scale bathymetry into account. When using the multi-cell overland solver the HD result files will also inherit the geographical information from the fine scale bathymetry.

Please note that even though results are presented on the fine scale, the numerical simulations are carried out on a higher scale. The inundation is calculated based on a depth varying flooded area.

To run the multi-cell overland solver the solver  be selected (see Figure 4.1) along with the fine bathymetry file (in dfs2 format).  that only valid dsf2 files may be selected. If the overland solver has  selected the Coriolis forcing will be deactivated along with the land slide option.

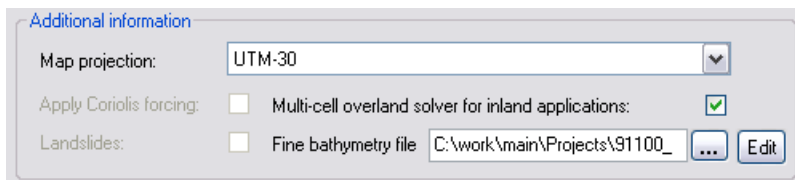

Figure 4.1 The selection of the multi-cell overland solver

See also Multi-cell overland Solver (p. 74).

## 4.2 Simulation Period

In this dialog you must specify simulation period information:



- Time step range is the number of time steps the simulation should cover.
- The time step interval is the amount time is incremented between each time step (equal for all areas). In case of a hot-started simulation, the time step is taken from the hot file and cannot be changed.
- The simulation start date is the historical date and time corresponding to time step zero. In case of a hot-started simulation, the simulation start date is read from the hot file and cannot be changed.
- The warm-up period is a number of time steps over which the forcing functions are gradually increased from zero to 100% of their true value.

Before you leave this dialog, the system will calculate and show the maximum Courant Number (*p. 66*) in the model. The calculation assumes a constant mean water level of 0.0. You should consider reducing the time step if this Courant number exceeds (say) 8 to 10.

For your information, and as a possible check on parameter specifications, the simulation end date (and hour) is calculated and shown in the dialog.

## 4.3 Boundary

The MIKE 21 Flow Model requires you to specify either the surface elevation or the flux at **all** open boundary points.

When a bathymetry or a 'hot start' file for the main area has been specified under 'Bathymetry' it is scanned for locating the open boundaries, i.e. they are "program detected".

In most cases these boundary positions can be used "as is"; but in some cases the user might want to define the positions himself. This may be due to borders (internal boundaries), a boundary stretching over a series of small islands, etc.

For such "user specified" boundaries, you have to specify the number of open boundaries as well as their locations in terms of first and last (end) points. A maximum of 8 open boundaries is allowed.

## 4.4 Source and Sink

The model distinguishes between three different kinds of sources/sinks:

1. Isolated source; a point where a certain amount of water is discharged into the model, with a certain velocity. Both the continuity and momentum equations are affected.
2. Isolated sink; a point where water is discharged from the model. Only the continuity equation is affected.



3. Connected source and sink pair; used for e.g. AD recirculation studies. The amount of water removed at the sink point is reentered at the source point, with a specified velocity.

You may select up to 1024 sources and sinks. However only 512 can be defined by time series files.

The source and sink positions are specified by their horizontal grid coordinates, in their respective model area. The model area so specified should be the one with the finest grid resolution covering the geographical position of the source/sink.

Do not place the sources/sinks on land, and be careful when placing sources/sinks at locations that may occasionally dry out.

## 4.5 Flood and Dry

The flooding and drying facility incurs a certain computational overhead but is necessary to obtain accurate results.

You can set the minimum water depth allowed in a point before it is taken out of calculation (drying depth), and also the water depth at which the point will be reentered into the calculation (flooding depth).



## 5 Dialog Overview

### 5.1 Initial Surface Elevation

Having selected a cold start simulation under Bathymetry (p. 25), you must also provide information about the initial (water) surface level. The initial surface elevation for each area can be specified in two ways:

- as a constant value for the respective area, or
- to be read from a dfs2 data file (with one time step only).

Often the initial surface level can be set to a constant value to be applied over the whole model area. This means that the simulation will start out with the surface level raised accordingly.

You should specify values that agree with your boundary conditions, i.e. if you start a simulation at high water with a boundary value of 0.5 m you should also specify the initial surface elevation to 0.5 m.

For hot-starts, all initial conditions - including the surface elevations - are read from the hot-file.

### 5.2 Boundary

The MIKE 21 hydrodynamic model requires you to specify either the surface elevation or flux at all open boundary points specified on Boundary (p. 27).

The choice of variation at an open boundary can be either level or flux (the flux is the total amount of discharge passing the open boundary). Actual values, level or flux, at each boundary can be specified in one of five different formats:

- Constant value
- Sine series
- Time series
- Line series
- Transfer data
- Rating curve

#### Constant value

In the first case, you specify the constant value (constant both in space and time) to be applied along the whole boundary.



### Sine series

For sinusoidal variation, you must specify the reference level, range, period and phase of the sine series.

### Time series

When selecting time series boundary variation, you must specify the name of a type 0 data file. The temporal variation given in this file is applied along the whole boundary.

### Line series

For line series, the temporal variation along the boundary is obtained from the specified type 1 data file.

### Transfer data

In the case of transfer data, boundary values are obtained from the results of another simulation, i.e. from a transfer data file generated by the “Transfer boundary tool”, M21trn, in the MIKE 21 Toolbox.

### Rating curve

In the case of Rating curve you must specify a dfs0 time series representing the relation between discharge and water level (specified by the relative axis). The discharge values in the rating curve should be supplied as non-negative values. MIKE 21 Flow Model will during the processing make sure that the discharge in the QH relation will be effectuated as an outflow at the boundary. The use of Rating curve is only recommended for downstream boundaries where water flows out of the model.

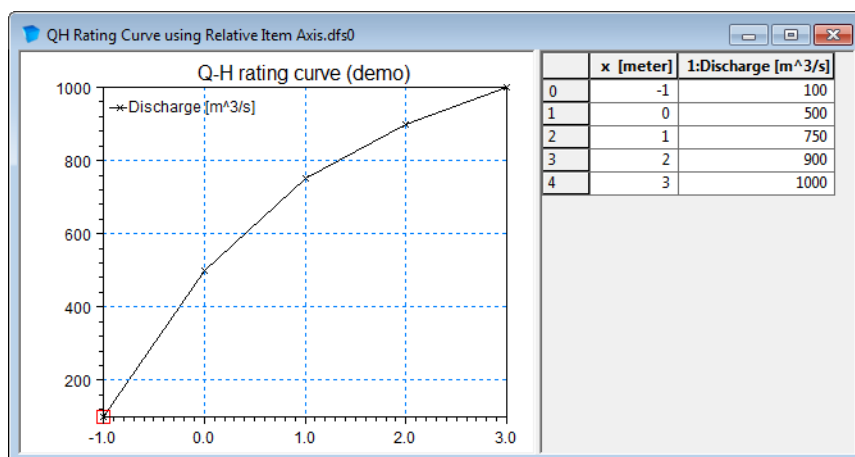

Figure 5.1 Example of Rating curve

### FAB type

The FAB type selects the strategy for calculating the fluxes along the open boundary. See the manual for a description and discussion of available options.



### Tilting

Tilting of a boundary is a facility that generates a setup along the open boundary so that the slope of the surface elevation is in equilibrium with the wind stress and Coriolis force. It should only be applied if the flux along the boundary is negligible. You may select “linear tilting” or “non-linear tilting” and set the tilt point. In the linear approach the bed slope is assumed to be constant whereas in the non-linear approach the actual water depth is taken into consideration. The linear approach results in a more stable solution, the non-linear is more precise, but over a jagged bed spurious fluctuations may occur. With respect to the tilting point, it is a good first guess to select the deepest point along the boundary. However, trial and error in some cases is a way to obtain the best results.

### Flow direction

Default flow directions are perpendicular to the open boundary. In those situations where this can not be assumed, the possibility exists for specifying the directions. See Boundary Conditions (p. 58).

## 5.3 Source and Sink

For each source

- the discharge magnitude,
- the speed and
- the outlet direction

by which the water is discharged into the ambient water must be specified while for each sink only

- the intake magnitude

is specified since sinks do not contribute to the momentum equation, only to the mass equation. For a connected source-sink pairs, the discharge magnitude at the source equals the intake magnitude at the sink. Source/sink magnitudes (in  $\text{m}^3/\text{s}$ ) and source speed (in  $\text{m}/\text{s}$ ) can either be given in a type 0 file (time series) or as constant values. The outlet direction is the horizontal direction relative to true North and should be specified as a constant.

### 5.3.1 Evaporation and precipitation

On the Source and Sink (HD) dialog you also specify Evaporation and Precipitation rates (in  $\text{mm}/\text{day}$ ). These can be given as constant values, from type 0 data files or from type 2 data files (covering the main area only).

When precipitation or evaporation data are provided in a type 0 data file, values are always considered as instantaneous values. The TS-type specified in



this data file for the precipitation and evaporation data should therefore be Instantaneous.

## Precipitation on dry land

The default numerical scheme in MIKE 21 Flow Model, HD handles evaporation and rainfall/precipitation only at wet computational cells. To activate calculations in dried cells (for the whole model domain) you need to enable 'Precipitation on dry land'.  that when including rainfall, the user assumes 100% runoff, which may or may not be appropriate if significant infiltration and storage can occur in the soil or ground material.

## 5.4 Infiltration

The effect of infiltration and leakage at the surface zone may be important in cases of flooding scenarios on otherwise dry land.

You may include the effect of infiltration in two different ways:

- Net infiltration
- Constant infiltration with capacity.

### 5.4.1 Net infiltration

The net infiltration rate can be specified in one of three ways:

- Constant (a constant value applied over the whole area)
- Constant in time, varying in space (a type 2 data file covering the whole area)
- Varying in time and space (a type 2 data file covering the whole area and whole simulation period)



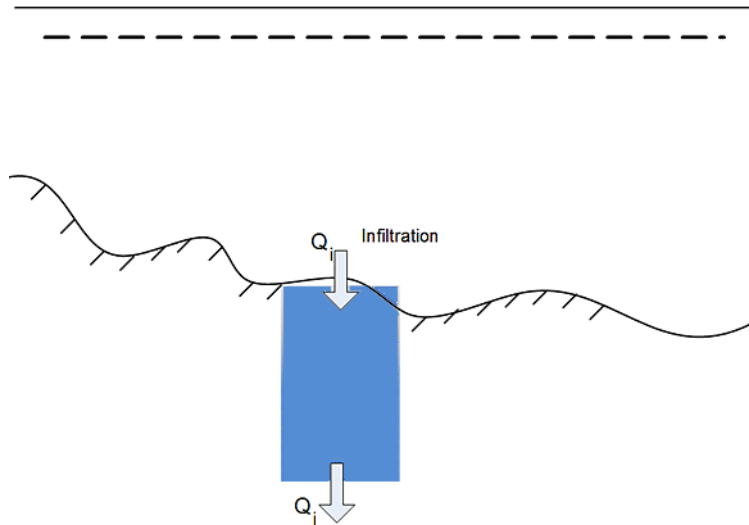

Figure 5.2 Definition of net infiltration rate

See also Net infiltration rate (p. 72).

#### 5.4.2 Constant infiltration with capacity

For this description you first have to define the type of two parameters that are contained in the input type 2 data file:

- The extent of the infiltration zone must be defined by Depth or Level.
- The initial water volume in the infiltration zone must be defined by Percentage of the Capacity (interval: 0-100 [%]) or the Water Content (interval: 0-porosity [()]).

A type 2 data file (Constant in time, Varying in space) with 5 items must be specified:

1. Infiltration rate
2. Porosity of infiltration zone
3. Depth OR Level value describing the extent of the infiltration zone
4. Leakage rate (specified as type infiltration)
5. Initial water volume in Percentage of capacity OR as Water Content

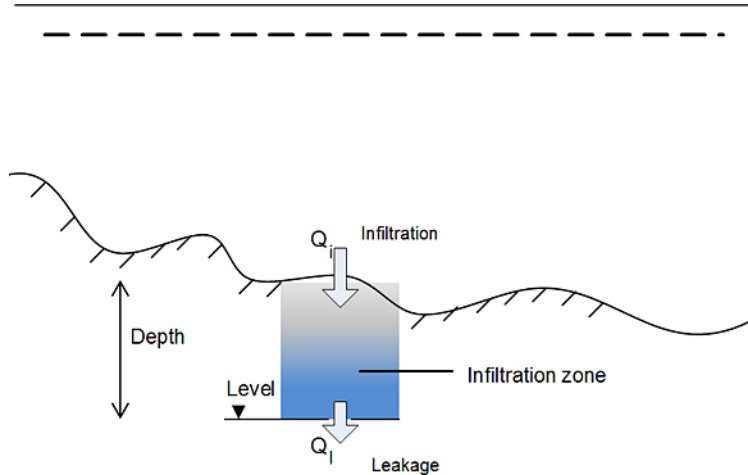

Figure 5.3 Definition of infiltration with storage and leakage

See also Infiltration and leakage (p. 72).

## 5.5 Resistance

The resistance type is defined as one of two types:

- Manning number
- Chezy number

If the bottom friction is described by Manning or Chezy number, the values can be specified in one of two ways:

- as a constant value applied over the whole area
- as a type 2 data file where each grid point has its defined friction value

Manning numbers are converted to Chezy numbers on the basis of the calculated water depth. You must specify the constant value or the file name of the type 2 data for each area.

See also Bed Resistance (p. 56).

Pier resistance can be used to model the effect of pillars or piers on the flow field. The pier position and its geometrical layout should be defined in a type 1 data file. See Pier Resistance (p. 78) in the reference manual for a description of such a pier file.

## 5.6 Structures

The structures in MIKE 21 are implemented as one-dimensional structures thus the flow across a structure is calculated as a discharge for the whole



structure. This discharge is distributed uniformly across the affected cell faces.

Three types of Hydraulic Structures are presently available. These are:

- Weirs
- Culverts
- Dikes

Furthermore you have the option to include Composite structures by combining two or more defined structures.

You can also include a pier structure, see Resistance (p. 34).

### 5.6.1 Weirs

Weir data are defined in two grid tables in the present page: Upper Input data grid and Lower Input data grid.

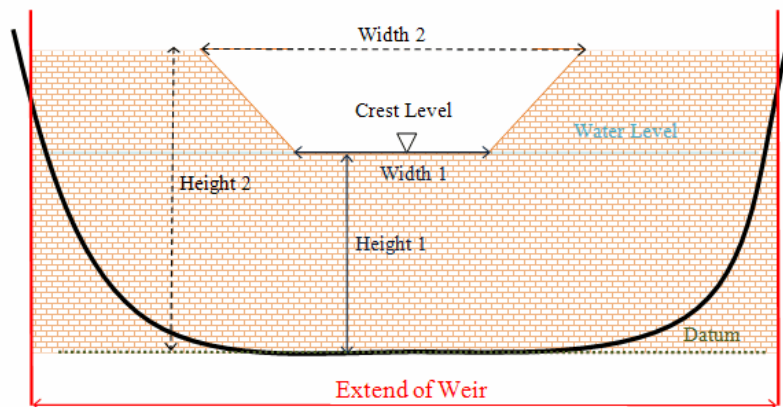



Figure 5.4 Setup definitions of contracted weir

#### Upper Input data grid

The number of weirs must be defined initially. This number defines the number of structure definition lines which will be present for defining weir input data.

##### Name

The Name of weir is a user defined ID-string for each weir.  **Note:** Names must not be identical for different structures included in del simulations.

##### Location

'Location' and 'Projection' columns define the actual location of the weir.



Weirs are defined in the model area as a cross section specified as a list of points (a minimum of two points required), through which the structure flow occurs. The weir section is composed of a sequence of straight line segments between successive points, where the geographical coordinates are defined in the 'point selection' dialog which opens when pressing the  button in the 'Location' column. You must also select the map projection (Longitude/Latitude, UTM etc.) in which the specified location coordinates for the weir are defined.

See also Location of a structure (p. 85).

### Type

The weir-formula to be applied is selected from the drop down selection list in the 'Type' column. A range of formulas are available:

- Broad crested weir formula
- Weir formula 1
- Weir formula 2 (Honma formula)

### Valve

Valve regulation of the structure flow can be defined as part of the weir definition. Four different valve regulation types are available:

- None: No valve regulation applies (flow is not regulated).
- Only Positive Flow  
Only flow in positive flow direction is allowed. Valve regulation does not allow flow in negative flow direction and the flow through the structure will be zero in this case.
- Only Negative Flow  
Only flow in negative flow direction is allowed. Valve regulation does not allow flow in positive flow direction and the flow through the structure will be zero in this case.
- No Flow  
No flow is allowed in the structure. Valve regulation closes completely the structure.

### Alpha zero

When the water level gradient across a structure is small the corresponding gradient of the discharge with respect to the water levels is large. This in turn may result in a very rapid flow response to minor changes in the water level upstream and downstream. As a way of controlling this effect a Alpha Zero factor has been introduced. The Alpha Zero factor defines the water level difference below which the discharge gradients are suppressed. The default setting is 0.01 meter. If a structure shows oscillatory behaviour it is recommended to increase this value slightly.



### Head loss factors

The Loss Factors determines the energy (Head) loss of the flow over the weir. These are defined in the last six columns. Each loss factor is defined by a suffix, where '+' indicates Positive Flow direction and; suffix '-' indicates Negative Flow direction.(e.g. 'Inflow -' means inflow loss coefficient for negative flow direction).

Three types of Loss factors are present for both positive and negative flow direction:

- Inflow (contraction loss)
- Outflow (expansion loss)
- Free flow

Head Loss Factors are applied in structure flow calculation only for the broad crested weir type. See also Head Loss Factors (p. 88).

### Lower Input data grid

The lower input data grid contains the geometry definition for the broad crested weir type or alternatively values of weir formula parameters if one of the weir formulas have been selected.

For the Broad crested weir formula the geometrical shape of the active flow area must be defined by a Level-width relationship table. The levels are defined relative to the datum (starting from the crest or sill level and up). E.g. for a horizontal weir positioned at invert level -10m (bed level) and extending 6 m above the bed, the weir could should be defined by  $L_0 = -4\text{m}$  and  $L_1 = 0\text{m}$ . Datum defines an offset which is added to the level column in the level/width table during computation.

Pressing the  button in the 'Geometry' column opens a Level-Width dialog where the geometry relation can be entered. '

For Weir formula 1 and Weir formula 2 the geometry of the structure itself must be defined. From this the active flow area will be calculated automatically in the simulation. Values for the respective weir formula parameters must be defined in the respective columns.

See also Weirs (p. 86).

## 5.6.2 Culverts

Culvert data are defined in two grid tables in the present page:  
Upper Input data grid and Lower Input data grid.

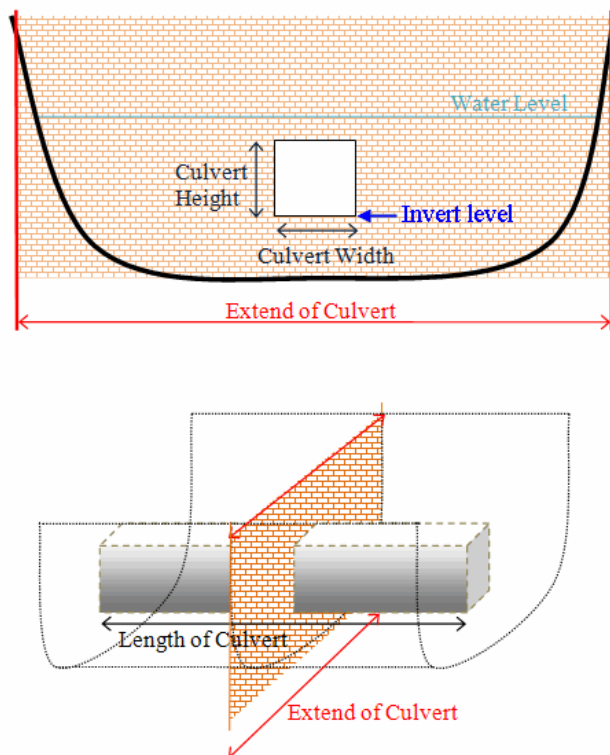



Figure 5.5 Setup definitions of culvert

## Upper Input data grid

The number of culverts must be defined initially. This number defines the number of structure definition lines which will be present for defining culvert input data.

### Name

The Name of culvert is a user defined ID-string for each culvert.  **Note:** Names must not be identical for different structures included in del simulations.

### Location

'Location' and 'Projection' columns define the actual location of the culvert.

Culverts are defined in the model area as a cross section specified as a list of points (a minimum of two points required) through which the structure flow occurs. The culvert section is composed of a sequence of straight line segments between successive points, where the geographical coordinates are defined in the 'point selection' dialog which opens when pressing the  button in the 'Location' column. You must also select the map projection (Longitude/Latitude, UTM, etc.) in which the specified location coordinates for the culvert are defined.



See also Location of a structure (p. 85).

### Valve

Valve regulation of the structure flow can be defined as part of the culvert definition. Four different valve regulation types are available:

- None: No valve regulation applies (flow is not regulated).
- Only Positive Flow  
Only flow in positive flow direction is allowed. Valve regulation does not allow flow in negative flow direction and the flow through the structure will be zero in this case.
- Only Negative Flow  
Only flow in negative flow direction is allowed. Valve regulation does not allow flow in positive flow direction and the flow through the structure will be zero in this case.
- No Flow  
No flow is allowed in the structure. Valve regulation closes completely the structure.

### Head loss factors

The Loss Factors determines the energy (Head) loss over the culvert. These are defined in the last eight columns. Each loss factor is defined by a suffix, where '+' indicates Positive Flow direction and; suffix '-' indicates Negative Flow direction.(e.g. 'Inflow -' means inflow loss coefficient for negative flow direction).

Four types of Loss factors are defined for both positive and negative flow directions:

- Inflow (contraction loss)
- Outflow (expansion loss)
- Free flow
- Bends

### Lower Input data grid

The lower input data grid contains the physical description of the culvert (geometry, invert levels, length etc.).

A culvert can be defined as one of three Geometry types:

- Rectangular (requires definition of culvert Width and Height)
- Circular (requires definition of culvert (internal) Diameter)



- Irregular (Level-Width relation)  
In case of an Irregular shape culvert, the geometry must be defined by a Level-width relationship table.  
Pressing the  button in the 'Geometry' column opens a Level-Width dialog where the geometry relation can be entered.

The culvert geometry defines the geometrical shape of the active flow area of the culvert.

In the 'Section Type' column it can be defined whether a culvert structure is a Closed or an Open section type.

In the last five columns, a number of parameters defines specific culvert characteristics:

- 'Upstream Invert' is the Invert level at inflow location of the culvert.
- 'Downstr. Invert' is the Invert level at outflow location of the culvert.
- 'Length' is the length of the culvert.
- 'Manning's n' is the Manning's bed resistance number along the inside of the culvert (for friction loss contribution).
- 'No. of Culverts' is a number identifying how many culverts exist at the specific culvert location with identical geometrical definition.  
An example; Five identical shaped draining pipes are placed just next to each other in an earth dam, and in order not to make 5 individual definitions (5 lines) in the culvert page - one for each pipe - the 'No. of Culverts' in this case can be defined as 5 and the simulation engine will recognize that 5 culverts of identical shape and size are located here and flow calculations will take this into account accordingly.

See also Culverts (*p.* 89).

### 5.6.3 Dikes

The dike data are defined in two grid tables in the present page:  
Upper input data grid and Lower input data grid.



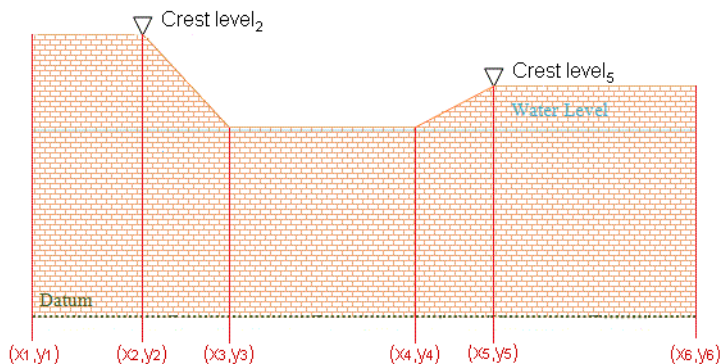



Figure 5.6 Example of dike defined by 6 geo-referenced points

## Upper input data grid

The number of dikes must be defined initially. This number defines the number of structure definition lines which will be present for defining the dike input data.

### Name

The Name of dike is a user defined ID-string for each dike.  **Note:** Names must not be identical for different structures included in del simulations.

### Include

It is possible to include or exclude defined dikes from the simulation.

### Location

'Location' and 'Projection' columns define the actual location of the dike.

The location in the horizontal domain of a dike is given by a number of geo-referenced points which together make up a polyline. The geographical coordinates are defined in the Lower input data grid shown when pressing the  button in the 'Location' column. You must also select the map projection (Longitude/Latitude, UTM etc.) in which the specified location coordinates for the dike are defined.

See also Location of a structure (*p. 85*).

### Discharge coefficient

For a description of the discharge coefficient see Dikes (*p. 91*).

### Delta level

When the water level gradient across a structure is small, the corresponding gradient of the discharge with respect to the water levels is large. This in turn may result in a very rapid flow response to minor changes in the water level upstream and downstream.



As a way of controlling this effect, a critical level difference has been introduced. The critical water level difference defines the water level difference below which the discharge gradients are suppressed. The default setting is 0.01 meter. If a structure shows oscillatory behaviour it is recommended to increase this value slightly.

### Crest level information

The crest level of the dike can be specified as

- Constant
- Varying in space
- Varying in space and time

When Constant is specified you have to specify the constant crest level. In case the crest level is varying you have to specify the crest level data in the Lower input data grid for the defined grid points.

## Lower input data grid

### Location

The location in the horizontal domain of a dike is given by a number of geo-referenced points which together make up a polyline. The poly-line defines the width of the dike perpendicular to the flow direction. A minimum of two points is required. The polyline is composed of a sequence of line segments. The line segments are straight lines between two successive points. The polyline (cross section) in the numerical calculations is defined as a section of element faces. The face is included in the section when the line between the two element centres of the faces crosses one of the line segments.

The geo-referenced points defining the dike can be specified directly in the dialog or imported from an ASCII file. The file format is three space separated floats (real numbers) for x and y-coordinate and the crest level on separate lines for each of the points.



**Note:** The faces defining the line section for the dike will be listed in the dialog.

### Crest level

The crest level of a dike can be specified as:

- Constant
- Varying in space
- Varying in space and time

When the crest level is specified as constant the crest level is defined by the value specified in the Upper input data grid.

When the crest level is specified as varying in space the crest level is defined by the values in the Lower input data grid.



When the crest level is specified as varying in space and time you have to prepare a data file containing the crest level before you set up the simulation. The file must be a dfs1 file, where the number of grid points corresponds to the number of points, which is used to define the location of the dike. The data must cover the complete simulation period. The time step of the input data file does not, however, have to be the same as the time step of the hydrodynamic simulation. A linear interpolation will be applied if the time steps differ.

#### 5.6.4 Composite structures

Composite structures can be defined by combining two or more defined structures. A composite structure can be composed of a combination of Weirs and/or Culverts.

An example of a composite structure could be a bridge with multiple waterways. Such a structure can be described by a number of culverts, each defining an individual waterway. Additionally, for a potential bridge deck overtopping a weir can be included to describe such overflow.

A set of structures forming a composite structure are recognized by the program from the location definitions. Locations must be completely identical for all the structures forming the composite structure. That is, the table of coordinates defining the structure locations must be exactly identical (number of coordinates and coordinate values) for all structures defined.

#### 5.6.5 Level-width relationship

The geometry of a structure may be defined by a level-width relation, where the Level/Width table defines the shape of the active flow area as a set of corresponding levels and flow widths. Values in the levels column must be continuous, increasing values.

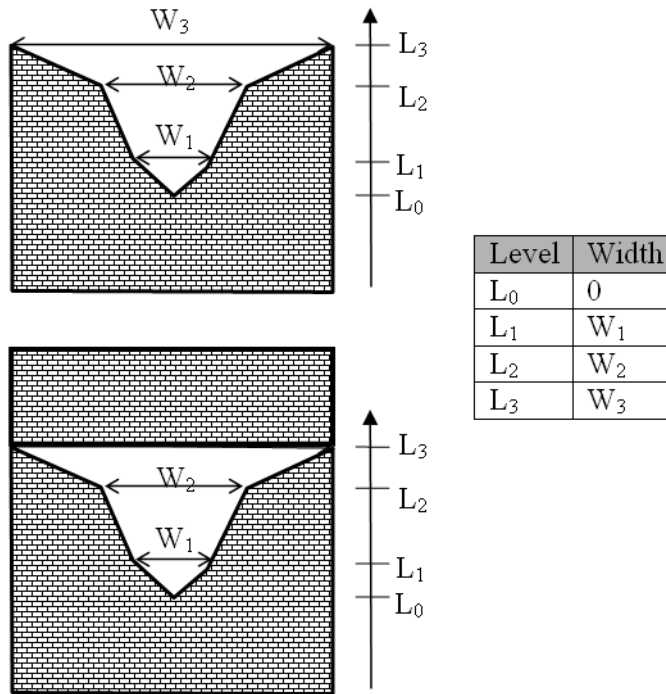

Figure 5.7 Definition sketch of level-width relationship  
 Upper: broad crested weir  
 Lower: Irregular culvert

### 5.6.6 Remarks and hints

The implementation of structures in MIKE 21 allows multiple structures at the same location. Thus it is possible to introduce multiple culverts at the same location or say a weir and a culvert at the same location. Each structure is simply defined separately in the interface and the combined flow is handled by the calculation kernel. Examples are given below.

#### A wide weir with a small opening

Consider a weir as illustrated in Figure 5.8.

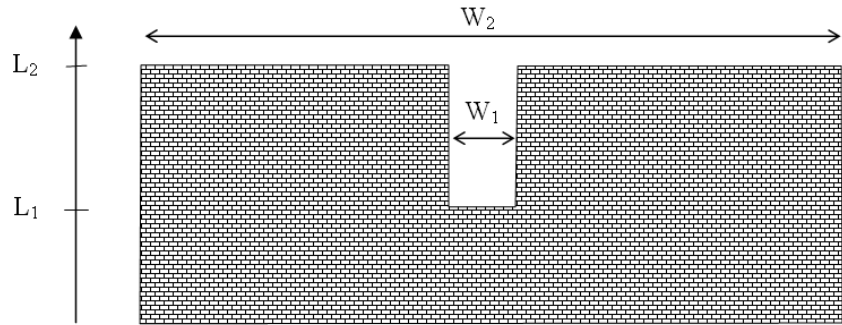

Figure 5.8 Wide weir with a small opening

There are a number of possibilities when modelling this in MIKE 21:

1. One weir
2. Two weirs with width  $W_1$  and width  $(W_2 - W_1)$ , respectively
3. Three weirs with widths  $W_1$  and two with width  $(W_2 - W_1)/2$ , respectively

Using the first approach is only appropriate if the weir can be contained within a single grid cell. The second approach may be used if the weir spans multiple cells, keeping in mind that the flow over the highest crest ( $L_2$ ) is uniformly distributed over all the affected cells. The third approach will give the best representation of the flow. Note that the location needs to be defined for each of the segments for case 2 and 3.

### A wide weir with multiple culverts

Consider a structure as illustrated below

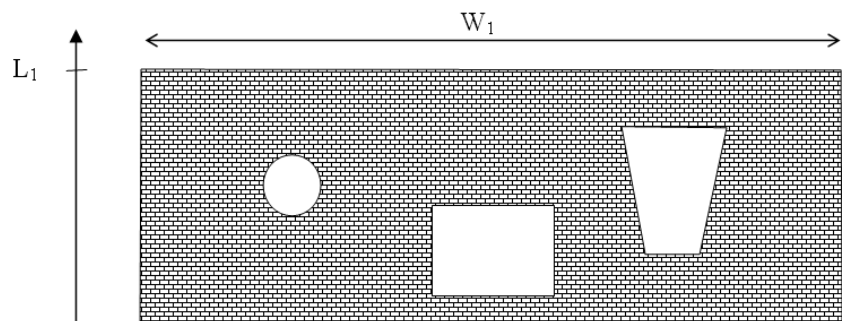

Figure 5.9 Wide weir with multiple culverts

The composite structure should be implemented as four separate structures:



1. A weir with a constant crest level L1 and a location defined by the full extent of the weir
2. A circular culvert
3. A rectangular culvert
4. A irregular culvert described by a level/width table



**Note** that the location needs to be defined for each of the four structure components separately. The location line should correspond to the maximum width of the structure component while still obeying the minimum requirement with respect to intersecting a line segments connecting cell centres.

## 5.7 Results

Two main types of output data can be obtained from a hydrodynamic simulation:

1. 'Output file', a type 0 (point series), 1 (line series) or 2 (area series) data file, which contains results from the hydrodynamic simulation. Because the amount of model output tends to be very large - huge - it is often not feasible to save all output items in all computational areas and in all grid points at all time steps. In order to reduce the file size it is possible to specify the output file using sub-areas and sub-sets for selected items.

See also Specification of output files (*p.* 77)

2. 'Hot start file', a type 2 data file, which can be used to re-start computations. You have to specify the name of the hot-output file. You can specify a title too, if you want.

In addition Inundation statistics can be calculated and stored as a dfs2 file. The update frequency is given in the form of a time interval. The update frequency only has an effect on how often the results are written to the file. If the simulation runs to completion then the update frequency may be chosen large so that disc access is reduced. To only update the inundation statistics at the end of the simulation set the update frequency ( $f_{update}$ ) to the total duration of the simulation, i.e.

$$f_{update} = N \cdot \Delta t \quad (5.1)$$

where  $N$  is the total number of time steps and  $\Delta t$  is the time step interval.

It is possible to add the duration in which the water depth is above a user-specified threshold during the simulation to the inundation statistics output.



**Note:** If the dfs2 file contains 'level and flux' output only and has a Data type = 1 (set automatically during output if only H, P and Q are selected), then it is possible to use derived items from the file in other MIKE Zero components such as Plot Composer, Result Viewer and the MIKE Zero Toolbox statistics.







## 6 Reference Manual

### 6.1 Bathymetry

#### 6.1.1 General description

Describing the water depths in your model area for the hydrodynamic model is without doubt the **most important task** in the modelling process. A few hours less spent in setting up the model bathymetry might later on mean extra days spent in the calibration process.

Giving exhaustive guidelines for how you should specify the bathymetry in order to avoid any problems later on is, however, nearly impossible. You can avoid many problems in the modelling process by adhering to the directions given below, but the experience you build up through practise is valuable.

An example with a step-by-step description of how to use the Bathymetry Editor for creating a bathymetry data file is included with the installation. Please find this example in your installation folder under Examples\MIKEZero\BatEdit.

#### 6.1.2 Selecting the model area

When deciding on which area to include in your model and thus where you should place your open boundaries you should take the following into consideration:

- The MIKE 21 Flow Model is a finite difference model with constant grid spacings in the x- and y-direction, and therefore your model area has to be rectangular. It also means that the computational points will lie in a square or rectangular grid.
- Your area or point of interest should lie well inside the model area, say at least 10 grid points from the boundary but preferably more.
- You may have to include not only the area immediately surrounding the area or point of interest but a much larger one in order to have, for example, the wind surge computed properly.
- You should have your open boundaries in areas where the water flow is “well behaved” and the flow direction, if possible, perpendicular to the open boundary.
- A “well behaved” flow in this connection means that, since certain assumptions are made in the computations at the boundaries, the flow pattern should be smooth at the boundary and in the area inside the boundary (that is 5 to 10 grid points inside the boundary). In other words, the bathymetry should be smooth close to all open boundaries.

- You will not always be able to situate all open boundaries so that the flow runs perpendicular to the boundary line. In those cases, you will have to specify the flow direction yourself. However, try to have the flow as close to being perpendicular as possible.
- As you must know either the water level variation or the magnitude of the flow at the open boundaries, you have to place the boundaries through points or between points, where such data are known. If, for example, you are going to do a tidal simulation, the open boundaries can be placed such that there is a tidal station at each end of the open boundary.
- Open boundaries can meet in corners, but you have to include the corner point in both open boundaries. You must then ensure that the boundary conditions in the corner point are the same when seen from both open boundaries. This requires that you have good level or flux data at the boundary. If not, the corner should be placed on a not too small island (see Figure 6.1).

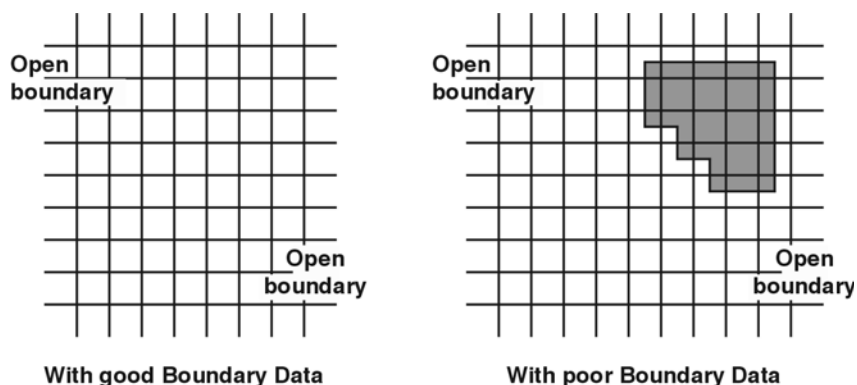

Figure 6.1 Two open boundaries in a corner

- Avoid sudden expansions or contractions of the flow close to an open boundary unless the current speeds are small (see Figure 6.2 and Figure 6.3).

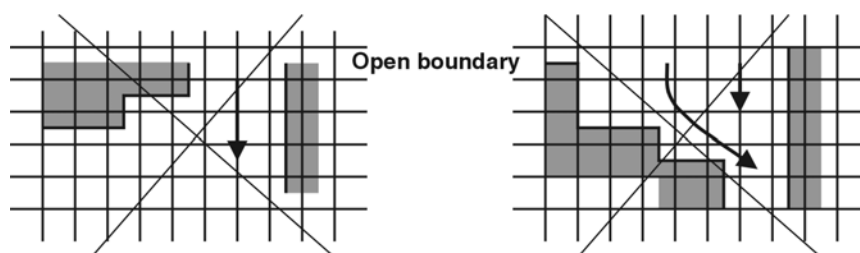

Figure 6.2 Sudden expansion and contraction of the flow close to an open boundary

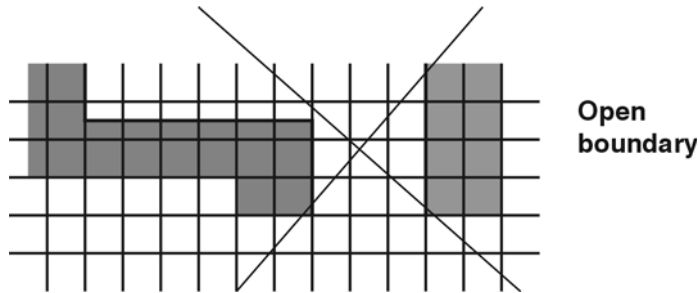

Figure 6.3 Special case of sudden contraction, permitted for level boundaries

- You should especially avoid a situation like the one in Figure 6.3. However, MIKE 21 will accept it if levels (not fluxes) are prescribed at the open boundary in order to permit flooding and drying just inside the boundary.
- Although MIKE 21 can handle flooding and drying just inside a level boundary, you should normally not place the open level or flux boundaries too close to shallow areas which might dry out. Points at the open boundaries should never dry out.
- If possible rotate your model so that the main flow direction inside the model is more or less parallel to one of the coordinate axes.
- Try to place the origin of your model (which is normally the lower left corner) in a well defined set of coordinates in the surrounding coordinate system (which will often be the UTM coordinate system or geographical longitude and latitude). This, together with a “nice” orientation of your model relative to north, will facilitate the transformation of model grid coordinates into the surrounding coordinate system.

### 6.1.3 Selecting the grid spacing

Although the selection of the grid spacing and of the model area are closely connected there are a number of special considerations (as listed below) which you have to make when selecting the grid spacing. Except for the first one and the last one they are all related to the Courant number and thus the speed with which the information travels in the model. Please see Courant Number (p. 66) for a description of these terms.

- First of all your grid should resolve all the variations in the bathymetry which are important for the flow you wish to simulate.
- MIKE 21 will probably not become unstable if you have an isolated bump or hole in your bathymetry (provided that it is not close to a boundary), see Figure 6.4. However, a series of bumps and holes along a grid line might lead to instabilities if the flow direction is parallel to this grid line and the Courant number is greater than 1, see Figure 6.5.

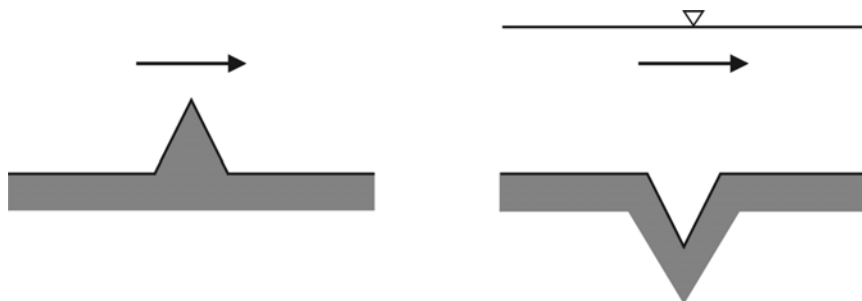

Figure 6.4 Unwise bathymetric resolution

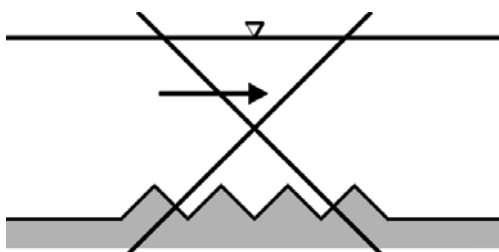

Figure 6.5 Unstable bathymetric resolution for Courant numbers greater than 1

- If you cannot avoid channels which run at an angle of 45 degrees to the grid, the grid spacing and time step should be chosen as shown in Figure 6.6.

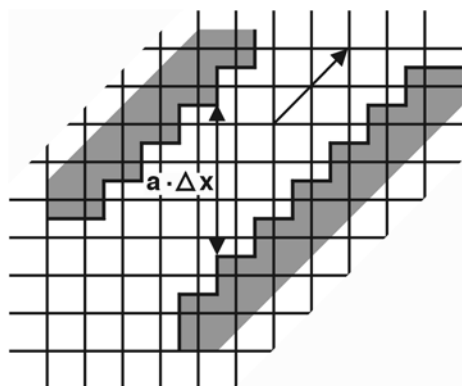

Figure 6.6 Flow in a channel at 45 degrees



- Closely related to the condition above is the treatment of deep channels in shallower areas. When you model an area with narrow and deep channels it is quite normal that the channels are only one or a few grid points wide. You should, however, take care when the narrow channels cross from one grid line to the next. If the flow in the channel is of importance the number of overlapping grid points should be greater than the local Courant number. This will ensure that the flow information is transferred properly up the channel, see Figure 6.7.

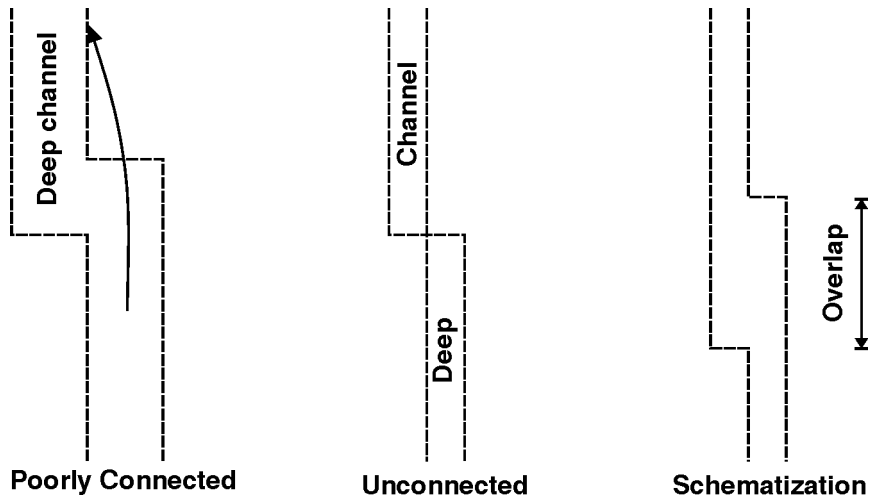

Figure 6.7 Schematisation of a narrow channel

- You should avoid alternating land-water-land-water boundaries as shown in Figure 6.8 if the Courant number is larger than 1.

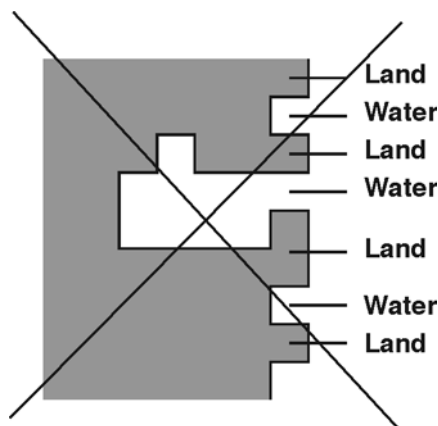

Figure 6.8 Schematisation of land, which should be avoided



Areas that are subject to flooding and drying should not be made completely level but given a gentle slope towards the nearest area with deep water. This will ensure that a series of one point ponds is not left in the otherwise dry areas when the water withdraws.

#### 6.1.4 Selecting the reference level

In principle you can use any reference level in the hydrodynamic computations (that is in the bathymetry), but it is recommended to use mean sea level (MSL).

The depths on sea charts are, however, normally given relative to the lowest astronomical tide (LAT) and the bathymetry will therefore normally be entered (digitised) relative to this datum. You can add the difference between MSL and LAT to all grid points in the bathymetry data file using the Grid Editor facility for editing.

You will have to make sure that all the sea charts you are using to prepare the bathymetry are relative to the same datum. If this is not the case, you must choose a common datum and then convert all depths to this datum. In the same way, all the water level recordings you will use must also be converted to the same datum.

#### 6.1.5 Specifying the bathymetry

Before you start a simulation you have to prepare the bathymetry in a data file or, in other words, digitise your model area. There are several ways to do this:

- Draw the computational grid on a piece of transparent paper, put it on top of the sea chart and write the depth for each grid node on the paper. Then enter the depth values in a file using the data file editor for 2D matrices provided with MIKE 21.
- If you have a digitising tablet compatible with the MIKE 21 digitising program you can use this to create a file with (x,y) coordinates and the corresponding depths. This data can then be gridded using the Bathymetry Editor facility of MIKE 21. An example with a step-by-step description of how to use the Bathymetry Editor is included with the installation. Please find this example in your installation folder under Examples\MIKEZero\BatEdit.
- If you have your depth information in digital form you can create an ASCII file (.txt) and enter this file into the standard data file format using the Grid Editor.

In all cases please note that the depth given to a grid point represents not only the depth right at that point, but the area surrounding the grid point, see Figure 6.9.

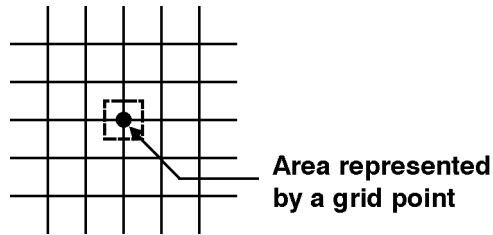

Figure 6.9 Depth representation in the grid

### 6.1.6 Sign convention

Depth values for grid points below the chosen datum are negative in the MIKE 21 Flow Model.

### 6.1.7 Additional area description

In addition to the bathymetry for your model area the following area information should also be specified:

- The initial surface elevation in the area. Because the model initialises the fluxes or current velocities to zero, you must specify an initial surface elevation that is in agreement with these conditions. In practice this means that you should specify a value that matches the boundary conditions at the first time step. If the model area is large and the surface levels at the open boundaries differ substantially, you should create a data file with an initial surface elevation at each grid point. However, in most cases you can just use the average surface elevation at the open boundaries.
- The latitude and longitude at the lower left corner of the model should be provided through the bathymetry data file. In dfs2 data files there is a possibility to store information about the applied projection zone (e.g. UTM-32), and this information is used as the default projection zone. In dt2 data files there is no information about the applied projection zone, and therefore the default projection zone is calculated as the UTM zone in which the origin is located. The user may choose to overwrite the default projection zone. If no geographical information is available through the bathymetry data file or if the projection zone “NON-UTM” is chosen, then Coriolis forcing is not applied.
- The orientation of your model (also provided in the bathymetry data file). This is defined as the angle between true north and the y-axis of the model measured clockwise. A mnemonic way of remembering this definition is by thinking of NYC, which normally means **N**ew **Y**ork **C**ity, but which for our purpose means “from **N**orth to the **Y**-axis **C**lockwise”, see Figure 6.10.

### True north

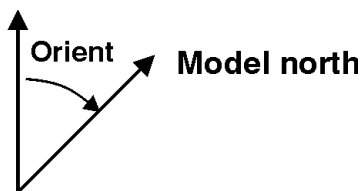

Figure 6.10 Definition of model orientation

- A value representing land (provided in the bathymetry data file, see below). This means that all grid points with a depth value equal to or greater than the value you specify will always be considered to be land and will not be subject to possible flooding and drying.
- Flooding and drying parameters. Please refer to Flooding and Drying (p. 69) for a detailed description of this facility.



Please note: Bathymetry data files must contain a custom block called M21\_Misc which consists of 7 elements of type float:

- The first element is the orientation.
- The third element is a flag and the value -900 indicates that the data file contains geographic information.
- The fourth element is the value representing land.
- The rest of the elements are not used in bathymetry data files.

## 6.2 Bed Resistance

### 6.2.1 General description

You can choose between two ways of describing the bed resistance in the MIKE 21 Flow Model: either as a Chezy number or as a Manning number. In both cases the bed resistance used is

$$\frac{g \cdot u \cdot |u|}{C^2} \quad (6.1)$$

where  $g$  is gravity,  $u$  is velocity and  $C$  is the Chezy number. Manning numbers are converted to Chezy numbers as follows

$$C = M \cdot h^{1/6} \quad (6.2)$$

where  $M$  is the Manning number and  $h$  is the water depth. The units of Chezy numbers and Manning numbers are respectively  $\text{m}^{1/2}/\text{s}$  and  $\text{m}^{1/3}/\text{s}$ .





Please note that the Manning number used in MIKE 21 is the reciprocal value of the Manning number described in some textbooks.

## 6.2.2 Specifying the bed resistance

A bed resistance number is assigned to each grid point in the model area. You can specify this in MIKE 21 in two ways:

- as one value which is given to all grid points
- as a map similar to that for bathymetry with a resistance value for each grid point

## 6.2.3 Recommended values

If the relative variation of the water depth is considerable you should specify Manning numbers. Values in the range 20-40  $\text{m}^{1/3}/\text{s}$  are normally used with a suggested value of 32  $\text{m}^{1/3}/\text{s}$  if no other information is available. In an estuary with tidal channels you can use a value of 25  $\text{m}^{1/3}/\text{s}$ .

If you apply Chezy numbers a model calibration can normally be achieved with values in the range 30 - 50  $\text{m}^{1/3}/\text{s}$ .

Because of the definition of the resistance numbers the following applies:

- Using a smaller resistance number increases the bed resistance
- Using a greater resistance number decreases the bed resistance

## 6.2.4 Remarks and hints

If the boundary conditions at one of your boundaries are inaccurate and you therefore have stability problems (blow-ups) at this boundary, you can specify a small band (2 to 4 grid lines) with a very high resistance. Manning numbers in the range 5 -10  $\text{m}^{1/3}/\text{s}$  have been applied successfully. However, this method should only be used if it is impossible to improve the boundary conditions. Furthermore, the simulation results in the area around the small resistance numbers should be used with caution.

When carrying out a tidal calibration you can use the bed resistance to increase or decrease the tidal amplitude. The tidal phase is adjusted by changing the water depth. When the depths have been read from a sea chart, increasing the depth is all the more justifiable as these charts often give the minimum depths, which are more important to shipping than the maximum depths.

Because  $h^{1/6}$  is calculated for each grid point and at each time step when the Manning formulation is selected rather than the Chezy formulation, the com-



putational time is increased. Please see CPU Time (p. 66) for an estimate of the additional CPU time required.

## 6.3 Blow-up

Please inspect carefully the **log** file.

## 6.4 Boundary Conditions

### 6.4.1 General description

If the description of the bathymetry is the most important task in the modelling process then the description of the water levels and flow at the open boundaries (in short called the “boundary conditions”) is the **second most important task**. The better the boundary conditions the better the results and the fewer the instability problems.

The MIKE 21 Flow Model solves the partial differential equations that govern nearly-horizontal flow and, like all other differential equations, these need boundary conditions. As the unknown variables are surface elevation and flux densities in the x-direction and y-direction you must, in principle, specify two of these three variables in all grid points along the open boundary at each time step. However, in most applications you only know the surface elevation and possibly the general flow direction or you know the total flow through your boundary and its general direction. The input to the hydrodynamic module of the MIKE 21 Flow Model has therefore been structured accordingly.

You can choose between the following two combinations of boundary input:

- Specify water levels and the direction of the flow.  
The water levels can be constant or varying along the boundary line. The variation in time can be either constant, sinusoidal or vary as specified in a type 0 or a type 1 data file. Finally a transfer file can be used for water level, which is obtained by use of the M21 tool Transfer Boundary.  
The directions can either be specified as default, meaning perpendicular to the boundary, or read from a type 1 data file. The data file must contain a direction for each individual grid point along the boundary.
- Specify a flux boundary, as either discharge (constant, sinusoidal, type 0), flow flux (type 1, transfer) or Rating curve (type 0), through the boundary and the flow direction.  
The discharge can be constant in time, have a sinusoidal variation or vary as specified in a type 0 data file. The distribution of the total flow in the individual grid points along the boundary is calculated by MIKE 21 relative to the depth.



Type 1 and transfer Boundary conditions are also possible, but in this case the values in the cells of the input files represent the flow flux at each cell, instead of the total discharge.

A Rating curve is a dfs0 file with axis type 'Relative item axis'. The data represent the variation of a discharge (as item) as a function of the water level which is specified in the axis.

The direction should be given in the same way as for level boundaries.

## 6.4.2 Specifying the boundary conditions

In the boundary specification dialog you are presented with a list of the open boundaries the model has been able to detect.

The model may detect the open boundaries by searching for lines of adjacent water points placed along the four sides of the bathymetry. Note, the actual locations of the open boundaries were defined when you digitised the bathymetry.

In most cases the detected boundaries will correspond to those you have planned. If this is not so, you should select "User specified" boundaries and then further specify the number of open boundaries and their position in the model, see the section "User specified" boundaries.

In the Boundary dialog under "HD parameters" you specify the type of boundary data, how these vary in time and space, and finally you can enter a number of options:

First you must specify the boundary type (a "level" or a "flux" boundary) from the combo-box selector. For a flux boundary please note that the sign on the fluxes determine the flow direction relative to the model coordinate system: inflow is positive on the left and bottom side, while it is negative on the top and right side, and vice versa for outflow.

Then you specify the variation of the water levels or fluxes in time and space.

They can be given in one of the following ways:

- A constant value used at all grid points along the boundary and throughout the whole of the simulation. This is most useful if a stationary flow field is required.
- A sinusoidal variation during the simulation period, for example, a tidal variation can be specified. The variation is calculated as follows:

$$\text{Value} = \text{Reference Level} + \frac{1}{2} \cdot \text{Range} \cdot \sin\left(2\pi \cdot \frac{N \cdot \Delta t - \text{Phase}}{\text{Period}}\right) \quad (6.3)$$



where  $N$  is the time step number and  $\Delta t$  is the time step.

The same value is used at all grid points along the boundary.

- A variation as given in a type 0 data file. The data file gives the same value to all grid points along the boundary. If the time step in the data file differs from the time step in the model simulation then a cubic interpolation is used.
- A variation as give in a type 1 data file. The data file defines the variation in time for each grid point along the open boundary. The data file must have exactly as many points as there are grid points along the axis. If the time step differs from the time step in the model simulation then a linear interpolation is used.

This possibility allows you to introduce variations in the boundary conditions along the open boundary.

- Flow conditions obtained from an encompassing model. This boundary type, called a transfer boundary, is prepared from a previous model simulation with a model including the area of the boundary.

The transfer data file, which also is a type 1 data file, contains information about the water levels and the flux densities in the  $x$  and  $y$ -directions.

- Discharge versus water level relationship given in a relative axis time series file (dfs0). The data describes the resulting water level given the computed discharge out of the model.



**Note:** In all cases must the reference level of the boundary data equal the reference level of the bathymetry data.

Finally you can through three options control how the boundary data should be applied:

- What strategy to use when calculating the Flux Along the Boundary (FAB). There are the following possibilities:

0: The flow is assumed perpendicular to the open boundary, i.e. the FAB is zero.

1: The direction of the flow is obtained by extrapolation from the flow one grid point inside the boundary. When the direction has been extrapolated, the FAB can be calculated.

2: The direction of the flow at the boundary is explicitly given. The FAB can then be calculated.

12: This is a combination of 1 and 2. When the flow direction is out of the boundary, type 1 is chosen, otherwise type 2.



Using either 2 or 12, the third option (default flow directions) can be used to define the actual direction of the flow at the boundary.

- Should your boundary data be tilted to accommodate for a possible wind and/or Coriolis' set-up along the boundary? A description of this facility is given below in the section Recommended selections and values.

To activate the tilt facility, make your tilting method selection from the combo-box, you will then be prompted for which point to tilt around.

This facility is not enabled when the boundary is a flux boundary or if the boundary data is specified as transfer data.

- What direction does the flow have at the boundary? The default flow direction is perpendicular to the boundary. If the flow in your model is not perpendicular to the boundary, you should create a type 1 data file with flow directions for each individual grid point along the boundary. The directions should be given in degrees from true north and measured positive clockwise.

The data file with the directions should only have one time step, i.e. the flow directions will be constant during the whole of the simulation. However, the directions are only used during inflow. During outflow the directions are extrapolated from the flow inside the model.

To activate the direction facility, select it from the combo-box and enter the name of the data file with the directions.

This facility is not enabled when the boundary data is specified as transfer data.

### 6.4.3 User specified boundaries

In case the open boundaries do not correspond to those you had planned, you must specify "User specified" boundaries and then give the number of open boundaries in the model. Further you will in the boundary definition dialog have to specify the location of the open boundary. That is the coordinates of the first water point and the last water point along the boundary grid line.

It will be very unusual that you yourself have to specify the locations of the open boundaries. It is only relevant in the following two situations:

- You have a long open boundary broken by, say, two small islands. The menu will show you this boundary as three smaller boundaries. If the boundary conditions are either the same for all three boundaries or it is most conveniently to keep the boundary data for the whole boundary in the same type 1 data file, or transfer file, you can define the three boundaries as one boundary.

You will then have to specify the start point as the first water point on the first line and the last point as the last water point on the third line. The boundary line will then contain a few land points; but this is not an error.

- You want to have an internal open boundary in your model. An internal boundary is a boundary that is not located on one of the model sides. You can use an internal boundary to keep your model size small, see Figure 6.11.



**Note:** If you want to include an internal boundary in your model, you must fill the area behind the boundary with land points.

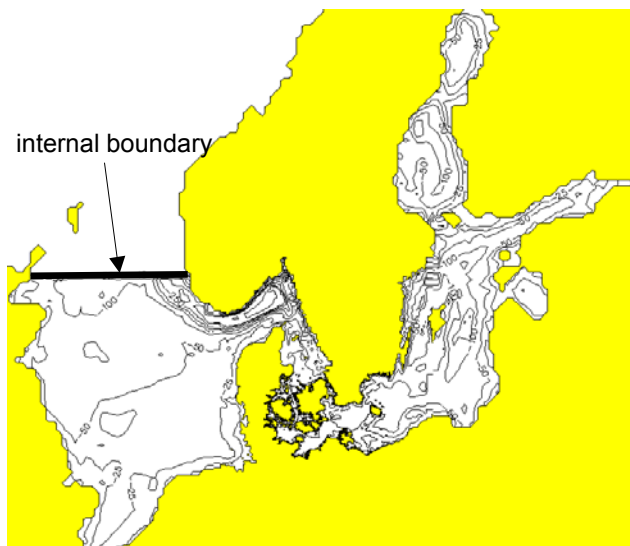

Figure 6.11 Example of internal boundary

Due to the computational structure of MIKE 21 there are a few restrictions to where a boundary can be located, see Figure 6.12.



**Note:** All water points on the model sides must be included in an open boundary definition.

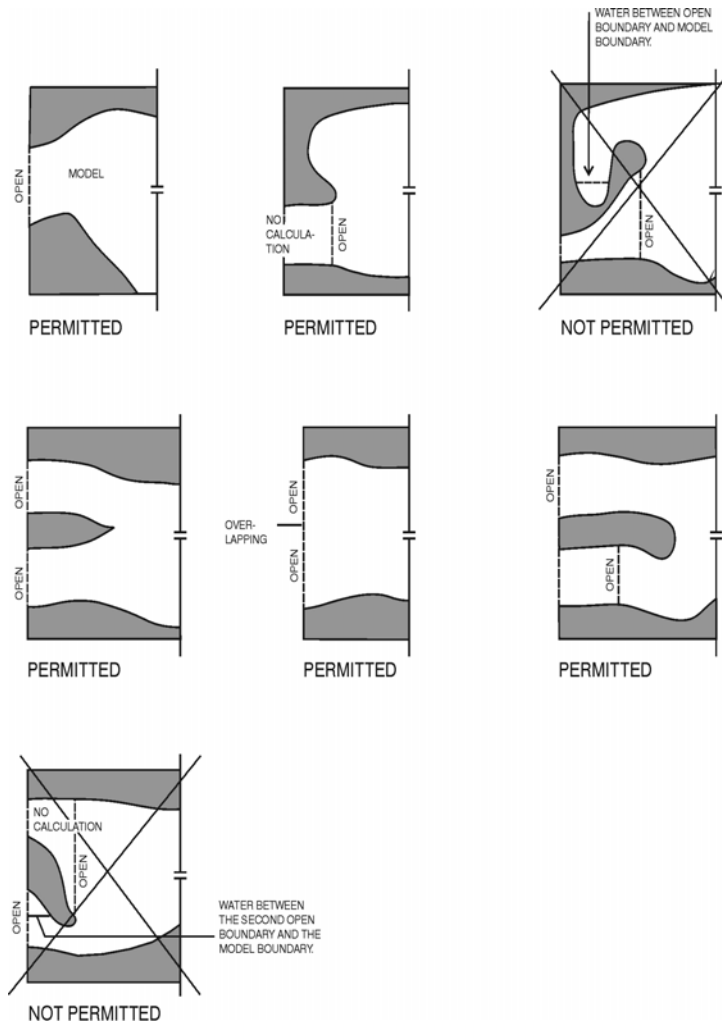

Figure 6.12 Restrictions on the location of an open boundary

#### 6.4.4 Recommended selections and values

If you specify water levels for a boundary you can normally assume that there is no spatial variation along the boundary. However, in certain situations you may wish to specify a non-horizontal water level since a horizontal water level may give unrealistic results. These situations are treated in the following way:

- If, for example, you are carrying out a tidal study and have a tidal station at each end of the open boundary, a linear variation along the boundary (or parts of it) should be specified. You do that by having a type 1 data file with the boundary conditions. The data file can be created with Profile Editor under MIKE Zero.

- Another situation where a horizontal water level at the boundary is unrealistic is in the presence of wind and the Coriolis force. If you keep the water level horizontal you will get a large inflow together with a large outflow at the same boundary, especially in a steady state situation, as the water level should actually be tilted. The effect is illustrated in Figure 6.13. You should therefore specify a tilt point so that MIKE 21 will tilt the boundary to avoid this unrealistic flow pattern.

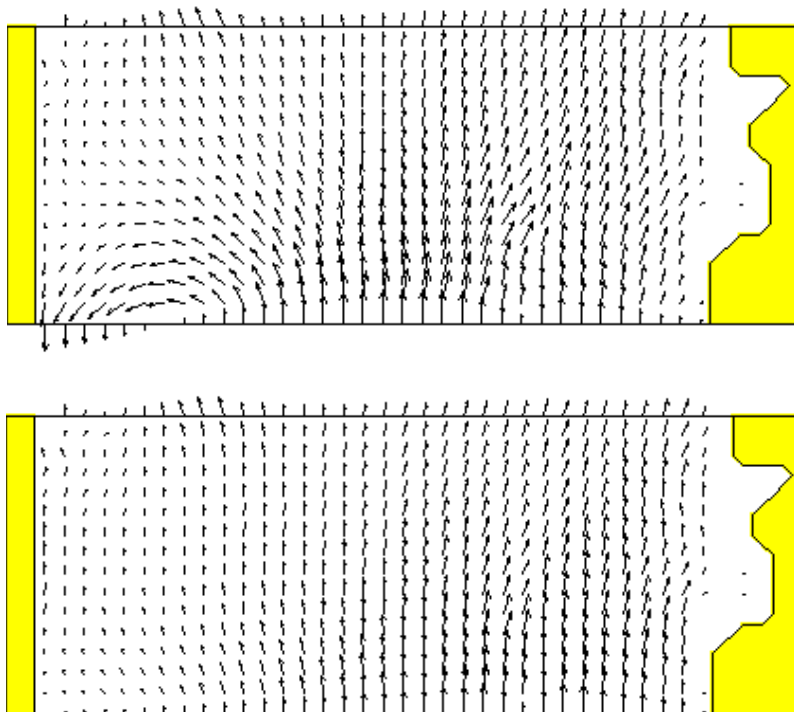

Figure 6.13 Before (upper) and after (lower) the tilting

MIKE 21 provides two alternatives for the tilting approach:

- linear tilting
- non-linear tilting.

With a selection of linear tilting MIKE 21 assumes the water level to follow a straight line which can be rotated around the tilting point. This approach has the advantage of smoothing the effects originating from a very jagged seabed.

The non-linear approach is more theoretically correct and provides a better estimate in many cases where you have a gentle slope on the seabed. The





tilting is calculated in each point along the boundary based on the steady state Navier Stokes equations.

It is assumed that the flow is perpendicular to the boundary. However, the correction of the flow will also work if the flow direction is nearly perpendicular to the boundary. You should keep this in mind when selecting how the fluxes along the boundary should be calculated: the method called type 12 together with a perpendicular inflow is recommended.

The difficulty in using the tilt facility lies in the specification of the tilt point. A good choice to begin with is the deepest point along the boundary. However, you might have to find the best point through trial and error.

If you have two adjacent boundaries you should also be careful not to create a conflicting situation in the corner.

If you specify the total flow through your boundary and select that it should be distributed relative to the depth, it will be distributed as it would have been in a uniform flow field with the Manning resistance law applied, i.e. is relative to  $h^{5/3}$ , where  $h$  is the depth. This distribution is, in most cases, the best one that can be applied.

#### 6.4.5 Remarks and hints

Accurate flow directions are more important when the flow is into the model, while they are of less importance at the outflow. This is because any errors at the inflow boundaries are transported into the model and may, therefore, cause instabilities.

Introducing open boundary conditions into a finite difference model is a very complex task as a number of different implementation solutions can be used. The input description as given above focuses on the description as seen from the user's practical point of view ("these data are available; how do I specify that to the model?"), while the description as seen from the numerical point of view is given in the Scientific Documentation.

### 6.5 Chezy Number

See Bed Resistance (*p.* 56).



## 6.6 Courant Number

### 6.6.1 General description

The Courant number is defined as follows:

$$C_R = c \frac{\Delta t}{\Delta x} \quad (6.4)$$

where  $c$  is the celerity,  $\Delta t$  the time step and  $\Delta x$  the grid spacing. For a tidal wave the celerity is

$$c = \sqrt{gh} \quad (6.5)$$

where  $g$  is gravity and  $h$  is the water depth.

As the information (about water levels and fluxes) in the computational grid travels at a speed corresponding to the celerity, the Courant number actually expresses how many grid points the information moves in one time step.

### 6.6.2 Recommended value

Normally you can have a maximum Courant number in your model of up to 5. The maximum value which you can use without having stability problems does, however, depend on your bathymetry:

- If you are modelling an estuary with tidal channels you should adhere to the rules given under Bathymetry (p. 49). Alternatively you can use a maximum Courant number of 1, in which case you should have no problems in resolving the flow in the channels. The CPU time requirements might, however, become very high.
- The MIKE 21 Flow Model is designed for Courant numbers up to about 20. You should, however, only allow these very high numbers in areas where the bathymetry is very smooth.

## 6.7 CPU Time

### 6.7.1 Factors influencing the CPU time

The CPU time required by a hydrodynamic simulation depends on the size of your model, on the number of time steps in your simulation, on which features you have specified for the simulation and on the general computational speed of your computer.



If you wish to estimate how a change in your specifications for a hydrodynamic simulation changes the CPU time required without specifying the model set-up and doing a verification, the following guidelines can be used:

- The CPU time varies linearly with the number of water points (or computational points) in the model.
- The CPU time also varies linearly with the number of time steps, if flooding and drying is not selected. If this feature is selected the variation as a function of the number of time steps is only approximately linear.
- The CPU time is increased by the factors listed below if the corresponding features are selected. The factor is relative to a simulation where no results are saved on disk and where none of the features are selected.

**Factor.**

1.10:Manning numbers applied instead of Chezy numbers.

1.15:Flooding and drying.

1.25:Saving the results in all grids for each time step.

If you wish to calculate the CPU time required by a simulation (in real CPU seconds, not elapsed seconds) the following formula can be used:

$$\text{Number of time steps} \times \text{Number of water points} \times \text{Factors} / \text{BCS}$$

where BCS (basic computational speed) is the number of water points which your computer processes in one CPU second. “Factors” refers to the factors listed above.

## 6.8 Current

See Velocity (*p. 94*).

## 6.9 Disk Space

### 6.9.1 Small files

The disk space required for your simulation depends mainly on the amount of results you request to be saved. During a simulation only two or three other files, in addition to the data files containing the results are created:

- The specification file (also known as the **pfs** file, Parameter File Standard) containing the simulation specifications. This file will be placed in your present working directory and have a file extension of **m21**. It will only take up approximately 2 Kbytes.



- The **log** file describing the model set-up, the statistics of the files used and created during the simulation and a message for each time step completed. The file extension of this file, which will also be placed in your present working directory, is **log** and it will only take up to 200 Kbytes on the disk.
- A file for the continuation of a simulation, the **hot** file. This file only takes up disk space equivalent to 9 times the space taken up by the bathymetry file. This means that the hot file will not take up more space than 100 - 200 Kbytes.

## 6.9.2 Large files

The amount of data generated by a simulation may be very large. Therefore you should only save as much data as is needed for your further work. Nevertheless very large files will often be generated.

If you wish to calculate the disk space required for a single output data file the following formula can be used. The result is in bytes:

$$4 \cdot \left[ 3 \cdot \left( \frac{N_{last} - N_{first}}{N_{frequency}} \right) + 1 \right] \cdot \frac{J_{last} - J_{first} + 1}{J_{frequency}} \cdot \frac{K_{last} - K_{first} + 1}{K_{frequency}} + 1052 \quad (6.6)$$

where N denotes time steps, J denotes points in the x-direction and K points in the y-direction.

## 6.9.3 Remarks and hints



Please note that MIKE 21 does not check whether or not you have enough free disk space for your requested output files.

## 6.10 Evaporation

In applications where the evaporation is important, you can include evaporation in your simulation.

This is done either as a constant value or as a time series (type 0 data file), which then is applied to the entire model area, or as a time series of maps (type 2 data file) in which case each grid point is assigned its own value. The evaporation rate is specified in mm/day.

- You can include evaporation in your simulation in three different ways.
- If your simulation does not include any density variations you can include evaporation by specifying the evaporation rate in the Source and Sink dialog.



- You can also use the precipitation facility to include evaporation in your simulation. This is simply done by selecting the “included as net-precipitation” option and specifying a negative precipitation. See the Precipitation (p. 81) description for more details.

## 6.11 Flooding and Drying

### 6.11.1 General description

A very valuable facility in MIKE 21 is its capability to include and exclude computational areas dynamically during the simulation or, in other words, compute the flow in an area which sometimes dries out and sometimes is flooded (e.g. tidal flats).

You should use this facility whenever points in your model might be flooded or dried out.

### 6.11.2 Specifying flooding and drying

You enable the possibility of flooding and drying of areas in the Flood and Dry dialog. You will then be asked at what depth the computational points should be taken out and reentered into the computations.

### 6.11.3 Recommended values

#### Coastal flooding

The **Drying Depth** can normally be specified in the range 0.1 - 0.2 m and the **Flooding Depth** in the range 0.2 - 0.4 m. A difference between the two depths of 0.1 m is recommended. If the water level variations occur very rapidly (compared to the time step) you can increase the difference to 0.2 m or even more.

#### Inland flooding

In certain situations MIKE 21 may yield negative water depths. This can occur for instance in areas with steep gradients in the bathymetry (or topography) or by a relatively large time step in the model. To minimize the potential for mass falsification you should generally use smaller flood and dry levels for inland flooding. Appropriate values in inland flooding could be **Drying depth** in the range 0.001 - 0.02 m and **Flooding depth** in the range 0.002 - 0.05 m, where Flooding depth > Drying depth.



**Note:** The drying and flooding depth **must** be larger than 0.0001 m and 0.0002 m, respectively.



## 6.11.4 Remarks and hints

The CPU time increases when you request that checks be made for flooding and drying. For an estimate please see CPU Time (p. 66).

In order to avoid drying and flooding following rapidly after each other (which will lead to instabilities in the computations) a point is not dried out if the water depths at the four grid points immediately below, above, to the right and to the left all are larger than the flooding depth. However, if the depth at the point in question is nearly zero, it is always dried out.

A point is flooded if the water level at one of the four grid points immediately below, above, to the right or to the left is more than the value you have specified as the minimum flooding depth.

If you have instabilities in your model, you might be able to avoid them by first of all checking for flooding and drying after each time step. If the problems persist, you can increase the drying and flooding depths and, in particular, the difference between the two.

Continuity is preserved during the flooding and drying process as the water depths at the points which are dried out are saved and then reused when the point becomes flooded again. However, in cases of excessive flooding and drying, e.g. during rainfall on otherwise dry land, the model may resort to numerical water level correction in order to stabilize the model. This may give reason to inconsistency in the water balance. For more details, and how to reduce inconsistency, please see the section on Flooding and Drying in the MIKE 21 HD Scientific Background.

## 6.12 Froude Number

The Froude number,  $F$ , which may be selected as output in the HD module is based on the equation

$$F = V/(\sqrt{gh}) \quad (6.7)$$

where  $V$  is current speed,  $g$  is gravity and  $h$  is the water depth.

## 6.13 Hot Data

### 6.13.1 General description

You can start your simulation either from scratch (a “cold start”) or on the basis of a previous simulation (a “hot start”). In the latter case you need to save information about the simulation you wish to continue. These data are called “hot data”.



The hot data consist of the following model information:

- Model dimensions and grid spacings, time step and time at end of simulation, information on flooding and drying, the latitude of the model and its orientation (relative to true north), and the value above which a point is always considered to be land
- Bathymetry
- Initial surface elevation (i.e. the surface elevation at the last time step in the previous simulation)
- Fluxes in the x-direction at the last time step
- Fluxes in the y-direction at the last time step
- Fluxes in the x-direction a full time step before the last one
- Fluxes in the y-direction a full time step before the last one
- Water depth in dried out points (if you had chosen the flooding and drying facility).

Thus, if you use a hot start, you need not (and cannot) specify the data listed above.

### 6.13.2 Specifying the hot data

You specify that you wish to be able to continue the simulation you are about to execute by selecting “Generate Hot Start” in the Results dialog, and then writing the **name** of the hot data file.

You specify that you wish to do a simulation as a continuation of a previous one by selecting “Hot Start” in the Bathymetry dialog, and then writing **name** of the hot data file created earlier.

## 6.14 Infiltration

### 6.14.1 General description

Infiltration describes the flow of water from the free surface zone to the infiltration zone below the ground level.

This effect may be a relevant factor in flood modelling where even a small precipitation can invoke flow on a dry surface. The effect of infiltration is included by subtracting the net infiltration volume from the volume of water in the individual grid cell. This is similar to a sink effect in the spatial domain however the effect will not affect the overall flow. The resulting water depth can be expressed by

$$H(j,k) = H(j,k) - V_{infiltration}(j,k) / (\Delta x \times \Delta y) \quad (6.8)$$

where  $V_{infiltration}$  is the net infiltrated volume in the grid cell.

### 6.14.2 Net infiltration rate

The most direct way of including infiltration is to specify the net infiltration rate.

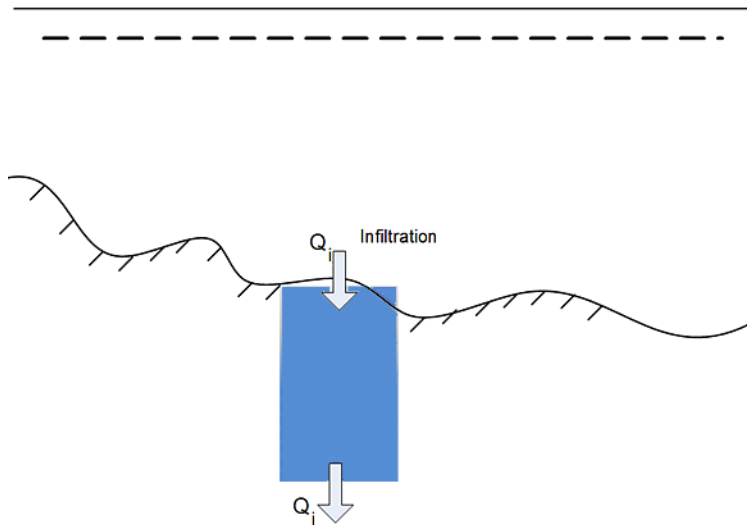

Figure 6.14 Definition of net infiltration rate



**Note:** The specified infiltration rates will always be fully effectuated as long as there is enough water available in the cell. It is possible that the infiltration flow completely drains the free surface zone from water and thus creates a dried-out point in the two-dimensional horizontal flow calculations.

### 6.14.3 Infiltration and leakage

It is possible to calculate the net infiltration rate by a simplified model that describes the infiltration from the free surface zone to the unsaturated zone and the leakage from the unsaturated zone to the saturated zone. This way the model can e.g. account for a decreased storage capacity due to previous rainfall events.

The model assumes the following:

- The unsaturated zone is modelled as an infiltration zone with constant porosity over the full depth of the zone.





- The infiltrated volume between the free surface zone and the infiltration zone is based on a constant flow rate, i.e.  $V_{\text{infiltration}} = Q_i \times \Delta t$  where  $Q_i$  is the prescribed infiltration rate.
- The leaked volume between the saturated and unsaturated zone is also based on a constant flow rate, i.e.  $V_{\text{leakage}} = Q_l \times \Delta t$  where  $Q_l$  is the prescribed leakage rate.

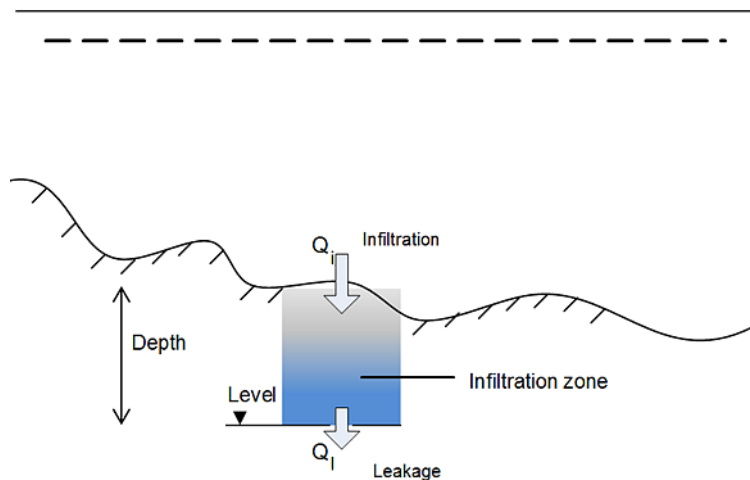

Figure 6.15 Definition of infiltration with storage and leakage



**Note:** The infiltration flow cannot exceed the amount of water available in the free surface water zone nor the difference between the water capacity of the infiltration zone and the actual amount of water stored there. It is possible that the infiltration flow completely drains the free surface zone from water and thus creates a dried-out point in the two-dimensional horizontal flow calculations.

## 6.15 Initial Surface Elevation

See Additional area description (p. 55).

## 6.16 Inundation statistics

Inundation statistics can be calculated and stored as a dfs2 file. Seven quantities are calculated and stored as separate items in the output file:

1. maximum water depth,  $H_{\text{max}}(j,k)$
2. time at maximum water depth,  $T@H_{\text{max}}(j,k)$
3. maximum flux magnitude,  $F_{\text{max}}(j,k)$



4. time at maximum flux magnitude, T@Fmax (j,k)
5. maximum current speed, Vmax (j,k)
6. current direction at maximum current speed, Dir@Vmax (i,j)
7. time at maximum current speed, T@Vmax (j,k)
8. duration above threshold (Optional)

These are all initialized as delete values and subsequently updated according to the specified update frequency (wet points only).

Water depths are grid cell centred values. All items in the inundation statistics are evaluated at the cell centre, making them directly identifiable with the values from the HD output files.



Please note that the 8 characters "Aaa.dfs2", are added to the user specified file name automatically. Here "Aaa" is an area number identification where the uppercase "A" is fixed and "aa" is replaced by the respective area number (e.g. "A01" for the main area, area number 1, and "A02" for area number 2, etc).

## 6.17 Manning Number

See Bed Resistance (*p.* 56).

## 6.18 Multi-cell overland Solver

The MIKE 21 multi-cell overland solver is designed for simulating two-dimensional flow in rural and urban areas. The overall idea behind the solver is to solve the modified equations on a coarse grid taking the variation of the bathymetry within each grid cell into account. Results are presented on the grid that takes the fine scale bathymetry into account.

### 6.18.1 Constructing the fine and the coarse bathymetries

To apply the multi-cell overland solver two bathymetries must be constructed

- A bathymetry with a coarse resolution which defines the calculation grid and the location of boundary conditions
- A fine resolution bathymetry which is used for result presentation and evaluation of hydraulic parameters within a coarse grid cell

The two bathymetry must obey a number of rules



1. The extent of the bathymetries must be identical.
2. The number of grid cells in the J and the K direction for the fine grid must be dividable by the number of cells in the J and K direction respectively in the coarse grid i.e. the number fine grid cells within a coarse grid cell must be integer.

The first of these points may at first glance easy to satisfy simply by ensuring that the two bathymetries have the same origo and the same length in the X and the Y direction. A word of caution is in order here. The origo of a dfs2 file which has a true projection such as a UTM type associated with it refers to the centre of the cell (j,k)=(0,0). The situation is illustrated in Figure 6.16.

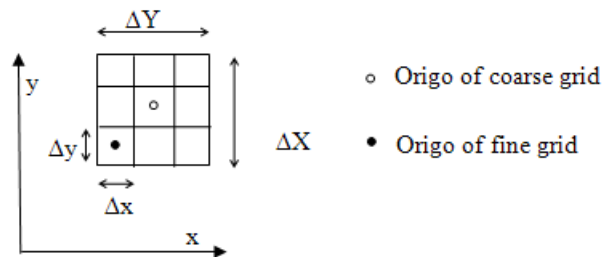

Figure 6.16 The location of the origo of the coarse and fine grid when a true projection is applied.

The Origo of the fine grid should be placed according to

$$O(x, y) = O(X, Y) + \left( \frac{(1 - N_{J, fine})}{2} \Delta x, \frac{(1 - N_{K, fine})}{2} \Delta y \right) \quad (6.9)$$

where the capitalized X and Y refer to the origo of the coarse grid and  $N_{J, fine}$  and  $N_{K, fine}$  refer to the number of fine grid cells within a coarse grid cell in the J and K direction respectively.

As a rule of thumb the difference in grid size should be not be higher than a factor 4 to 5.

Along the boundaries the topography from the coarse grid is used i.e. the bathymetry in the fine grid is modified to be equal to the coarse grid at boundaries. To ensure stability is recommended to smooth out the bathymetry of the fine grid close to boundaries to avoid sudden changes in the water depth.

True land points are defined by the coarse grid and any land points will be transferred to the fine bathymetry at run time.



**Note:** All values in the fine bathymetry must be lower than the specified land value in the coarse bathymetry.

## 6.18.2 Evaluation of hydraulic parameters within a cell

The methodology adapted for the multi-cell overland solver requires an evaluation of the hydraulic parameters such as the flooded area within a grid cell. The flooded area within a grid cell is illustrated in Figure 6.17.

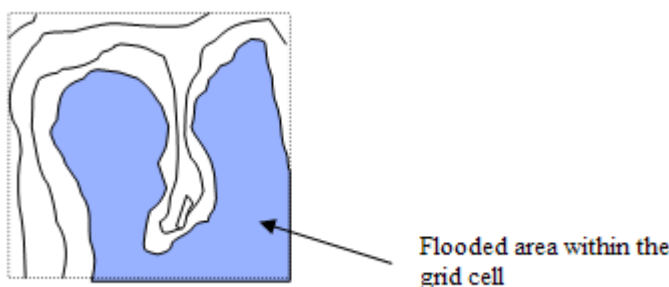

Figure 6.17 The flooded area is a function of the surface level within a grid cell.

The calculation of the flooded area, hydraulic radius, flow area within a cell etc. may be a time consuming process. For this reason MIKE 21 evaluates these parameters at a number of levels within each cell in a preprocessing initialisation phase. The calculated parameters are stored in three dimensional arrays (in memory) which are subsequently used at each time step in the simulation.

By default MIKE 21 calculates the parameters at 100 equidistant levels between the highest and the lowest point within each cell. The number of levels may be adjusted through the adding an optional parameter in the hydrodynamic section of the input file. The parameter is termed *Number\_Levels\_Overland*.



Note that the higher this value is, the greater the amount of memory is reserved for processed data. On the other hand if the value is too small the variation of the topography within a grid cell will not be sufficiently resolved. The number should reflect the variability within one coarse grid cell.

## 6.19 Orientation

See Additional area description (p. 55).



## 6.20 Output Files

### 6.20.1 General description

Computers are not yet so powerful that a simulation can be run each time a plot of, for example, the current field is needed. Therefore it is necessary to store the basic results from the simulations. On the other hand, the amount of output produced by a single simulation is often so large that it is necessary to limit the amount of output saved. You therefore have the option of saving up to 18 output files.

### 6.20.2 Specification of output files

In the Results dialog you first specify how many output files you wish to produce from the simulation (maximum is 18). You can then specify the contents of each data file:

- Specify the output files type: 0 (point series), 1 (line series) or 2 (area series).
- Specify the spatial and temporal sub-set of the data. This is best done using the pop-up dialogs, which is activated with the buttons in the column after the 'Time' column. Grid line series (type 1 data files) is specified by choosing identical 'First Point' and 'Last Point' in either 'J direction' or 'K direction'. For points series (type 0 data files) you can choose the number of points in each file.
- Specify the data file (name) and title of the output file.
- Finally select the desired output items.



**Note:** The selection of the first item (Water level) or first three items (Water level, P flux and Q flux) correspond to the standard 'level' (Data type = -1) or 'level and flux' output files (Data type = 1), respectively. When storing your own selection of items (e.g. Velocity or Shear Stress in the two directions) the data type is set to 0.

If the dfs2 file is created as a standard "level and flux" file then other MIKE Zero components such as Plot Composer, Result Viewer and the MIKE Zero Toolbox statistics can display and process other variables - surface elevation and velocities - derived from these items.

### 6.20.3 Remarks and hints

One way of following the progression of your simulation is by following the number of time steps written in your log file (or one of them). In most post-processing tasks you start by specifying the data name and after having done



so, you are presented with the description of the data. This description includes the number of time steps already written and thus finished.

## 6.21 Pier Resistance

### 6.21.1 General description

The impact of bridge piers on the flow conditions can be included in the hydrodynamic calculations by activating the pier resistance option.

The MIKE 21 solution method involves the use of a finite difference grid with a selected grid mesh size. A typical choice of say 100-1000 metres implies that bridge piers with a typical horizontal dimension of say 5-10 metres are not directly resolvable in the computational grid. Therefore, the presence of piers must be modelled by a subgrid scaling technique.

The resistance to the flow due to the piers is modelled by calculating the current induced drag force on each individual pier and equate this force with a shear stress contribution compatible with the MIKE 21 momentum formulation.

Thus

$$\tau_p \cdot \Delta x \cdot \Delta y = n \cdot F \quad (6.10)$$

where

$\tau_p$ : equivalent shear stress

$F$ : drag force on one pier (the sign of  $F$  is such that  $\tau_p$  acts against the current direction)

$n$ : number of piers allocated to one grid point (density of piers)

$\Delta x, \Delta y$ : grid spacing

The resulting shear stress at the bottom is then implemented as the sum of  $\tau_p$  and the bottom shear stress,  $\tau_o$ .

The drag force is determined from

$$F = \frac{1}{2} \rho C_D B_e H_e \cdot v^2 \quad (6.11)$$

where

$C_D$ : drag coefficient



- $\rho$ : density of water
- $B_e$ : effective width of pier
- $H_e$ : height of pier exposed to current
- $v$ : current speed

### 6.21.2 Specifying the pier resistance

If the resistance effect on the flow from bridge piers has to be included in the simulation, the position and geometrical layout of the piers must be specified.

This various information must be grouped together in a pier data file. A pier data file is a type 1 data file where the number of time steps in fact is the number of piers, i.e. the time axis in the data file is not a true time axis. In the same way, the spatial axis is not a true spatial axis, but merely a collection of data describing the pier.

The pier data file has the layout depicted in Figure 6.18.

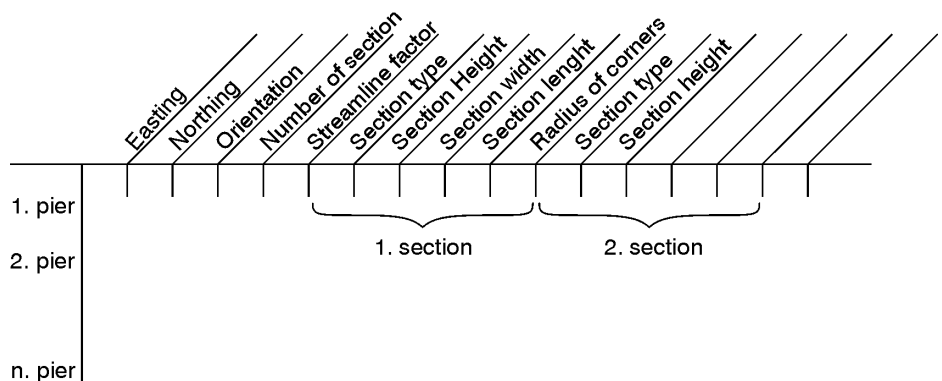

Figure 6.18 Layout of pier data file

The data file is created with the Profile Editor tool. In the following the parameters of the file are described:

- The x- and y-coordinates must be specified as map projection coordinates, e.g. UTM-33 coordinates.



**Note:** The map projection is defined by the Geographical Information in the data file (in Release 2007 and previous the projection system was defined by the item description, e.g. PROJ=UTM-33).

- The type 1 data file must have **Data Type=800**.

- The angle is measured from projection north to the alignment, positive clockwise and in degrees. Note that projection north is not the same as geographical north.
- The number of sections means the number of pier segments, i.e. the number of parts with different geometrical layout.
- The streamline factor is a factor that is multiplied on the total drag force to take into account the increased flow velocity due to the blocking of piers. A typical value is 1.02.
- The following five parameters describe the geometrical layout of one pier section. These five parameters have to be repeated at each section of the pier. The pier section type can be one of:
  - 0:circular
  - 1:rectangular
  - 2:elliptical

See Figure 6.19 and Figure 6.20 below for a definition sketch.

For a circular pier section please note: Both width and length should be equal to the diameter of the pier section and the parameter “Radius of rounded corners” is not used but should be assigned a value e.g. 0 or 1.

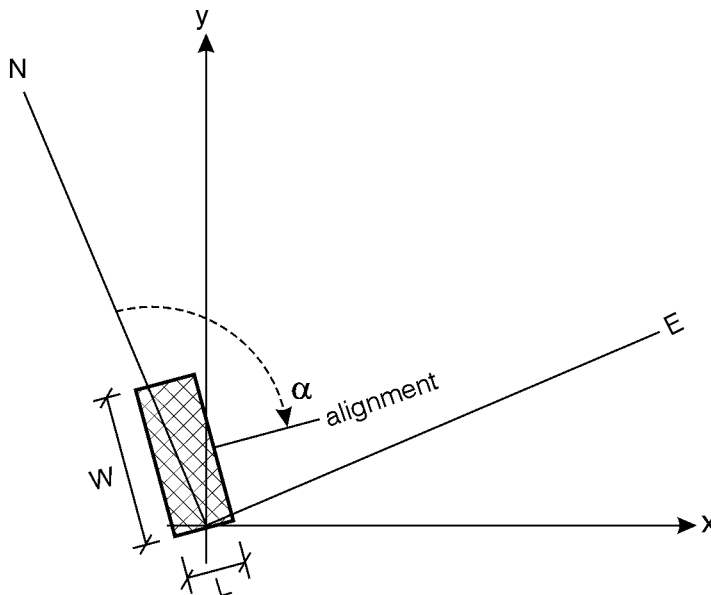

**W** : width of pier section  
**L** : length of pier section  
**α** : angle between projection north and alignment  
**x,y** : the MIKE 3 grid coordinate system

Figure 6.19 Pier definition sketch



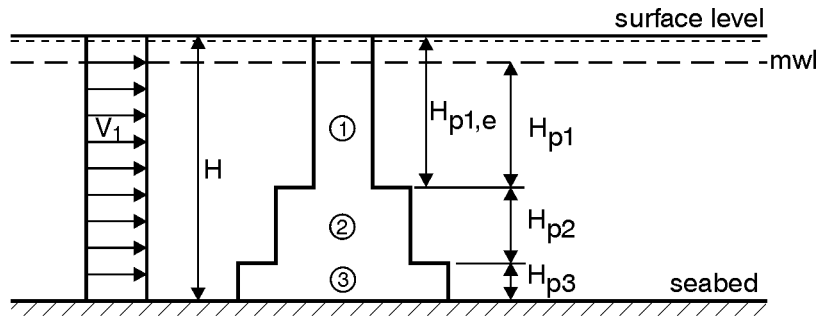

Example : Effective height for pier section:

$$H_{p1} = \max \{ (H - H_{p2} + H_{p3}), 0 \}$$

$$H_{p2} = \max \{ (H - H_{p3} - H_{p1e}), 0 \}$$

$$H_{p3} = \min (H_{p3}, H)$$

Figure 6.20 Definition sketch. Effective height

## 6.22 Precipitation

In applications where the rainfall is important for the flow, you can include precipitation in your simulation. This is done either as a constant value or as a time series (type 0 data file), which then is applied to the entire model area, or as a time series of maps (type 2 data file) in which case each grid point is assigned its own value. The precipitation rate is specified in mm/day. You can use the **Time Series Editor** or the **Grid Editor** tool to create your precipitation data.

You can also use the precipitation facility to include evaporation in your simulation. This is simply done by selecting the “included as net-precipitation” option and specifying a negative precipitation.

The precipitation rate is specified in the Source and Sink (*p. 31*) dialog.

## 6.23 Simulation Type

### 6.23.1 General description

There are two ways of starting your simulation:

- From scratch, also called a “cold start”, which means that you have to specify the model bathymetry as well as all other model parameters.



- As the continuation of a previous simulation, also called a “hot start”, in which case you must prepare “hot data” when doing the previous simulation. This is done by requesting that a file containing “hot data” be prepared in the Results dialog.

When your simulation is a continuation of a previous one, the bathymetry together with the additional area description from the previous simulation, is reused and cannot be changed. The rest of the model parameters you specify as for a “cold start”.

### 6.23.2 Remarks and hints

In most applications all simulations will be “cold started”. However, if you have very long simulations or your computer system often stops (planned or unplanned) it is wise to use the “hot start” facility.

## 6.24 Shear Stress

The shear stress which may be selected as output in the HD module is based on the equation

$$\tau = \frac{1}{2} f \rho V^2 \quad (6.12)$$

The relation between the friction factor  $f$  and the Chezy number  $C$  is

$$f = \frac{2g}{C^2} \quad (6.13)$$

Resulting in

$$\tau = \frac{g}{C^2} \rho V^2 \quad (6.14)$$

Or expressed using Manning’s  $M$

$$\tau = \frac{g}{M^2 h^{1/3}} \rho V^2 \quad (6.15)$$

The stress is a vector and may be output both as components in the x- and y-direction and by the absolute size.



## 6.25 Soft Start

### 6.25.1 General description

In order to avoid numerical shocks in the simulation it can often be a good idea to introduce the hydrographic forcing parameters in a gentle way. This is achieved by the “warm up” parameters.

### 6.25.2 Specifying soft start

The soft start parameter gives the number of time steps to be used in building-up the forcing parameters from zero to their specified value.

### 6.25.3 Remarks and hints



Note that level boundary conditions are not increased from a zero value but from the value indicated by the initial surface elevation.

## 6.26 Source and Sink

### 6.26.1 General description

The effects of rivers, intakes and outlets from power stations etc. can be included in a simulation. These sources and sinks are included in the hydrodynamic equations in the following way:

- If your source or sink has a magnitude of  $Q$  m<sup>3</sup>/s, then the additional term on the right hand side of the continuity equation is

$$Q / (\Delta x \cdot \Delta y)$$

- If, for sources, you specify a speed of  $V$  m/s in direction  $\theta$ , then the additional term on the right hand side of the momentum equations are

$$Q \cdot V \cdot \sin(\theta - \theta_{NYC}) \quad (\text{x-direction})$$

$$Q \cdot V \cdot \cos(\theta - \theta_{NYC}) \quad (\text{y-direction})$$

where  $\theta_{NYC}$  is the orientation of the model (see Orientation (p. 76)).



## 6.26.2 Specifying sources and sinks

In your model you can have up to a total of 256 sources and sinks. The sources and sinks are then numbered in succession and you specify (or edit) each of them by giving the corresponding number.

For a source you specify:

- The source location is specified as a constant in time and space.
- The source direction of the flow is specified as a constant in time and space.
- The source discharge and flow speed can be specified as a constant in time and space or as a time series. The discharge is given in  $\text{m}^3/\text{s}$  and the flow speed in  $\text{m}/\text{s}$ .

For the above specifications, the only requirement is that the source data be specified for the complete simulation period.

For a sink you specify:

- The location (in grid coordinates). The location is a constant in time and space.
- Either a constant intake (in  $\text{m}^3/\text{s}$ ) or the name of a data file as described for a source but with only one item, the intake discharge.

## 6.26.3 Remarks and hints

You should if possible avoid placing sources and sinks in points that are subjected to flooding and drying. If you have a source or sink in such a point, it will be inactivated when the point is dry during a sweep. But a separate mass budget is performed at all dried source/sink points such that the mass outlet/intake at a source/sink is correct. That is, for sources at dried points the mass outlet is accounted for until the particular point eventually floods (i.e. water depth increases the flooding depth) and thus enters the computations in the usual way. For sinks at dried points the sink intake is subtracted from the particular point until the water depths becomes very small (MIKE 21 cannot handle artificially generated non-positive water depths).

- **Note:** No flooding or drying must occur in the common grids along borders between areas.



## 6.27 Structures

### 6.27.1 Location of a structure

The location of a structure is given by a number of geo-referenced points which together make up a poly-line. The poly-line defines the width of the structure perpendicular to the flow direction e.g. for a weir it will describe the location of the crest in the horizontal plan view. For a culvert the poly-line should be given as a line perpendicular to the flow direction and further the line should intersect the mid point of the culvert.

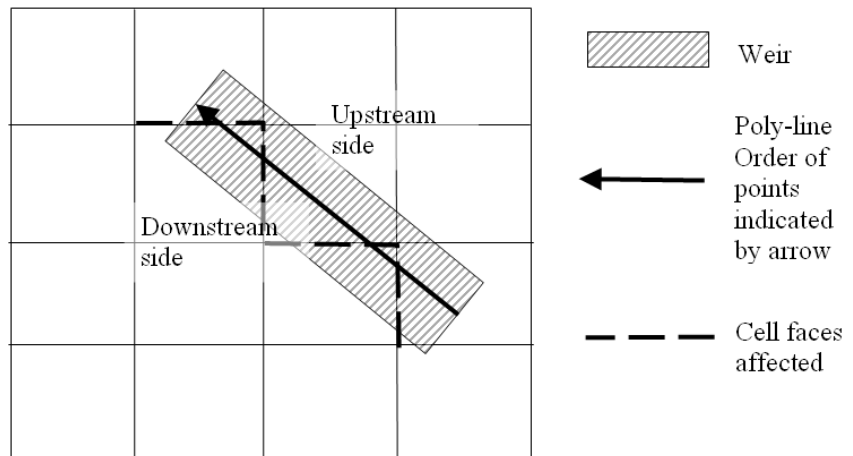

Figure 6.21 The location of a weir. Note the affected cell faces

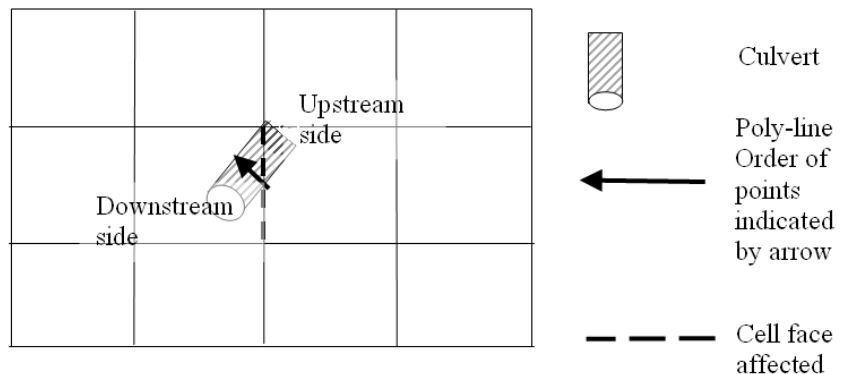

Figure 6.22 The location of a culvert. Note the affected cell face

A cell face is affected if the defining poly-line intersects the line segment connecting the mid points of the two adjacent grid cells. The flow through the structure is evenly distributed along the affected cell faces.

## 6.27.2 Weirs

There are three types of weirs available

- Broad crested weir
- Weir formula 1
- Weir formula 2

The geometry of each of these is to be supplied by the user according to the sections below.

### Broad crested weir

For a broad crested weir the user describes the shape of the “hole” through a level/width table (see figure below). The datum value for the structure may be used to shift the levels by a constant amount. The latter is typically used if the weir geometry has been surveyed with respect to a local benchmark.

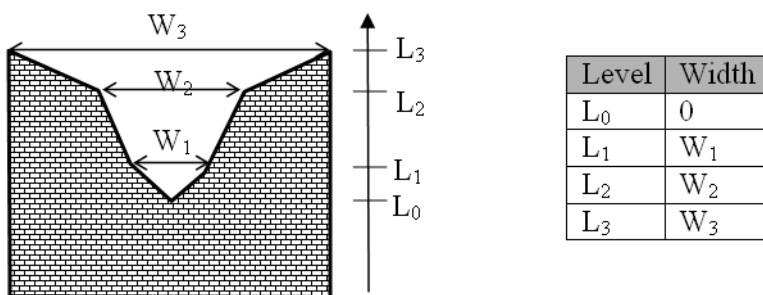

Figure 6.23 Definition sketch of broad crested weir geometry

The standard formulations for flow over a broad crested weir are established automatically by the program on the basis of the weir geometry and the user specified head loss and calibration coefficients. These formulations assume a hydrostatic pressure distribution on the weir crests. Different algorithms are used for drowned flow and free overflow, with an automatic switching between the two.

### Weir formula 1

For the weir formula 1 description the parameters are given by Figure 6.24. The width is perpendicular to the flow direction. Typically the invert level coincides with the overall datum.



Weir formula 1 is based on a standard weir expression, reduced according to the Villemonte formula:

$$Q = WC(H_{us} - H_w)^k \left[ 1 - \left( \frac{H_{ds} - H_w}{H_{us} - H_w} \right)^{0,385} \right] \quad (6.16)$$

where  $Q$  is discharge through the structure,  $W$  is width,  $C$  is weir coefficient,  $k$  is the weir exponential coefficient,  $H_{us}$  is upstream water level,  $H_{ds}$  is downstream water level and  $H_w$  is weir level (see Figure 6.24).

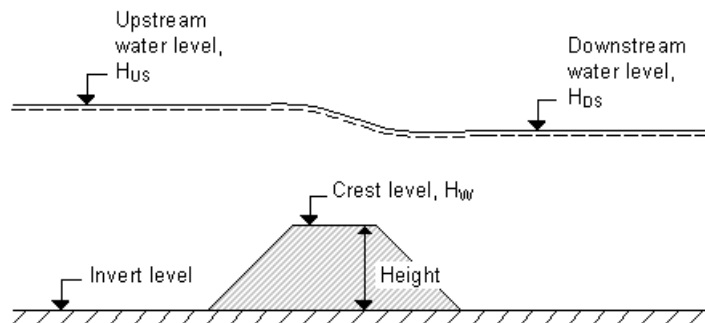

Figure 6.24 Definition sketch for weir flow

## Weir formula 2

For the weir formula 2 the geometry is given by a crest level and a width. The crest level is taken with respect to the global datum. The width is perpendicular to the flow direction.

Weir formula 2 is the Honma formula:

$$Q = \begin{cases} C_1 W(H_{us} - H_w) \sqrt{(H_{us} - H_w)} & \text{for } (H_{ds} - H_w)/H_{us} < 2/3 \\ C_2 W(H_{ds} - H_w) \sqrt{(H_{us} - H_{ds})} & \text{for } (H_{ds} - H_w)/H_{us} \geq 2/3 \end{cases} \quad (6.17)$$

where  $Q$  is the discharge through structure,  $W$  is the width,  $C_1$  is the weir coefficient 1, and  $C_2$ , the weir coefficient 2, is calculated according to  $C_2 = 1,5\sqrt{3}C_1$ ,  $H_{us}$  is the upstream water level,  $H_{ds}$  is the downstream water level and  $H_w$  is weir level (see Figure 6.24).



## Head Loss Factors

The flow description generally used for a structure is given by:

$$\Delta H = \zeta_t \frac{V_s^2}{2g} \quad (6.18)$$

where  $\Delta H$  is the energy loss over the structure,  $\zeta_t$  is the total head loss coefficient and  $V_s$  is the mean cross sectional velocity at the structure.

The total head loss coefficient ( $\zeta_t$ ) is composed of entrance ( $\zeta_1$ ) and exit ( $\zeta_2$ ) coefficients. The coefficients are generally related to the input parameters for Inflow ( $\zeta_{in}$ ) and Outflow ( $\zeta_{out}$ ) and the changes in velocity ( $v$ ) and area ( $A$ ):

$$\zeta_t = \zeta_1 + \zeta_2 = \zeta_{in} \left( \frac{V_1}{V_s} \right) + \zeta_{out} \left( \frac{A_s}{A_2} \right)^2 \quad (6.19)$$

where suffix '1' and '2' represents velocity and Area on inflow and outflow side of structure respectively, and 's' represents the velocity and Area in the structure itself.

For subcritical flow through a structure there is an upstream contraction and a downstream expansion, so the above equation works fine.

However, in the present implementation, upstream and downstream cross sections are not extracted and accordingly, tabulated relations on cross section areas as function of water levels are not known. Instead, upstream and downstream areas are set to a large number resulting in a full loss contribution from the head loss factors defined. Viz,

$$\zeta_t = \zeta_1 + \zeta_2 = \zeta_{in} + \zeta_{out} \quad (6.20)$$

Care must be taken when selecting loss coefficients, particularly in situations where both subcritical and supercritical flow conditions occur. When flow conditions change from subcritical to supercritical (or the Froude number  $FR$  becomes greater than 1), the loss coefficients  $\zeta_{in}$  and  $\zeta_{out}$  (specified in the Head Loss Factors box) are modified:

- If  $FR > 1$  in upstream h-point then  $\zeta_{in} = \zeta_{in} / 2$
- If  $FR > 1$  in downstream h-point then  $\zeta_{out} = \zeta_{out} / 2$

### Free Overflow Head Loss Factor

The critical flows (and orifice flows for culverts as well) are multiplied by the critical flow correction factor,  $\alpha_c$ , specified as the Free Overflow Head Loss Factor. Typically a value of 1.0 is used.





### 6.27.3 Culverts

A culvert may be of three different geometries:

- Rectangular
- Circular
- Irregular (A level-width table)

#### Geometry

With the rectangular and the circular type geometries the width/height or the diameter is supplied.

For the Irregular type geometry the geometry is to be defined through a level-width relationship table, see Figure 6.25. Further the user must supply the invert levels of the culvert on the upstream and on the downstream side. The invert is the lowest point in the inlet/outlet section. Note that the values in the level width table are taken with respect to the inverts. Further the user must supply the length of the culvert (in the flow direction) and the resistance in the culvert. The latter is defined through the use of Manning's  $n$  ( $=1/M$ ).

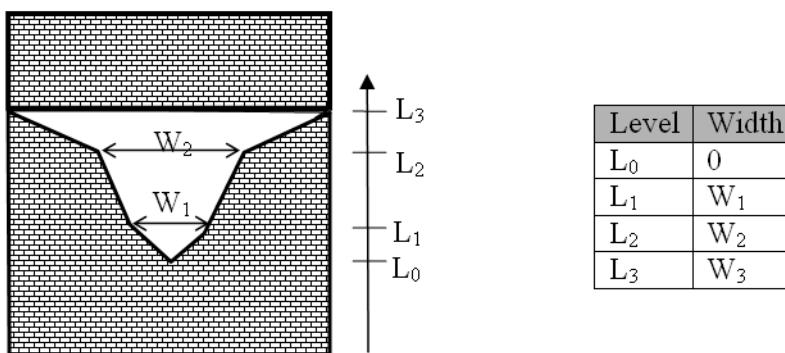

Figure 6.25 Definition sketch of irregular level-width culvert geometry

#### Closed / Open Section switch

A culvert structure can be modelled as an open section if required by setting the Closed / Open switch. An example where this may be used is a “long” weir where the friction along the length of the weir is of importance and/or the flow areas at the entrance and exit are significantly different.

If set to open the culvert will never run full or partially full, therefore only those flow conditions which represent a free water surface are modelled. When the water level is higher than the soffit the hydraulic parameters are calculated based on a section extended vertically upwards with a width equal to that at



the soffit. For example, in the case of a rectangular section the height value is essentially redundant as the cross-section will be modelled as an open section of constant width.

In the case of a circular section, this switch is invalid and will be set to closed.

## Head loss factors

The total head loss,  $DH$  through a culvert is given by:

$$\Delta H_{loss} = \frac{Q^2}{2g} \left( \frac{\zeta_1}{A_{s_1}^2} + \frac{\zeta_f + \zeta_b}{A_{s_a}^2} + \frac{\zeta_2}{A_{s_2}^2} \right) \quad (6.21)$$

where  $A_s$  is the mean cross section area along the length of the culvert and  $Q$  is the discharge,  $\zeta_1$  is the entrance or contraction loss,  $\zeta_2$  is the outlet or expansion loss,  $\zeta_f$  is the Friction loss calculated using the Manning formula and  $\zeta_b$  is the bend loss coefficient.

$$\zeta_1 = \zeta_{in} \left( 1 - \frac{A_{s_1}}{A_1} \right) \quad (6.22)$$

$$\zeta_2 = \zeta_{out} \left( 1 - \frac{A_{s_2}}{A_2} \right)^2 \quad (6.23)$$

$$\zeta_f = \frac{2gLn^2}{R^{4/3}} \quad (6.24)$$

where  $L$  is the culvert length,  $n$  is Manning's coefficient and  $R$  is the mean Hydraulic Radius along the culvert. The Manning's  $n$ -value depends on the interior surface of the culvert. Table values can be found in literature. For e.g. a concrete culvert  $n$  would typically range from 0.011 to 0.017.

The bend loss coefficient,  $\zeta_b$ , is provided for situations where head losses other than from the above occur, for example bends, damaged culverts, trapped debris. For straight culverts in good condition a value of zero would apply.

### Free overflow head loss factor

The critical flows (and orifice flows for culverts as well) are multiplied by the critical flow correction factor,  $\alpha_c$ , specified as the Free Overflow Head Loss Factor. Typically a value of 1.0 is used.



## 6.27.4 Dikes

The flow,  $Q$ , over a section of the dike corresponding to an element face with the length (width),  $w$ , is based on a standard weir expression, reduced according to the Villemonte formula:

$$\begin{aligned}
 Q &= wC(H_{us} - H_w)^{3/2} \left( 1 - \left( \frac{H_{ds} - H_w}{H_{us} - H_w} \right)^{3/2} \right)^{0,385} && \text{for } H_{us} > H_{ds} > H_w \\
 Q &= wC(H_{us} - H_w)^{3/2} && \text{for } H_{us} > H_w \geq H_{ds} \\
 Q &= 0 && \text{for } H_w \geq H_{us} > H_{ds}
 \end{aligned}
 \tag{6.25}$$

where  $Q$  is discharge through the structure,  $w$  is the local width (cell face width),  $C$  is discharge coefficient,  $H_{us}$  is upstream water level,  $H_{ds}$  is downstream water level and  $H_w$  is the crest level taken with respect to the global datum (see Figure 6.26). The default value of the weir coefficient is 1.838.

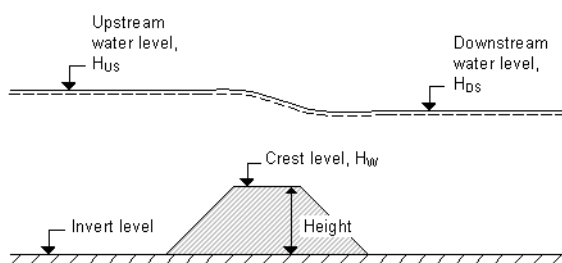

Figure 6.26 Definition sketch for Dike Flow

The geometry of a dike is defined as shown below.

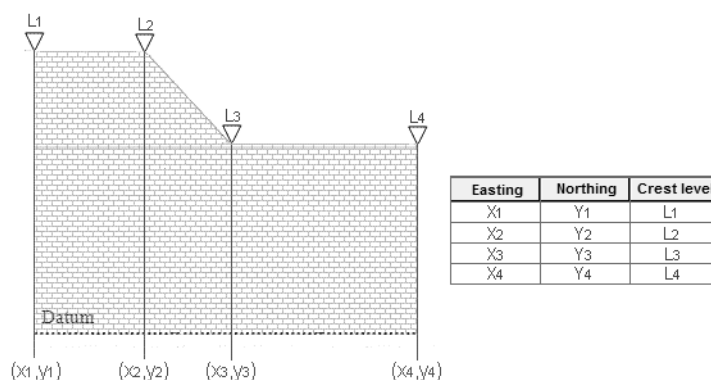

Figure 6.27 Definition sketch of spatial varying dike geometry

### 6.27.5 Flow directions for specific structure parameters

Positive and Negative flow directions as referred to in Valve and Head loss coefficient definitions follows the definition as presented in Figure 6.28. That is, positive flow direction is defined as the left perpendicular to the direction of a structure line schematisation.

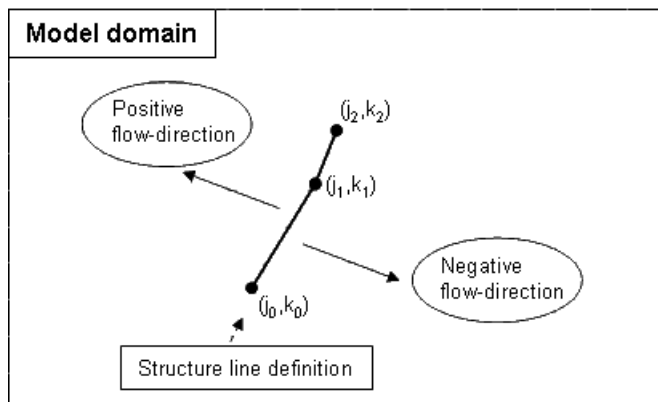

Figure 6.28 Positive and Negative flow direction definition at structures

### 6.27.6 Remarks and hints

To ensure that a structure is mapped properly onto one or more cell faces the defining poly-line should intersect the line segments connecting the cell centres. If the latter is not the case a warning is issued in the simulation-log and the structure is mapped onto the nearest cell face with a similar alignment as the defining line segment. To ensure a proper mapping simply extend the poly-line defining the structure location so that it intersects a line segment connecting cell mid-points, see Figure 6.29

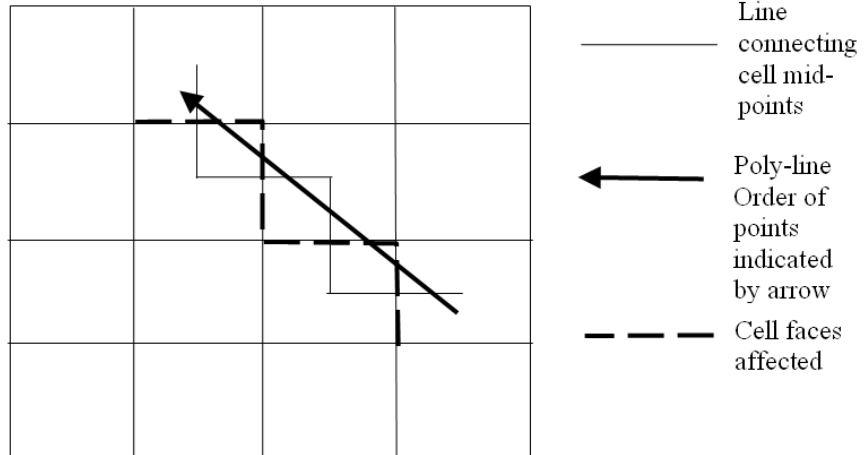

Figure 6.29 Definition of cell mid-points

The affected cell faces are written to the simulation log for inspection. The format being:

**n**      **j**      **k**      **Top**      **Posi**

**n** is an index of the number of cells affected, **j** and **k** refers to the individual cells. The value of **Top** is either 0 or 1 depending on whether the cell face is to the right or at the top of the cell. Finally the **Posi** value indicates whether the cell is the upstream (1) or the downstream side of the structure. Please note that the upstream and downstream definition is only of importance if the loss factors are asymmetric across the structure or the invert levels are different upstream and downstream.

## 6.28 Time Step

### 6.28.1 Selecting the time step

The time step for your simulation is selected as follows:

- First you determine the grid spacing,  $\Delta x$ .
- Secondly you decide on the maximum allowed Courant number,  $C_r$ , as described under Courant Number (p. 66).



- Then you can determine the maximum time step,  $\Delta t_{max}$ , which can be used in the model from the definition of the Courant number:

$$\Delta t_{max} = \Delta x \frac{C_r}{c} \quad (6.26)$$

where  $c$  is the celerity (see Courant Number (p. 66) for a description). The time step to be used in the model,  $\Delta t$ , can then be chosen as a “convenient” number not greater than  $\Delta t_{max}$ .

- Finally you have to check that the Courant number based on the current speed, (the transport Courant number)  $C_{r,U}$ , instead of the wave celerity, is less than 1 for the time step chosen. If not, you must reduce the chosen time step.  $C_{r,U}$  is defined as

$$C_{r,U} = \Delta t \cdot \left( \frac{U}{\Delta x} + \frac{V}{\Delta y} \right) \quad (6.27)$$

where  $U, V$  is the current speed in the  $x$ -direction and  $y$ -direction. For all points within the model  $U$  and  $V$  must follow the above formula. As you have not yet carried out the simulation you will have to make an estimate and then check this after the simulation.



**Please note** that formally  $U$  and  $V$  in the above expression should be replaced by  $P/H$  and  $Q/H$ , respectively, where  $P$  and  $Q$  are the magnitudes of the fluxes in the  $x$ - and  $y$ - directions and  $H$  is the local water depth. Often the two expressions – based on current speeds or on the flux magnitudes – yield almost the same value, but care should be taken in models with large surface and/or bottom gradients.

## 6.29 Velocity

The output velocity is a vector and various types of velocity information may be selected as output in the HD module:

- U-velocity (in the direction of the  $x$ -axis)
- V-velocity (in the direction of the  $y$ -axis)
- Current speed (absolute size)
- Current direction (measured positive clockwise from True North)



## 6.30 List of References

- Aupoix, B. Eddy Viscosity Subgrid Scale Models for Homogeneous Turbulence, in *Macroscopic Modelling of Turbulent Flow*, Lecture Notes in Physics, Proc. Sophie-Antipolis, France, 1984.
- Fredsøe, J. Turbulent boundary layers in Combined Wave Current Motion. J. Hydraulic Engineering, ASCE, Vol 110, No. HY8, pp. 1103-1120, 1984.
- Horiuti, K. Comparison of Conservative and Rotational Forms in Large Eddy Simulation of Turbulent Channel Flow, *Journal of Computational Physics*, **71**, pp 343-370, 1987.
- Jones, O., Zyserman, J.A. and Wu, Yushi. Influence of Apparent Roughness on Pipeline Design Conditions under Combined Waves and Current, *Proceedings of the ASME 2014 33rd International Conference on Ocean, Off-shore and Arctic Engineering*, 2014.
- Kofoed-Hansen, H., Giménez, E.C. and Kronborg, P. Modelling of landslide-generated waves in MIKE 21, *4th DHI Software Conference*, 2001.
- Leonard, A. Energy Cascades in Large-Eddy Simulations of Turbulent Fluid Flows, *Advances in Geophysics*, **18**, pp 237-247, 1974.
- Lilly, D.K. On the Application of the Eddy Viscosity Concept in the Inertial Subrange of Turbulence, *NCAR Manuscript No. 123*, National Center for Atmospheric Research, Boulder, Colorado, 1966.
- Madsen, P.A., Rugbjerg, M. and Warren, I.R. Subgrid Modelling in Depth Integrated Flows, *Coastal Engineering Conference*, **1**, pp 505-511, Malaga, Spain, 1988.
- Rodi, W. Turbulence Models and Their Application in Hydraulics - A State of the Art Review, *Special IAHR Publication*, 1980.
- Smagorinsky, J. General Circulation Experiment with the Primitive Equations, *Monthly Weather Review*, **91**, No. 3, pp 99-164, 1963.
- Wang, J.D. Numerical Modelling of Bay Circulation, *The Sea, Ocean Engineering Science*, **9**, Part B, Chapter 32, pp 1033-1067, 1990.







# INDEX



<b>B</b>	
Bridge . . . . .	43
<b>C</b>	
Cell face . . . . .	35, 92
Cold start . . . . .	26
Composite structures . . . . .	43
Culvert . . . . .	37
Current . . . . .	94
<b>D</b>	
Data type . . . . .	77
Dike . . . . .	40
<b>E</b>	
Evaporation . . . . .	31, 68
<b>F</b>	
Froude number . . . . .	70
<b>H</b>	
Hot start . . . . .	26
<b>I</b>	
Infiltration . . . . .	32
Inland flooding . . . . .	69
Inundation statistics . . . . .	73
<b>L</b>	
Leakage . . . . .	33
<b>M</b>	
Multi-cell overland solve . . . . .	74
Multi-cell overland solver . . . . .	26
<b>P</b>	
Precipitation . . . . .	31, 81
<b>R</b>	
Rating curve . . . . .	30
Rural area . . . . .	26
<b>S</b>	
Shear stress . . . . .	82
Speed . . . . .	94
<b>U</b>	
Urban area . . . . .	26
<b>V</b>	
Velocity . . . . .	94
<b>W</b>	
Weir . . . . .	35